

PRODUCT NUMBER
SEE PART NO. TABLE

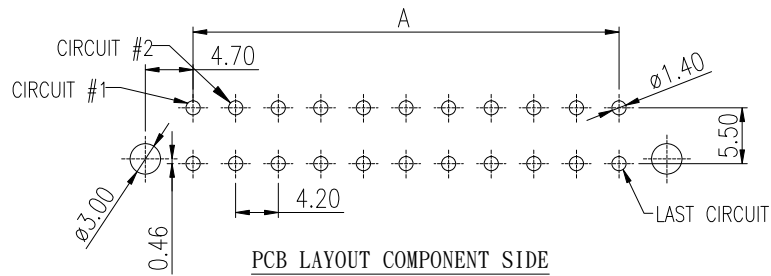
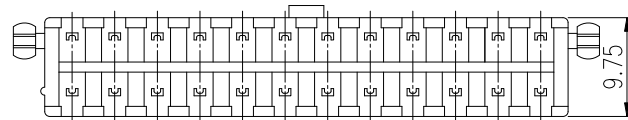
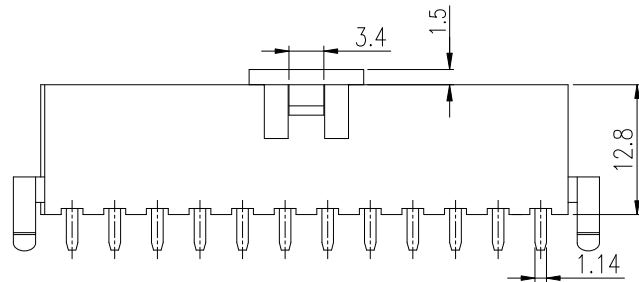
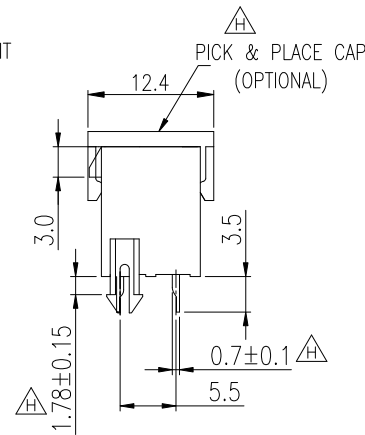
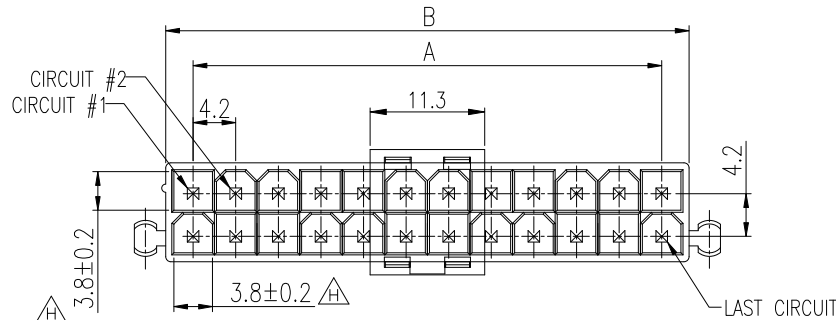

NOTES:

- MATERIAL:
HSG: OPTIONAL, UL94V-0.
COLOR: NATURAL.
TERMINAL: BRASS.
PLATING: OPTIONAL ON CONTACT AREA.
PICK & PLACE CAP: HIGH TEMP. THERMOPLASTIC WIRE CONNECTOR 10127815.
- THIS PLUG MATES WITH FCI RECEPTACLE WIRE CONNECTOR 10127815.
- PRODUCT SPECIFICATION: GS-12-1181.
- PACKAGE SPECIFICATION: GS-14-2362.
- THE HOUSING WILL WITHSTAND EXPOSURE TO 235°C PEAK TEMPERATURE FOR 5 SECONDS IN A WAVE SOLDER APPLICATION WITH A 1.6mm MINIMUM THICK CIRCUIT BOARD. (FOR PA66)
THE HOUSING WILL WITHSTAND EXPOSURE TO 260 °C PEAK TEMPERATURE FOR 10 SECONDS IN A REFLOW OVEN. (FOR LCP ONLY)
- PART NUMBER SCHEME:

10127820- XX X X X X X LF

POS. CODE:
02: 2 POS.
04: 4 POS.
24: 24 POS.

TERMINAL MATERIAL:
2: BRASS

PLATING CODE:
1: GOLD FLASH
2: TIN

CAP: (NOT APPLICABLE FOR 2 POS.)
BLANK: NO CAP, TRAY PACKAGE
C: WITH CAP, TAPE/REEL PACKAGE

PEG:
BLANK: NO PEG
P: 2 PEGS

GLOW WIRE COMPATIBLE:
BLANK: PA66, NON COMPATIBLE
G: PA66, COMPATIBLE
L: LCP, COMPATIBLE

7. DIMENSIONAL & PART NO. TABLE:

PART NUMBER	POS.	A	B
10127820-02XXXXLF	02		5.4
10127820-04XXXXLF	04	4.2	9.6
10127820-06XXXXLF	06	8.4	13.8
10127820-08XXXXLF	08	12.6	18.0
10127820-10XXXXLF	10	16.8	22.2
10127820-12XXXXLF	12	21.0	26.4
10127820-14XXXXLF	14	25.2	30.6
10127820-16XXXXLF	16	29.4	34.8
10127820-18XXXXLF	18	33.6	39.0
10127820-20XXXXLF	20	37.8	43.2
10127820-22XXXXLF	22	42.0	47.4
10127820-24XXXXLF	24	46.2	51.6

mat'l. code				surface		tolerance		projection		product family			
ltr				ecn no		dr		date		Minitek Pwr4.2			
H				ELX-T-20468		TAI		2015-03-16		title			
										MINITEK PWR4.2, WT B HEADER, DUAL ROW, VERTICAL, DIP TYPE			
C				ELX-T-17193		TAI		2014-03-12		scale			
D				ELX-T-17526		TAI		2014-04-17		dr			
E				ELX-T-17590		TAI		2014-04-29		KENNY TAI			
F				ELX-T-19251		TAI		2014-10-31		KENNY TAI			
G				ELX-T-20255		TAI		2015-02-12		PM ZHENG			
sheet		revision		H		H							
index		sheet		1		2							



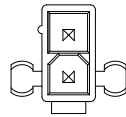

2 POS

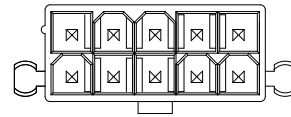

10 POS

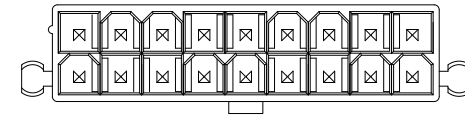

18 POS

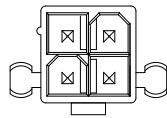

4 POS

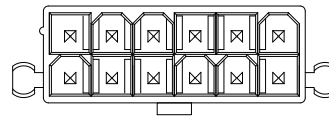

12 POS

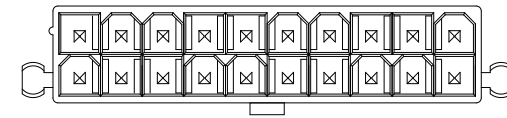

20 POS

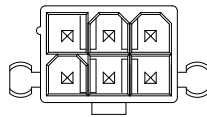

6 POS

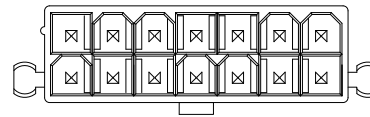

14 POS

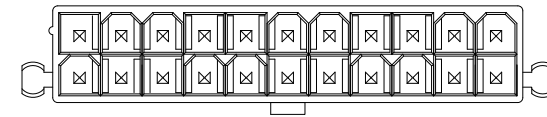

22 POS

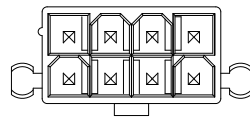

8 POS

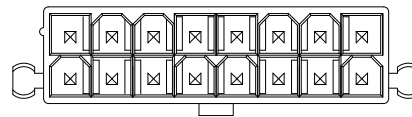

16 POS

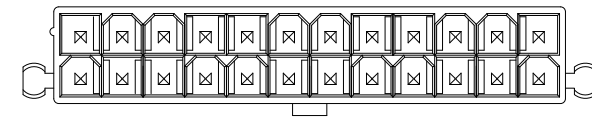

24 POS

mat'l. code		surface <input checked="" type="checkbox"/>		tolerance		projection		product family		
ltr		ecn no		date		 MM		Minitek Pwr4.2		
						 scale		title		
								MINITEK PWR4.2, WTB HEADER, DUAL ROW, VERTICAL, DIP TYPE		
								dwg no		
								sheet 2 of 2		size
								10127820		A4
								type		CUSTOMER Drawing
sheet index		revision sheet		H H						
				1 2						