

PRODUCT NUMBER
SEE PART NO. SCHEME

NOTES:

- MATERIALS:
HOUSING: LCP, UL94V-0, BLACK
TERMINAL: COPPER ALLOY
- FINISH:
TERMINAL: SEE PART NO. SCHEME
UNDER PLATING: NICKEL OVERALL
- PRODUCT SPECIFICATION: GS-12-1177
- PACKAGE SPECIFICATION: GS-14-2359
- THIS PART MATES WITH FCI RECEPTACLE WIRE CONNECTOR 10136653
- THIS PART IS APPLICABLE FOR WAVE SOLDERING WITH A 1.6mm THICKNESS PCB, AND APPLICABLE FOR 260°C 5 SEC. REFLOW SOLDERING PROCESS.
- DIMENSION TABLE:

12	39.65	33.0	39.0
11	36.65	30.0	36.0
10	33.65	27.0	33.0
09	30.65	24.0	30.0
08	27.65	21.0	27.0
07	24.65	18.0	24.0
06	21.65	15.0	21.0
05	18.65	12.0	18.0
04	15.65	9.0	15.0
03	12.65	6.0	12.0
02	9.65	3.0	9.0
POS.	A	B	C

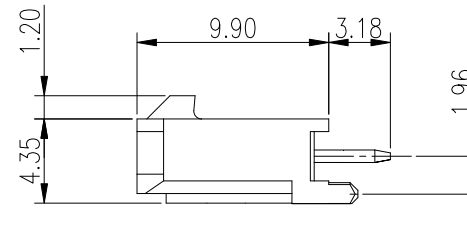
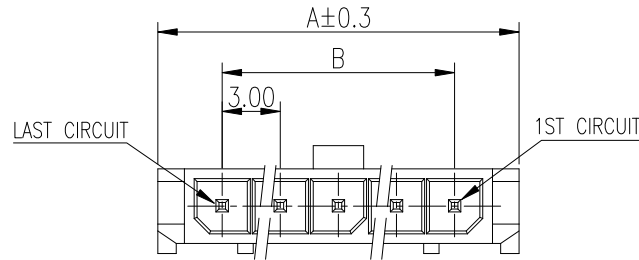
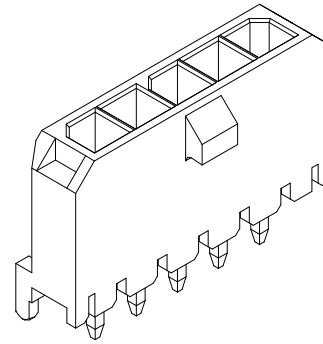
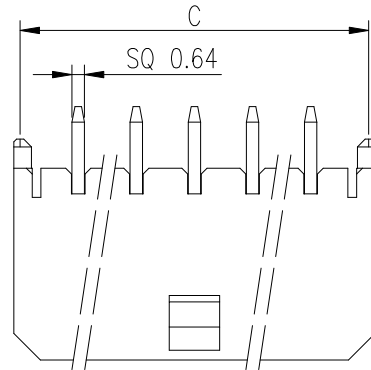

PART NUMBER SCHEME:
10136656-XX X X LF

NO OF POS.
02: 2 POS.
12: 12 POS.

HSG MATERIAL, GLOW WIRE COMPATIBLE
1. COMPATIBLE
2. NON COMPATIBLE

PLATING
1. TIN
2. GOLD FLASH
3. 15u" Au, TIN ON TAILS
4. 30u" Au, TIN ON TAILS

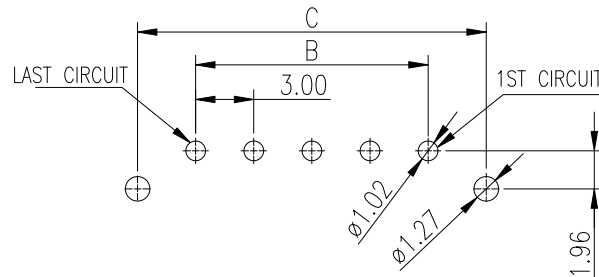

RECOMMENDED PCB LAYOUT: COMPONENT SIDE
THICKNESS: 1.60±0.05mm (TOLERANCE: ±0.05)

mat'l. code		surface		tolerance	projection	product family	
		✓			⊕	MINITEK PWR3.0	
ltr	ecn no	dr	date	tolerances unless otherwise specified		title	
A		TAI	2015-09-23	angles	X.X ±0.3	MINITEK PWR3.0 VERTICAL HEADER, SINGLE ROW, THROUGH HOLE	
				radius	X.XX ±0.2	scale	
				X°±2°		dwg no	
		dr	KENNY TAI	2015-08-21		sheet 1 of 2	
		enr	KENNY TAI	2015-08-21		size	
		chr	KENNY TAI	2015-08-28		10136656	
		appd	PM ZHENG	2015-09-23		A4	
sheet index		revision sheet	A	A	type		CUSTOMER Drawing
			1	2			

PRODUCT NUMBER
SEE PART NO. SCHEME

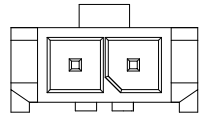

2 POS

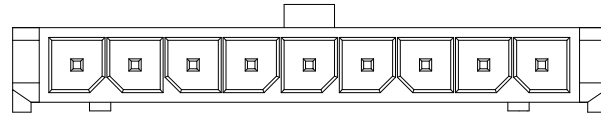

9 POS

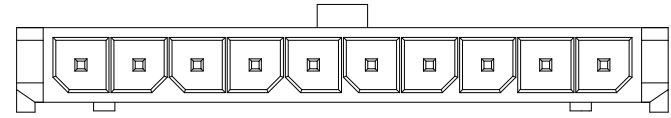

10 POS

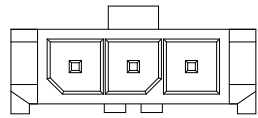

3 POS

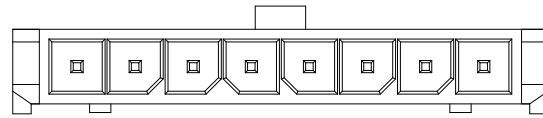

8 POS

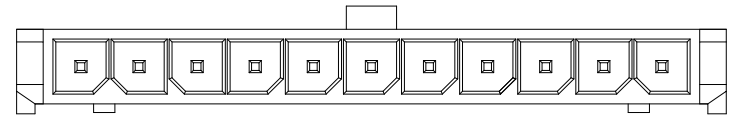

11 POS

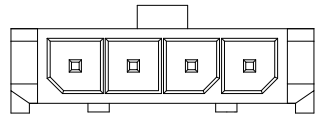

4 POS

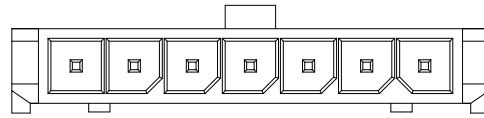

7 POS

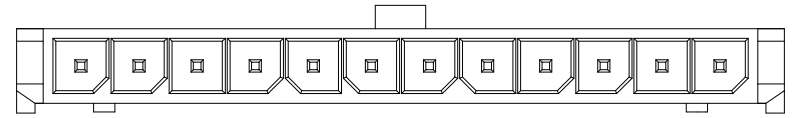

12 POS

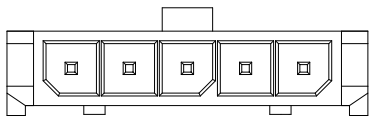

5 POS

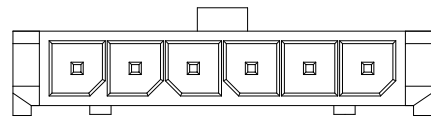

6 POS

mat'l. code		surface		tolerance		projection		product family		
		✓				⊕		MINITEK PWR3.0		
ltr	ecn no	dr	date	tolerances unless otherwise specified		MM		title		
				angles	X.X ±0.3	← MM →		MINITEK PWR3.0 VERTICAL HEADER, SINGLE ROW, THROUGH HOLE		
				linear	X.XX ±0.2	scale		dwg no		
				X°±2°				sheet 2 of 2		
				dr	KENNY TAI	2015-08-21	FCI		size	
				enr	KENNY TAI	2015-08-21			A4	
				chr	KENNY TAI	2015-08-28			10136656	
				appd	PM ZHENG	2015-09-23			type	
								CUSTOMER Drawing		
sheet index	revision sheet	A	A							
		1	2							