

PRODUCT NUMBER
SEE SHT. 2

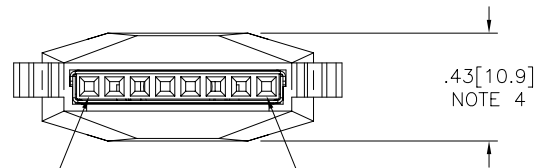
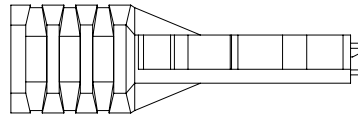
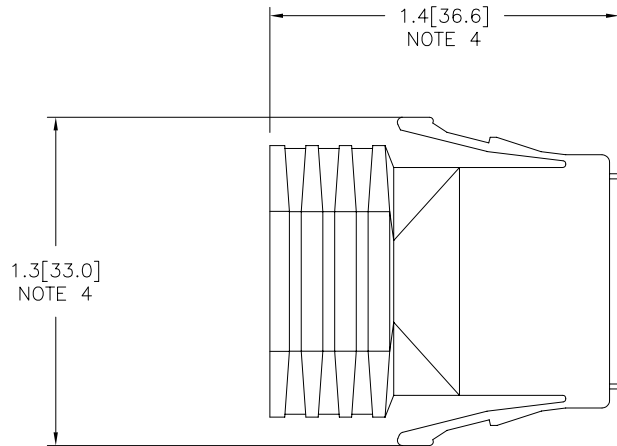

POSITION #1

POSITION #8

mat'l. code				surface ISO 1302 ✓		tolerance ISO 406 ISO 1101		projection FIRST ANGLE		product family LATCH-N-LOK			
D V91916 TGD 10/7/99				tolerances unless otherwise specified		.XX±.01/.3		INCH/MM		title 1X8 LATCH-N-LOK 360° SHIELDED PLUG CONN. KIT W/O PV'S			
E V92065 RGD 10/29/99				angles		linear .xxx±.005/.13		scale 1:1		dwg no 74903			
F V01017 TFG 5/15/00				0°±2'		.xxxx±.0020/.051				sheet 1 of 3 size A3			
G V01050 TFG 6/5/00				dr		M. HERNANDEZ 12/03/04		FCJ		type Product Customer Drawing			
H V01093 TFG 7/6/00				engr		M. BARRIOS 12/03/04							
J M04-0229 MHT 12/03/04				chr		M. BARRIOS 12/03/04							
K M06-0365 AGS 9/20/06				appd		M. BARRIOS 12/03/04							
sheet		revision		K		K		K					
index		sheet		1		2		3					

FCJ
FCIconnect.com

Copyright FCI

74903-TUVLF

U	COLOR	
01	LT-GRAY	OBS
02	OFF WHITE	
03	DK- GRAY	OBS
04	BLACK	
05	SLATE-GRAY	OBS
07	SILVER GRAY	
08	PEARL- WHITE	OBS
09	PEBBLE GRAY	

T	HOLE DIA.
7	.265/6.73
9	.312/7.92

EXAMPLE

74903-707LF: IS A 1x8 REAR EXIT PLUG
 IN SILVER GRAY WITH A CABLE EXIT
 HOLE SIZE OF .265 [6.73] CABLE RANGE ,



Copyright FCI

mat'l. code		surface ISO 1302 <input checked="" type="checkbox"/>		tolerance ISO 406 ISO 1101		projection 		product family LATCH-N-LOK	
ltr	ecn no	dr	date	tolerances unless otherwise specified				title	
K				angles	linear	.XX±.01/.3 .xxx±.005/.13 .xxxx±.0020/.051		1X8 LATCH-N-LOK 360° SHIELDED PLUG CONN. KIT W/O PV'S	
				0°±2'		scale 1:1		dwg no	
		dr	M. HERNANDEZ	12/03/04					sheet 2 of 3 size
		enr	M. BARRIOS	12/03/04			74903		A3
		chr	M. BARRIOS	12/03/04			type		Product Customer Drawing
		app	M. BARRIOS	12/03/04					
sheet index	revision sheet								

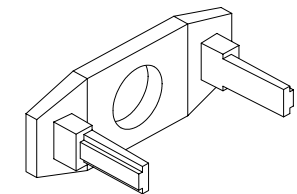

REAR CAP

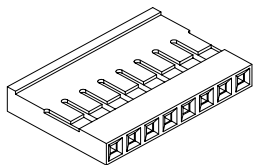

MINI LATCH HOUSING

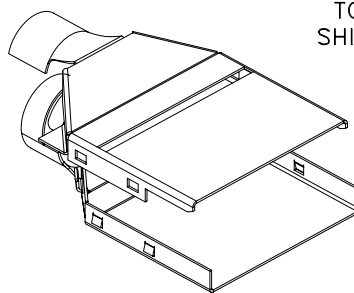

TOP SHIELD

BOTTOM SHIELD

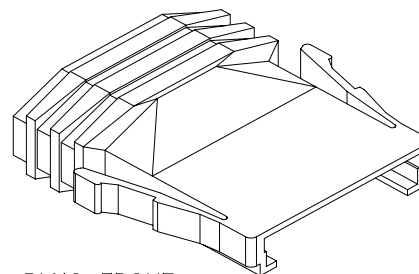

PLUG FRONT

NOTES:

- ① EACH KIT CONTAINS ONE EACH OF THE FOLLOWING COMPONENTS
LATCH-N-LOK PLUG
LATCH-N-LOK END CAP
MINI LATCH HOUSING
360° SHIELD CANS.
- 2. COMPONENTS ARE BULK PACKAGED WITH 100 pcs. OF A COMPONENT PER BAG. PVC'S MUST BE ORDERED SEPARATELY.
- 3. MATERIALS USED: PLUGS AND CAPS ARE MOLDED IN POLYCARBONATE. THE MINI LATCH HOUSING ARE MOLDED IN NYLON. COLOR IS BLACK. THE SHIELD CAN IS 3/4 HARD BRASS PLATED WITH 2.5um MIN. BRIGHT TIN. 1.0um MIN. NICKEL UNDERPLATE.
- ④ DIMENSIONS ARE APPROXIMATE AND REFLECT PLUG IN UNLATCHED STATE.
- 5. PART NUMBERS WITH LF IN THE END ARE LEAD FREE.
- 6. THIS PRODUCT MEETS EUROPEAN UNION DIRECTIVES AND OTHER COUNTRY REGULATION AS DESCRIBED IN GS-22-008.



FCIconnect.com

Copyright FCI

mat'l. code		surface ISO 1302 ✓		tolerance ISO 406 ISO 1101		projection ⊕		product family LATCH-N-LOK	
ltr	ecn	no	dr	date	tolerances unless otherwise specified		INCH/MM	title	
K					angles	.XX±.01/.3		scale 1:1	1X8 LATCH-N-LOK 360° SHIELDED PLUG CONN. KIT W/O PV'S
					0'±2'	linear .xxx±.005/.13			dwg no
						.xxx±.0020/.051		sheet 3 of 3 size	
					dr	M. HERNANDEZ	12/03/04	74903	
					enr	M. BARRIOS	12/03/04	A3	
					chr	M. BARRIOS	12/03/04	type	
					app	M. BARRIOS	12/03/04	Product Customer Drawing	
sheet	revision								
index	sheet								