

# 500mA Low Dropout Linear Regulator

## FEATURES

- Low Dropout Voltage of 650mV at 500mA Output Current (3V Output Version).
- Guaranteed 500mA Output Current.
- Low Ground Current at 65 $\mu$ A.
- 2% Accuracy Output Voltage of 1.8V/ 2.0V /2.5V /2.7V/ 3.0V/ 3.3V/ 3.5V/ 3.7V/ 3.8V/ 5.0V/ 5.2V.
- Only needs 4.7 $\mu$ F Output Capacitor for Stability.
- Current and Thermal Limiting.

## APPLICATIONS

- CD-ROM Drivers.
- LAN Cards.
- Microprocessor.
- RAM Module.
- Wireless Communication Systems.
- Battery Powered Systems.

## DESCRIPTION

The AIC1735 is a 3-pin low dropout linear regulator. The superior characteristics of the AIC1735 include zero base current loss, very low dropout voltage, and 2% accuracy output voltage. Typical ground current remains approximately 65 $\mu$ A, for loading ranging from zero to maximum. Dropout voltage turns substantially low when output current is 100mA. Built-in output current limiting and thermal limiting provide maximal protection to the AIC1735 against fault conditions.

The AIC1735 is available in popular SOT-23, SOT-223, SOT-89 and TO-252 packages.

## TYPICAL APPLICATION CIRCUIT

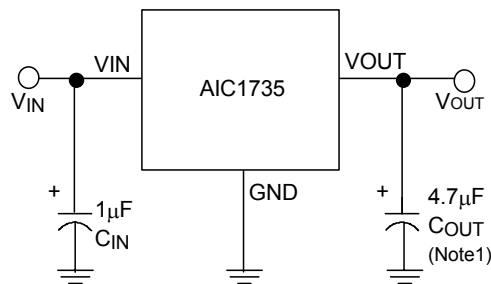

Low Dropout Linear Regulator

## ORDERING INFORMATION

AIC1735-XXXX XX

PACKING TYPE  
 TR: TAPE & REEL  
 TB: TUBE

PACKAGE TYPE  
 E: TO-252  
 U: SOT-23  
 X: SOT-89  
 Y: SOT-223

C: Commercial  
 P: Lead Free Commercial  
 G: Green Package

**OUTPUT VOLTAGE**

18: 1.8V  
 20: 2.0V  
 25: 2.5V  
 27: 2.7V  
 30: 3.0V  
 33: 3.3V  
 35: 3.5V  
 37: 3.7V  
 38: 3.8V  
 50: 5.0V  
 52: 5.2V

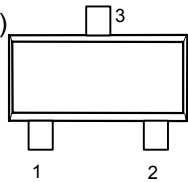
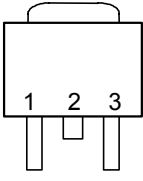
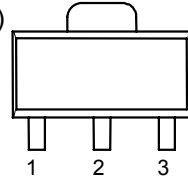
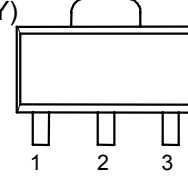
PIN CONFIGURATION	
SOT-23 (CU & PU) TOP VIEW 1: GND 2: VOUT 3: VIN	
TO-252 (CE & PE) TOP VIEW 1: VOUT 2: GND 3: VIN	
SOT-89 (CX & PX) TOP VIEW 1: GND 2: VIN 3: VOUT	
SOT-223 (CY & PY) TOP VIEW 1: VOUT 2: GND 3: VIN	

Example: AIC1735-18CETR

→ 1.8V Version, in TO-252 Package & Tape & Reel Packing Type

AIC1735-18PYTR

→ 1.8V Version, in Lead Free SOT-223 Package & Tape & Reel Packing Type

AIC1735-18GYTR

→ 1.8V Version, in Green SOT-223 Package & Tape & Reel Packing Type

**● SOT-23 MARKING**

Part No.	CU	PU	GU	Part No.	CU	PU	GU
AIC1735-18XU	CE18	CE18P	CE18G	AIC1735-35XU	CE35	CE35P	CE35G
AIC1735-20XU	CE20	CE20P	CE20G	AIC1735-37XU	CE37	CE37P	CE37G
AIC1735-25XU	CE25	CE25P	CE25G	AIC1735-38XU	CE38	CE38P	CE38G
AIC1735-27XU	CE27	CE27P	CE27G	AIC1735-50XU	CE50	CE50P	CE50G
AIC1735-30XU	CE30	CE30P	CE30G	AIC1735-52XU	CE52	CE52P	CE52G
AIC1735-33XU	CE33	CE33P	CE33G				

**● SOT-89 MARKING**

Part No.	CX	PX	GX	Part No.	CX	PX	GX
AIC1735-18XX	CF18	CF18P	CF18G	AIC1735-35XX	CF35	CF35P	CF35G
AIC1735-20XX	CF20	CF20P	CF20G	AIC1735-37XX	CF37	CF37P	CF37G
AIC1735-25XX	CF25	CF25P	CF25G	AIC1735-38XX	CF38	CF38P	CF38G
AIC1735-27XX	CF27	CF27P	CF27G	AIC1735-50XX	CF50	CF50P	CF50G
AIC1735-30XX	CF30	CF30P	CF30G	AIC1735-52XX	CF52	CF52P	CF52G
AIC1735-33XX	CF33	CF33P	CF33G				

**● SOT-223 MARKING**

Part No.	CY	PY	GY	Part No.	CY	PY	GY
AIC1735-18XY	CC18	CC18P	CC18G	AIC1735-35XY	CC35	CC35P	CC35G
AIC1735-20XY	CC20	CC20P	CC20G	AIC1735-37XY	CC37	CC37P	CC37G
AIC1735-25XY	CC25	CC25P	CC25G	AIC1735-38XY	CC38	CC38P	CC38G
AIC1735-27XY	CC27	CC27P	CC27G	AIC1735-50XY	CC50	CC50P	CC50G
AIC1735-30XY	CC30	CC30P	CC30G	AIC1735-52XY	CC52	CC52P	CC52G
AIC1735-33XY	CC33	CC33P	CC33G				

**■ ABSOLUTE MAXIMUM RATINGS**

Input Supply Voltage	.....	-0.3~12V
Operating Temperature Range	.....	-40°C~ 85°C
Maximum Junction Temperature	.....	150°C
Storage Temperature Range	.....	-65°C~150°C
Lead Temperature (Soldering) 10 sec.	.....	260°C
Thermal Resistance Junction to Case	SOT-23 Package	.....130°C/W
	TO-252 Package	.....12.5°C/W
	SOT-89 Package	.....100°C/W
	SOT-223 Package	.....15°C/W
Thermal Resistance Junction to Ambient	SOT-23 Package	.....180°C/W
(Assume no Ambient Airflow, no Heatsink)	TO-252 Package	.....100°C/W
	SOT-89 Package	.....160°C/W
	SOT-223 Package	.....130°C/W

**Absolute Maximum Ratings are those values beyond which the life of a device may be impaired.**

**■ TEST CIRCUIT**

Refer to the TYPICAL APPLICATION CIRCUIT

**ELECTRICAL CHARACTERISTICS** ( $T_A=25^{\circ}\text{C}$ ,  $C_{IN}=1\mu\text{F}$ ,  $C_{OUT}=4.7\mu\text{F}$ , unless otherwise specified.) (Note2)

PARAMETER	TEST CONDITIONS	MIN.	TYP.	MAX.	UNIT	
Output Voltage	No Load					
	AIC1735-52	$V_{IN}=5.5\sim 12\text{V}$	5.100	5.200	5.300	V
	AIC1735-50	$V_{IN}=5.5\sim 12\text{V}$	4.900	5.000	5.100	
	AIC1735-38	$V_{IN}=4.7\sim 12\text{V}$	3.725	3.800	3.875	
	AIC1735-37	$V_{IN}=4.7\sim 12\text{V}$	3.625	3.700	3.775	
	AIC1735-35	$V_{IN}=4.7\sim 12\text{V}$	3.430	3.500	3.570	
	AIC1735-33	$V_{IN}=4.7\sim 12\text{V}$	3.235	3.300	3.365	
	AIC1735-30	$V_{IN}=4.0\sim 12\text{V}$	2.940	3.000	3.060	
	AIC1735-27	$V_{IN}=4.0\sim 12\text{V}$	2.646	2.700	2.754	
	AIC1735-25	$V_{IN}=4.0\sim 12\text{V}$	2.450	2.500	2.550	
AIC1735-20	$V_{IN}=4.0\sim 12\text{V}$	1.960	2.000	2.040		
AIC1735-18	$V_{IN}=4.0\sim 12\text{V}$	1.764	1.800	1.836		
Output Voltage Temperature Coefficiency	(Note 3)		50		PPM/ $^{\circ}\text{C}$	
Line Regulation	$I_L=1\text{mA}$ , $1.4\text{V}\leq V_{OUT}\leq 3.2\text{V}$	$V_{IN}=4\text{V}\sim 12\text{V}$	3	10	mV	
	$3.3\text{V}\leq V_{OUT}\leq 5.2\text{V}$	$V_{IN}=5.5\text{V}\sim 12\text{V}$	3	10		
Load Regulation (Note 4)	$I_L=0.1\sim 500\text{mA}$ $1.4\text{V}\leq V_{OUT}\leq 3.9\text{V}$	$V_{IN}=5\text{V}$	10	30	mV	
	$4.0\text{V}\leq V_{OUT}\leq 5.2\text{V}$	$V_{IN}=7\text{V}$	20	50		
Current Limit (Note 5)	$V_{IN}=7\text{V}$ , $V_{OUT}=0\text{V}$	500			mA	
Dropout Voltage (Note 6)	$I_L=500\text{mA}$	$4.0\text{V}\leq V_{OUT}\leq 5.2\text{V}$	510	710	mV	
		$3.0\text{V}\leq V_{OUT}\leq 3.9\text{V}$	650	850		
		$2.5\text{V}\leq V_{OUT}\leq 2.9\text{V}$	780	980		
		$2.0\text{V}\leq V_{OUT}\leq 2.4\text{V}$	1100	1300		
		$1.4\text{V}\leq V_{OUT}\leq 1.9\text{V}$	1400	1600		
Ground Current	$I_O=0.1\text{mA}\sim I_{MAX}$ $1.4\text{V}\leq V_{OUT}\leq 3.9\text{V}$	$V_{IN}=5\sim 12\text{V}$	65	90	$\mu\text{A}$	
	$4.0\text{V}\leq V_{OUT}\leq 5.2\text{V}$	$V_{IN}=7\sim 12\text{V}$	65	90		

Note 1: To avoid output oscillation, aluminum electrolytic output capacitor is recommended and ceramic capacitor is not suggested.

Note 2: Specifications are production tested at  $T_A=25^{\circ}\text{C}$ . Specifications over the  $-40^{\circ}\text{C}$  to  $85^{\circ}\text{C}$  operating temperature range are assured by design, characterization and correlation with Statistical Quality Controls (SQC).

Note 3: Guaranteed by design.

Note 4: Regulation is measured at constant junction temperature, using pulse testing with a low ON time.

Note 5: Current limit is measured by pulsing a short time.

Note 6: Dropout voltage is defined as the input to output differential at which the output voltage drops 100mV below the value measured with a 1V differential.

**TYPICAL PERFORMANCE CHARACTERISTICS**

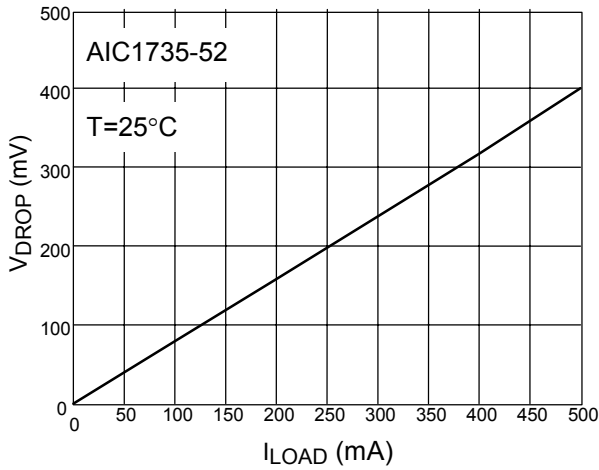

Fig. 1 V<sub>DR</sub>OP vs. I<sub>LOAD</sub>

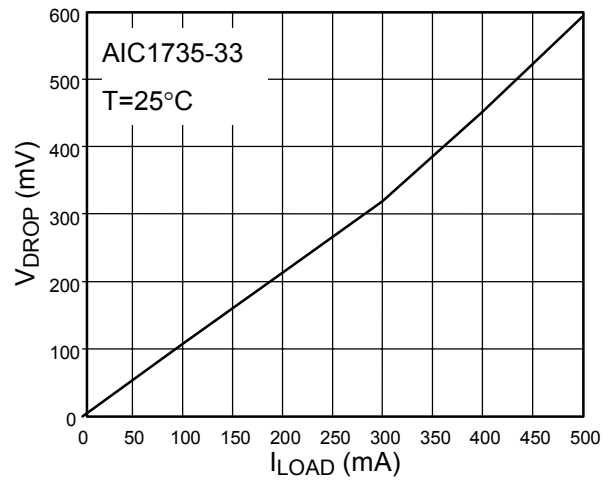

Fig. 2 V<sub>DR</sub>OP vs. I<sub>LOAD</sub>

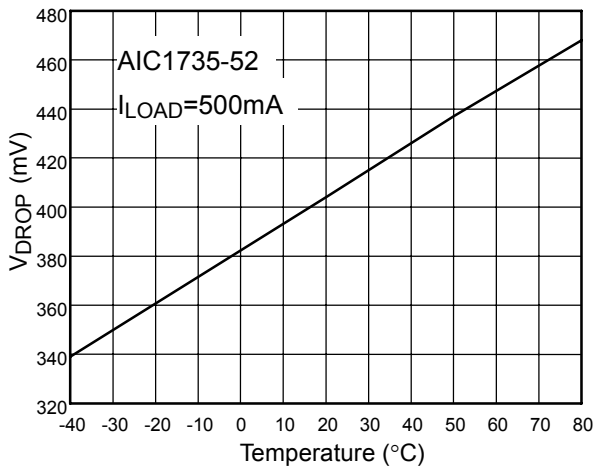

Fig. 3 V<sub>DR</sub>OP vs. Temperature

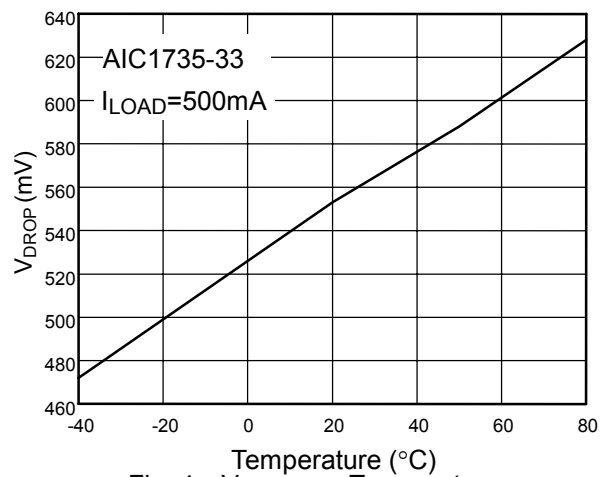

Fig. 4 V<sub>DR</sub>OP vs. Temperature

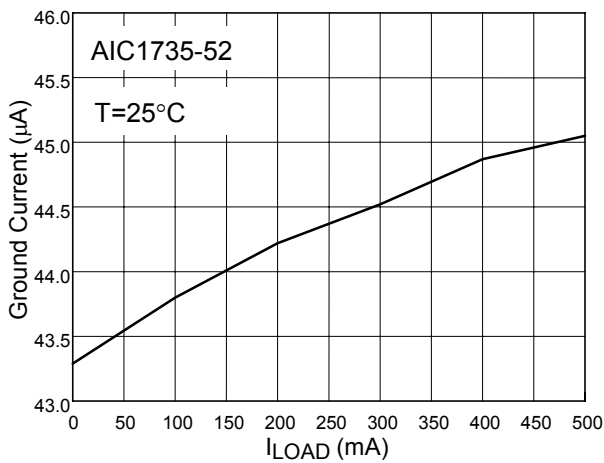

Fig. 5 Ground Current vs. I<sub>LOAD</sub>

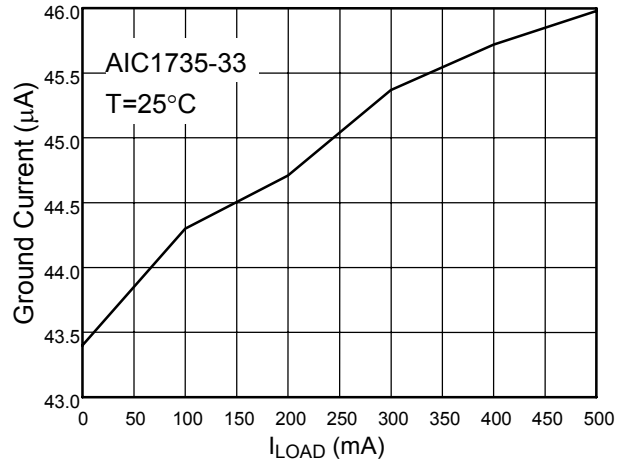

Fig. 6 Ground Current vs. I<sub>LOAD</sub>

**TYPICAL PERFORMANCE CHARACTERISTICS (Continued)**

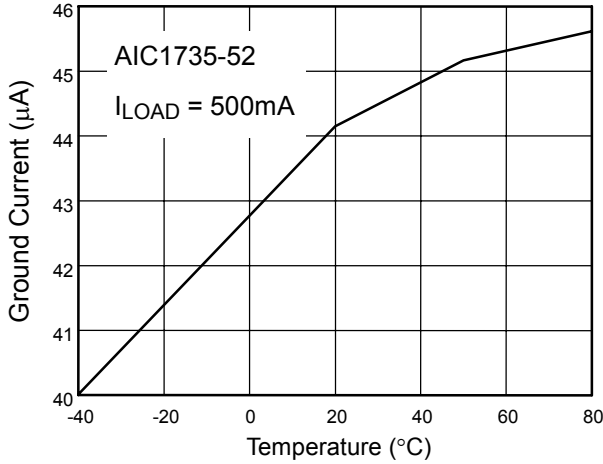

Fig. 7 Ground Current vs. Temperature

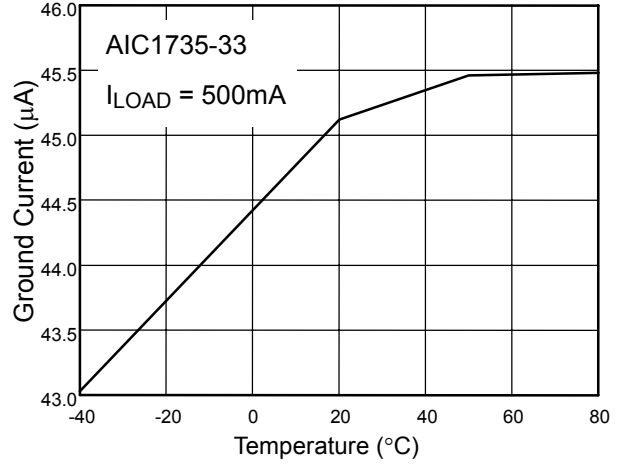

Fig. 8 Ground Current vs. Temperature

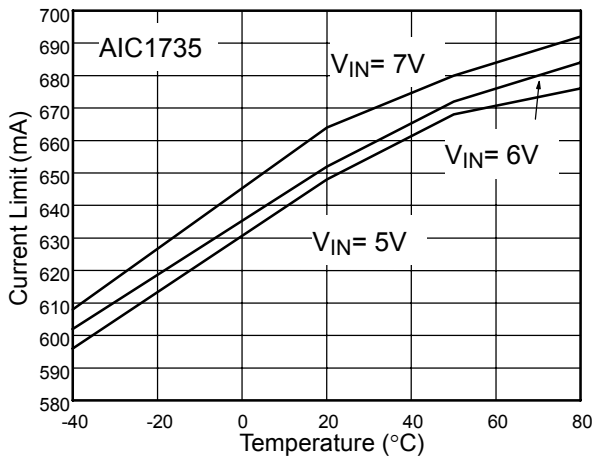

Fig. 9 Current Limit vs. Temperature

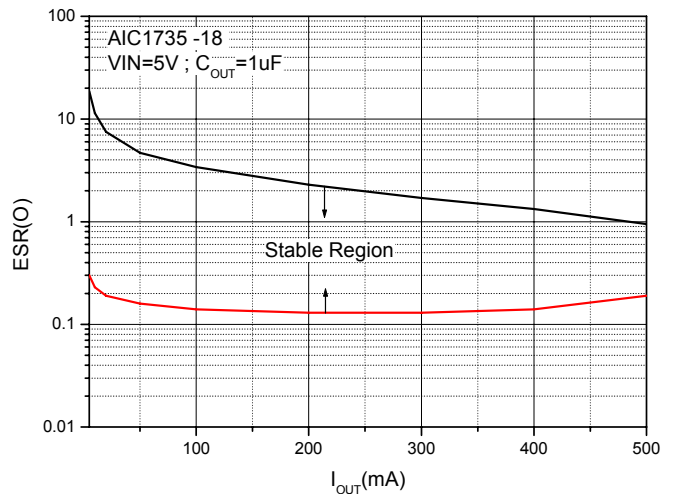

Fig. 10 Region of Stable COUT ESR vs. Load Current

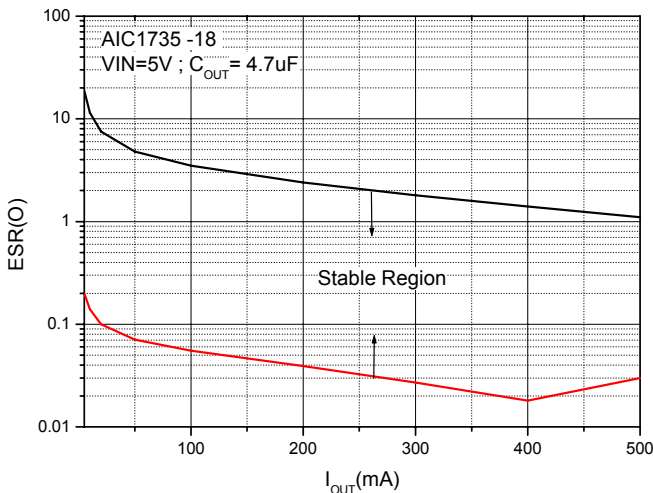

Fig. 11 Region of Stable COUT ESR vs. Load Current

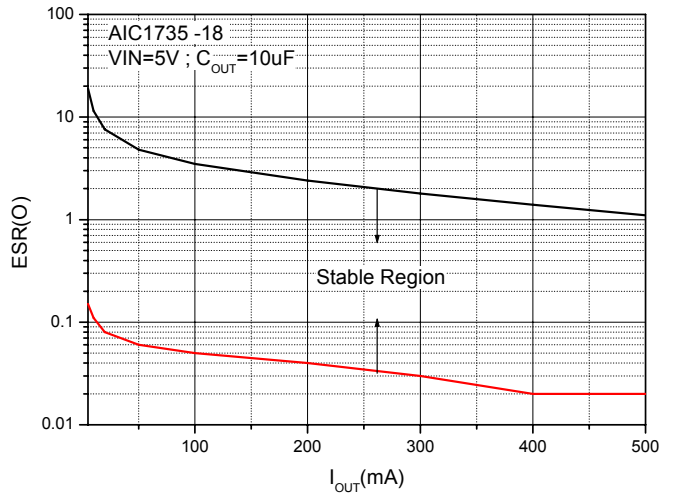
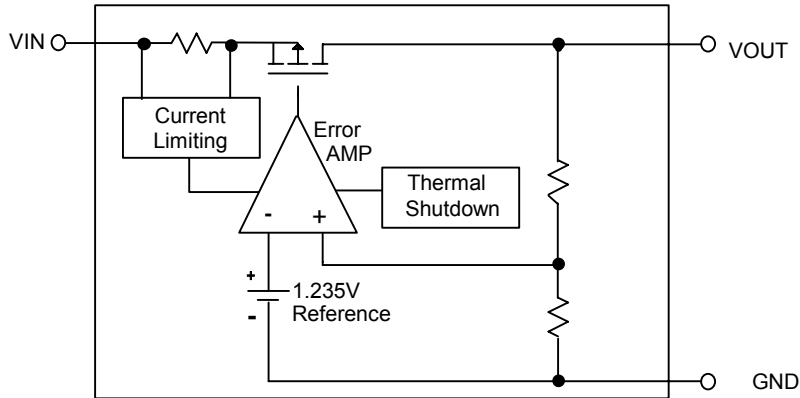

Fig. 12 Region of Stable COUT ESR vs. Load Current

## ■ BLOCK DIAGRAM



## ■ PIN DESCRIPTIONS

VOUT PIN - Output pin.

GND PIN - Power GND.

VIN PIN - Power Supply Input.

## ■ APPLICATION INFORMATION

### INPUT-OUTPUT CAPACITORS

Linear regulators require input and output capacitors to maintain stability. A 1uF aluminum electrolytic input capacitor with a 4.7uF aluminum electrolytic output capacitor is recommended. To avoid oscillation, it is recommended to follow the figures of "Region of Stable  $C_{OUT}$  ESR vs. Load Current" to choose proper capacitor specifications.

### POWER DISSIPATION

The AIC1735 obtains thermal-limiting circuitry, which is designed to protect the device against overload condition. For continuous load condition, maximum rating of junction temperature must not be exceeded. It is important to pay more attention in thermal resistance. It includes junction to case, junction to ambient. The maximum power dissipation of

AIC1735 depends on the thermal resistance of its case and circuit board, the temperature difference between the die junction and ambient air, and the rate of airflow. The rate of temperature rise is greatly affected by the mounting pad configuration on the PCB, the board material, and the ambient temperature. When the IC mounting with good thermal conductivity is used, the junction temperature will be low even when large power dissipation applies.

The power dissipation across the device is

$$P = I_{OUT} (V_{IN} - V_{OUT}).$$

The maximum power dissipation is:

$$P_{MAX} = \frac{(T_{J-max} - T_A)}{R\theta_{JA}}$$

Where  $T_{J-max}$  is the maximum allowable junction temperature (125°C), and  $T_A$  is the ambient



temperature suitable in application. As a general rule, the lower temperature is, the better reliability of the device is. So the PCB mounting pad should provide maximum thermal conductivity to maintain low device temperature. GND pin performs a dual function for providing

an electrical connection to ground and channeling heat away. Therefore, connecting the GND pin to ground with a large pad or ground plane would increase the power dissipation and reduce the device temperature.

## ■ PHYSICAL DIMENSIONS (unit: mm)

### ● SOT-23

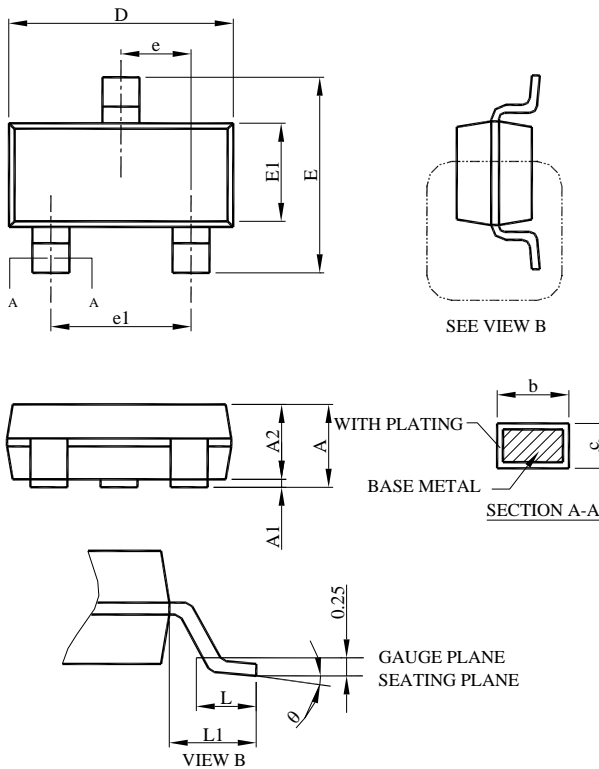

SYMBOL	SOT-23	
	MILLIMETERS	
	MIN.	MAX.
A	0.95	1.45
A1	0.05	0.15
A2	0.90	1.30
b	0.30	0.50
c	0.08	0.22
D	2.80	3.00
E	2.60	3.00
E1	1.50	1.70
e	0.95 BSC	
e1	1.90 BSC	
L	0.30	0.60
L1	0.60 REF	
θ	0°	8°

- Note:
- 1.Refer to JEDEC MO-178.
  - 2.Dimension D and E1 do not include mold flash, protrusions or gate burrs. Mold flash, protrusion or gate burrs shall not exceed 10 mil per side.
  - 3.Controlling dimension is millimeter, converted inch dimensions are not necessarily exact.

● TO-252

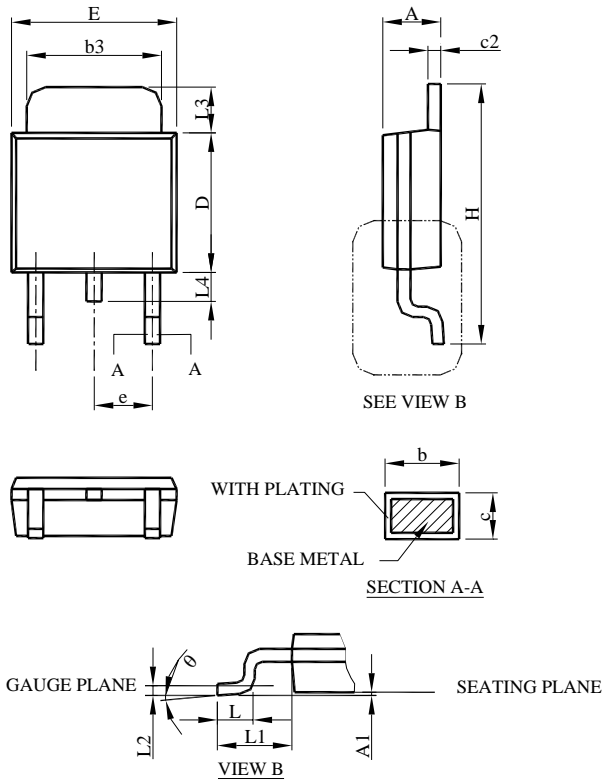

SYMBOL	TO-252-3L	
	MILLIMETERS	
	MIN.	MAX.
A	2.19	2.38
A1	0.00	0.13
b	0.64	0.89
b3	4.95	5.46
c	0.46	0.61
c2	0.46	0.89
D	5.33	6.22
E	6.35	6.73
e	2.28 BSC	
H	9.40	10.41
L	1.40	1.78
L1	2.67 REF	
L2	0.51 BSC	
L3	0.89	2.03
L4	--	1.02
θ	0°	8°

Note:

- 1.Refer to JEDEC TO-252AA and AB.
- 2.Dimension D and E do not include mold flash, protrusions or gate burrs. Mold flash, protrusion or gate burrs shall not exceed 6 mil per side.
- 3.Controlling dimension is millimeter, converted inch dimensions are not necessarily exact.

● SOT-89

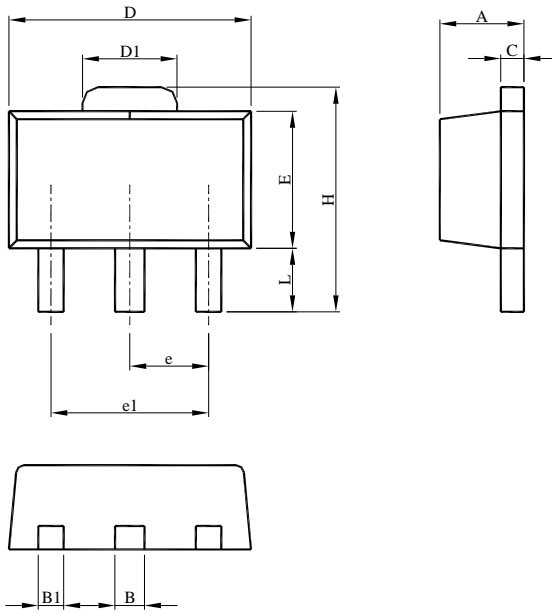

SOT-89		
MILLIMETERS		
SYMBOL	MIN.	MAX.
A	1.40	1.60
B	0.44	0.56
B1	0.36	0.48
C	0.35	0.44
D	4.40	4.60
D1	1.50	1.83
E	2.29	2.60
e	1.50 BSC	
e1	3.00 BSC	
H	3.94	4.25
L	0.89	1.20

Note:  
 1.Refer to JEDEC TO-243AA.  
 2.Controlling dimension is millimeter, converted inch dimensions are not necessarily exact.

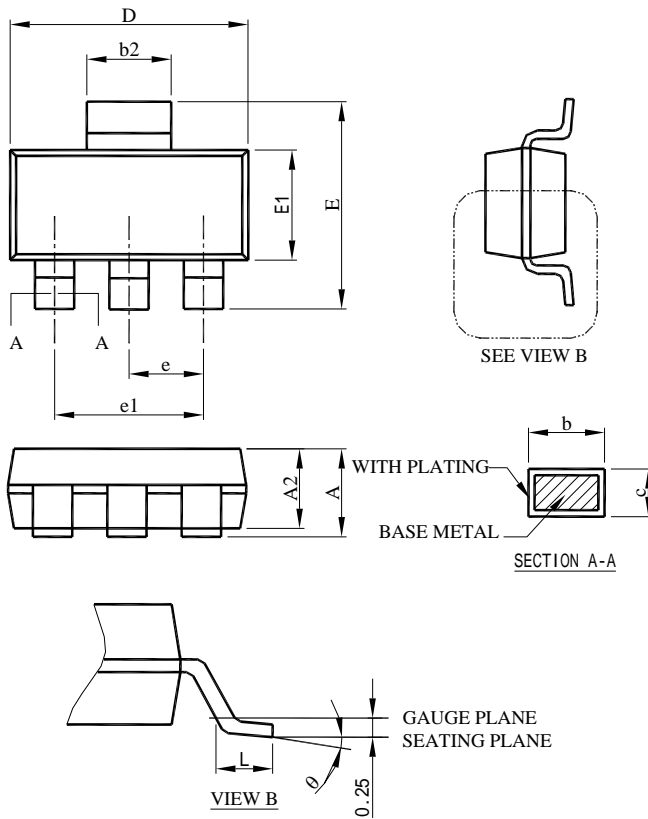
**● SOT-223**

SYMBOL	SOT-223	
	MILLIMETERS	
	MIN.	MAX.
A		1.80
A1	0.02	0.10
A2	1.55	1.65
b	0.66	0.84
b2	2.90	3.10
c	0.23	0.33
D	6.30	6.70
E	6.70	7.30
E1	3.30	3.70
e	2.30 BSC	
e1	4.60 BSC	
L	0.90	
$\theta$	0°	8°

**Note:**

1. Refer to JEDEC TO-261AA.
2. Dimension D and E1 are determined at the outermost extremes of the plastic body exclusive of mold flash, tie bar burrs, gate burrs, and interlead flash, but including any mismatch between the top and bottom of the plastic body.
3. Controlling dimension is millimeter, converted inch dimensions are not necessarily exact.

**Note:**

Information provided by AIC is believed to be accurate and reliable. However, we cannot assume responsibility for use of any circuitry other than circuitry entirely embodied in an AIC product; nor for any infringement of patents or other rights of third parties that may result from its use. We reserve the right to change the circuitry and specifications without notice.

Life Support Policy: AIC does not authorize any AIC product for use in life support devices and/or systems. Life support devices or systems are devices or systems which, (i) are intended for surgical implant into the body or (ii) support or sustain life, and whose failure to perform, when properly used in accordance with instructions for use provided in the labeling, can be reasonably expected to result in a significant injury to the user.