

AVX is a leading worldwide manufacturer and supplier of a broad line of passive electronic components and Interconnects.

AVX enjoys significant competitive advantages including the benefit of having research, manufacturing, and customer support facilities in 15 countries around the world. This assures customers of the most efficient balance of delivery and production capability in response to their just-in-time inventory requirements. With major research and development centers in five locations around the world, AVX has fostered customer relationships involving the design and technology for new and advanced products to fulfill their special end product requirements.

AVX research and development has anticipated and adapted products that help fuel the explosive growth in communications technology.

Tantalum Capacitors/ Niobium Oxide Capacitors Series Guide

Resin-Molded									
Standard									
General (Standard)		Low Profile		Low ESR			Face-Down		
F93	TAJ	F92	TAJ	F91	TPS	TPM	F98	F98-AS1	
Small Case	High Voltage	Small Case	High Voltage	Small Case	High Voltage	Multi anode	Small Case High Capacitance	Fused	
High Reliability									
General (High Reliability)		Small Case High Capacitance		Low ESR		High Temperature			
F97	TRJ	F93-AJ6		F91-AJ6	TRM	F97-HT3	THJ		
Small Case	High Voltage			Small Case High Capacitance	Multi anode	Small Case	High Voltage		
Conductive Polymer									
Ultra Small Case High Capacitance		Small Case High Capacitance		High Voltage		Low ESR			
F38		TCN		TCJ		TCM			
Conformal Coated									
Small Case Low Profile			Low Profile			High Capacitance			
F95-AM1 (AUDIO) F95			F72			F75			
Niobium Oxide Capacitors OxiCap®									
General		Low ESR		Multianode					
NOJ		NOS		NOM					
								TAP	
								Leaded	

* Option

Tantalum Capacitors Product Line-up

Series	Resin-Molded (Standard)				
	F93	TAJ	F92	TAJ (Low Profile)	F91
Features	<ul style="list-style-type: none"> •General •Small Case 	<ul style="list-style-type: none"> •General •High Voltage 	<ul style="list-style-type: none"> •Low Profile •Small Case 	<ul style="list-style-type: none"> •Low Profile •High Voltage 	<ul style="list-style-type: none"> •Low ESR •Small Case
Appearance					
Type	Resin-Molded Chip	Resin-Molded Chip	Resin-Molded Chip	Resin-Molded Chip	Resin-Molded Chip
Operating Temperature Range (°C)	-55 to +125	-55 to +125	-55 to +125	-55 to +125	-55 to +125
Voltage Range (V)	4 to 35	2.5 to 50	4 to 35	2.5 to 50	4 to 35
Capacitance (µF)	0.68 to 680	0.1 to 2200	0.22 to 150	0.1 to 1000	6.8 to 680
Tolerance (%)	±20, ±10	±20, ±10	±20	±20, ±10	±20, ±10
Leakage Current (µA)	0.01CV or 0.5 max.	0.5 to 60	0.01CV to 0.1CV or 0.5 max.	0.5 to 28.2	0.01CV or 0.5 max.
Dissipation Factor (%)	4 to 40 max.	4 to 60 max.	4 to 30 max.	4 to 30 max.	6 to 18 max.
Failure Rate Level	at 85°C Rated Voltage Applied 1% / 1000 hours	at 85°C Rated Voltage Applied 1% / 1000 hours	at 85°C Rated Voltage Applied 1% / 1000 hours	at 85°C Rated Voltage Applied 1% / 1000 hours	at 85°C Rated Voltage Applied 1% / 1000 hours
Typical applications*	Consumer products, Industrial equipments				

Series	Resin-Molded (Standard)		Resin-Molded (High Reliability)		
	TPS/ TPM	F98/ F98-AS1	F97	TRJ	F93-AJ6
Features	<ul style="list-style-type: none"> •Low ESR •High Voltage •Multinode (TPM) 	<ul style="list-style-type: none"> •Face-Down Terminal •Small Case •High Capacitance •Fused type (F98-AS1) 	<ul style="list-style-type: none"> •General •Small Case 	<ul style="list-style-type: none"> •General •High Voltage 	<ul style="list-style-type: none"> •Small Case •High Capacitance
Appearance					
Type	Resin-Molded Chip	Resin-Molded Chip	Resin-Molded Chip	Resin-Molded Chip	Resin-Molded Chip
Operating Temperature Range (°C)	-55 to +125	-55 to +125	-55 to +125	-55 to +125	-55 to +125
Voltage Range (V)	2.5 to 50	2.5 to 35 (F98) 10 to 35 (F98-AS1)	6.3 to 35	6.3 to 50	4 to 35
Capacitance (µF)	0.15 to 2200	1 to 220 (F98) 1 to 47 (F98-AS1)	0.33 to 150	0.1 to 680	1 to 680
Tolerance (%)	±20, ±10	±20	±20, ±10	±20, ±10	±20, ±10
Leakage Current (µA)	0.5 to 63	0.01CV to 0.2CV or 0.5 max.	0.01CV or 0.5 max.	0.3 to 39	0.01CV or 0.5 max.
Dissipation Factor (%)	4 to 60 max.	6 to 80 max. (F98) 18 to 30 max. (F98-AS1)	4 to 15 max.	4 to 30 max.	4 to 30 max.
Failure Rate Level	at 85°C Rated Voltage Applied 1% / 1000 hours	at 85°C Rated Voltage Applied 1% / 1000 hours	at 85°C Rated Voltage Applied 0.5% / 1000 hours	at 85°C Rated Voltage Applied 0.5% / 1000 hours	at 85°C Rated Voltage Applied 1% / 1000 hours
Typical applications*	Consumer products, Industrial equipments		Automotive products, Industrial equipments		

Series	Resin-Molded (High Reliability)			
	F91-AJ6	TRM	F97-HT3	THJ
Features	<ul style="list-style-type: none"> •Low ESR •Small Case •High Capacitance 	<ul style="list-style-type: none"> •Low ESR •Multinode 	<ul style="list-style-type: none"> •Temperature 135°C •Small Case •High Capacitance 	<ul style="list-style-type: none"> •Temperature 175°C, 200°C •High Voltage
Appearance				
Type	Resin-Molded Chip	Resin-Molded Chip	Resin-Molded Chip	Resin-Molded Chip
Operating Temperature Range (°C)	-55 to +125	-55 to +125	-55 to +135	-55 to +175, +200
Voltage Range (V)	6.3 to 16	2.5 to 50	6.3 to 35	6.3 to 50
Capacitance (µF)	10 to 47	4.7 to 1500	0.33 to 100	0.1 to 220
Tolerance (%)	±20, ±10	±20, ±10	±20, ±10	±20, ±10
Leakage Current (µA)	0.01CV or 0.5 max.	1.8 to 30	0.01CV or 0.5 max.	0.5 to 22
Dissipation Factor (%)	6 to 12 max.	6 to 8 max.	4 to 15 max.	3 to 10 max.
Failure Rate Level	at 85°C Rated Voltage Applied 1% / 1000 hours	at 85°C Rated Voltage Applied 0.5% / 1000 hours	at 95°C Rated Voltage Applied 0.5% / 1000 hours	at 85°C Rated Voltage Applied 0.5% / 1000 hours
Typical applications*	Automotive products, Industrial equipments			

* This table is not intended to limit the applications. Please see each page of products for detailed specifications.

Tantalum Capacitors Product Line-up

Series	Conductive Polymer			
	F38	TCN	TCJ	TCM
Features	<ul style="list-style-type: none"> •Ultra Small case •High Capacitance •Face-Down Terminal •Low ESR •High Ripple 	<ul style="list-style-type: none"> •Small case •High Capacitance •Face-Down Terminal •Low ESR •High Ripple 	<ul style="list-style-type: none"> •High Voltage •Low ESR •High Ripple 	<ul style="list-style-type: none"> •Ultra Low ESR •High Ripple •Multianode
Appearance				
Type	Conductive Polymer Resin Molded Chip	Conductive Polymer Resin Molded Chip	Conductive Polymer Resin Molded Chip	Conductive Polymer Resin Molded Chip
Operating Temperature Range (°C)	-55 to +105	-55 to +105	-55 to +85, +105, +125	-55 to +105
Voltage Range (V)	4 to 10	6.3 to 35	2.5 to 125	4 to 100
Capacitance (µF)	2.2 to 100	4.7 to 1000	0.47 to 470	10 to 1000
Tolerance (%)	±20	±20	±20	±20
Leakage Current (µA)	0.2CV or 10 max.	35 to 600	2.5 to 282	77 to 408
Dissipation Factor (%)	6 to 15 max	6 to 30 max.	6 to 12 max.	8 max.
Failure Rate Level	at 85°C Rated Voltage Applied 1% / 1000 hours	at 85°C Rated Voltage Applied 1% / 1000 hours	at 85°C Rated Voltage Applied 1% / 1000 hours	at 85°C Rated Voltage Applied 1% / 1000 hours
Typical applications*	Consumer products, Industrial equipments			

Series	Conformal Coated		
	F95-AM1/ F95	F72	F75
Features	<ul style="list-style-type: none"> •For Audio Equipment (F95-AM1) •Small Rectangular •Low ESR/ impedance, Excellent High Frequency Characteristics 	<ul style="list-style-type: none"> •Low Profile •High Capacitance •Low ESR/ impedance, Excellent High Frequency Characteristics 	<ul style="list-style-type: none"> •High Capacitance •Low ESR/ impedance, Excellent High Frequency Characteristics
Appearance			
Type	Coformal Coated Chip	Coformal Coated Chip	Coformal Coated Chip
Operating Temperature Range (°C)	-55 to +125	-55 to +125	-55 to +125
Voltage Range (V)	4 to 10 (F95-AM1) / 4 to 35 (F95)	4 to 16	4 to 16
Capacitance (µF)	68 to 470 (F95-AM1) / 1 to 470 (F95)	33 to 1500	68 to 2200
Tolerance (%)	±20, ±10	±20, ±10	±20, ±10
Leakage Current (µA)	0.01CV to 0.02CV or 0.5 max.	0.01CV to 0.02CV or 0.5 max.	0.01CV to 0.02CV or 0.5 max.
Dissipation Factor (%)	10 to 40 max. (F95-AM1) / 4 to 40 max (F95)	6 to 45 max.	10 to 45 max.
Failure Rate Level	at 85°C Rated Voltage Applied 1% / 1000 hours	at 85°C Rated Voltage Applied 1% / 1000 hours	at 85°C Rated Voltage Applied 1% / 1000 hours
Typical applications*	Consumer products, Industrial equipments		

Niobium Oxide Capacitors OxiCap® Product Line-up

Series	Niobium Oxide Capacitors OxiCap®	
	NOJ	NOS/ NOM
Features	<ul style="list-style-type: none"> •Non burn safe technology •General 	<ul style="list-style-type: none"> •Non burn safe technology •Low ESR •Multianode (NOM)
Appearance		
Type	Resin-Molded Chip	Resin-Molded Chip
Operating Temperature Range (°C)	-55 to +105	-55 to +125
Voltage Range (V)	1.8 to 10	1.8 to 8
Capacitance (µF)	4.7 to 1000	10 to 1000
Tolerance (%)	±20	±20
Leakage Current (µA)	1.1 to 80	1.1 to 56.4
Dissipation Factor (%)	6 to 20 max.	6 to 16 max.
Failure Rate Level	at 85°C Rated Voltage Applied 0.5% / 1000 hours	at 85°C Rated Voltage Applied 0.2% / 1000 hours
Typical applications*	Automotive products, Industrial equipments, Consumer products	

Compliance with RoHS Directive

Compliance with RoHS Directive	Compliant
Leaded (Pb)	Does not contain
Chromium(VI)	
Mercury	
Cadmium	
PBB	
PBDE	* LEVEL 1 to LEVEL 3
MSL (IPC/ JEDC J-STD-020)	

* If you need detailed information about MSL LEVEL, please contact us.

* This table is not intended to limit the applications. Please see each page of products for detailed specifications.

Tantalum Capacitors Resin-molded Chip, Low Profile F92 Series

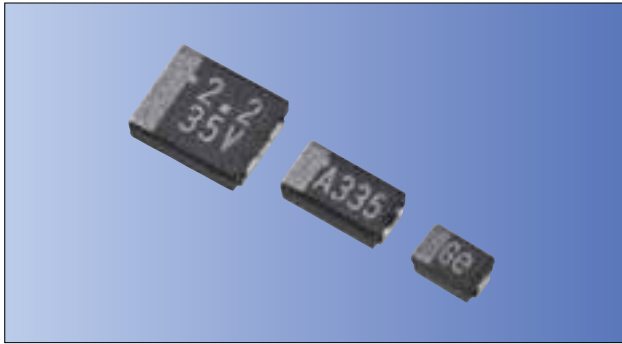

RoHS Compliant

Marking

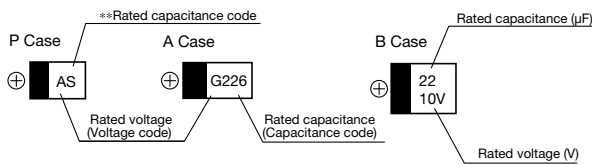

4V	G	10V	A	20V	D	35V	V
6.3V	J	16V	C	25V	E		

** Capacitance code of "P" case products are as shown below.

Specifications

Item	Performance Characteristics	
	P Case	A/ B Case
Category	-55 to +125°C (Rated temperature : +85°C or +60°C)	
Temperature Range	±20% (at 120Hz)	
Tolerance	Refer to Next Page (120Hz)	
Dissipation Factor	Refer to Next Page (100kHz)	
ESR	<ul style="list-style-type: none"> After 1 minute application of rated voltage, leakage current at 20°C is not more than 0.01CV or 0.5µA, whichever is greater. After 1 minute application of rated voltage, leakage current at 85°C (or 60°C) is not more than 0.1CV or 5µA, whichever is greater. After 1 minute application of derated voltage, leakage current at 125°C is not more than 0.125CV or 6.3µA, whichever is greater. 	
Leakage Current*	+20% max. (at +125°C) +15% max. (at +85°C) -15% max. (at -55°C)	+15% max. (at +125°C) +10% max. (at +85°C or +60°C) -10% max. (at -55°C)
Capacitance Change by Temperature	At 40°C 90 to 95% RH 500 hours (No voltage applied)	
Damp Heat (Steady State)	Capacitance Change... Refer to next page (*1) Dissipation Factor...150% or less than the initial specified value Leakage Current... Initial specified value or less	Refer to next page (*1) Initial specified value or less
Temperature Cycles	-55°C / +125°C 30 minutes each 5 cycles	
	Capacitance Change... Refer to next page (*1) Dissipation Factor...150% or less than the initial specified value Leakage Current... Initial specified value or less	Refer to next page (*1) Initial specified value or less

How to Order (Example : 6.3V 10µF)

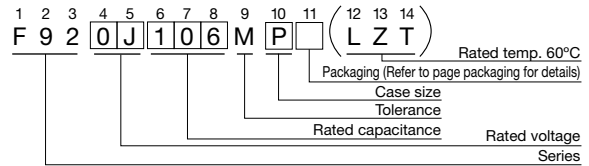

Case Dimensions

(Unit: mm)

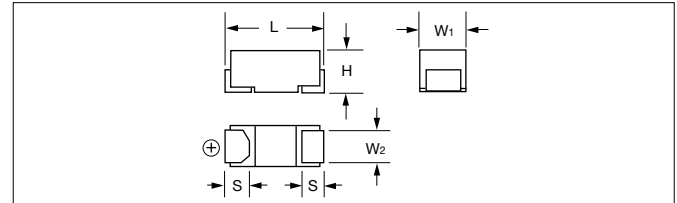

Case size	L	W ₁	W ₂	H	S
P	2.0±0.2	1.25±0.1	0.9±0.1	1.1±0.1	0.5±0.2
A	3.2±0.2	1.6±0.2	1.2±0.1	1.1±0.1	0.8±0.2
B	3.4±0.2	2.8±0.2	2.3±0.1	1.1±0.1	0.8±0.2

Item	Performance Characteristics	
	P Case	A/ B Case
Resistance to Soldering Heat	10 seconds reflow at 260°C, 5 seconds immersion at 260°C Capacitance Change... Refer to next page (*1) Dissipation Factor...150% or less than the initial specified value Leakage Current... Initial specified value or less	Refer to next page (*1) Initial specified value or less
Surge*	After application of surge voltage in series with a 33Ω (For "P" case : 1kΩ) resistor at the rate of 30 seconds ON, 30 seconds OFF (For "P" case : 5.5 minutes OFF), for 1000 successive test cycles at 85°C, capacitors shall meet the characteristic requirements table below. (except LZT type) Capacitance Change... Refer to next page (*1) Dissipation Factor...150% or less than the initial specified value Leakage Current... Initial specified value or less	Refer to next page (*1) Initial specified value or less
Endurance*	After 2000 hours application of rated voltage in series with a 3Ω resistor at 85°C (or 60°C), or derated voltage in series with a 3Ω resistor at 125°C, capacitors shall meet the characteristic requirements table below. Capacitance Change... Refer to next page (*1) Dissipation Factor...150% or less than the initial specified value Leakage Current... Initial specified value or less	Refer to next page (*1) Initial specified value or less
Shear Test	After applying the pressure load of 5N for 10±1 seconds horizontally to the center of capacitor side body which has no electrode and has been soldered beforehand on a substrate, there shall be found neither exfoliation nor its sign at the terminal electrode.	 5N (0.51kg·f) For 10 ± 1 seconds
Terminal Strength	Keeping a capacitor surface-mounted on a substrate upside down and supporting the substrate at both of the opposite bottom points 45mm apart from the center of capacitor, the pressure strength is applied with a specified jig at the center of substrate so that the substrate may bend by 1mm as illustrated. Then, there shall be found no remarkable abnormality on the capacitor terminals.	 R230 45 45 1mm

* As for the surge voltage and derated voltage at 125°C, refer to page precautions for details. In case of rated temperature 60°C type, test condition is 60°C.

Capacitance and Voltage Range

µF	CODE	V								** Capacitance code
		4	6.3	10	16	20	25	35		
0.22	224	0G	0J	1A	1C	1D	1E	1V	J	
0.33	334							A	N	
0.47	474				P	P/A		A	S	
0.68	684				P	A		A	W	
1	105			P	P	P/A	P/A	A	A	
1.5	155			P	P	A		A	E	
2.2	225		P	P	P/A	(P) / A		B	J	
3.3	335	P	P	P/A	A		A/B	B	N	
4.7	475	P	P	P/A	(P) / A/B	A/B	A/B		S	
6.8	685	P	P	P/A	B				W	
10	106	P/A	P/A	P/A	A/B	B			a	
15	156	P	P/A	A					e	
22	226	P/A	P/A	A/B	B				J	
33	336	P/A	A/B	B					n	
47	476	A/B	A/B						s	
68	686	A/B							-	
100	107	A/B	A/B						-	
150	157	B							-	
220	227	(B)							-	

() The series in parentheses are being developed. Please contact us when these series are being designed in your application.

Standard Ratings

Rated Voltage	Cap (μF)	Case size	Part Number	Leakage Current (μA)	Dissipation Factor (%@120Hz)	ESR (Ω@100kHz)	*1 ΔC/C (%)	
4V	3.3	P	F920G335MPA	0.5	8	12.0	*	
	4.7	P	F920G475MPA	0.5	8	6.0	*	
	6.8	P	F920G685MPA	0.5	10	6.0	*	
	10	P	F920G106MPA	0.5	10	6.0	*	
	10	A	F920G106MAA	0.5	8	4.0	*	
	15	P	F920G156MPA	0.6	10	5.0	*	
	22	P	F920G226MPA	0.9	20	5.0	*	
	22	A	F920G226MAA	0.9	12	2.8	*	
	33	P	F920G336MPA	1.3	20	4.0	*	
	33	A	F920G336MAA	1.3	12	2.8	*	
	47	A	F920G476MAA	1.9	18	2.8	*	
	47	B	F920G476MBA	1.9	12	1.7	*	
	68	A	F920G686MAA	2.7	25	2.8	±15	
	68	B	F920G686MBA	2.7	18	1.5	*	
	100	A	F920G107MAA	4.0	30	2.8	±15	
	100	B	F920G107MBA	4.0	18	1.3	*	
	150	B	F920G157MBA	6.0	25	1.3	±15	
	6.3V	2.2	P	F920J225MPA	0.5	8	12.0	*
3.3		P	F920J335MPA	0.5	8	12.0	*	
4.7		P	F920J475MPA	0.5	8	6.0	*	
6.8		P	F920J685MPA	0.5	10	6.0	*	
10		P	F920J106MPA	0.6	10	6.0	*	
10		A	F920J106MAA	0.6	8	4.0	*	
15		P	F920J156MPA	0.9	10	6.0	*	
15		A	F920J156MAA	0.9	8	4.0	*	
22		P	F920J226MPA	1.4	20	5.0	*	
22		A	F920J226MAA	1.4	12	2.8	*	
33		A	F920J336MAA	2.1	12	2.8	*	
33		B	F920J336MBA	2.1	12	1.7	*	
47		A	F920J476MAA	3.0	18	2.8	±15	
47		B	F920J476MBA	3.0	12	1.7	*	
100		A	F920J107MAALZT	63.0	40	3.0	±20	
100		B	F920J107MBA	6.3	20	1.3	±15	
10V		1	P	F921A105MPA	0.5	8	12.0	*
		1.5	P	F921A155MPA	0.5	8	12.0	*
	2.2	P	F921A225MPA	0.5	8	12.0	*	
	3.3	P	F921A335MPA	0.5	8	12.0	*	
	3.3	A	F921A335MAA	0.5	6	7.0	*	
	4.7	P	F921A475MPA	0.5	8	6.0	*	
	4.7	A	F921A475MAA	0.5	6	4.0	*	
	6.8	P	F921A685MPA	0.7	8	6.0	*	
	6.8	A	F921A685MAA	0.7	6	4.0	*	
	10	P	F921A106MPA	1.0	14	6.0	*	
	10	A	F921A106MAA	1.0	8	4.0	*	
	15	A	F921A156MAA	1.5	8	4.0	*	
	22	A	F921A226MAA	2.2	14	4.0	±15	
	22	B	F921A226MBA	2.2	8	1.9	*	
	33	B	F921A336MBA	3.3	12	1.9	*	
47	B	F921A476MBA	4.7	18	1.9	±15		
16V	0.47	P	F921C474MPA	0.5	8	20.0	*	
	0.68	P	F921C684MPA	0.5	8	12.0	*	
	1	P	F921C105MPA	0.5	8	12.0	*	
	1.5	P	F921C155MPA	0.5	8	12.0	*	
	2.2	P	F921C225MPA	0.5	8	12.0	*	
	2.2	A	F921C225MAA	0.5	6	7.0	*	
	3.3	A	F921C335MAA	0.5	6	7.0	*	
	4.7	A	F921C475MAA	0.8	6	7.0	*	
	4.7	B	F921C475MBA	0.8	6	3.0	*	
	6.8	B	F921C685MBA	1.1	6	3.0	*	
	10	A	F921C106MAA	1.6	8	7.0	±15	
	10	B	F921C106MBA	1.6	6	2.0	*	
22	B	F921C226MBA	3.5	12	2.0	±15		

Rated Voltage	Cap (μF)	Case size	Part Number	Leakage Current (μA)	Dissipation Factor (%@120Hz)	ESR (Ω@100kHz)	*1 ΔC/C (%)
20V	0.47	P	F921D474MPA	0.5	8	20.0	*
	0.47	A	F921D474MAA	0.5	4	10.0	*
	0.68	A	F921D684MAA	0.5	4	10.0	*
	1	P	F921D105MPA	0.5	8	20.0	*
	1	A	F921D105MAA	0.5	4	10.0	*
	1.5	A	F921D155MAA	0.5	6	7.4	*
	2.2	A	F921D225MAA	0.5	6	7.0	*
	4.7	A	F921D475MAA	0.9	10	7.0	±10
	4.7	B	F921D475MBA	0.9	6	3.0	*
	10	B	F921D106MBA	2.0	8	3.0	±10
25V	1	P	F921E105MPA	0.5	8	20.0	*
	1	A	F921E105MAA	0.5	6	10.0	*
	2.2	A	F921E225MAA	0.6	8	10.0	±15
	2.2	B	F921E225MBA	0.6	6	4.0	*
	4.7	A	F921E475MAA	1.2	10	7.0	±10
	4.7	B	F921E475MBA	1.2	6	3.0	*
35V	0.22	A	F921V224MAA	0.5	4	10.0	*
	0.33	A	F921V334MAA	0.5	4	10.0	*
	0.47	A	F921V474MAA	0.5	4	10.0	*
	1	A	F921V105MAA	0.5	6	10.0	*
	2.2	B	F921V225MBA	0.8	6	4.0	±10
	3.3	B	F921V335MBA	1.2	10	4.0	±10

* 1 : ΔC/C Marked ***

	P Case (%)	A/ B Case (%)
Damp Heat	±20	±10
Temperature cycles	±10	±5
Resistance soldering heat	±10	±5
Surge	±10	±5
Endurance	±10	±10

We can consider the type of compliance to AEC-Q200.
Please contact us when these series are being designed in your application.

Part Number

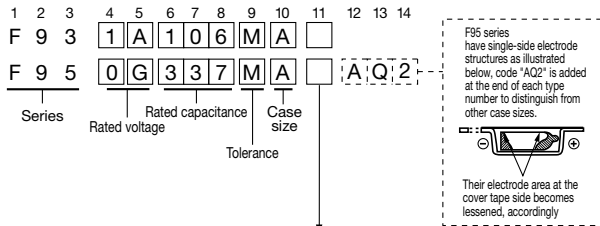

Tape Width (mm)	Polarity	Packaging		Applicable case size		
		Reel Dia. ϕ 180mm	Reel Dia. ϕ 330mm	F91/ F92/ F93/ F97/ F98/ F38	F95	F72/ F75
8	R Anode is at opposite side of feeding holes.	A	E	U/ M/ S/ P/ A/ B	R/ P/ Q/ S/ A/ T/ B	—
12	R Anode is at opposite side of feeding holes.	C	G	C/ N	—	U/ C/ D/ R/ M

Reel Dimensions

(Unit: mm)

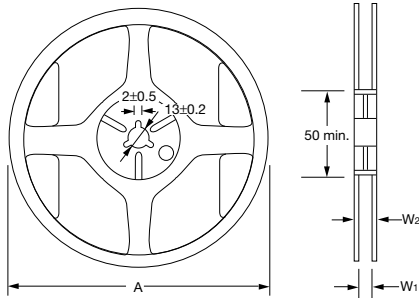

Note: The above shows the dimensions of ϕ 180 reel.
In case of ϕ 330 reel, the appearance shape is slightly different.

Item	Reel Diameter		Item	Tape width	
	ϕ 180	ϕ 330		8	12
A	ϕ 180 $^{+0.3}$	ϕ 330 \pm 2	W1	9.0 \pm 0.3	13 \pm 0.3
			W2	11.4 \pm 1.0	15.4 \pm 1.0

Taping

Series	Case size	Q'ty (pcs./ reel)	
		Reel Dia. ϕ 180	Reel Dia. ϕ 330
F38 F98	U	10000	—
	M	4000	—
	S	—	—
F92	P	3000	8000
	A/ B	2500	8000
F91 F93 F97	A	2000	8000
	B	2000	6000
F95	C/ N	500	2500
	R/ P	3000	10000
F72	Q/ S/ A/ T	2500	10000
	B	2000	8500
F75	R	1000	—
	M	500	—

Note: Series shall be replaced as necessary.

Series	Replaced	Series	Replaced
F91	F91 F91-AJ6	F97	F97 F97-HT3
F93	F93 F93-AJ6	F98	F98 F98-AS1
F95	F95 F95-AM1		

Carrier Tape Dimensions

(Unit: mm)

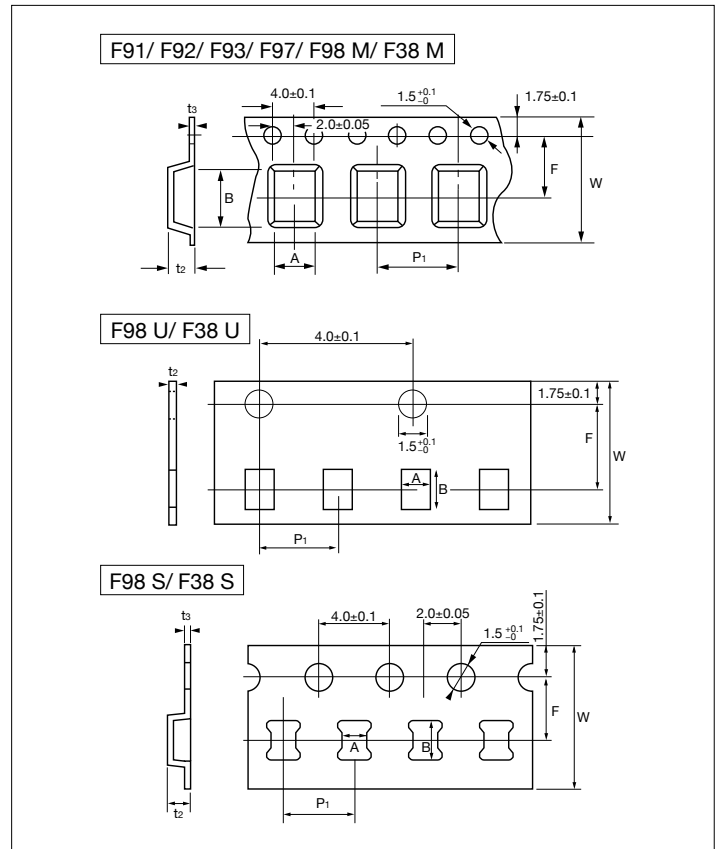

Case size	W	A	B	F	P1	t2	t3
U	8.0 \pm 0.3	0.73 \pm 0.08	1.20 \pm 0.05	3.5 \pm 0.05	2.0 \pm 0.1	0.7 max.	—
M		0.97 \pm 0.05	1.85 \pm 0.05	3.5 \pm 0.1	4.0 \pm 0.1	1.3 max.	0.20 \pm 0.05
S		1.35 \pm 0.1	2.15 \pm 0.1	3.5 \pm 0.1	4.0 \pm 0.1	1.4 max.	0.2 to 0.3
P		1.55 \pm 0.1	2.3 \pm 0.1	3.5 \pm 0.05	4.0 \pm 0.1	(1.7 max.)	
A		1.9 \pm 0.1	3.5 \pm 0.1	3.5 \pm 0.05	4.0 \pm 0.1	2.1 $^{max.}_{(1.7)}$	
B		3.3 \pm 0.1	3.8 \pm 0.1	3.5 \pm 0.05	4.0 \pm 0.1	2.4 $^{max.}_{(1.7)}$	
C	12.0 \pm 0.3	3.6 \pm 0.1	6.3 \pm 0.1	5.5 \pm 0.05	8.0 \pm 0.1	2.9 max.	
N		4.8 \pm 0.1	7.7 \pm 0.1	5.5 \pm 0.05	8.0 \pm 0.1	3.5 max.	

Figures in () at t2 are applicable to F92 series.

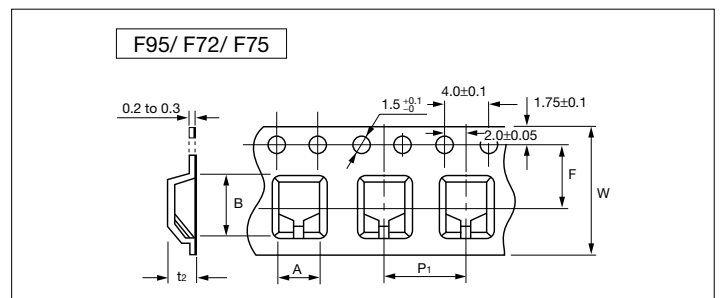

Series	Case size	W	A	B	F	P1	t2
F95	R	8.0 \pm 0.3	1.5 \pm 0.2	2.6 \pm 0.2	3.5 \pm 0.05	4.0 \pm 0.1	1.05 max.
	P		2.0 \pm 0.2	3.6 \pm 0.2			1.5 max.
	Q/ S		2.1 \pm 0.2	3.7 \pm 0.2			2.0 max.
	A		3.0 \pm 0.2	3.75 \pm 0.2			1.5 max.
	T		3.25 \pm 0.2	3.7 \pm 0.2			2.4 max.
F72	R	12.0 \pm 0.3	6.5 \pm 0.2	7.6 \pm 0.2	5.5 \pm 0.1	8.0 \pm 0.1	2.2 max.
	M		6.6 \pm 0.2	7.8 \pm 0.2			2.5 max.
F75	U	12.0 \pm 0.3	3.7 \pm 0.2	7.6 \pm 0.2	5.5 \pm 0.1	8.0 \pm 0.1	2.7 max.
	C		4.8 \pm 0.2	7.9 \pm 0.2			3.6 max.
	D		6.7 \pm 0.2	7.6 \pm 0.2			3.9 max.
	R		6.7 \pm 0.2	7.6 \pm 0.2			4.6 max.

The schematics, graphs and numerical values that appear in our catalog are a representative sampling of typical usage. These will differ due to series, ratings and lot variation. Therefore, please contact us to confirm the specific characteristics.

Note: Series shall be replaced as necessary.

Series	Replaced	Series	Replaced
F91	F91 F91-AJ6	F97	F97 F97-HT3
F93	F93 F93-AJ6	F98	F98 F98-AS1
F95	F95 F95-AM1		

1. Circuit Design

(1) Rated Voltage and Operating Voltage

As shown in Fig.1, rated voltage signifies the maximum peak voltage applied to the capacitor at the maximum rated temperature. The rated voltage consists of the sum of both DC voltage and ripple peak voltage. It is recommended that capacitors are used at a voltage less than the rated voltage. (Reduced rated voltage should be applied at the temperature higher than 85°C)

Fig. 1

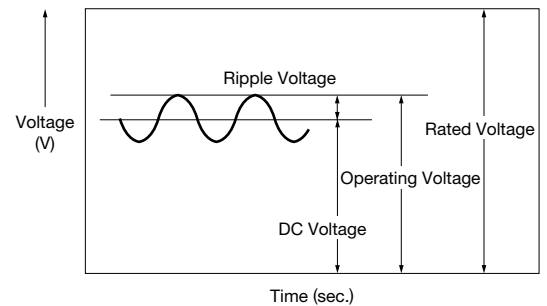

It is also recommended to properly derate the voltage to improve operating reliability.

Fig.2 is commonly used to consider the derated voltage.

Fig. 2

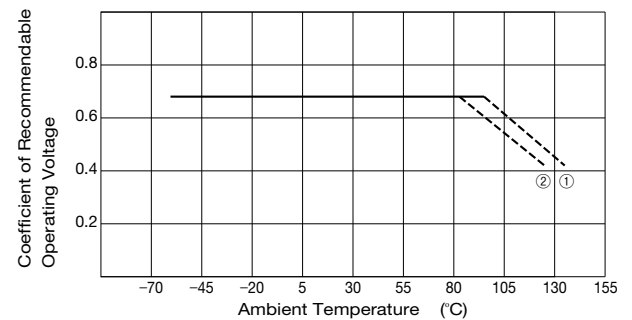

① F97-HT3 series (135°C type)
② Other series (except F38 series)

(2) Low Impedance Circuit

In low impedance circuit applications such as power supply circuits, the failure rate may increase due to inrush current. Additionally, if a short occurs within the capacitor, burning may possibly occur. Therefore, sufficient voltage derating (less than 1/2 of rated voltage) is recommended. If you need assistance, please contact us.

Fig. 3

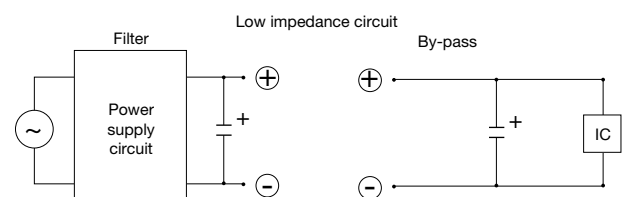

(3) Regarding the applied voltage of conductive polymer tantalum F38 series, we recommend the applied voltage shown in following table.

Recommended operating voltage (Rated voltage ratio)

Type	F38		F38-LZT/ F38-AXE
	6.3V	10V	6.3V
Use in High Impedance circuit	Less than 90%	Less than 80%	Less than 70%
Use in Low Impedance circuit	Less than 90%	Less than 80%	Less than 70%

(4) Operating Temperature

All parts must be used within the specified category temperature range, since, the temperature has a great effect on reliability. Therefore, when using capacitors, please try to keep the temperature as low as possible. Please take into consideration that the capacitor itself generates heat which affects the atmospheric temperature.

(5) Ripple Capability

The ripple capability of solid tantalum electrolytic capacitors is defined by both Equivalent Series Resistance (ESR) and power dissipation due to ripple current.

If the capacitor sees a higher ripple current than specified amount, heat generation within the capacitor will increase eventually causing a failure.

The capacitors should be used at a voltage less than the rated voltage that consists of the sum of both DC voltage and ripple peak voltage. Also, reverse voltage due to variation of ripple peak voltage should not be applied to the capacitor.

If you need detailed information about permissible ripple voltage and permissible ripple current, please contact us.

(6) Reverse Voltage

Solid tantalum electrolytic capacitors are polarized, and therefore, no reverse voltage is acceptable. (Electrical characteristics shall be deteriorated when reverse voltage is applied.) When checking a part using a tester, please make sure the polarity of the tester before the probes touch both capacitor terminals.

(7) Leakage current value differs depending on the voltage applied. Please use higher ratings, especially when it is used in the integration circuit or time-constant circuit.

(8) Low voltage application or high resistance connected to the capacitor in series, a problem could possibly result if the following application exists:

Low voltage, high resistance connected to the capacitor in series, and a circuit is sensitive to leakage current, a problem could occur due to the lower recovery of the leakage current characteristic of tantalum capacitor, caused by heat stress during the soldering process.

(9) Cautions on designing

When tantalum capacitor is used at high frequency circuit, please note that the electrical characteristics may change drastically.

2. Mounting

(1) Recommended mounting pad dimensions for chip type are as shown in Table -1 and Table -2. Dimensions may vary depending upon reflow conditions, type of solder and/or board size.

Fig. 4

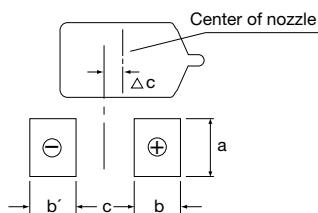

[Cautions when mounting F72, F75, and F95 chip]

Adjustment of Δc toward anode side is required when mounting, as there is a difference between the center of total length of anode tab (\square portion) and the center of board land dimension.

Table-1 Resin - molded chip

Type	F91/ F92/ F93/ F97/ F98/ F98	F91/ F92/ F93/ F97/ F98/ F98	F91/ F92/ F93/ F97/ F98/ F98	F91/ F92/ F93/ F97/ F98/ F98
Case	a	b	b'	c
U	0.35	0.4	0.4	0.4
M	0.65	0.7	0.7	0.6
S	0.9	0.7	0.7	0.8
P	1.0	1.1	1.1	0.4
A	1.3	1.4	1.4	1.0
B	2.3	1.4	1.4	1.3
C	2.3	2.0	2.0	2.7
N	2.5	2.0	2.0	4.0

Table-2 Conformal - coated chip

Type	F95				
Case	a	b	b'	c	Δc
R/ P	1.4	0.6	0.5	0.7	0.2
Q/ S	1.7	0.7	0.6	1.1	0.2
A	1.8	0.7	0.6	1.1	0.2
T	2.6	0.7	0.6	1.2	0.2
B	2.6	0.8	0.7	1.1	0.2

In the case of F95/ F72/ F75 chip mounting, make the centering with the dimensions except anode tab (\square portion) length.

Table-3 Conformal - coated chip

Type	F72/ F75				
Case	a	b	b'	c	Δc
F72 R/ M	5.8	1.2	1.2	3.9	0.5
F75 U/ C	3.0	1.2	1.2	3.3	0.5
F75 D	4.1	1.2	1.2	3.9	0.5
F75 R	5.8	1.2	1.2	3.9	0.5

(2) Soldering temperature and soldering time for chip type should be within limits as shown below when measured at terminal surface.

In case you repeat soldering process more than 1 time, please contact us for advice.

Board size, distribution of reflow temperature and capacitor position on the circuit board will influence to reflow conditions.

Please check actual reflow condition before applying condition shown in Fig. 5. In case you repeat soldering process more than 1 time, please contact us for advice.

■ F72, F75, F91, F92, F93, F95, F97, F98

• Reflow (Infrared Ray, Hot Plate, Hot Air, etc.)

Fig. 5

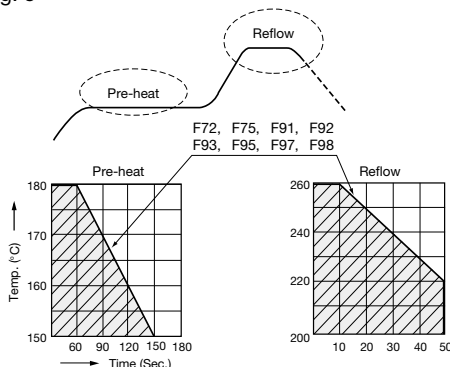

• Flow (Dipping, Wave Soldering, etc.)

Fig. 6

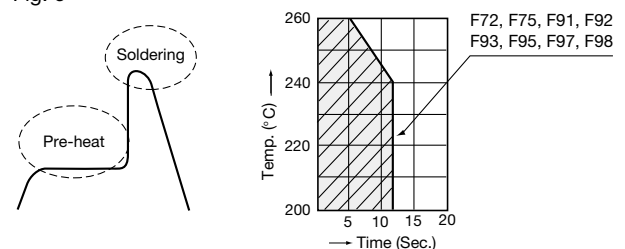

(Pre-heat is subject to "Reflow.")

• Vapor Phase Soldering

30 sec. max. at 215°C (Pre-heat is subject to "Reflow".)
Series : F72, F75, F91, F92, F93, F95, F97, F98

■ F38

• Reflow (Infrared Ray, Hot Plate, Hot Air, etc.)

Fig. 7

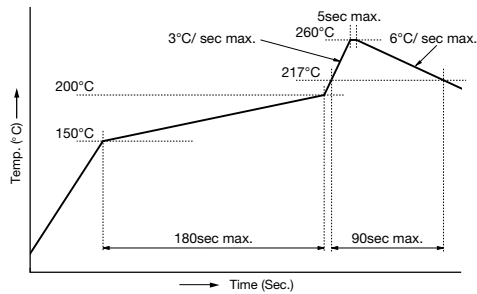

■ All series

• Soldering-iron (30 watts or less)

Fig. 8

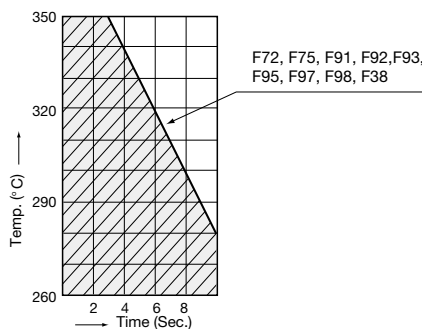

NOTE : Preheat is required to reduce heat shock regardless of the method of soldering. Preheat time for F72, F75, and F95 series should be as long as possible.

(3) Cleaning

Please wash PC board as soon as possible after soldering process to eliminate flux, and acid and alkaline material.

In case of ultrasonic cleaning, attention should be paid to the following:

- ① Cleaning condition : Frequency = 25 to 40kHz, Power = 10 to 20W/l, Time = within 3 minutes.
- ② Do not allow a circuit board to touch the agitator.
- ③ Do not stack circuit boards in the cleaning bath.

3. Notes on Storage

- It is desirable to store capacitors at normal temperatures 35°C Max. and normal humidity.
- Keep out of direct sunlight.
- Don't apply force to capacitor body, especially terminal.
- Don't apply shock and vibration by dropping etc.
- For moisture-proof packed products, keep in sealed storage bag.
- Unseal the storage bag just before mounting and be conscious to use up the capacitors. If some capacitors remained, return the capacitors with desiccant into the storage bag and seal the unsealed part.
- Once the storage bag is opened, store the capacitors in the ambient conditions and time shown in the below table.

MSL	Time	Condition
3	168 hours	≤30°C/ 60%RH

Compliant to IPC/ JEDEC J-STD-020D

- It is preferable to store for no more than 1 year under the above condition.
(when you use part that has been stored more than 1 year, please contact us for assistance)

4. Disposal of capacitors

When disposing, scrap it as industrial wastes.

5. Others

- ① This product has been designed and manufactured for general electronic equipment. If you use them on extremely high quality or safety electronic equipment such as Medical equipment, Aerospace equipment, etc., please contact us for conformity specifications.
- ② The above mentioned material is according to EIAJ RCR-2368B (revised in March 2002, titled "Guideline of notabilia for fixed tantalum electrolytic capacitors with solid electrolyte for use in electronic equipment"). Please refer to this book for details.
- ③ Please refer to AVX individual technical material for further information of ② and contents in this catalog.

■ The correlations among rated voltage, surge voltage and derated voltage are as shown.

F72/ F75/ F91/ F92/ F93/ F95/ F97/ F98

F92-LZT/ F98-LZT/ F98-AXE

F38

F38-LZT/ F38-AXE

Rated voltage (V) [≤85°C]	2.5	4	6.3	10	16	20	25	35
85°C Surge voltage (V)	3.2	5.2	8	13	20	26	32	46
125°C Derated voltage (V)	1.6	2.5	4	6.3	10	13	16	22

Rated voltage (V) [≤60°C]	6.3	10
85°C Derated voltage (V)	4.8	7.2
125°C Derated voltage (V)	2.5	4

Rated voltage (V) [≤85°C]	6.3	10
85°C Surge voltage (V)	8	13
105°C Derated voltage (V)	5	8

Rated voltage (V) [≤60°C]	4	6.3
60°C Surge voltage (V)	—	8
85°C Derated voltage (V)	2.8	4.5
105°C Derated voltage (V)	2	3.3

* In case of F97-HT3, 85°C and 125°C shall be 95°C and 135°C respectively.