

USB Series Varistor



Multilayer Varistors for Universal Serial BUS Protection

GENERAL DESCRIPTION

USB Series varistors are designed to protect the high speed data lines against ESD transients. They have very low capacitance and fast turn on times that make this series ideal for data and transmission lines with high data rates. The unique design enables these devices to meet the rigorous testing criteria of the **IEC 61000-4-2** standards. New and improved manufacturing process has created these USB series to be one of the best plated varistors in the market today.

FEATURES

- Zinc Oxide (ZnO) based ceramic semiconductor devices with non-linear voltage-current characteristics
- Bi-directional device, similar to back-to-back Zener diodes plus an EMC capacitor in parallel
- Entire structure made up of conductive ZnO grains surrounded by electrically insulating barriers, creating varistor-like behavior
- Electrical advantages over Zener diodes are repetitive strike capability, high in rush current capability, fast turn-on-time and EMI attenuation
- Protects against ESD to meet **IEC 61000-4-2** 15kV (air) and 8kV (contact)
- Low capacitance for high speed data lines
- Available in discrete and array packages (2 and 4 element)
- Low Clamping Voltage
- Low Operating Voltage
- Response time is < 1ns

MECHANICAL CHARACTERISTICS

- Available in EIA 0603 (Single), 0405 (Dual) and 0612 (Quad) cases
- Plated Tin over Nickel Barrier
- Packaged in Tape & Reel

PART NUMBERING

USB	0001	D	P
Style	Case Size	Packaging Code (Reel Size)	Termination
	0001 = 0603 (Single)	D = 7" (1,000 pcs.)	P = Ni/Sn Alloy (Plated)
	0002 = 0405 (2-Element)	R = 7" (4,000 pcs.)	
	0004 = 0612 (4-Element)	T = 13" (10,000 pcs.)	
	0005 = 0402 (Single)	W = 7" (10,000 pcs. 0402 only)	
	0006 = 0402 (Single)		

TYPICAL APPLICATIONS

- USB BUS Lines/Firewire Data BUS Lines
- I/O BUS Lines
- 10/100/1000 Ethernet Transmission Lines
- Video Card Data Lines
- Handheld Devices
- Laptop Computers
- LCD Monitors

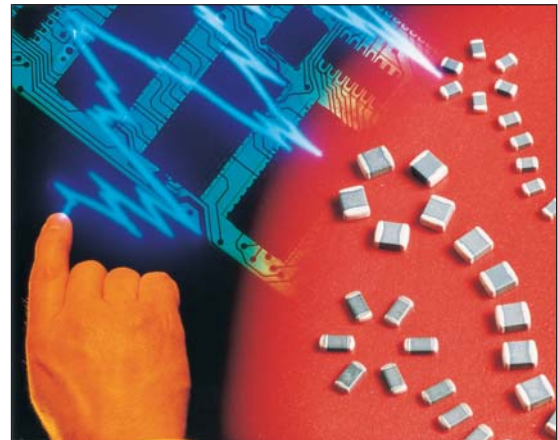

PINOUT CONFIGURATION

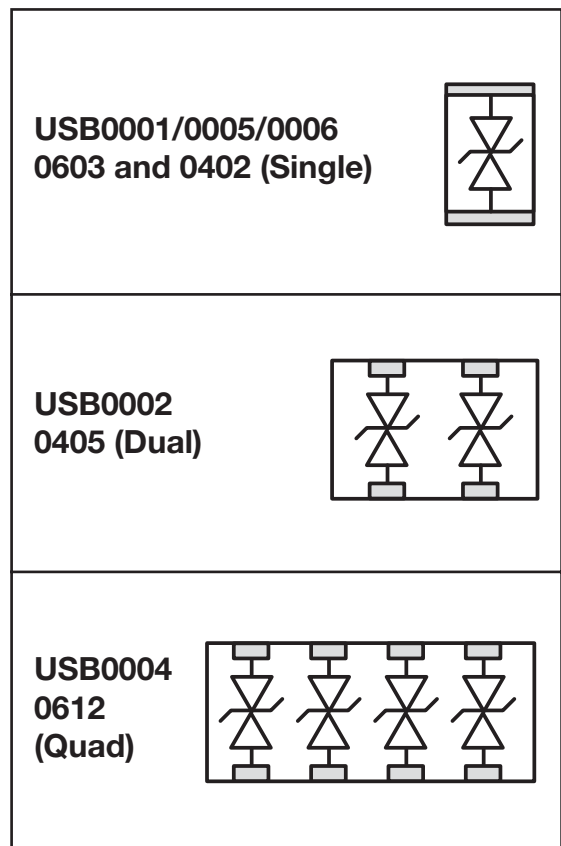

USB Series Varistor



Multilayer Varistors for Universal Serial BUS Protection

RATINGS

Air Discharge ESD	15kV
Contact Discharge ESD	8kV
Operating Temperature	-55°C to +125°C
Soldering Temperature	230°C

PERFORMANCE CHARACTERISTICS

AVX Part No.	V _W (DC)	V _W (AC)	V _B	I _L	E _T	I _p	Cap.	Case Size	Elements
USB0001__	≤18	≤14	120	2	0.015	4	10	0603	1
USB0002__	≤18	≤14	70	2	0.015	4	10	0405	2
USB0004__	≤18	≤14	100	2	0.015	4	10	0612	4
USB0005__	≤18	≤14	300	2	0.015	4	3	0402	1
USB0006__	≤18	≤14	65	2	0.015	4	6	0402	1

└ Termination Finish Code
 └ Packaging Code

- V_W(DC) DC Working Voltage (V)
- V_W(AC) AC Working Voltage (V)
- V_B Typical Breakdown Voltage (V @ 1mA_{DC})
- I_L Maximum Leakage Current at the Working Voltage (μA)
- E_T Transient Energy Rating (J, 10x1000μS)
- I_p Peak Current Rating (A, 8x20μS)
- Cap Typical Capacitance (pF) @ 1 MHz and 0.5Vrms

USB TYPICAL S21 CHARACTERISTICS

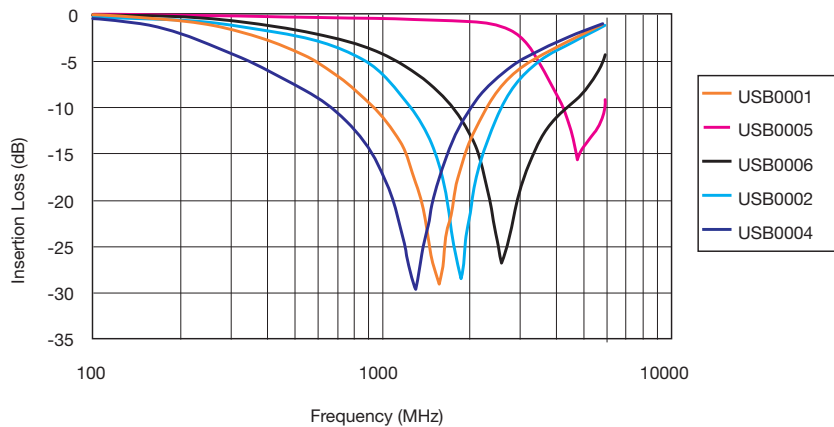

Typical Pulse Rating Curve

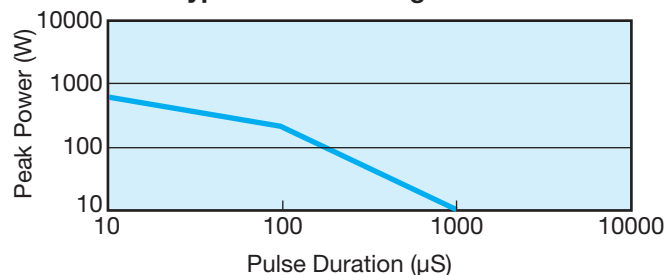

USB Series Varistor



Multilayer Varistors for Universal Serial BUS Protection

PHYSICAL DIMENSIONS AND PAD LAYOUT

USB0001/5/6 (Single)

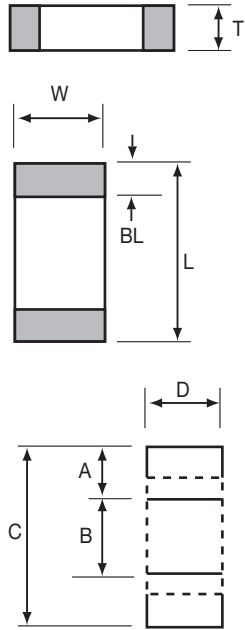

USB0002 (Dual)

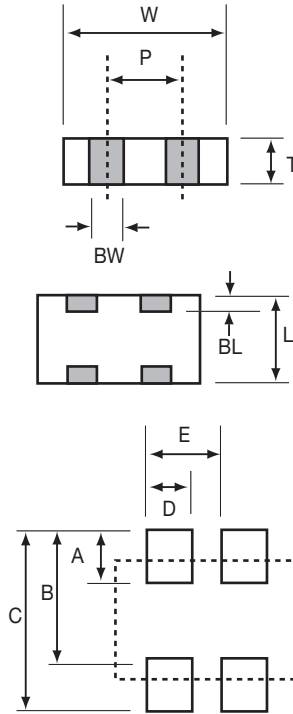

USB0004 (Quad)

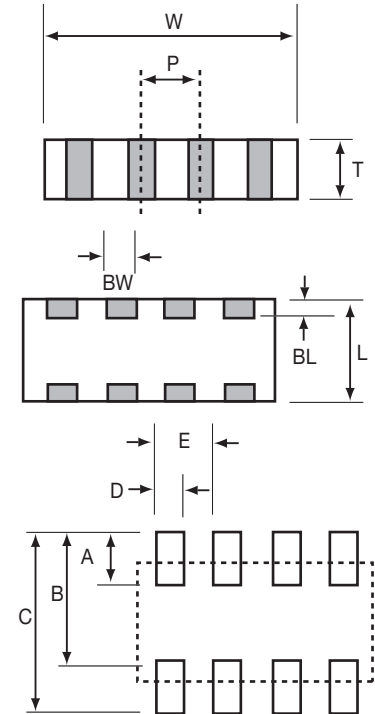

mm (inches)

L	W	T	BW	BL	P
USB0001					
1.60±.15 (0.063±0.006)	0.80±0.15 (0.032±0.006)	0.90 Max (0.035 Max.)	N/A	0.35±0.15 (0.014±0.006)	N/A
USB0002					
1.00±0.15 (0.039±0.006)	1.37±0.15 (0.054±0.006)	0.66 Max (0.026 Max.)	0.36±0.10 (0.014±0.004)	0.20±0.10 (0.008±0.004)	0.64 REF (0.025 REF)
USB0004					
1.60±0.20 (0.063±0.008)	3.20±0.20 (0.126±0.008)	1.22 Max (0.048 Max.)	0.41±0.10 (0.016±0.004)	0.18 ^{+0.25/-0.08} (0.007 ^{+0.01/-0.003})	0.76 REF (0.030 REF)
USB0005 / USB0006					
1.0±0.10 (0.040±0.004)	0.50±0.10 (0.020±0.004)	0.60 Max (0.024 Max.)	N/A	0.25±0.15 (0.010±0.006)	N/A

mm (inches)

A	B	C	D	E
USB0001				
0.89 (0.035)	0.76 (0.030)	2.54 (0.100)	0.76 (0.030)	N/A
USB0002				
0.46 (0.018)	0.74 (0.029)	1.20 (0.047)	0.30 (0.012)	0.64 (0.025)
USB0004				
0.89 (0.035)	1.65 (0.065)	2.54 (0.100)	0.46 (0.018)	0.76 (0.030)
USB0005 / USB0006				
0.61 (0.024)	0.51 (0.020)	1.70 (0.067)	0.51 (0.020)	N/A

USB Series Varistor



Multilayer Varistors for Universal Serial BUS Protection

APPLICATIONS

