

SURFACE MOUNT

- NPO, X7R, Y5V/Z5U dielectric
- All standard chip sizes
- 13" reel size available

Our range of SMD multi-layer ceramic capacitors compliments the leaded capacitors available in radial and axial form.

All product packaging is fully marked with date and lot traceability information.

Most industry standard sizes are available, including 0402 and 1812.

CERAMIC SURFACE MOUNT MULTI - LAYER DS

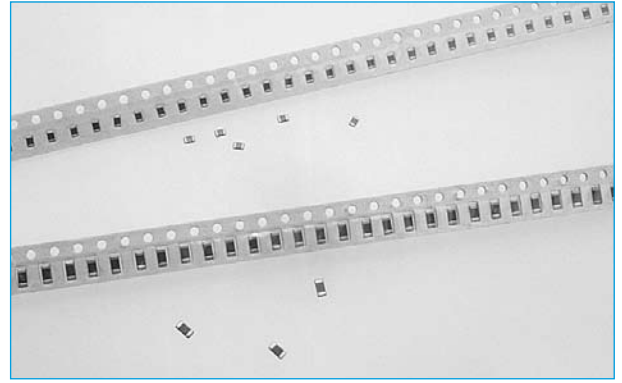

SECTION 1

OUTLINE DRAWING

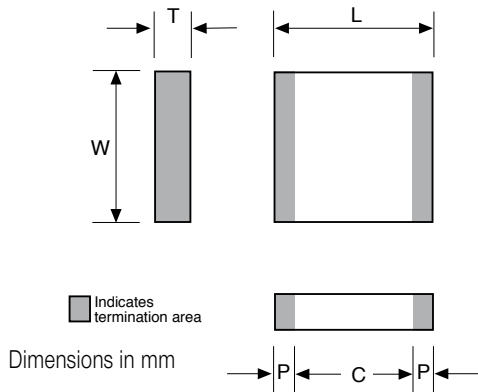

	L	W	T	P
Size Code	mm	mm	mm	mm
0402	1.0±0.1	0.5±0.05	0.6 MAX	0.2
0603	1.6±0.15	0.8±0.1	0.9 MAX	0.3
0805	2.0±0.2	1.25±0.15	1.3 MAX	0.5
1206	3.2±0.2	1.6±0.15	1.3 MAX	0.5
1210	3.2±0.3	2.5±0.3	1.7 MAX	0.5
1812	4.5±0.3	3.2±0.3	1.6 MAX	0.5
2220	5.7±0.4	5±0.4	2.0 MAX	0.5

TOLERANCES

Dielectric materials, capacitance values and tolerances are only available in the following combinations.			
Dielectric	Available Tolerances	Capacitance	Tolerance Codes
COG	± 0.25pF, ± 0.5pF	E12 Values	B = ± 0.1pF
	± 1%		C = ± 0.25pF
	± 2%		D = ± 0.5pF
	± 5%		F = ± 1%
X7R/ X5R	± 5%, ± 20%	E12 Values	G = ± 2%
			J = ± 5%
Y5V	± 20%, -20 + 80%	E6 Values	K = ± 10%
Z5U	± 20%, -20 + 80%	E6 Values	M = ± 20%
			Z = -20 + 80%
			**

ORDERING INFORMATION

DS	U	0805	C	101	J	N
Part	Voltage	Size	Dielectric	Value	Tolerance	Plating
	U = 50/63V	0402	C = NPO	Example	See Above	N = Nickel barrier
	A = 100V	0603	R = X7R	101 = 100pF	**	
	F = 200V	0805	X = X5R	102 = 1nF	for code	
	E = 25V	1206	G = Y5V	103 = 10nF		
	C = 16V	1210	W = Z5U	104 = 100nF		
	B = 10V	1812				
	J = 500V	2220				
	G = 250V					
	D = 6.3V					

RANGE

SECTION 1

ULTRA STABLE CERAMIC CHIP CAPACITORS NICKEL BARRIER TERMINATIONS																	
Dielectric	NPO																
Case Size	0402			0603			0805			1206			1210			1812	
Rated Voltage (VDC)	16	50	100	16	50	100	16	50	100	16	50	100	16	50	100	50	100
0.5pf(0R5)		x	x		x	x		x	x								
1.0pf (1R0)		x	x		x	x		x	x								
1.2pf (1R2)		x	x		x	x		x	x								
1.5pf(1R5)		x	x		x	x		x	x		x	x					
1.8pf (1R8)		x	x		x	x		x	x		x	x					
2.2pf (2R2)		x	x		x	x		x	x		x	x					
2.7pf (2R7)		x	x		x	x		x	x		x	x					
3.3pf (3R3)		x	x		x	x		x	x		x	x					
3.9pf (3R9)		x	x		x	x		x	x		x	x					
4.7pf(4R7)		x	x		x	x		x	x		x	x					
5.6pf (5R6)		x	x		x	x		x	x		x	x					
6.8pf (6R8)		x	x		x	x		x	x		x	x					
8.2pf (8R2)		x	x		x	x		x	x		x	x					
10pf(100)		x	x		x	x		x	x		x	x			x		x
12pf (120)		x	x		x	x		x	x		x	x			x		x
15pf (150)		x	x		x	x		x	x		x	x			x		x
18pf (180)		x	x		x	x		x	x		x	x			x		x
22pf (220)		x	x		x	x		x	x		x	x		x	x		x
27pf (270)		x	x		x	x		x	x		x	x		x	x		x
33pf (330)		x	x		x	x		x	x		x	x		x	x		x
39pf (390)		x	x		x	x		x	x		x	x		x	x		x
47pf (470)		x	x		x	x		x	x		x	x		x	x		x
56pf (560)		x			x	x		x	x		x	x		x	x		x
68pf(680)		x			x	x		x	x		x	x		x	x		x
82pf (820)		x			x	x		x	x		x	x		x	x		x
100pf (101)		x			x	x		x	x		x	x		x	x		x
120pf (121)		x			x			x	x		x	x		x	x		x
150pf (151)		x			x			x	x		x	x		x	x		x
180pf (181)		x			x			x	x		x	x		x	x		x
220pf (221)		x			x			x	x		x	x		x	x		x
270pf (271)	x				x			x	x		x	x		x	x		x
330pf (331)	x				x			x	x		x	x		x	x		x
390pf(391)	x				x			x	x		x	x		x	x		x
470pf (471)	x				x			x	x		x	x		x	x		x
560pf (561)					x			x	x		x	x		x	x		x
680pf (681)					x			x	x		x	x		x	x		x
820pf (821)					x			x	x		x	x		x	x		x
1,000pf (102)					x			x	x		x	x		x	x	x	x
1,200pf (122)				x				x	x		x	x		x	x	x	x
1,500pf (152)				x				x	x		x	x		x	x	x	x
1,800pf (182)				x				x	x		x	x		x	x	x	x
2,200pf (222)				x				x	x		x	x		x	x	x	x
2,700pf (272)				x				x	x		x	x		x	x	x	x
3,300pf (332)				x				x	x		x	x		x	x	x	x
3,900pf (392)								x	x		x	x		x	x	x	x
4,700pf (472)								x			x	x		x	x	x	x
5,600pf (562)								x			x	x		x	x	x	x
6,800pf (682)								x			x	x		x	x	x	x
8,200pf (822)								x			x	x		x	x	x	x
0.01uf (103)								x			x			x	x	x	x
0.012uf (123)											x	x		x	x	x	x
0.015uf (153)											x	x		x	x	x	x
0.018uf (183)											x					x	x
0.022uf (223)											x					x	x
0.027uf (273)											x					x	x
0.033uf (333)											x					x	x
0.039uf (393)											x						

Capacitance

RANGE

STABLE CERAMIC CHIP CAPACITORS NICKEL BARRIER TERMINATIONS																										
Dielectric		X7R																								
Case Size	0402				0603					0805					1206				1210			1812				
Rated Voltage (VDC)	10	16	25	50	10	16	25	50	100	10	16	25	50	100	16	25	50	100	25	50	100	25	50	100		
100pf (101)				x				x	x					x	x											
120pf (121)				x				x	x					x	x											
150pf (151)				x				x	x					x	x				x	x						
180pf(181)				x				x	x					x	x				x	x						
220pf (221)				x				x	x					x	x				x	x						
270pf (271)				x				x	x					x	x				x	x						
330pf (331)				x				x	x					x	x				x	x						
390pf (391)				x				x	x					x	x				x	x						
470pf (471)				x				x	x					x	x				x	x						
560pf (561)				x				x	x					x	x				x	x						
680pf (681)				x				x	x					x	x				x	x						
820pf (821)				x				x	x					x	x				x	x						
1,000pf (102)				x				x	x					x	x				x	x		x	x		x	x
1,200pf (122)				x				x	x					x	x				x	x		x	x		x	x
1,500pf (152)				x				x	x					x	x				x	x		x	x		x	x
1,800pf (182)				x				x	x					x	x				x	x		x	x		x	x
2,200pf (222)				x				x	x					x	x				x	x		x	x		x	x
2,700pf (272)				x				x	x					x	x				x	x		x	x		x	x
3,300pf (332)				x				x	x					x	x				x	x		x	x		x	x
3,900pf (392)				x				x	x					x	x				x	x		x	x		x	x
4,700pf (472)				x				x	x					x	x				x	x		x	x		x	x
5,600pf (562)				x	x			x	x					x	x				x	x		x	x		x	x
6,800pf (682)				x	x			x	x					x	x				x	x		x	x		x	x
8,200pf (822)				x	x			x	x					x	x				x	x		x	x		x	x
0.010uf (103)				x	x			x	x					x	x				x	x		x	x		x	x
0.012uf (123)				x	x			x	x					x	x				x	x		x	x		x	x
0.015uf (153)				x	x			x	x					x	x				x	x		x	x		x	x
0.018uf (183)				x	x			x	x					x	x				x	x		x	x		x	x
0.022uf (223)				x	x	x		x	x					x	x				x	x		x	x		x	x
0.027uf (273)				x				x	x					x	x				x	x		x	x		x	x
0.033uf (333)				x				x	x					x	x				x	x		x	x		x	x
0.039uf (393)				x				x	x					x	x				x	x		x	x		x	x
0.047uf (473)				x				x	x					x	x				x	x		x	x		x	x
0.056uf(563)				x				x	x					x	x				x	x		x	x		x	x
0.068uf (683)				x				x	x					x	x				x	x		x	x		x	x
0.082uf (823)				x				x	x					x	x				x	x		x	x		x	x
0.10uf (104)				x				x	x					x	x				x	x		x	x		x	x
0.12uf (124)								x	x					x	x				x	x		x	x		x	x
0.15uf(154)								x	x					x	x				x	x		x	x		x	x
0.18uf(184)								x	x					x					x	x		x	x		x	x
0.22uf(224)								x	x					x					x	x		x	x		x	x
0.27uf (274)								x						x					x	x		x	x		x	x
0.33uf (334)								x						x					x	x		x	x		x	x
0.39uf (394)								x						x	x				x	x		x	x		x	x
0.47uf (474)								x						x	x				x	x		x	x		x	x
0.56uf (564)														x	x				x	x		x	x		x	x
0.68uf (684)														x	x				x	x		x	x		x	x
0.82uf (824)														x	x				x	x		x	x		x	x
1.0uf (105)														x	x				x	x		x	x		x	x

Capacitance

RANGE

Capacitance	Dielectric	X5R	
	Case Size	0402	
	Rated Voltage (VDC)	10	16
	0.033uf (333)		x
	0.047uf (473)		x
0.1uf (104)	x	x	

For other case sizes and higher 0402 capacitance see DS - High Capacitance.

General Purpose Ceramic Chip Capacitors Y5V/Z5U Nickel Barrier Terminations																			
Dielectric	Y5V/Z5U																		
Case Size	0402				0603				0805				1206		1210		1812		
Rated Voltage (VDC)	10	16	25	50	10	16	25	50	16	25	50	100	25	50	100	50	100	50	100
0.010uf (103)				x				x			x	x	x	x		x		x	
0.015uf (153)				x				x			x	x	x	x		x		x	
0.022uf (223)				x				x			x	x	x	x		x		x	
0.033uf (333)				x				x			x	x	x	x		x		x	
0.047uf (473)		x	x					x			x	x	x	x		x		x	
0.068uf (683)		x	x					x			x	x	x	x		x		x	
0.10uf (104)		x	x					x			x	x	x	x		x	x	x	
0.15uf (154)	x							x			x	x	x	x		x	x	x	
0.22uf (224)	x							x			x		x	x		x	x	x	
0.33uf (334)								x			x		x	x		x	x	x	
0.47uf (474)								x			x		x	x		x	x	x	
0.68uf (684)								x	x				x	x		x	x	x	
1.0uf (105)								x	x				x	x		x	x	x	

TAPE DIMENSIONS (mm)

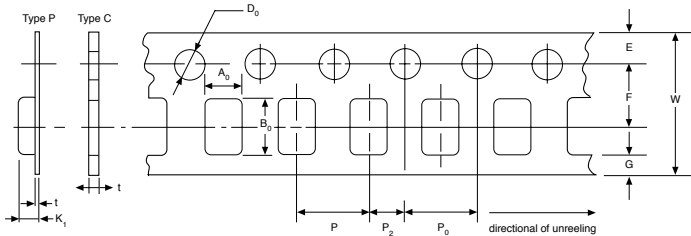

W	Type	DO	P	PO	P2	E	F	G	t
8.0 ± 0.3	C	1.5 +0.1, -0	4.0 ± 0.1	4.0 ± 0.1	2.0 ± 0.05	1.75 ± 0.1	3.5 ± 0.05	0.75 min	1.1 max
8.0 ± 0.3	P	1.5 +0.1, -0	4.0 ± 0.1	4.0 ± 0.1	2.0 ± 0.05	1.75 ± 0.1	3.5 ± 0.05	0.75 min	0.3 max
12.0 ± 0.3	P	1.5 +0.1, -0	8.0 ± 0.1	4.0 ± 0.1	2.0 ± 0.05	1.75 ± 0.1	5.5 ± 0.05	0.75 min	0.1 max

C = Card P = Plastic

REEL DIMENSIONS (mm)

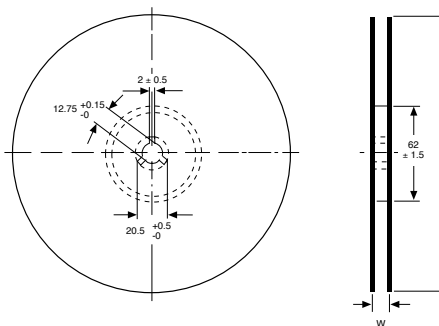

Nom. Tape Width	A	W1
8	180 or 330 +0-2	8.4 +1.5-0
12	180 or 330 +0-2	12.4 +2-0

PERFORMANCE CHARACTERISTICS

PERFORMANCE CHARACTERISTICS					
1. ELECTRICAL					
Dielectric Code	COG	X7R	X5R	Y5V	Z5U
General	COG dielectrics are very stable. Temperature, frequency and time vary little.	X7R dielectrics offer higher capacitance for a given case size than COG.	X5R dielectrics offer higher capacitance for a given case size than X7R.	Y5V dielectrics offer the highest capacitance for a given case size than X5R.	Z5U dielectrics offer the highest capacitance for a given case size than Y5V.
Examples of Applications	Typical applications are in tuned circuits, timing circuits and fast rise time circuits.	Applications would include bypass, coupling and filtering circuits.	Applications would include bypass, coupling and filtering circuits.	Applications would include bypass and decoupling circuits or where temperature dependence is not of major importance.	Applications would include bypass and decoupling circuits or where temperature dependence is not of major importance.
Temperature Range	- 55° to + 125°	-55° to + 125°	- 55° to + 85°	- 25° to + 85°	- 25° to + 85°
Insulation Resistance (I.R.) after 1 min charging at Rated Voltage	> 100G ohms or 1000 sec whichever is less	>100G ohms or 1000 sec whichever is less	>100G ohms or 1000sec whichever is less.	>10G ohms or 100 sec whichever is less.	>10G ohms or 100 sec whichever is less.
Voltage Ratings dc	50, 100, 200, 500	10, 16, 25, 50, 100, 200, 500	10,16,25,50	10, 16, 25, 50, 100	25, 50
Proof Voltage	2.5 x rated voltage	2.5 x rated voltage	2.5 X rated voltage.	2 x rated voltage	2.5 x rated voltage
Max allowable Capacitance Variation over Temperature Range	C > 20pf : 0 ± 00ppm/°C C < 20pF : see CECC 32 101-801	± 15%	± 15%	+30% to - 80%	+22% to - 56%

2. ENVIRONMENT		
Test	Conditions	Requirement
Resistance to soldering heat	Components completely immersed in a solder bath at 260 ± 10° for 5 secs.	25% Max leaching on each edge
Adhesion	Component mounted to substrate a force of 5N applied normal to the line joining the termination and in a line parallel to the substrate.	No visible damage
Rapid change or Temperature	- 55 to 125°C, 5 cycles (1B, 2C1) - 25 to +85°, 5 cycles (2F4)	No visible damage. After recovery
		Δ C/C ≤±1% or pF COG
		Δ C/C ≤±10% X7R
		Δ C/C ≤±10% X5R
		Δ C/C ≤±20% Y5V
		Tan ≤1.5 x specified value
IR. ≤0.25 x specified value		

3. AGEING

Capacitance and impedance will vary depending on circuit operating conditions and the type of dielectric used - typical performance graphs relating to these materials are shown below.

3.1 FREQUENCY

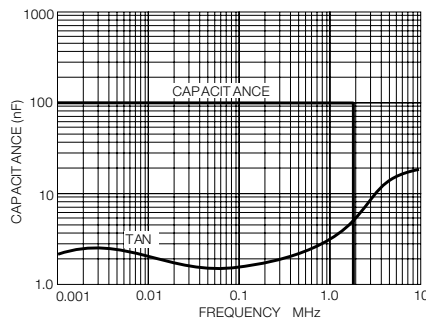
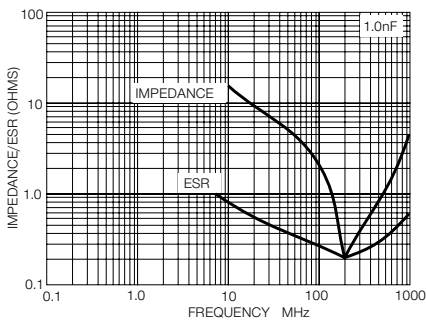
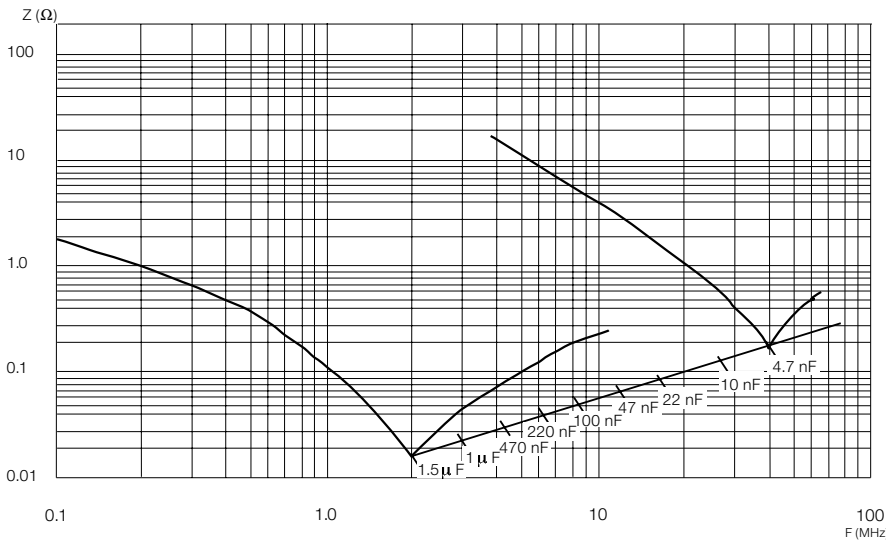
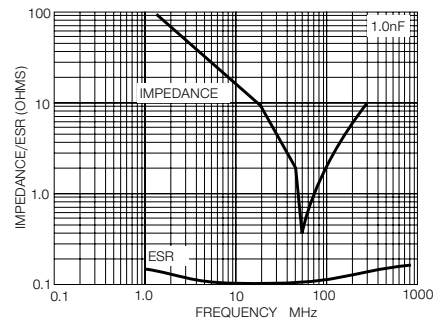
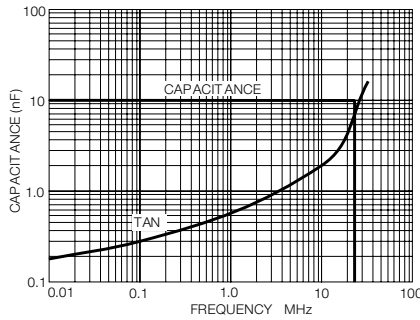
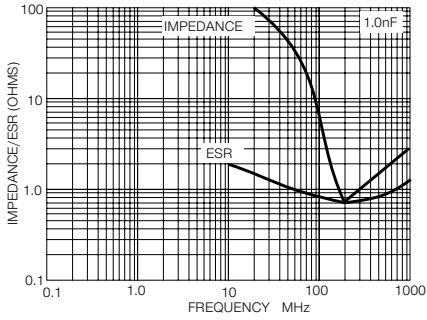

3.2 TEMPERATURE

