

PKU 5000E series  
DC/DC converters, Input 18-72 V, Output up to 10 A/35 W

EN/LZT 146 391 R4B May 2009

© Ericsson AB

**Key Features**

- Industry standard Sixteenth-brick  
33.02 x 22.86 x 7.50 mm (1.3 x 0.9 x 0.295 in.)
- Wide Input range 18-72 V<sub>in</sub>
- High efficiency, typ. 91.7 % at 5 V half load & 27 V<sub>in</sub>
- 1500 V<sub>dc</sub> input to output isolation
- Surface mount option
- Meets safety requirements according to IEC/EN/UL 60950
- More than 1.71 million hours MTBF

**General Characteristics**

- Input under voltage protection
- Over temperature protection
- Output over voltage protection
- Output short circuit protection
- Remote control
- Highly automated manufacturing ensures quality
- ISO 9001/14001 certified supplier



**Safety Approvals**



113613



**Design for Environment**



Meets requirements in high-temperature lead-free soldering processes.

**Contents**

General Information	2
Safety Specification	3
Absolute Maximum Ratings	4
Product Program	Ordering No.
3.3 V/10 A Electrical Specification	PKU 5310E PI ..... 5
5 V/7 A Electrical Specification	PKU 5311E PI ..... 8
12 V/2,75 A Electrical Specification	PKU 5313E PI ..... 11
15 V/2 A Electrical Specification	PKU 5315E PI ..... 14
EMC Specification	17
Operating Information	18
Thermal Consideration	20
Connections	20
Mechanical Information	21
Soldering Information	23
Delivery Package Information	24
Product Qualification Specification	25

PKU 5000E series DC/DC converters, Input 18-72 V, Output up to 10 A/35 W	EN/LZT 146 391 R4B May 2009 © Ericsson AB
-----------------------------------------------------------------------------	----------------------------------------------

## General Information

### Ordering Information

See Contents for individual product ordering numbers.

Option	Suffix	Ordering No.
Surface mount	SI	PKU 5310E SI
Positive Remote Control Logic	P	PKU 5310E PIP
Lead length 3.69 mm (0.145 in)	LA	PKU 5310E PILA
Lead length 4.57 mm (0.180 in)	LB	PKU 5310E PILB
Lead length 5.33 mm (0.210 in)	PI	PKU 5310E PI

Note 1: If several options needed below sequence is to be used: Positive logic option, LA length. Example: PKU 5310E PIPLA

### Reliability

The Mean Time Between Failure (MTBF) is calculated at full output power and an operating ambient temperature ( $T_A$ ) of +40°C. Different methods could be used to calculate the predicted MTBF and failure rate which may give different results. Ericsson Power Modules currently uses two different methods, Ericsson failure rate data system DependTool and Telcordia SR332.

Predicted MTBF for the series is:

- 1.71million hours according to Telcordia SR332, issue 1, Black box technique.

The Ericsson failure rate data system is based on field tracking data. The data corresponds to actual failure rates of components used in Information Technology and Telecom (IT&T) equipment in temperature controlled environments ( $T_A = -5...+65^\circ\text{C}$ ). Telcordia SR332 is a commonly used standard method intended for reliability calculations in IT&T equipment. The parts count procedure used in this method was originally modelled on the methods from MIL-HDBK-217F, Reliability Predictions of Electronic Equipment. It assumes that no reliability data is available on the actual units and devices for which the predictions are to be made, i.e. all predictions are based on generic reliability parameters.

### Compatibility with RoHS requirements

The products are compatible with the relevant clauses and requirements of the RoHS directive 2002/95/EC and have a maximum concentration value of 0.1% by weight in homogeneous materials for lead, mercury, hexavalent chromium, PBB and PBDE and of 0.01% by weight in homogeneous materials for cadmium.

Exemptions in the RoHS directive utilized in Ericsson AB products include:

- Lead in high melting temperature type solder (used to solder the die in semiconductor packages)
- Lead in glass of electronics components and in electronic ceramic parts (e.g. fill material in chip resistors)
- Lead as an alloying element in copper alloy containing up to 4% lead by weight (used in connection pins made of Brass)

### Quality Statement

The products are designed and manufactured in an industrial environment where quality systems and methods like ISO 9000, 6 $\sigma$  (sigma), and SPC are intensively in use to boost the continuous improvements strategy. Infant mortality or early failures in the products are screened out and they are subjected to an ATE-based final test. Conservative design rules, design reviews and product qualifications, plus the high competence of an engaged work force, contribute to the high quality of our products.

### Warranty

Warranty period and conditions are defined in Ericsson AB General Terms and Conditions of Sale.

### Limitation of Liability

Ericsson AB does not make any other warranties, expressed or implied including any warranty of merchantability or fitness for a particular purpose (including, but not limited to, use in life support applications, where malfunctions of product can cause injury to a person's health or life).

PKU 5000E series  
DC/DC converters, Input 18-72 V, Output up to 10 A/35 W

EN/LZT 146 391 R4B May 2009

© Ericsson AB

## Safety Specification

### General information

Ericsson AB DC/DC converters and DC/DC regulators are designed in accordance with safety standards IEC/EN/UL60950, *Safety of Information Technology Equipment*.

IEC/EN/UL60950 contains requirements to prevent injury or damage due to the following hazards:

- Electrical shock
- Energy hazards
- Fire
- Mechanical and heat hazards
- Radiation hazards
- Chemical hazards

On-board DC-DC converters are defined as component power supplies. As components they cannot fully comply with the provisions of any Safety requirements without "Conditions of Acceptability". It is the responsibility of the installer to ensure that the final product housing these components complies with the requirements of all applicable Safety standards and Directives for the final product.

Component power supplies for general use should comply with the requirements in IEC60950, EN60950 and UL60950 "*Safety of information technology equipment*".

There are other more product related standards, e.g. EC61204-7 "Safety standard for power supplies", IEEE802.3af "Ethernet LAN/MAN Data terminal equipment power", and ETS300132-2 "Power supply interface at the input to telecommunications equipment; part 2: DC", but all of these standards are based on IEC/EN/UL60950 with regards to safety.

Ericsson AB DC/DC converters and DC/DC regulators are UL60950 recognized and certified in accordance with EN60950.

The flammability rating for all construction parts of the products meets requirements for V-0 class material according to IEC 60695-11-10.

The products should be installed in the end-use equipment, in accordance with the requirements of the ultimate application. Normally the output of the DC/DC converter is considered as SELV (Safety Extra Low Voltage) and the input source must be isolated by minimum Double or Reinforced Insulation from the primary circuit (AC mains) in accordance with IEC/EN/UL60950.

### Isolated DC/DC converters

It is recommended that a slow blow fuse with a rating twice the maximum input current per selected product be used at the input of each DC/DC converter. If an input filter is used in the circuit the fuse should be placed in front of the input filter.

In the rare event of a component problem in the input filter or in the DC/DC converter that imposes a short circuit on the input source, this fuse will provide the following functions:

- Isolate the faulty DC/DC converter from the input power source so as not to affect the operation of other parts of the system.
- Protect the distribution wiring from excessive current and power loss thus preventing hazardous overheating.

The galvanic isolation is verified in an electric strength test. The test voltage ( $V_{iso}$ ) between input and output is 1500 Vdc or 2250 Vdc for 60 seconds (refer to Absolute maximum ratings). Leakage current is less than 100  $\mu$ A at nominal input voltage.

### 24 V DC systems

The input voltage to the DC/DC converter is SELV (Safety Extra Low Voltage) and the output remains SELV under normal and abnormal operating conditions.

### 48 and 60 V DC systems

If the input voltage to Ericsson AB DC/DC converter is 75 Vdc or less, then the output remains SELV (Safety Extra Low Voltage) under normal and abnormal operating conditions.

Single fault testing in the input power supply circuit should be performed with the DC/DC converter connected to demonstrate that the input voltage does not exceed 75 Vdc.

If the input power source circuit is a DC power system, the source may be treated as a TNV2 circuit and testing has demonstrated compliance with SELV limits and isolation requirements equivalent to Basic Insulation in accordance with IEC/EN/UL60950.

### Non-isolated DC/DC regulators

The input voltage to the DC/DC regulator is SELV (Safety Extra Low Voltage) and the output remains SELV under normal and abnormal operating conditions.

PKU 5000E series DC/DC converters, Input 18-72 V, Output up to 10 A/35 W	EN/LZT 146 391 R4B May 2009
	© Ericsson AB

**Absolute Maximum Ratings**

Characteristics		min	typ	max	Unit
$T_{P1}$	Operating Temperature (see Thermal Consideration section)	-40		+105	°C
$T_S$	Storage temperature	-55		+100	°C
$V_I$	Input voltage	-0.5		+80	V
$V_{iso}$	Isolation voltage (input to output test voltage)			1500	Vdc
$V_{tr}$	Input voltage transient ( $t_p$ 100 ms)			100	V
$V_{RC}$	Remote Control pin voltage (see Operating Information section)	Positive logic option		40	V
		Negative logic option	-0.5	40	V
$V_{adj}$	Adjust pin voltage (see Operating Information section)	-0.5		$2 \times V_{oi}$	V

Stress in excess of Absolute Maximum Ratings may cause permanent damage. Absolute Maximum Ratings, sometimes referred to as no destruction limits, are normally tested with one parameter at a time exceeding the limits of Output data or Electrical Characteristics. If exposed to stress above these limits, function and performance may degrade in an unspecified manner.

**Fundamental Circuit Diagram**

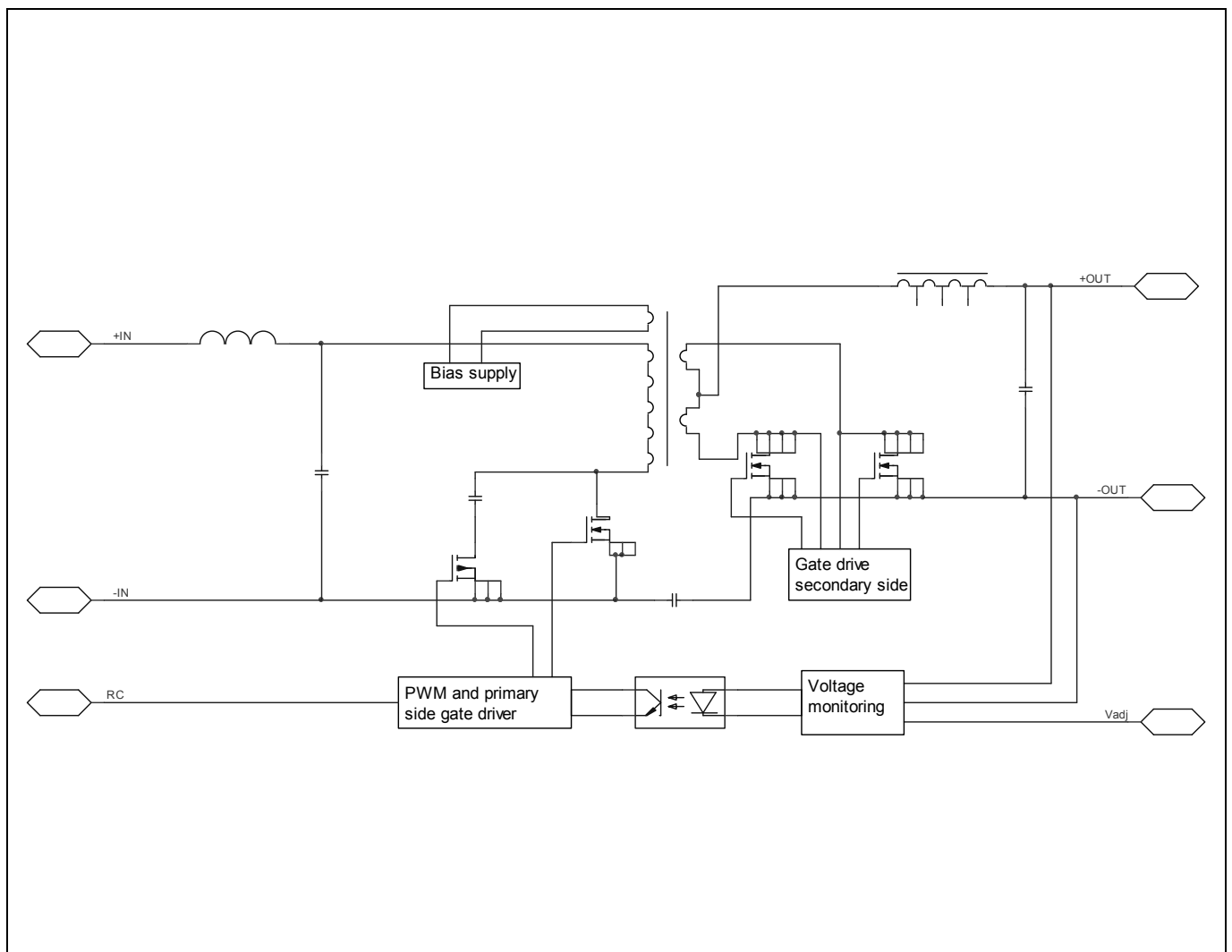

PKU 5000E series DC/DC converters, Input 18-72 V, Output up to 10 A/35 W	EN/LZT 146 391 R4B May 2009
	© Ericsson AB

### 3.3 V/10 A Electrical Specification

### PKU 5310E PI

$T_{P1} = -30$  to  $+90^{\circ}\text{C}$ ,  $V_I = 18$  to  $72$  V, unless otherwise specified under Conditions.

Typical values given at:  $T_{P1} = +25^{\circ}\text{C}$ ,  $V_I = 53$  V,  $I_O = \text{max } I_O$ , unless otherwise specified under Conditions.

Additional  $C_O = 220$   $\mu\text{F}$ .

Characteristics		Conditions	min	typ	max	Unit
$V_I$	Input voltage range		18		72	V
$V_{\text{loff}}$	Turn-off input voltage	Decreasing input voltage	15	16	17	V
$V_{\text{lon}}$	Turn-on input voltage	Increasing input voltage	16	17	18	V
$C_I$	Internal input capacitance			4.4		$\mu\text{F}$
$P_O$	Output power	Output voltage initial setting	0		33	W
$\eta$	Efficiency	50 % of max $I_O$ , $V_I = 27$ V		89.4		%
		max $I_O$ , $V_I = 27$ V		89.2		
		50 % of max $I_O$ , $V_I = 53$ V		87.3		
		max $I_O$ , $V_I = 53$ V		88.1		
$P_d$	Power Dissipation	max $I_O$		4.4	7.5	W
$P_{\text{li}}$	Input idling power	$I_O = 0$ A, $V_I = 53$ V		1.8		W
$P_{\text{RC}}$	Input standby power	$V_I = 53$ V (turned off with RC)		0.65		W
$f_s$	Switching frequency	0-100 % of max $I_O$	255	285	315	kHz

$V_{O_i}$	Output voltage initial setting and accuracy	$T_{P1} = +25^{\circ}\text{C}$ , $V_I = 53$ V, $I_O = 10$ A	3.24	3.30	3.36	V
$V_O$	Output adjust range	See operating information	2.97		3.63	V
	Output voltage tolerance band	10-100 % of max $I_O$	3.20		3.40	V
	Idling voltage	$I_O = 0$ A	3.24		3.36	V
	Line regulation	max $I_O$		$\pm 5$	$\pm 25$	mV
	Load regulation	$V_I = 53$ V, 0-100 % of max $I_O$		$\pm 5$	$\pm 25$	mV
$V_{\text{tr}}$	Load transient voltage deviation	$V_I = 53$ V, Load step 25-75-25 % of max $I_O$ , $di/dt = 5$ A/ $\mu\text{s}$ , $C_O = 1$ mF		$\pm 250$	$\pm 400$	mV
$t_{\text{tr}}$	Load transient recovery time			250	400	$\mu\text{s}$
$t_r$	Ramp-up time (from 10-90 % of $V_{O_i}$ )	10-100 % of max $I_O$		7		ms
$t_s$	Start-up time (from $V_I$ connection to 90 % of $V_{O_i}$ )			8		ms
$t_f$	$V_I$ shut-down fall time (from $V_I$ off to 10 % of $V_O$ )	max $I_O$		2		ms
		$I_O = 0$ A		15		s
$t_{\text{RC}}$	RC start-up time	max $I_O$		8		ms
	RC shut-down fall time (from RC off to 10 % of $V_O$ )	max $I_O$		0.35		ms
		$I_O = 0$ A		15		s
$I_O$	Output current		0		10	A
$I_{\text{lim}}$	Current limit threshold	$V_I = 53$ V, $T_{P1} < \text{max } T_{P1}$		15	20	A
$I_{\text{sc}}$	Short circuit current	$T_{P1} = 25^{\circ}\text{C}$ , Note 1		18		A
$V_{\text{Oac}}$	Output ripple & noise	See ripple & noise section, max $I_O$ , $V_{O_i}$ , $C_O = 220$ $\mu\text{F}$		45	80	mVp-p
OVP	Over voltage protection	$T_{P1} = +25^{\circ}\text{C}$ , $V_I = 53$ V, 0-100 % of max $I_O$		3.9		V

1) RMS value

PKU 5000E series  
DC/DC converters, Input 18-72 V, Output up to 10 A/35 W

EN/LZT 146 391 R4B May 2009

© Ericsson AB

**3.3 V/10 A Typical Characteristics**

**PKU 5310E PI**

**Efficiency**

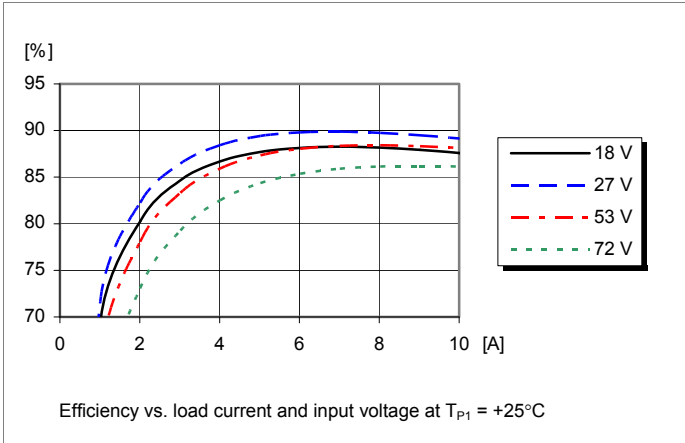

**Power Dissipation**

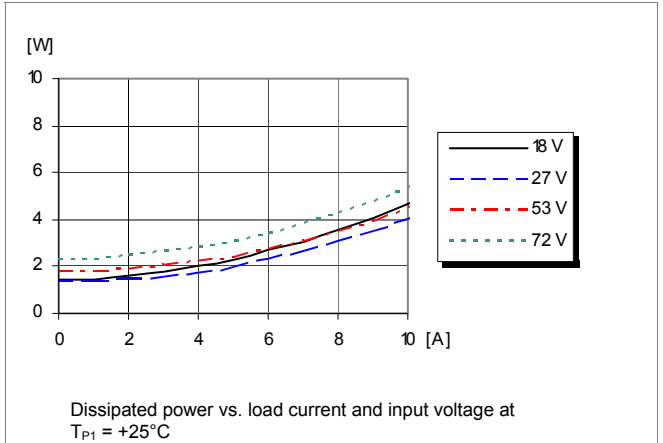

**Output Characteristics**

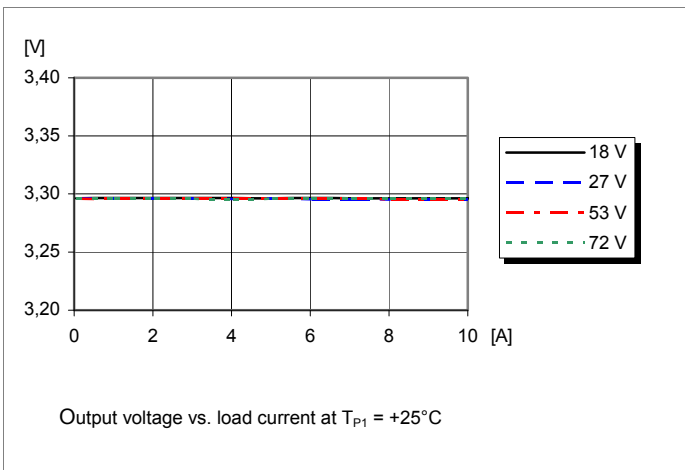

**Current Limit Characteristics**

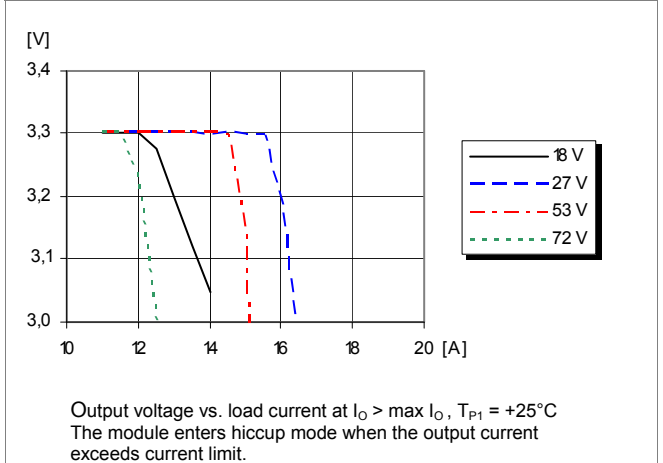

**Output Current Derating**

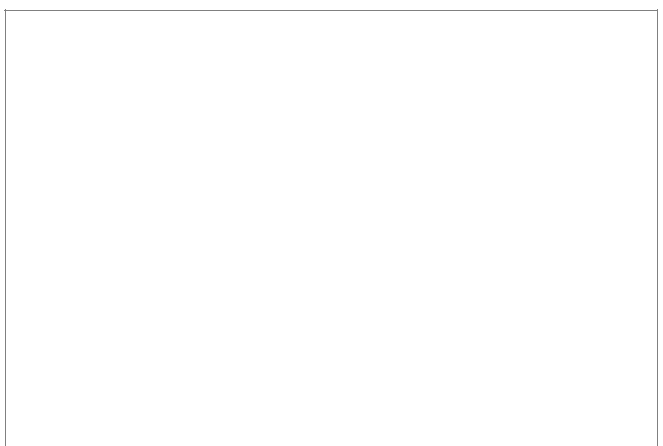
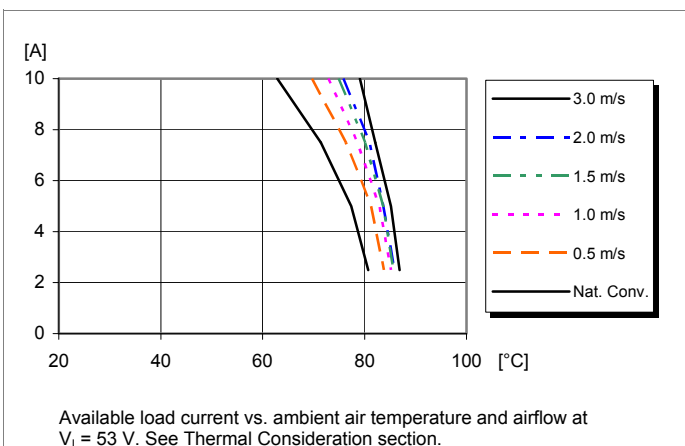

PKU 5000E series  
DC/DC converters, Input 18-72 V, Output up to 10 A/35 W

EN/LZT 146 391 R4B May 2009

© Ericsson AB

**3.3 V/10 A Typical Characteristics**

**PKU 5310E PI**

**Start-up**

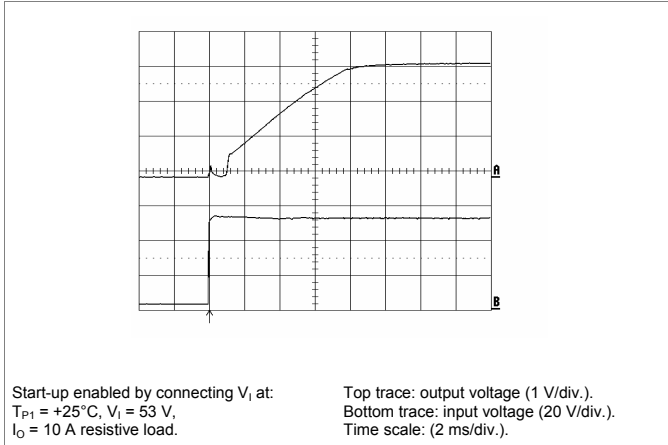

**Shut-down**

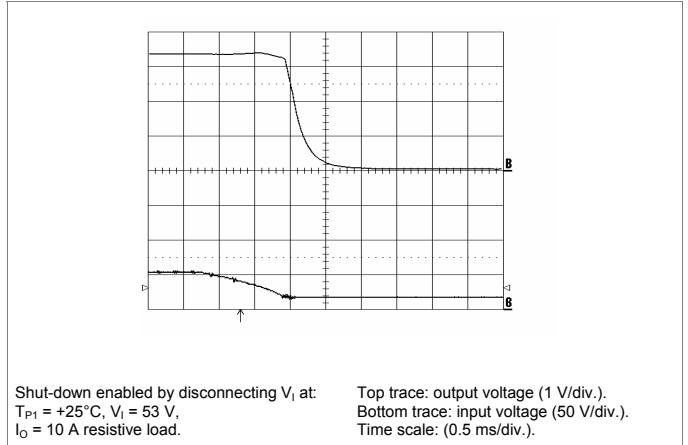

**Output Ripple & Noise**

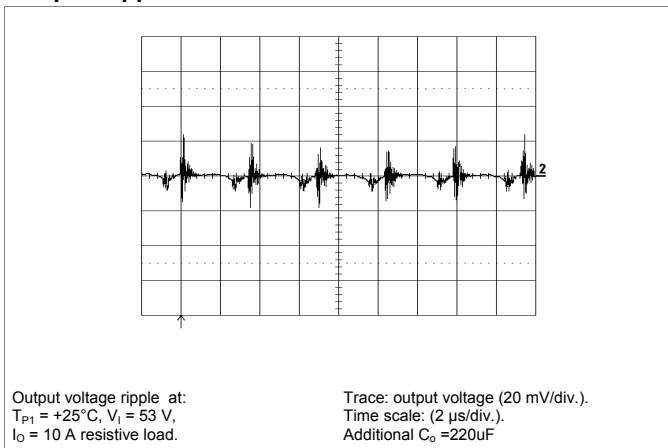

**Output Load Transient Response**

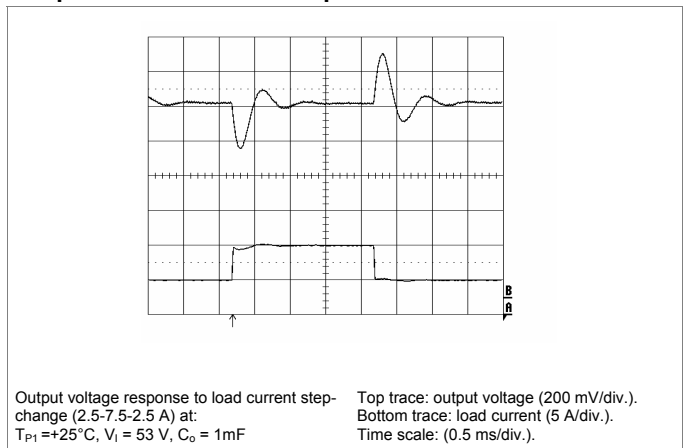

**Output Voltage Adjust (see operating information)**

**Passive adjust**

The resistor value for an adjusted output voltage is calculated by using the following equations:

Output Voltage Adjust Upwards, Increase:

$$R_{adj} = \left( \frac{5.11 \times 3.30(100 + \Delta\%)}{1.225 \times \Delta\%} - \frac{511}{\Delta\%} - 10.22 \right) \text{ k}\Omega$$

Example: Increase 4% =>  $V_{out} = 3.432\text{ Vdc}$

$$\left( \frac{5.11 \times 3.30(100 + 4)}{1.225 \times 4} - \frac{511}{4} - 10.22 \right) \text{ k}\Omega = 220\text{ k}\Omega$$

**Active adjust**

The output voltage may be adjusted using a voltage applied to the Vadj pin. This voltage is calculated by using the following equations:

$$V_{adj} = \left( 1.225 + 2.45 \times \frac{V_{desired} - 3.30}{3.30} \right) \text{ V}$$

Example: Upwards => 3.50 V

$$\left( 1.225 + 2.45 \times \frac{3.50 - 3.30}{3.30} \right) \text{ V} = 1.37\text{ V}$$

PKU 5000E series DC/DC converters, Input 18-72 V, Output up to 10 A/35 W	EN/LZT 146 391 R4B May 2009
	© Ericsson AB

**5 V/7 A Electrical Specification**
**PKU 5311E PI**

$T_{P1} = -30$  to  $+90^{\circ}\text{C}$ ,  $V_I = 18$  to  $72$  V, unless otherwise specified under Conditions.

Typical values given at:  $T_{P1} = +25^{\circ}\text{C}$ ,  $V_I = 53$  V,  $I_O = \text{max } I_O$ , unless otherwise specified under Conditions.

Additional  $C_O = 150$   $\mu\text{F}$ .

Characteristics		Conditions	min	typ	max	Unit
$V_I$	Input voltage range		18		72	V
$V_{\text{loff}}$	Turn-off input voltage	Decreasing input voltage	15	16	17	V
$V_{\text{lon}}$	Turn-on input voltage	Increasing input voltage	16	17	18	V
$C_I$	Internal input capacitance			4.4		$\mu\text{F}$
$P_O$	Output power	Output voltage initial setting	0		35	W
$\eta$	Efficiency	50 % of max $I_O$ , $V_I = 27$ V		91.7		%
		max $I_O$ , $V_I = 27$ V		91.0		
		50 % of max $I_O$ , $V_I = 53$ V		89.4		
		max $I_O$ , $V_I = 53$ V		90.5		
$P_d$	Power Dissipation	max $I_O$		3.8	5.6	W
$P_{\text{li}}$	Input idling power	$I_O = 0$ A, $V_I = 53$ V		1.6		W
$P_{\text{RC}}$	Input standby power	$V_I = 53$ V (turned off with RC)		0.5		W
$f_s$	Switching frequency	0-100 % of max $I_O$	255	285	315	kHz

$V_{\text{Oi}}$	Output voltage initial setting and accuracy	$T_{P1} = +25^{\circ}\text{C}$ , $V_I = 53$ V, $I_O = 7$ A	4.9	5	5.1	V
$V_O$	Output adjust range	See operating information	4.5		5.5	V
	Output voltage tolerance band	10-100 % of max $I_O$	4.85		5.15	V
	Idling voltage	$I_O = 0$ A	4.9		5.1	V
	Line regulation	max $I_O$		$\pm 5$	$\pm 25$	mV
	Load regulation	$V_I = 53$ V, 0-100 % of max $I_O$		$\pm 5$	$\pm 25$	mV
$V_{\text{tr}}$	Load transient voltage deviation	$V_I = 53$ V, Load step 25-75-25 % of max $I_O$ , $di/dt = 5$ A/ $\mu\text{s}$ , $C_O = 700$ $\mu\text{F}$		$\pm 300$	$\pm 500$	mV
$t_{\text{tr}}$	Load transient recovery time			250	400	$\mu\text{s}$
$t_r$	Ramp-up time (from 10-90 % of $V_{\text{Oi}}$ )	10-100 % of max $I_O$		5.0	15	ms
$t_s$	Start-up time (from $V_I$ connection to 90 % of $V_{\text{Oi}}$ )			6.5	20	ms
$t_f$	$V_I$ shut-down fall time (from $V_I$ off to 10 % of $V_O$ )	max $I_O$	0.2	2		ms
		$I_O = 0$ A		1.4		s
$t_{\text{RC}}$	RC start-up time	max $I_O$		7.0		ms
	RC shut-down fall time (from RC off to 10 % of $V_O$ )	max $I_O$	0.2	0.4		ms
		$I_O = 0$ A		2.3		s
$I_O$	Output current		0		7	A
$I_{\text{lim}}$	Current limit threshold	$V_I = 53$ V, $T_{P1} < \text{max } T_{P1}$		11	14.5	A
$I_{\text{sc}}$	Short circuit current	$T_{P1} = 25^{\circ}\text{C}$ , Note 1		12		A
$V_{\text{Oac}}$	Output ripple & noise	See ripple & noise section, max $I_O$ , $V_{\text{Oi}}$ , $C_O = 220$ $\mu\text{F}$		25	60	mVp-p
OVP	Over voltage protection	$T_{P1} = +25^{\circ}\text{C}$ , $V_I = 53$ V, 0-100 % of max $I_O$		7		V

1) RMS value



PKU 5000E series  
DC/DC converters, Input 18-72 V, Output up to 10 A/35 W

EN/LZT 146 391 R4B May 2009

© Ericsson AB

**5 V/7 A Typical Characteristics**

**PKU 5311E PI**

**Efficiency**

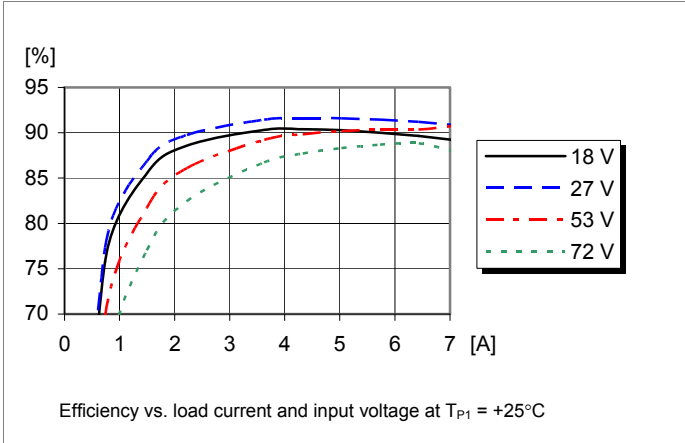

**Power Dissipation**

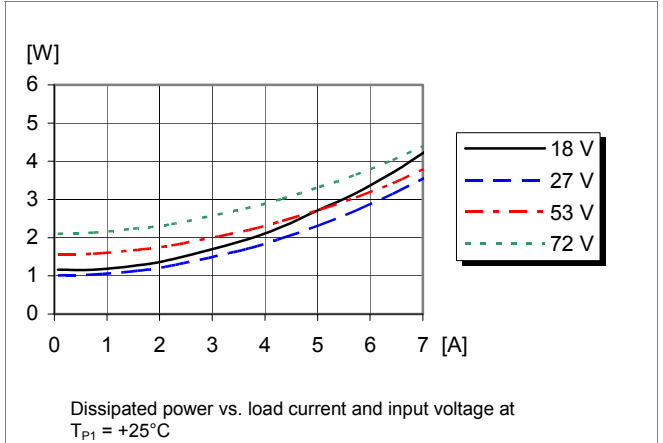

**Output Characteristics**

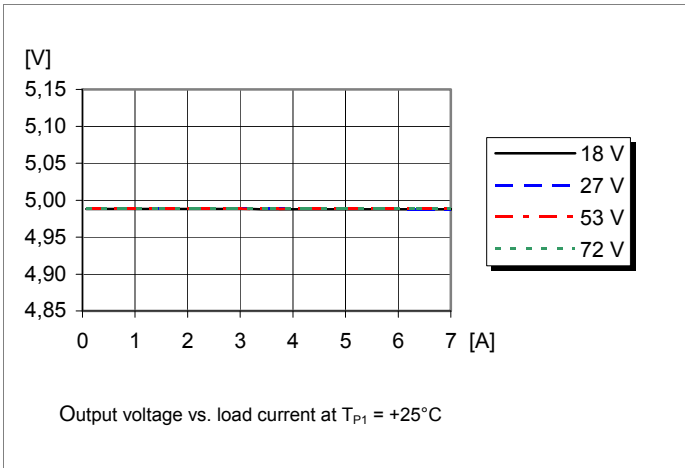

**Current Limit Characteristics**

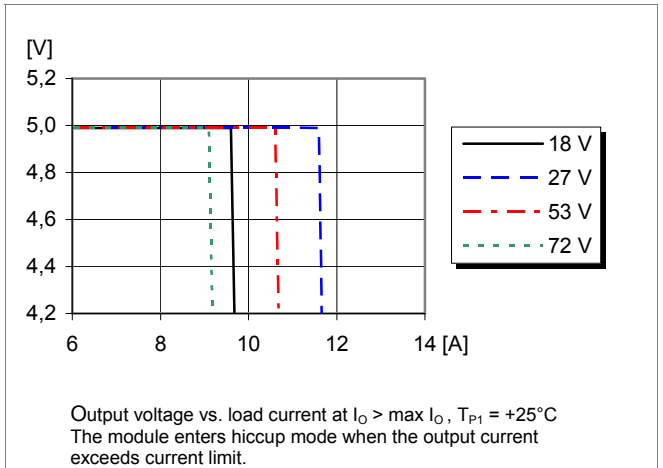

**Output Current Derating**

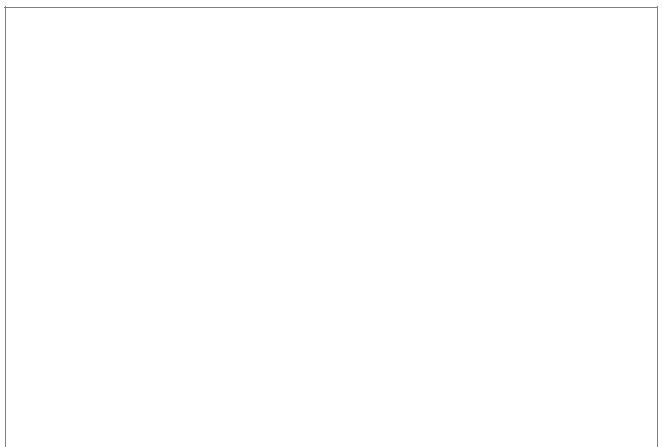
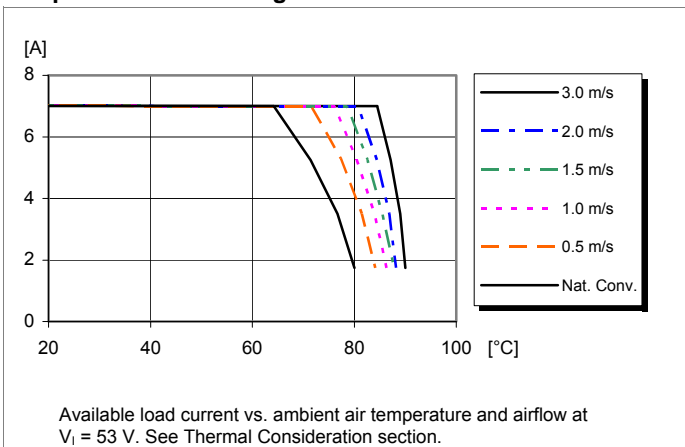

PKU 5000E series  
DC/DC converters, Input 18-72 V, Output up to 10 A/35 W

EN/LZT 146 391 R4B May 2009  
© Ericsson AB

**5 V/7 A Typical Characteristics**

**PKU 5311E PI**

**Start-up**

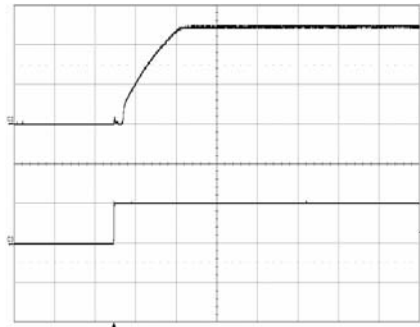

Start-up enabled by connecting  $V_i$  at:  
 $T_{P1} = +25^\circ\text{C}$ ,  $V_i = 53\text{ V}$ ,  
 $I_o = 7\text{ A}$  load.

Top trace: output voltage (2 V/div.).  
Bottom trace: input voltage (50 V/div.).  
Time scale: (5 ms/div.).

**Shut-down**

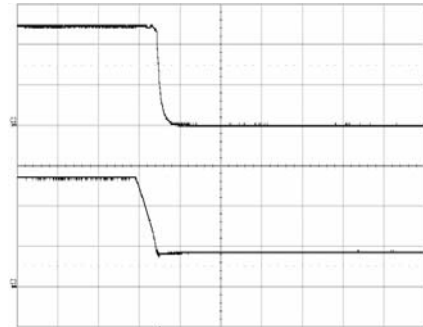

Shut-down enabled by disconnecting  $V_i$  at:  
 $T_{P1} = +25^\circ\text{C}$ ,  $V_i = 53\text{ V}$ ,  
 $I_o = 7\text{ A}$  resistive load.

Top trace: output voltage (2 V/div.).  
Bottom trace: input voltage (20 V/div.).  
Time scale: (2 ms/div.).

**Output Ripple & Noise**

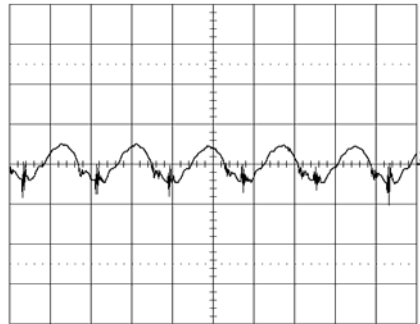

Output voltage ripple at:  
 $T_{P1} = +25^\circ\text{C}$ ,  $V_i = 53\text{ V}$ ,  
 $I_o = 7\text{ A}$  resistive load.

Trace: output voltage (20 mV/div.).  
Time scale: (2  $\mu\text{s}$ /div.).  
Additional  $C_o = 220\mu\text{F}$

**Output Load Transient Response**

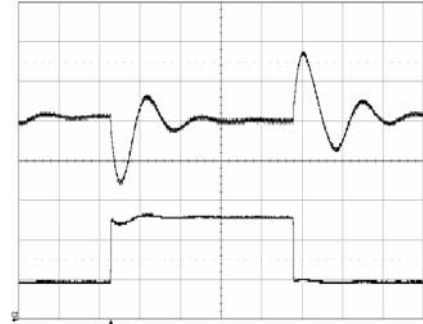

Output voltage response to load current step-  
change (1.75 - 5.25 - 1.75 A) at:  
 $T_{P1} = +25^\circ\text{C}$ ,  $V_i = 53\text{ V}$ ,  $C_o = 690\ \mu\text{F}$

Top trace: output voltage (200 mV/div.).  
Bottom trace: load current (2 A/div.).  
Time scale: (0.5 ms/div.).

**Output Voltage Adjust (see operating information)**

**Passive adjust**

The resistor value for an adjusted output voltage is calculated by using the following equations:

Output Voltage Adjust Upwards, Increase:

$$R_{adj} = \left( \frac{5.11 \times 5.0(100 + \Delta\%)}{1.225 \times \Delta\%} - \frac{511}{\Delta\%} - 10.22 \right) \text{ k}\Omega$$

Example: Increase 4% =>  $V_o = 5.2\text{ Vdc}$

$$\left( \frac{5.11 \times 5.0(100 + 4)}{1.225 \times 4} - \frac{511}{4} - 10.22 \right) \text{ k}\Omega = 404 \text{ k}\Omega$$

**Active adjust**

The output voltage may be adjusted using a voltage applied to the  $V_{adj}$  pin. This voltage is calculated by using the following equations:

$$V_{adj} = \left( 1.225 + 2.45 \times \frac{V_{desired} - 5.0}{5.0} \right) \text{ V}$$

Example: Upwards => 5.2 V

$$\left( 1.225 + 2.45 \times \frac{5.2 - 5.0}{5.0} \right) \text{ V} = 1.323 \text{ V}$$

PKU 5000E series DC/DC converters, Input 18-72 V, Output up to 10 A/35 W	EN/LZT 146 391 R4B May 2009
	© Ericsson AB

**12 V/2.75 A Electrical Specification**
**PKU 5313E PI**

$T_{P1} = -30$  to  $+90^{\circ}\text{C}$ ,  $V_I = 18$  to  $72$  V, unless otherwise specified under Conditions.

Typical values given at:  $T_{P1} = +25^{\circ}\text{C}$ ,  $V_I = 53$  V,  $I_O = \text{max } I_O$ , unless otherwise specified under Conditions.

Additional  $C_O = 47$   $\mu\text{F}$ .

Characteristics		Conditions	min	typ	max	Unit
$V_I$	Input voltage range		18		72	V
$V_{\text{loff}}$	Turn-off input voltage	Decreasing input voltage	15	16	17	V
$V_{\text{lon}}$	Turn-on input voltage	Increasing input voltage	16	17	18	V
$C_I$	Internal input capacitance			4.4		$\mu\text{F}$
$P_O$	Output power	Output voltage initial setting	0		33	W
$\eta$	Efficiency	50 % of max $I_O$ , $V_I = 27$ V		88.8		%
		max $I_O$ , $V_I = 27$ V		89.2		
		50 % of max $I_O$ , $V_I = 53$ V		85.6		
		max $I_O$ , $V_I = 53$ V		88.0		
$P_d$	Power Dissipation	max $I_O$		4.8	8.2	W
$P_{\text{li}}$	Input idling power	$I_O = 0$ A, $V_I = 53$ V		2.2		W
$P_{\text{RC}}$	Input standby power	$V_I = 53$ V (turned off with RC)		0.4		W
$f_s$	Switching frequency	0-100 % of max $I_O$	255	285	315	kHz

$V_{\text{Oi}}$	Output voltage initial setting and accuracy	$T_{P1} = +25^{\circ}\text{C}$ , $V_I = 53$ V, $I_O = 2.75$ A	11.76	12.0	12.24	V
$V_O$	Output adjust range	See operating information	10.8		13.2	V
	Output voltage tolerance band	10-100 % of max $I_O$	11.64		12.36	V
	Idling voltage	$I_O = 0$ A	11.76		12.24	V
	Line regulation	max $I_O$		$\pm 5$	$\pm 50$	mV
	Load regulation	$V_I = 53$ V, 0-100 % of max $I_O$		$\pm 5$	$\pm 50$	mV
$V_{\text{tr}}$	Load transient voltage deviation	$V_I = 53$ V, Load step 25-75-25 % of max $I_O$ , $di/dt = 5$ A/ $\mu\text{s}$ , $C_O = 275$ $\mu\text{F}$		$\pm 400$	$\pm 600$	mV
$t_{\text{tr}}$	Load transient recovery time			75	150	$\mu\text{s}$
$t_r$	Ramp-up time (from 10-90 % of $V_{\text{Oi}}$ )	10-100 % of max $I_O$		5		ms
$t_s$	Start-up time (from $V_I$ connection to 90 % of $V_{\text{Oi}}$ )			7		ms
$t_f$	$V_I$ shut-down fall time (from $V_I$ off to 10 % of $V_O$ )	max $I_O$	0.4	0.6		ms
		$I_O = 0$ A		1		s
$t_{\text{RC}}$	RC start-up time	max $I_O$		30		ms
	RC shut-down fall time (from RC off to 10 % of $V_O$ )	max $I_O$	0.4	0.6		ms
		$I_O = 0$ A		0.7		s
$I_O$	Output current		0		2.75	A
$I_{\text{lim}}$	Current limit threshold	$V_I = 53$ V, $T_{P1} < \text{max } T_{P1}$		4.3	5.6	A
$I_{\text{sc}}$	Short circuit current	$T_{P1} = 25^{\circ}\text{C}$ , Note 1		8.6		A
$V_{\text{Oac}}$	Output ripple & noise	See ripple & noise section, max $I_O$ , $V_{\text{Oi}}$ , $C_O = 47$ $\mu\text{F}$		25	50	mVp-p
OVP	Over voltage protection	$T_{P1} = +25^{\circ}\text{C}$ , $V_I = 53$ V, 0-100 % of max $I_O$		16		V

1) RMS value

PKU 5000E series  
DC/DC converters, Input 18-72 V, Output up to 10 A/35 W

EN/LZT 146 391 R4B May 2009  
© Ericsson AB

**12 V/2.75 A Typical Characteristics**

**PKU 5313E PI**

**Efficiency**

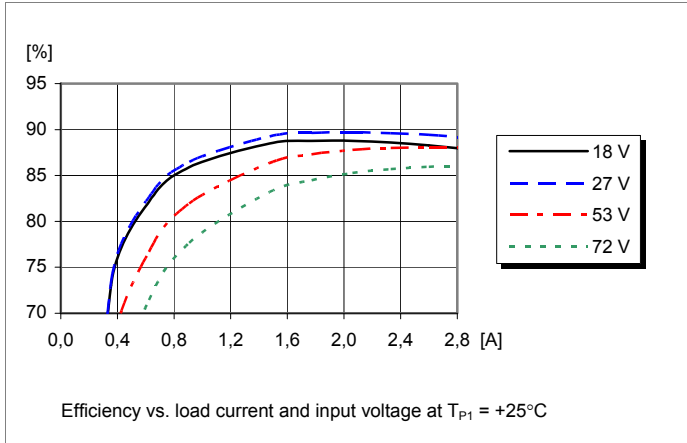

**Power Dissipation**

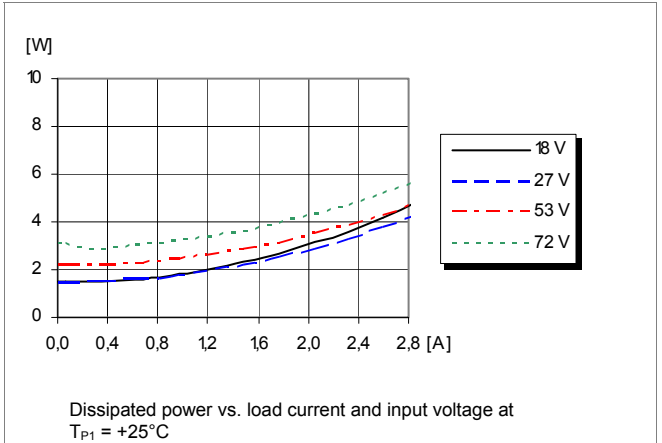

**Output Characteristics**

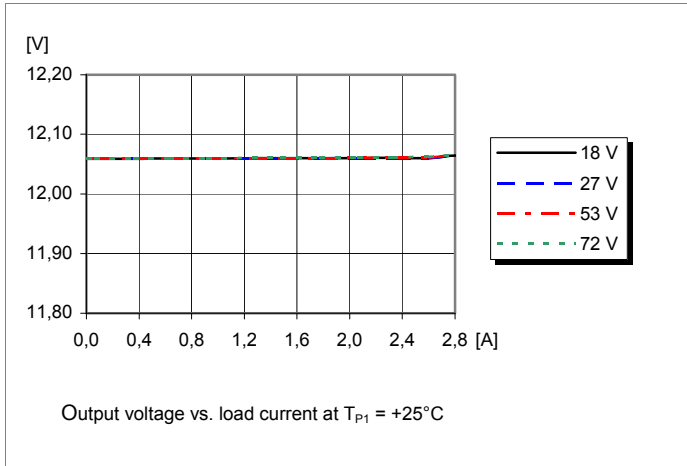

**Current Limit Characteristics**

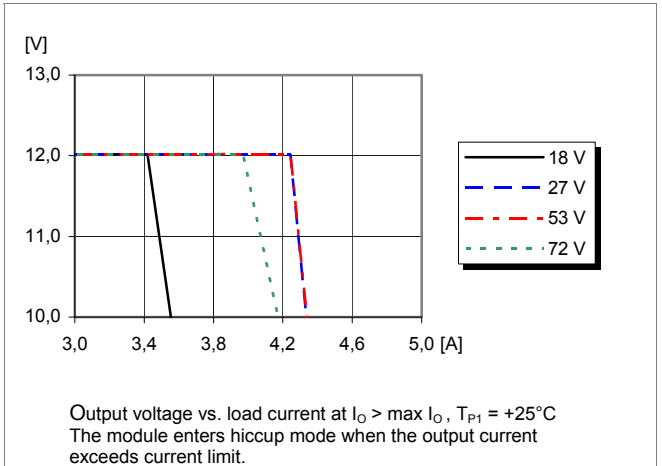

**Output Current Derating**

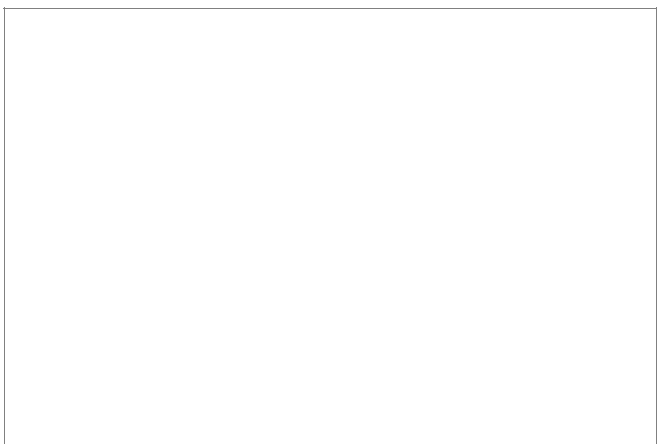
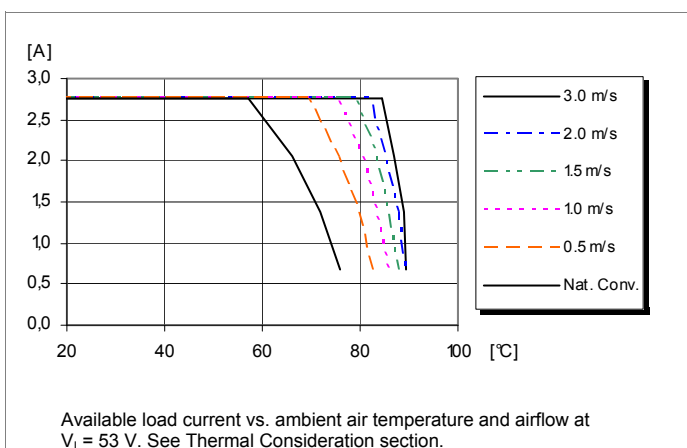

PKU 5000E series  
DC/DC converters, Input 18-72 V, Output up to 10 A/35 W

EN/LZT 146 391 R4B May 2009  
© Ericsson AB

**12 V/2.75 A Typical Characteristics**

**PKU 5313E PI**

**Start-up**

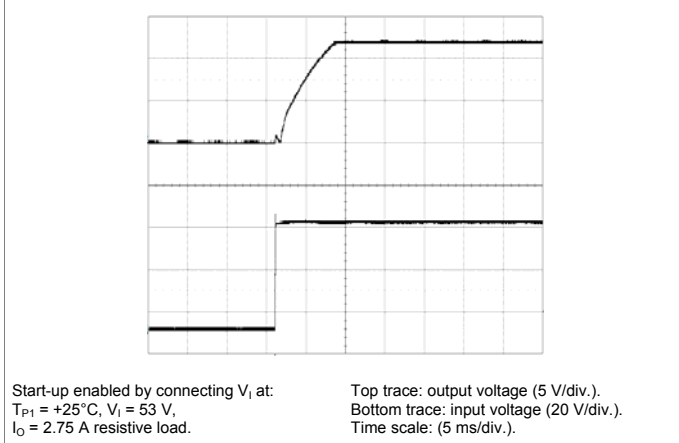

**Shut-down**

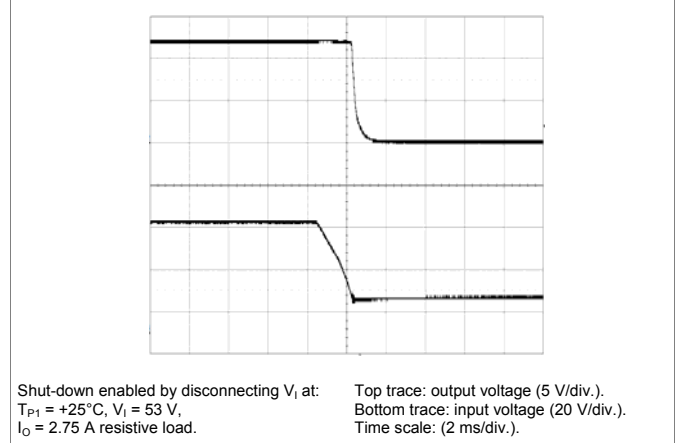

**Output Ripple & Noise**

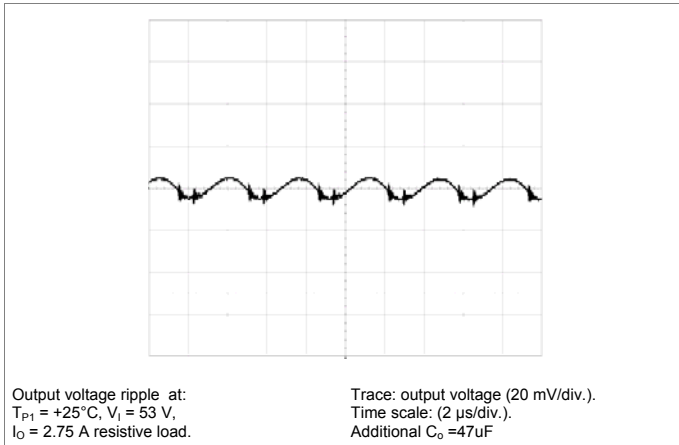

**Output Load Transient Response**

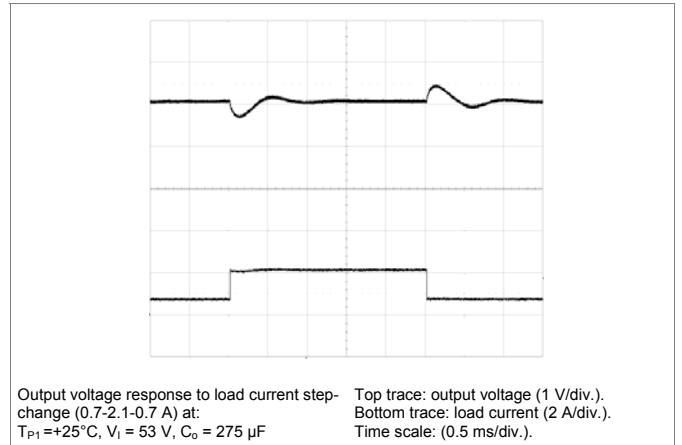

**Output Voltage Adjust (see operating information)**

**Passive adjust**

The resistor value for an adjusted output voltage is calculated by using the following equations:

Output Voltage Adjust Upwards, Increase:

$$R_{adj} = \left( \frac{5.11 \times 12.0 (100 + \Delta\%)}{1.225 \times \Delta\%} - \frac{511}{\Delta\%} - 10.22 \right) \text{ k}\Omega$$

Example: Increase 4% =>  $V_{out} = 12.48\text{ Vdc}$

$$\left( \frac{5.11 \times 12.0 (100 + 4)}{1.225 \times 4} - \frac{511}{4} - 10.22 \right) \text{ k}\Omega = 1174\text{ k}\Omega$$

**Active adjust**

The output voltage may be adjusted using a voltage applied to the  $V_{adj}$  pin. This voltage is calculated by using the following equations:

$$V_{adj} = \left( 1.225 + 2.45 \times \frac{V_{desired} - 12.0}{12.0} \right) \text{ V}$$

Example: Upwards => 12.48 V

$$\left( 1.225 + 2.45 \times \frac{12.48 - 12.0}{12.0} \right) \text{ V} = 1.323\text{ V}$$

PKU 5000E series  
 DC/DC converters, Input 18-72 V, Output up to 10 A/35 W

EN/LZT 146 391 R4B May 2009

© Ericsson AB

**15 V/2 A Electrical Specification**
**PKU 5315E PI**
 $T_{P1} = -30$  to  $+90^{\circ}\text{C}$ ,  $V_1 = 18$  to  $72$  V, unless otherwise specified under Conditions.

 Typical values given at:  $T_{P1} = +25^{\circ}\text{C}$ ,  $V_1 = 53$  V,  $I_O = \text{max } I_O$ , unless otherwise specified under Conditions.

 Additional  $C_O = 47$   $\mu\text{F}$ .

Characteristics		Conditions	min	typ	max	Unit
$V_1$	Input voltage range		18		72	V
$V_{\text{loff}}$	Turn-off input voltage	Decreasing input voltage	15	16	17	V
$V_{\text{lon}}$	Turn-on input voltage	Increasing input voltage	16	17	18	V
$C_1$	Internal input capacitance			4.4		$\mu\text{F}$
$P_O$	Output power	Output voltage initial setting	0		30	W
$\eta$	Efficiency	50 % of max $I_O$ , $V_1 = 27$ V		85.6		%
		max $I_O$ , $V_1 = 27$ V		89.0		
		50 % of max $I_O$ , $V_1 = 53$ V		80.9		
		max $I_O$ , $V_1 = 53$ V		86.7		
$P_d$	Power Dissipation	max $I_O$		4.6	8	W
$P_{\text{li}}$	Input idling power	$I_O = 0$ A, $V_1 = 53$ V		3.2		W
$P_{\text{RC}}$	Input standby power	$V_1 = 53$ V (turned off with RC)		0.4		W
$f_s$	Switching frequency	0-100 % of max $I_O$	280	315	350	kHz

$V_{O1}$	Output voltage initial setting and accuracy	$T_{P1} = +25^{\circ}\text{C}$ , $V_1 = 53$ V, $I_O = 2$ A	14.70	15.0	15.30	V
$V_O$	Output adjust range	See operating information, Note 1	13.5		16.5	V
	Output voltage tolerance band	10-100 % of max $I_O$	14.70		15.30	V
	Idling voltage	$I_O = 0$ A	14.70		15.30	V
	Line regulation	max $I_O$		$\pm 50$	$\pm 100$	mV
	Load regulation	$V_1 = 53$ V, 0-100 % of max $I_O$		$\pm 50$	$\pm 100$	mV
$V_{\text{tr}}$	Load transient voltage deviation	$V_1 = 53$ V, Load step 25-75-25 % of max $I_O$ , $di/dt = 5$ A/ $\mu\text{s}$ , $C_O = 200$ $\mu\text{F}$		$\pm 300$	$\pm 500$	mV
$t_{\text{tr}}$	Load transient recovery time			150	250	$\mu\text{s}$
$t_r$	Ramp-up time (from 10-90 % of $V_{O1}$ )	10-100 % of max $I_O$		5		ms
$t_s$	Start-up time (from $V_1$ connection to 90 % of $V_{O1}$ )			6		ms
$t_f$	$V_1$ shut-down fall time (from $V_1$ off to 10 % of $V_O$ )	max $I_O$	1	3		ms
		$I_O = 0$ A		1		s
$t_{\text{RC}}$	RC start-up time	max $I_O$		28		ms
	RC shut-down fall time (from RC off to 10 % of $V_O$ )	max $I_O$	1	2		ms
		$I_O = 0$ A		0.5		s
$I_O$	Output current		0		2	A
$I_{\text{lim}}$	Current limit threshold	$V_1 = 53$ V, $T_{P1} < \text{max } T_{P1}$		3.2	5	A
$I_{\text{sc}}$	Short circuit current	$T_{P1} = 25^{\circ}\text{C}$ , Note 2		6		A
$V_{\text{Oac}}$	Output ripple & noise	See ripple & noise section, max $I_O$ , $V_{O1}$ , $C_O = 47$ $\mu\text{F}$		25	50	mVp-p
OVP	Over voltage protection	$T_{P1} = +25^{\circ}\text{C}$ , $V_1 = 53$ V, 0-100 % of max $I_O$		19		V

 1)  $V_1$  min 24 V to obtain 16.5 V at 30 W output power.

2) RMS value

PKU 5000E series  
DC/DC converters, Input 18-72 V, Output up to 10 A/35 W

EN/LZT 146 391 R4B May 2009  
© Ericsson AB

**15 V/2 A Typical Characteristics**

**PKU 5315E PI**

**Efficiency**

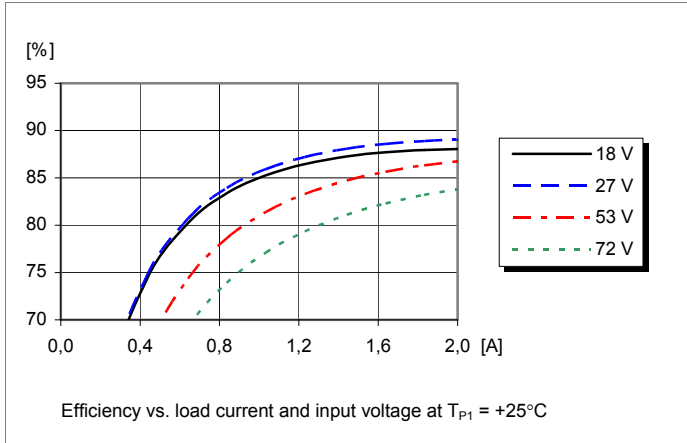

**Power Dissipation**

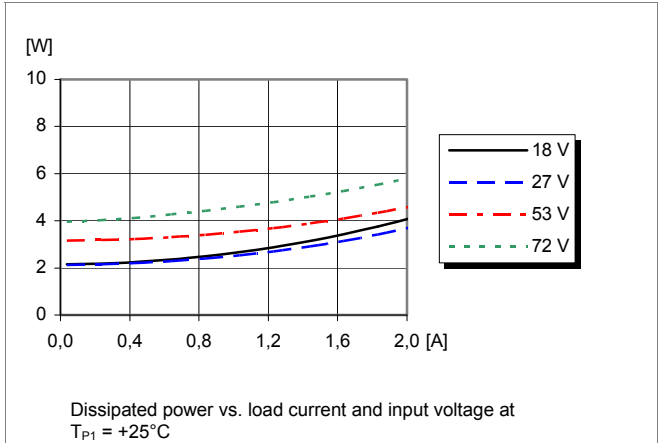

**Output Characteristics**

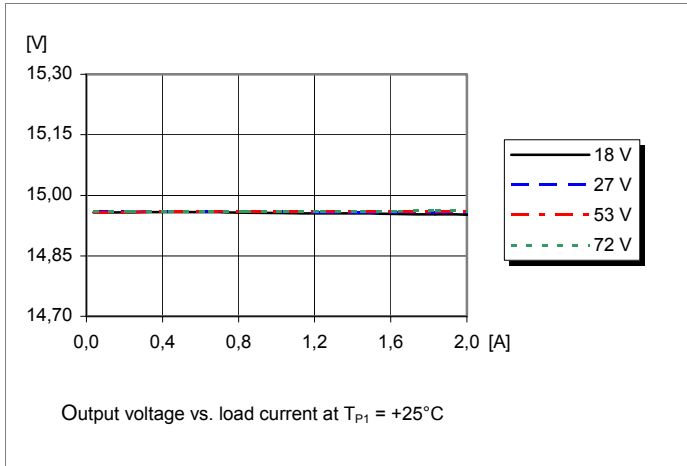

**Current Limit Characteristics**

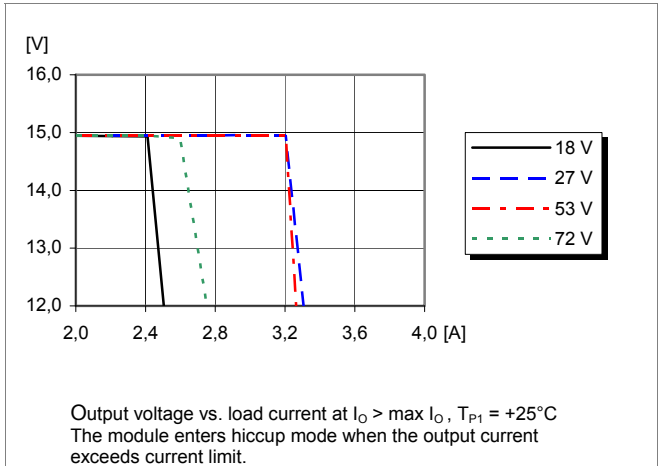

**Output Current Derating**

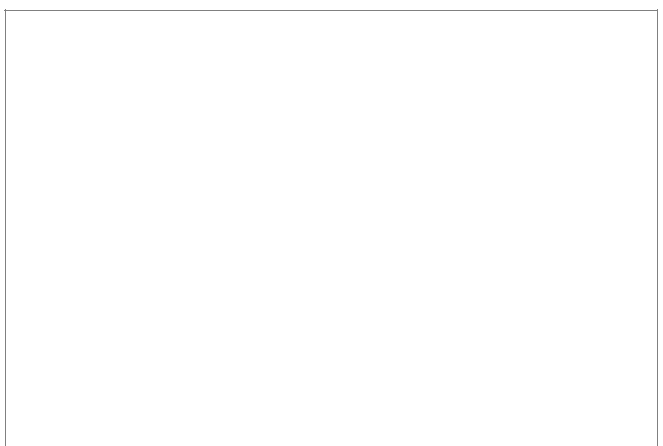
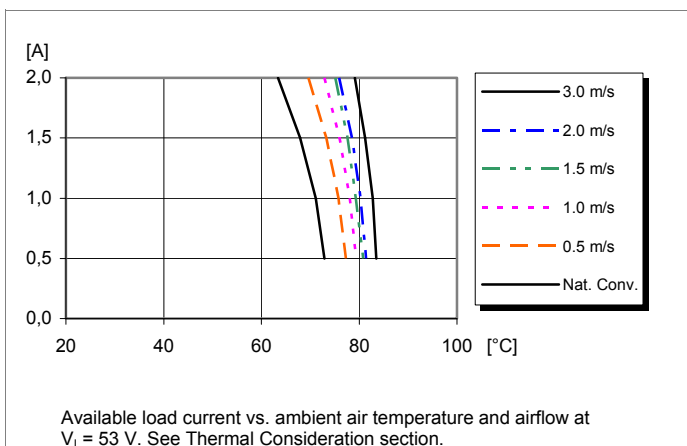

PKU 5000E series  
DC/DC converters, Input 18-72 V, Output up to 10 A/35 W

EN/LZT 146 391 R4B May 2009  
© Ericsson AB

**15 V/2 A Typical Characteristics**

**PKU 5315E PI**

**Start-up**

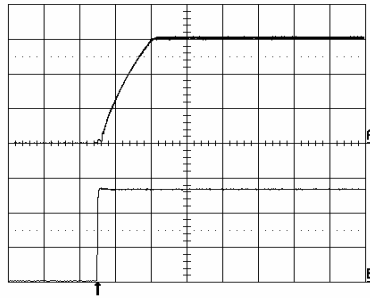

Start-up enabled by connecting  $V_1$  at:  
 $T_{P1} = +25^\circ\text{C}$ ,  $V_1 = 53\text{ V}$ ,  
 $I_O = 2\text{ A}$  resistive load.  
Top trace: output voltage (5 V/div.).  
Bottom trace: input voltage (20 V/div.).  
Time scale: (5 ms/div.).

**Shut-down**

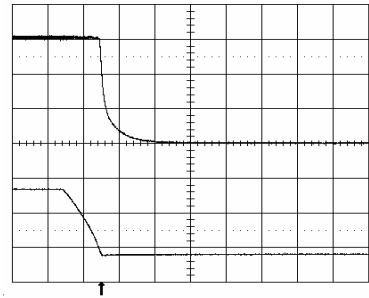

Shut-down enabled by disconnecting  $V_1$  at:  
 $T_{P1} = +25^\circ\text{C}$ ,  $V_1 = 53\text{ V}$ ,  
 $I_O = 2\text{ A}$  resistive load.  
Top trace: output voltage (5 V/div.).  
Bottom trace: input voltage (20 V/div.).  
Time scale: (2 ms/div.).

**Output Ripple & Noise**

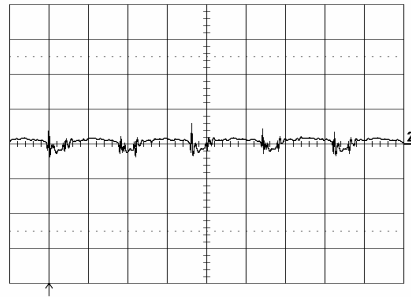

Output voltage ripple at:  
 $T_{P1} = +25^\circ\text{C}$ ,  $V_1 = 53\text{ V}$ ,  
 $I_O = 2\text{ A}$  resistive load.  
Trace: output voltage (20 mV/div.).  
Time scale: (2  $\mu\text{s}$ /div.).  
Additional  $C_o = 47\mu\text{F}$

**Output Load Transient Response**

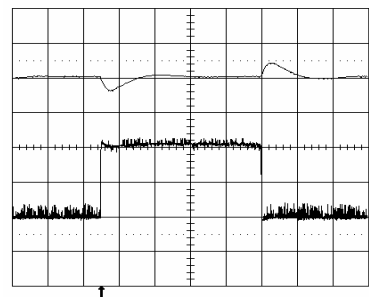

Output voltage response to load current step-change (0.5-1.5-0.5 A) at:  
 $T_{P1} = +25^\circ\text{C}$ ,  $V_1 = 53\text{ V}$ ,  $C_o = 200\mu\text{F}$   
Top trace: output voltage (1 V/div.).  
Bottom trace: load current (0.5 A/div.).  
Time scale: (0.1 ms/div.).

**Output Voltage Adjust (see operating information)**

**Passive adjust**

The resistor value for an adjusted output voltage is calculated by using the following equations:

Output Voltage Adjust Upwards, Increase:

$$R_{adj} = \left( \frac{5.11 \times 15.0 (100 + \Delta\%)}{1.225 \times \Delta\%} - \frac{511}{\Delta\%} - 10.22 \right) \text{ k}\Omega$$

Example: Increase 4% =>  $V_{out} = 15.6\text{ Vdc}$

$$\left( \frac{5.11 \times 15.0 (100 + 4)}{1.225 \times 4} - \frac{511}{4} - 10.22 \right) \text{ k}\Omega = 1489 \text{ k}\Omega$$

**Active adjust**

The output voltage may be adjusted using a voltage applied to the  $V_{adj}$  pin. This voltage is calculated by using the following equations:

$$V_{adj} = \left( 1.225 + 2.45 \times \frac{V_{desired} - 15.0}{15.0} \right) \text{ V}$$

Example: Upwards => 15.6 V

$$\left( 1.225 + 2.45 \times \frac{15.6 - 15.0}{15.0} \right) \text{ V} = 1.323 \text{ V}$$



PKU 5000E series  
DC/DC converters, Input 18-72 V, Output up to 10 A/35 W

EN/LZT 146 391 R4B May 2009

© Ericsson AB

**EMC Specification**

Conducted EMI measured according to EN55022, CISPR 22 and FCC part 15J (see test set-up). See Design Note 009 for further information. The fundamental switching frequency is 285 kHz for PKU 5310E PI, PKU 5311E PI, and PKU 5313E PI. For PKU 5315E PI it is 315 kHz.

**Conducted EMI Input terminal value (typ)**

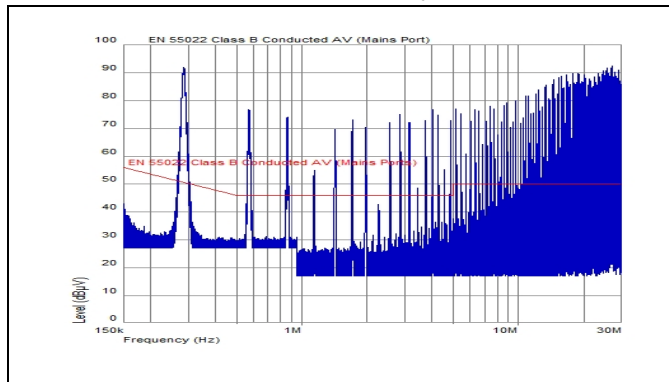

EMI without filter @  $V_I = 53 V, max I_O$ .

**External filter (class B)**

Required external input filter in order to meet class B in EN 55022, CISPR 22 and FCC part 15J.

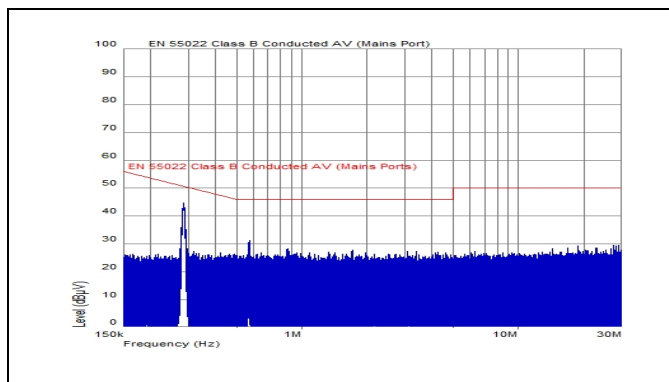
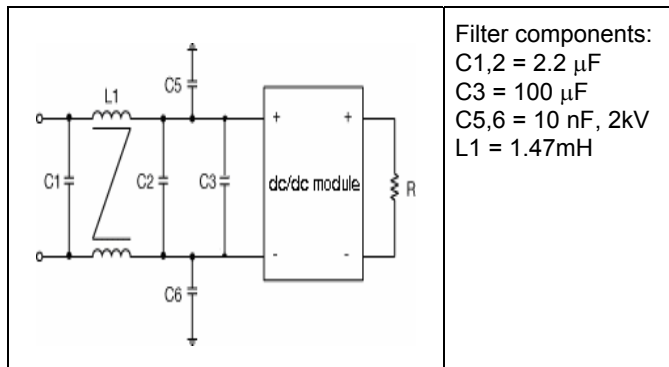

EMI with filter @  $V_I = 53 V, max I_O$ .

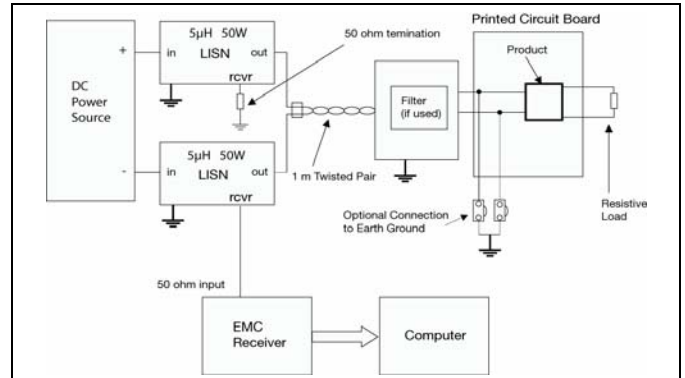

Test set-up

**Layout recommendations**

The radiated EMI performance of the Product will depend on the PCB layout and ground layer design. It is also important to consider the stand-off of the product. If a ground layer is used, it should be connected to the output of the product and the equipment ground or chassis.

A ground layer will increase the stray capacitance in the PCB and improve the high frequency EMC performance.

**Output ripple and noise**

Output ripple and noise measured according to figure below. See Design Note 022 for detailed information.

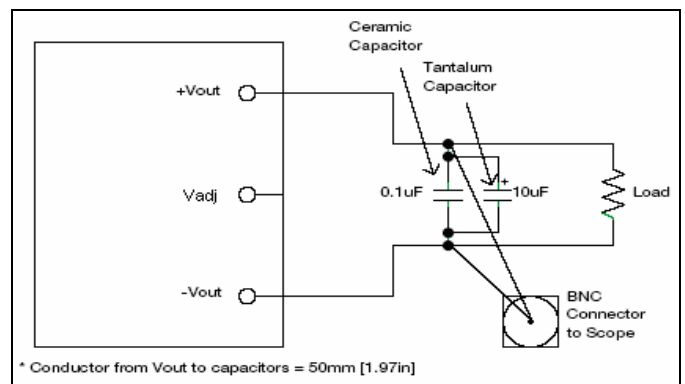

Output ripple and noise test setup

PKU 5000E series DC/DC converters, Input 18-72 V, Output up to 10 A/35 W	EN/LZT 146 391 R4B May 2009
	© Ericsson AB

**Operating information**

**Input Voltage**

The input voltage range 18 to 72Vdc meets the requirements of the European Telecom Standard ETS 300 132-2 for normal input voltage range in -48 and -60 Vdc systems, -40.5 to -57.0 V and -50.0 to -72 V respectively.

At input voltages exceeding 72 V, the power loss will be higher than at normal input voltage. Precaution must be taken to keep  $T_{P1}$  below +95°C. The absolute maximum continuous input voltage is 80 Vdc.

**Turn-off Input Voltage**

The products monitor the input voltage and will turn on and turn off at predetermined levels. The minimum hysteresis between turn on and turn off input voltage is 1V. The input voltage supply must have low impedance to prevent the risk of input oscillation, poor supply can also cause shutdown-bouncing.

**Remote Control (RC)**

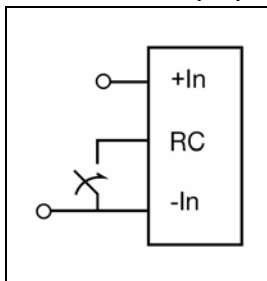

The products are fitted with a remote control function referenced to the primary negative input connection (-In), with negative and positive logic options available. The RC function allows the product to be turned on/off by an external device like a semiconductor or mechanical switch. The RC pin has an internal pull up resistor to +In.

The maximum required sink current is 1 mA. When the RC pin is left open, the voltage generated on the RC pin is 4.5 – 5.5 V.

The standard product is provided with “negative logic” remote control and will be off until the RC pin is connected to the -In. To turn on the product the voltage between RC pin and -In should be less than 1V.

To turn off the converter the RC pin should be left open, or connected to a voltage higher than 4 V referenced to -In. In situations where it is desired to have the product to power up automatically without the need for control signals or a switch, the RC pin can be wired directly to -In.

The second option is “positive logic” remote control, which can be ordered by adding the suffix “P” to the end of the part number.

When the RC pin is left open, the product starts up automatically when the input voltage is applied. Turn off is achieved by connecting the RC pin to the -In. To ensure safe turn off the voltage difference between RC pin and the -In pin shall be less than 1V. The product will restart automatically when this connection is opened.

See Design Note 021 for detailed information.

**Input and Output Impedance**

The impedance of both the input source and the load will interact with the impedance of the DC/DC converter. It is important that the input source has low characteristic impedance.

The performance in some applications can be enhanced by addition of external capacitance as described in External Decoupling Capacitors.

If the input voltage source contains significant inductance, the addition of a low ESR 47 µF capacitor across the input of the converter will ensure stable operation in all conditions.

**External Decoupling Capacitors**

The products have been designed to operate with a minimum capacitance connected to their output.

When powering loads with significant dynamic current requirements, the voltage regulation at the point of load can be improved by addition of decoupling capacitors at the load. The most effective technique is to locate low ESR ceramic and electrolytic capacitors as close to the load as possible, using several parallel capacitors to lower the effective ESR. The ceramic capacitors will handle high-frequency dynamic load changes while the electrolytic capacitors are used to handle low frequency dynamic load changes. Ceramic capacitors will also reduce any high frequency noise at the load.

It is equally important to use low resistance and low inductance PCB layouts and cabling. If significant inductance are within the load distribution, >50% of the stated “Minimum Output Capacitance” shall be located at the module’s output.

External decoupling capacitors will become part of the control loop of the DC/DC converter and may affect the stability margins. As a “rule of thumb”, 100 µF/A of output current can be added without any additional analysis. The ESR of the capacitors is a very important parameter. Ericsson Power Modules guarantee stable operation with a verified ESR value of >10 mΩ across the output connections.

	Minimum Input Capacitance	Minimum Output Capacitance
PKU 5310E PI	47µF	220µF
PKU 5311E PI	47µF	150µF
PKU 5313E PI	47µF	47µF
PKU 5315E PI	47µF	47µF

Minimum capacitance

For further information please contact your local Ericsson Power Modules representative.

PKU 5000E series DC/DC converters, Input 18-72 V, Output up to 10 A/35 W	EN/LZT 146 391 R4B May 2009 © Ericsson AB
-----------------------------------------------------------------------------	----------------------------------------------

**Operating information continued**

**Output Voltage Adjust ( $V_{adj}$ )**

The products have an Output Voltage Adjust pin ( $V_{adj}$ ). This pin can be used to adjust the output voltage above or below Output voltage initial setting.

When increasing the output voltage, the voltage at the output pins must be kept below the threshold of the over voltage protection, (OVP) to prevent the product from entering OVP. At increased output voltages the maximum power rating of the product remains the same, and the max output current must be decreased correspondingly.

To increase the voltage the resistor should be connected between the  $V_{adj}$  pin and +Out pin. The resistor value of the Output voltage adjust function is according to information given under the Output section for the respective product.

To decrease the output voltage, the resistor should be connected between the  $V_{adj}$  pin and -Out pin.

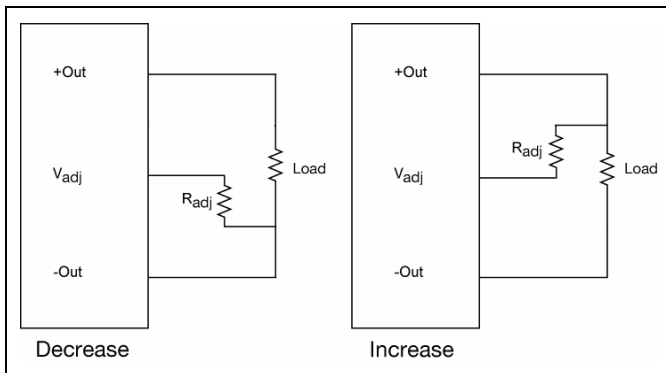

**Over Temperature Protection (OTP)**

The converters are protected from thermal overload by an internal over temperature shutdown circuit.

When  $T_{P1}$  as defined in thermal consideration section reach exceeds 105°C the converter will shut down.

The DC/DC converter will make continuous attempts to start up (non-latching mode) and resume normal operation automatically when the hot-spot temperature has dropped 10°C below the temperature threshold.

**Over Voltage Protection (OVP)**

The converters have output over voltage protection that will prevent output voltage to exceed the specified value in technical specification.

The converter will limit the outputvoltage to the maximum level. Converters will resume normal operation automatically after removal of the over voltage condition.

**Over Current Protection (OCP)**

The converters include current limiting circuitry for protection at continuous overload.

The output voltage will decrease towards zero for output currents in excess of max output current (max  $I_o$ ).

After a time period exceeding 10 ms in OCP converters will enter hiccupmode to reduce average output power.

During short-circuit condition module temperature will increase rapidly and OTP function may be activated.

Module will not resume from hiccup shutdown period unless the temperature drops below the OTP re-activation temperature.

The converter will resume normal operation after removal of the overload. The load distribution should be designed for the maximum output short circuit current specified.

**Pre-bias Start-up**

The product has a Pre-bias start up functionality and will not sink current during start up or RC-off if a pre-bias source with less than 75% of  $V_o$  is present at the output terminals.

Precaution must be taken that reverse current might be present if  $V_i$  is disabled. Without  $V_i$  a small current will discharge external capacitors.

NB! Feeding  $V_o$  from external power supply for test purpose might without  $V_i$  cause high reverse current.

PKU 5000E series  
DC/DC converters, Input 18-72 V, Output up to 10 A/35 W

EN/LZT 146 391 R4B May 2009  
© Ericsson AB

**Thermal Consideration**

**General**

The products are designed to operate in different thermal environments and sufficient cooling must be provided to ensure reliable operation.

For products mounted on a PCB without a heat sink attached, cooling is achieved mainly by conduction, from the pins to the host board, and convection, which is dependant on the airflow across the product. Increased airflow enhances the cooling of the product. The Output Current Derating graph found in the Output section for each model provides the available output current vs. ambient air temperature and air velocity at  $V_I = 53$  V.

The product is tested on a 254 x 254 mm, 35  $\mu$ m (1 oz), 8-layer test board mounted vertically in a wind tunnel with a cross-section of 608 x 203 mm.

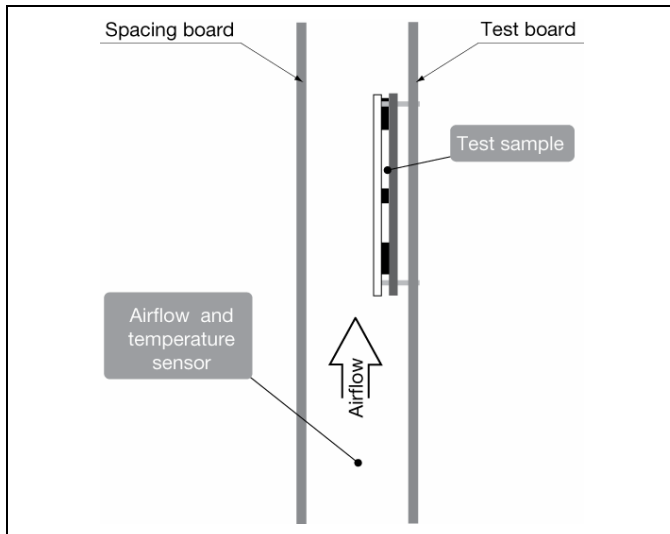

Proper cooling of the product can be verified by measuring the temperature at position P1. The temperature at this position should not exceed the max values provided in the table below. The number of points may vary with different thermal design and topology.

See Design Note 019 for further information.

Position	Description	Temp. limit
P1	Opto coupler	95° C

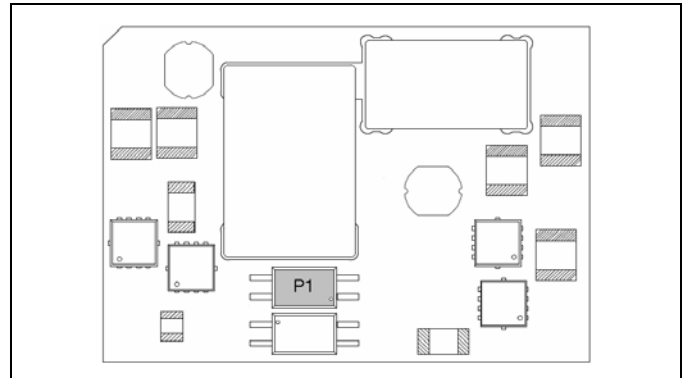

Open frame

**Definition of reference temperature  $T_{P1}$**

The reference temperature is used to monitor the temperature limits of the product. Temperatures above maximum  $T_{P1}$ , measured at the reference point P1 are not allowed and may cause degradation or permanent damage to the product.  $T_{P1}$  is also used to define the temperature range for normal operating conditions.  $T_{P1}$  is defined by the design and used to guarantee safety margins, proper operation and high reliability of the product.

**Connections**

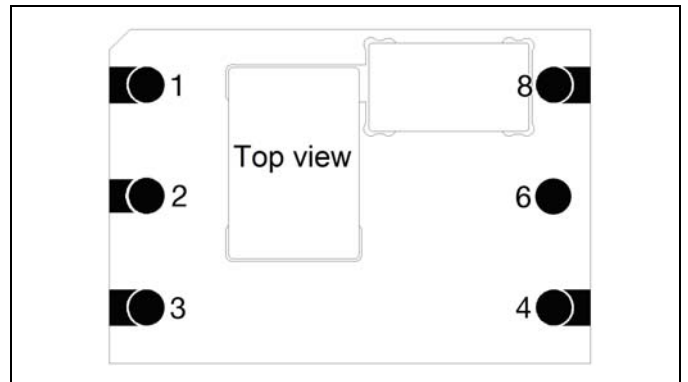

Pin	Designation	Function
1	+In	Positive Input
2	RC	Remote control
3	-In	Negative Input
4	-Out	Negative Output
6	Vadj	Output voltage adjust
8	+Out	Positive Output

PKU 5000E series  
DC/DC converters, Input 18-72 V, Output up to 10 A/35 W

EN/LZT 146 391 R4B May 2009

© Ericsson AB

**Mechanical Information - Hole Mount, Open Frame Version**

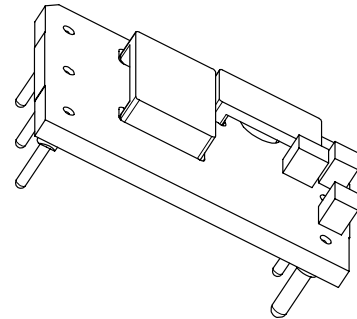
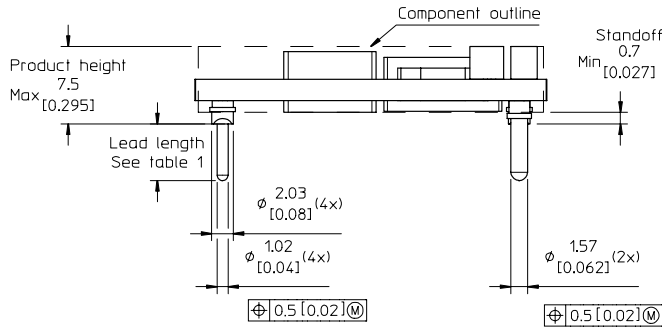

TOP VIEW

Pin positions according to the recommended footprint.

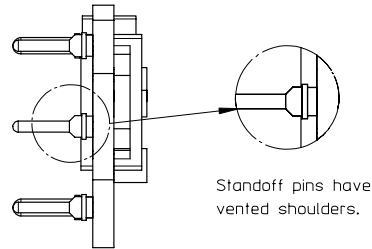
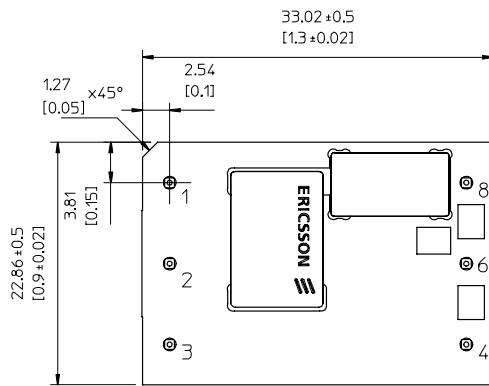

RECOMMENDED FOOTPRINT - TOP VIEW

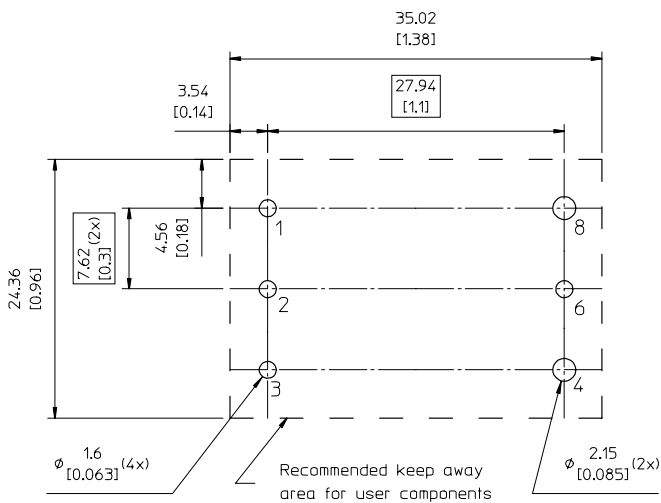

Table 1

Pin option	Lead length
Standard	5.33 [0.21]
LA	3.69 [0.145] (cut)
LB	4.57 [0.18] (cut)

Pins:  
Material: Copper alloy  
Plating: Min 0.1  $\mu$ m Gold over 1-3  $\mu$ m Nickel.

Weight: typical 10 g

All dimensions in mm [inch].  
Tolerances unless specified

X.x mm ±0.5 mm [0.02]

X.xx mm ±0.25 mm [0.01]

(not applied on footprint or typical values)



PKU 5000E series  
DC/DC converters, Input 18-72 V, Output up to 10 A/35 W

EN/LZT 146 391 R4B May 2009

© Ericsson AB

**Mechanical Information - Surface Mount Version**

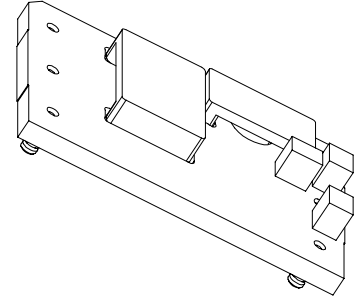
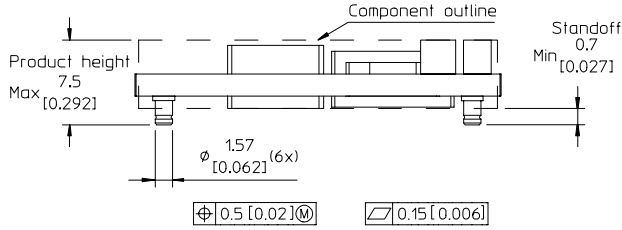

TOP VIEW

Pin positions according to the recommended footprint

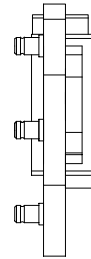
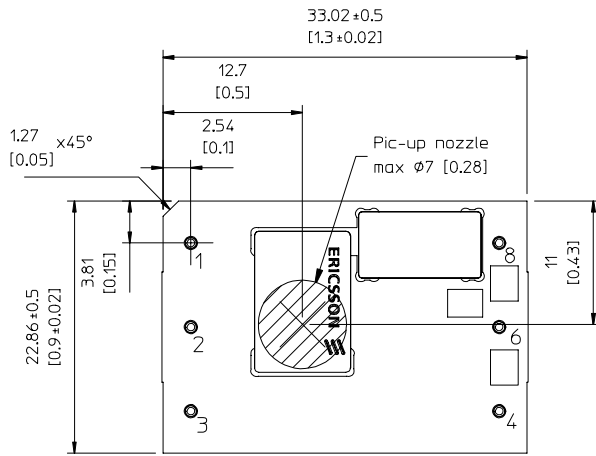

RECOMMENDED FOOTPRINT - TOP VIEW

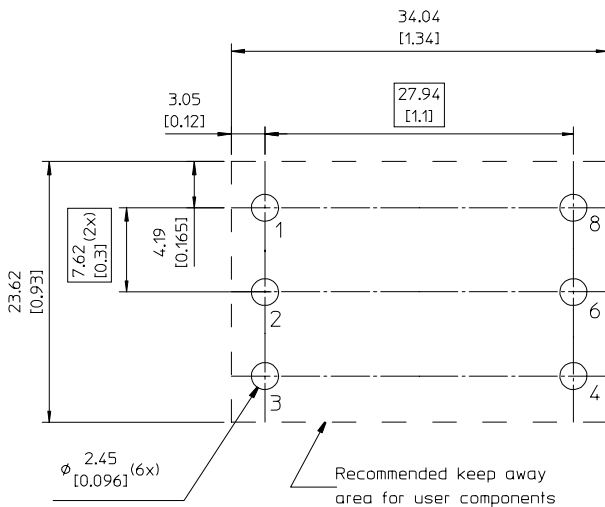

Layout considerations:

Use sufficient numbers of vias connected to output pin pads for proper thermal and current conductivity.

Pins:

Material: Copper alloy  
Plating: Min 0.1  $\mu$ m Gold over 1-3  $\mu$ m Nickel.

Weight: typical 10 g

All dimensions in mm [inch].  
Tolerances unless specified

X.x mm ± 0.5 mm [0.02]

X.xx mm ± 0.25 mm [0.01]

(not applied on footprint or typical values)



PKU 5000E series  
DC/DC converters, Input 18-72 V, Output up to 10 A/35 W

EN/LZT 146 391 R4B May 2009

© Ericsson AB

**Soldering Information - Surface Mounting**

The surface mount product is intended for forced convection or vapor phase reflow soldering in SnPb or Pb-free processes.

The reflow profile should be optimised to avoid excessive heating of the product. It is recommended to have a sufficiently extended preheat time to ensure an even temperature across the host PCB and it is also recommended to minimize the time in reflow.

A no-clean flux is recommended to avoid entrapment of cleaning fluids in cavities inside the product or between the product and the host board, since cleaning residues may affect long time reliability and isolation voltage.

**Minimum Pin Temperature Recommendations**

Pin number 8 is chosen as reference location for the minimum pin temperature recommendation since this will likely be the coolest solder joint during the reflow process.

**SnPb solder processes**

For SnPb solder processes, a pin temperature ( $T_{PIN}$ ) in excess of the solder melting temperature, ( $T_L$ , 183°C for Sn63Pb37) for more than 30 seconds and a peak temperature of 210°C is recommended to ensure a reliable solder joint.

**Lead-free (Pb-free) solder processes**

For Pb-free solder processes, a pin temperature ( $T_{PIN}$ ) in excess of the solder melting temperature ( $T_L$ , 217 to 221°C for SnAgCu solder alloys) for more than 30 seconds and a peak temperature of 235°C on all solder joints is recommended to ensure a reliable solder joint.

General reflow process specifications		SnPb eutectic	Pb-free
Average ramp-up ( $T_{PRODUCT}$ )		3°C/s max	3°C/s max
Typical solder melting (liquidus) temperature	$T_L$	183°C	221°C
Minimum reflow time above $T_L$		30 s	30 s
Minimum pin temperature	$T_{PIN}$	210°C	235°C
Max product temperature	$T_{PRODUCT}$	225°C	260°C
Average ramp-down ( $T_{PRODUCT}$ )		6°C/s max	6°C/s max
Maximum time 25°C to peak		6 minutes	8 minutes

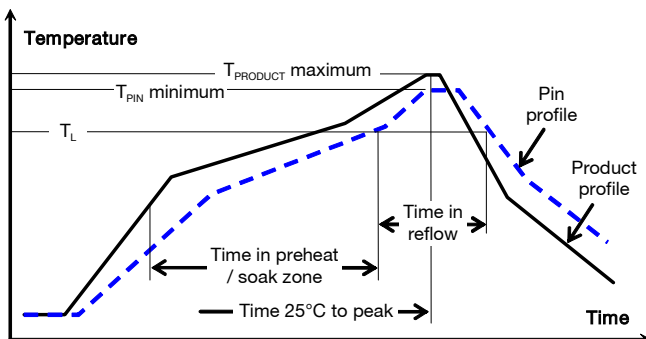

**Maximum Product Temperature Requirements**

Top of the product PCB near pin 2 is chosen as reference location for the maximum (peak) allowed product temperature ( $T_{PRODUCT}$ ) since this will likely be the warmest part of the product during the reflow process.

**SnPb solder processes**

For SnPb solder processes, the product is qualified for MSL 1 according to IPC/JEDEC standard J-STD-020C.

During reflow  $T_{PRODUCT}$  must not exceed 225 °C at any time.

**Pb-free solder processes**

For Pb-free solder processes, the product is qualified for MSL 3 according to IPC/JEDEC standard J-STD-020C.

During reflow  $T_{PRODUCT}$  must not exceed 260 °C at any time.

**Dry Pack Information**

Products intended for Pb-free reflow soldering processes are delivered in standard moisture barrier bags according to IPC/JEDEC standard J-STD-033 (Handling, packing, shipping and use of moisture/reflow sensitivity surface mount devices).

Using products in high temperature Pb-free soldering processes requires dry pack storage and handling. In case the products have been stored in an uncontrolled environment and no longer can be considered dry, the modules must be baked according to J-STD-033.

**Thermocoupler Attachment**

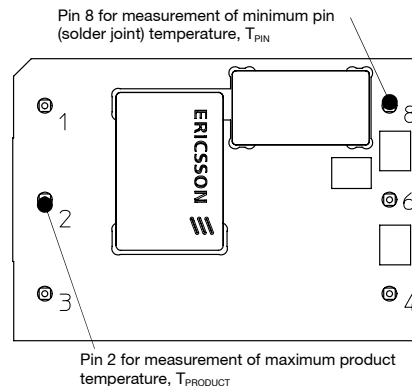



PKU 5000E series  
DC/DC converters, Input 18-72 V, Output up to 10 A/35 W

EN/LZT 146 391 R4B May 2009  
© Ericsson AB

**Soldering Information - Hole Mounting**

The hole mounted product is intended for plated through hole mounting by wave or manual soldering. The pin temperature is specified to maximum to 270°C for maximum 10 seconds.

A maximum preheat rate of 4°C/s and maximum preheat temperature of 150°C is suggested. When soldering by hand, care should be taken to avoid direct contact between the hot soldering iron tip and the pins for more than a few seconds in order to prevent overheating.

A no-clean flux is recommended to avoid entrapment of cleaning fluids in cavities inside the product or between the product and the host board. The cleaning residues may affect long time reliability and isolation voltage.

**Delivery Package Information**

The surface mount products are delivered in antistatic injection molded trays (Jedec design guide 4.10D standard) and in antistatic carrier tape (EIA 481 standard). The through-hole mount products are delivered in antistatic injection molded trays (Jedec design guide 4.10D standard).

Tray Specifications	
<b>Material</b>	Antistatic PPE
<b>Surface resistance</b>	$10^5 < \text{Ohm/square} < 10^{12}$
<b>Bakability</b>	The trays can be baked at maximum 125°C for 48 hours
<b>Tray thickness</b>	18.5 mm [0.728 inch]
<b>Tray capacity</b>	30 products/tray
<b>Tray weight</b>	190 g empty, 500 g full tray

Carrier Tape Specifications	
<b>Material</b>	Antistatic PS
<b>Surface resistance</b>	$10^7 < \text{Ohm/square}$
<b>Bakeability</b>	The tape is not bakable
<b>Tape width, W</b>	56 mm [2.2 inch]
<b>Pocket pitch, P<sub>1</sub></b>	36 mm [1.42 inch]
<b>Pocket depth, K<sub>0</sub></b>	8.7 mm [0.343 inch]
<b>Reel diameter</b>	380 mm [15 inch]
<b>Reel capacity</b>	200 products /reel
<b>Reel weight</b>	2.3 kg/full reel

EIA standard carrier tape

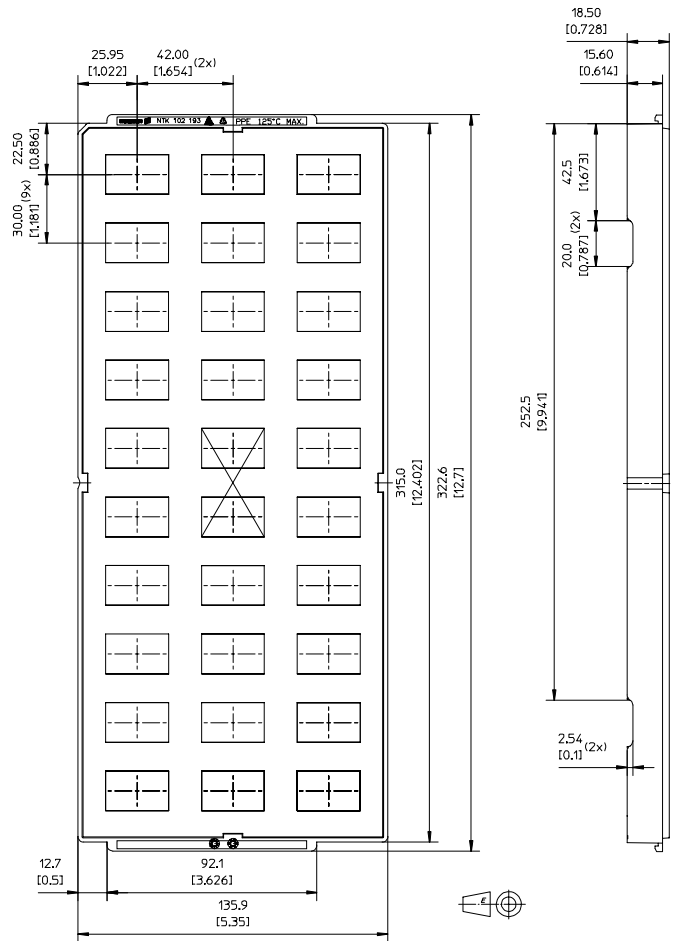
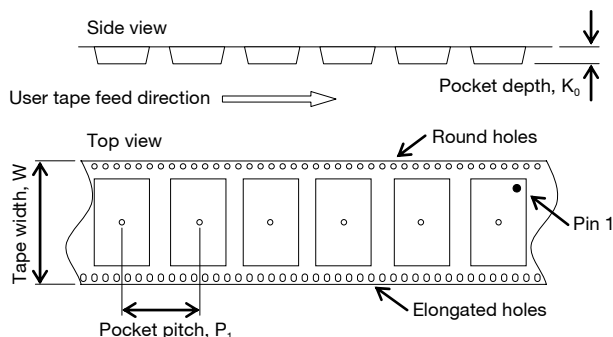

X = Vacuum pick up  
All dimensions in mm [inch]  
Tolerances: X.xx mm ±0.13 mm [0.005], X.x mm ±0.26 mm [0.01]  
Note: tray dimensions refer to pocket center. For exact location of product pick up surface, refer to mechanical drawing.



PKU 5000E series DC/DC converters, Input 18-72 V, Output up to 10 A/35 W	EN/LZT 146 391 R4B May 2009
	© Ericsson AB

**Product Qualification Specification**

Characteristics			
External visual inspection	IPC-A-610		
Change of temperature (Temperature cycling)	IEC 60068-2-14 Na	Temperature range Number of cycles Dwell/transfer time	-40 to 100°C 1000 15 min/0-1 min
Cold (in operation)	IEC 60068-2-1 Ad	Temperature T <sub>A</sub> Duration	-45°C 72 h
Damp heat	IEC 60068-2-67 Cy	Temperature Humidity Duration	85°C 85 % RH 1000 hours
Dry heat	IEC 60068-2-2 Bd	Temperature Duration	125°C 1000 h
Electrostatic discharge susceptibility	IEC 61340-3-1, JESD 22-A114 IEC 61340-3-2, JESD 22-A115	Human body model (HBM) Machine Model (MM)	Class 1C, 1000 V Class 3, 200 V
Immersion in cleaning solvents	IEC 60068-2-45 XA, method 2	Water Glycol ether Isopropyl alcohol	55°C 35°C 35°C
Mechanical shock	IEC 60068-2-27 Ea	Peak acceleration Duration	100 g 6 ms
Moisture reflow sensitivity <sup>1</sup>	J-STD-020C	Level 1 (SnPb-eutectic) Level 3 (Pb Free)	225°C 260°C
Operational life test	MIL-STD-202G, method 108A	Duration	1000 h
Resistance to soldering heat <sup>2</sup>	IEC 60068-2-20 Tb, method 1A	Solder temperature Duration	270°C 10-13 s
Robustness of terminations	IEC 60068-2-21 Test Ua1 IEC 60068-2-21 Test Ue1	Through hole mount products Surface mount products	All leads All leads
Solderability	IEC 60068-2-58 test Td <sup>1</sup>	Preconditioning Temperature, SnPb Eutectic Temperature, Pb-free	150°C dry bake 16 h 215°C 235°C
	IEC 60068-2-20 test Ta <sup>2</sup>	Preconditioning Temperature, SnPb Eutectic Temperature, Pb-free	Steam ageing 235°C 245°C
Vibration, broad band random	IEC 60068-2-64 Fh, method 1	Frequency Spectral density Duration	10 to 500 Hz 0.07 g <sup>2</sup> /Hz 10 min in each direction

**Notes**
<sup>1</sup> Only for products intended for reflow soldering (surface mount products)

<sup>2</sup> Only for products intended for wave soldering (plated through hole products)