

TPD2E2U06-Q1 Automotive Dual-Channel High-Speed ESD Protection Device

1 Features

- AEC-Q101 Qualified
- IEC 61000-4-2 Level 4 ESD Protection
 - ± 25 -kV (Contact Discharge)
 - ± 30 -kV (Air-gap Discharge)
- ISO 10605 (330 pF, 330 Ω) ESD Protection
 - ± 20 -kV (Contact Discharge)
 - ± 25 -kV (Air-gap Discharge)
- IO Capacitance 1.5-pF (Typical)
- DC Breakdown Voltage 6.5 V (Minimum)
- Ultra-Low Leakage Current 10-nA (Maximum)
- Low ESD Clamping Voltage
- Industrial Temperature Range: -40°C to $+125^{\circ}\text{C}$
- Small Easy-to-Route DBZ and DCK Packages

2 Applications

- End Equipment
 - Head Units
 - Rear Seat Entertainment
 - Telematics
 - Navigation Modules
 - Media Interfaces
- Interfaces
 - USB 2.0
 - Ethernet
 - Antenna
 - LVDS
 - I²C

3 Description

The TPD2E2U06-Q1 is a Transient Voltage Suppressor (TVS) Electrostatic Discharge (ESD) protection diode array with low capacitance. This dual-channel ESD protection diode is rated to dissipate ESD strikes above the maximum level specified in the IEC 61000-4-2 international standard. The 1.5-pF line capacitance of the TPD2E2U06-Q1 makes it ideal for protecting interfaces such as USB 2.0, Ethernet, LVDS, Antenna, and I²C.

Device Information⁽¹⁾

PART NUMBER	PACKAGE	BODY SIZE (NOM)
TPD2E2U06-Q1	SOT23 (3)	2.92 mm x 1.30 mm
TPD2E2U06-Q1	SC70 (3)	2.00 mm x 1.25 mm

(1) For all available packages, see the orderable addendum at the end of the datasheet.

Simplified Schematic

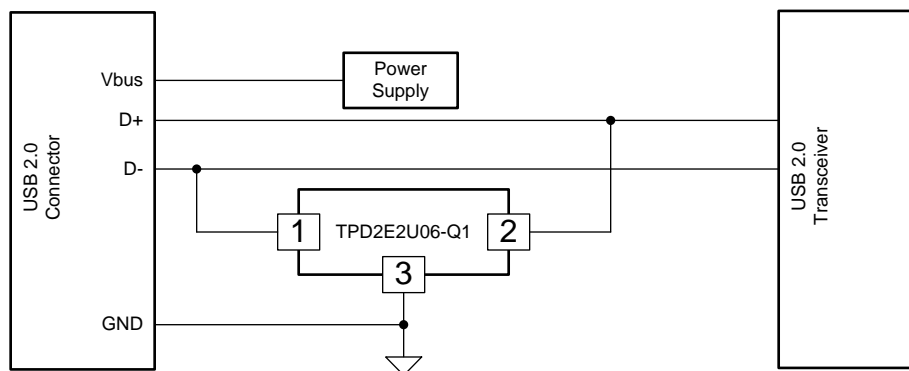

Copyright © 2016, Texas Instruments Incorporated



Table of Contents

1 Features	1	7.3 Feature Description	8
2 Applications	1	7.4 Device Functional Modes	9
3 Description	1	8 Application and Implementation	10
4 Revision History	2	8.1 Application Information	10
5 Pin Configuration and Functions	3	8.2 Typical Application	10
6 Specifications	4	9 Power Supply Recommendations	12
6.1 Absolute Maximum Ratings	4	10 Layout	12
6.2 ESD Ratings—AEC Specification	4	10.1 Layout Guidelines	12
6.3 ESD Ratings—IEC Specification	4	10.2 Layout Example	12
6.4 ESD Ratings—ISO Specification	4	11 Device and Documentation Support	13
6.5 Recommended Operating Conditions	4	11.1 Documentation Support	13
6.6 Thermal Information	4	11.2 Community Resources	13
6.7 Electrical Characteristics	5	11.3 Trademarks	13
6.8 Typical Characteristics	6	11.4 Electrostatic Discharge Caution	13
7 Detailed Description	8	11.5 Glossary	13
7.1 Overview	8	12 Mechanical, Packaging, and Orderable Information	13
7.2 Functional Block Diagram	8		

4 Revision History

NOTE: Page numbers for previous revisions may differ from page numbers in the current version.

Changes from Revision C (March 2016) to Revision D	Page
• Updated Features , Applications and Description	1
• Updated ESD Ratings—AEC Specification table	1

Changes from Revision B (December 2014) to Revision C	Page
• Added DCK package	1
• Added DCK thermal data in Thermal Information table	1

Changes from Revision A (December 2014) to Revision B	Page
• Added temperature specification to V_{BR} TEST CONDITIONS.	5

Changes from Original (December 2014) to Revision A	Page
• Initial release of full document.	1

5 Pin Configuration and Functions

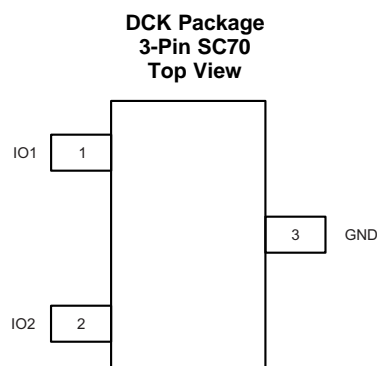
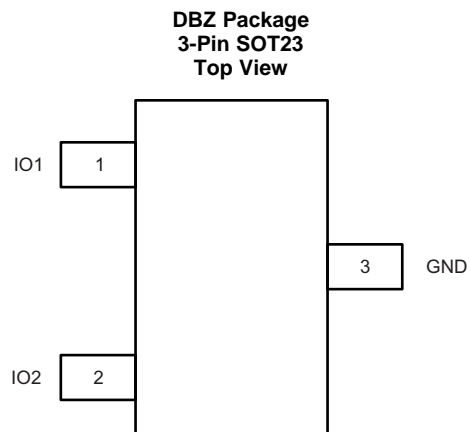

Pin Functions

PIN		I/O	DESCRIPTION
NO.	NAME		
1	IO1	I/O	The IO1 and IO2 pins are an ESD protected channel. Connect these pins to the data line as close to the connector as possible.
2	IO2	I/O	
3	GND	G	The GND (ground) pin is connected to ground.

6 Specifications

6.1 Absolute Maximum Ratings

over operating free-air temperature range (unless otherwise noted)⁽¹⁾

	MIN	MAX	UNIT
I _{PP} Peak pulse current (t _p = 8/20 μs)		5.5 ⁽²⁾	A
P _{PP} Peak pulse power (t _p = 8/20 μs)		75 ⁽²⁾	W
T _J Junction temperature	–40	125	°C
T _{stg} Storage temperature	–65	150	°C

(1) Stresses beyond those listed under *Absolute Maximum Ratings* may cause permanent damage to the device. These are stress ratings only, which do not imply functional operation of the device at these or any other conditions beyond those indicated under *Recommended Operating Conditions*. Exposure to absolute-maximum-rated conditions for extended periods may affect device reliability.

(2) Measured at 25°C.

6.2 ESD Ratings—AEC Specification

	VALUE	UNIT
V _(ESD) Electrostatic discharge	Human body model (HBM), per AEC Q100-002 ⁽¹⁾	±10000
	Charged device model (CDM), per AEC Q100-011	±1000

(1) AAEC Q100-002 indicates that HBM stressing shall be in accordance with the ANSI/ESDA/JEDEC JS-001 specification.

6.3 ESD Ratings—IEC Specification

	VALUE	UNIT
V _(ESD) Electrostatic discharge	IEC 61000-4-2	V
	Contact discharge	
	Air-gap discharge	±30000

6.4 ESD Ratings—ISO Specification

	VALUE	UNIT
V _(ESD) Electrostatic discharge	ISO 10605 (330 pF, 330 Ω)	V
	Contact discharge	
	Air-gap discharge	±25000

6.5 Recommended Operating Conditions

over operating free-air temperature range (unless otherwise noted)

	MIN	MAX	UNIT
V _{IO} Input pin voltage	0	5.5	V
T _A Operating free air temperature	–40	125	°C

6.6 Thermal Information

THERMAL METRIC ⁽¹⁾	TPD2E2U06-Q1		UNIT
	DBZ (SOT23)	DCK (SC70)	
	3 PINS	3 PINS	
R _{θJA} Junction-to-ambient thermal resistance	439.5	308.3	°C/W
R _{θJC(top)} Junction-to-case (top) thermal resistance	194.9	170.7	°C/W
R _{θJB} Junction-to-board thermal resistance	173.9	89.2	°C/W
ψ _{JT} Junction-to-top characterization parameter	53.7	34.2	°C/W
ψ _{JB} Junction-to-board characterization parameter	172	88.6	°C/W
R _{θJC(bot)} Junction-to-case (bottom) thermal resistance	N/A	N/A	°C/W

(1) For more information about traditional and new thermal metrics, see the *Semiconductor and IC Package Thermal Metrics* application report, [SPRA953](#).

6.7 Electrical Characteristics

over operating free-air temperature range (unless otherwise noted)

PARAMETER		TEST CONDITIONS	MIN	TYP	MAX	UNIT
V_{RWM}	Reverse stand-off voltage	$I_{IO} < 10 \mu A$			5.5	V
V_{CLAMP}	IO to GND	$I_{PP} = 1 A, TLP^{(1)(2)}$		9.7		V
		$I_{PP} = 5 A, TLP^{(1)(2)}$		12.4		
V_{CLAMP}	GND to IO	$I_{PP} = 1 A, TLP^{(1)(2)}$		1.9		V
		$I_{PP} = 5 A, TLP^{(1)(2)}$		4		
R_{DYN}	Dynamic resistance	IO to GND ⁽³⁾⁽²⁾		0.6		Ω
		GND to IO ⁽³⁾⁽²⁾		0.4		
C_L	Line capacitance	$f = 1 MHz, V_{BIAS} = 2.5 V^{(2)}$		1.5	1.9	pF
C_{CROSS}	Channel-to-channel input capacitance	Pin 3 = 0 V, $f = 1 MHz, V_{BIAS} = 2.5 V$, between channel pins ⁽²⁾		0.02	0.03	pF
ΔC_L	Variation of channel input capacitance	Pin 3 = 0 V, $f = 1 MHz, V_{BIAS} = 2.5 V$, Pin 1 to GND – Pin 2 to GND ⁽²⁾		0.03	0.1	pF
V_{BR}	Break-down voltage	$I_{IO} = 1 mA^{(2)}$	6.5		8.5	V
I_{LEAK}	Leakage current	$V_{IO} = 2.5 V$		1	10	nA

(1) Transmission Line Pulse with 10-ns rise time, 100-ns width.

(2) Measured at 25°C.

 (3) Extraction of R_{DYN} Using least squares fit of TLP characteristics between $I = 20 A$ and $I = 30 A$.

6.8 Typical Characteristics

Measured at $T_A = 25^\circ\text{C}$ unless otherwise specified

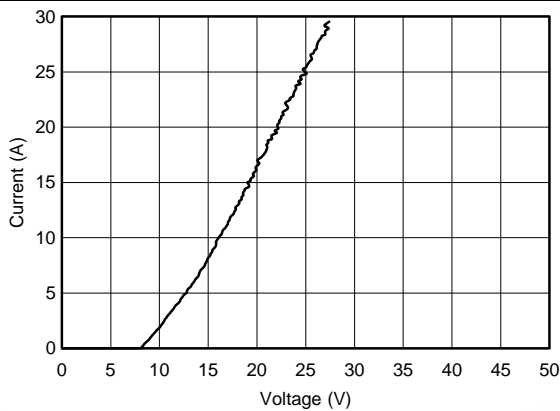

Figure 1. TLP, Data to GND

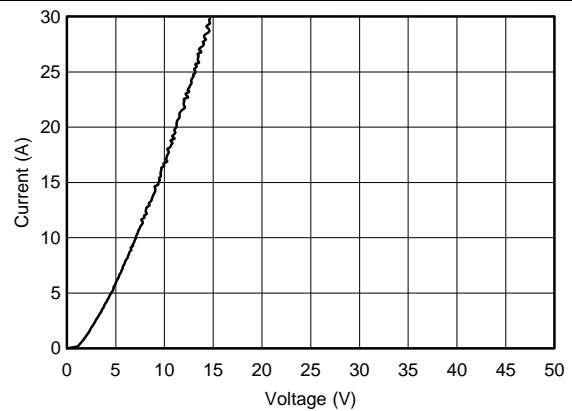

Figure 2. TLP, GND to Data

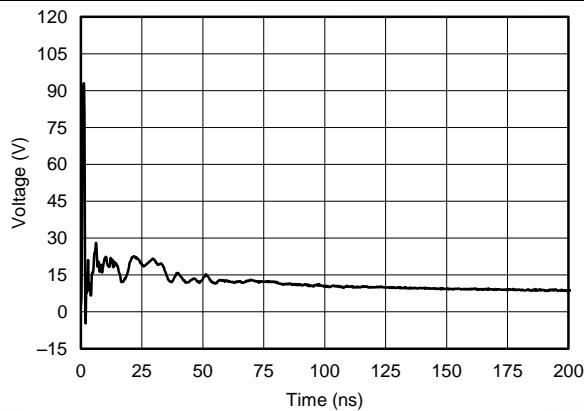

Figure 3. IEC 61000-4-2 Clamping Voltage, 8-kV Contact

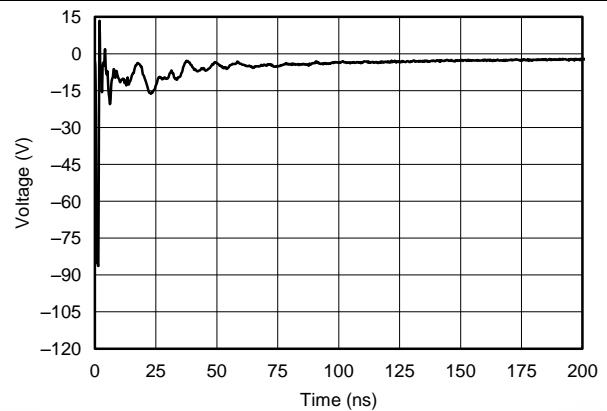

Figure 4. IEC 61000-4-2 Clamping Voltage, -8-kV Contact

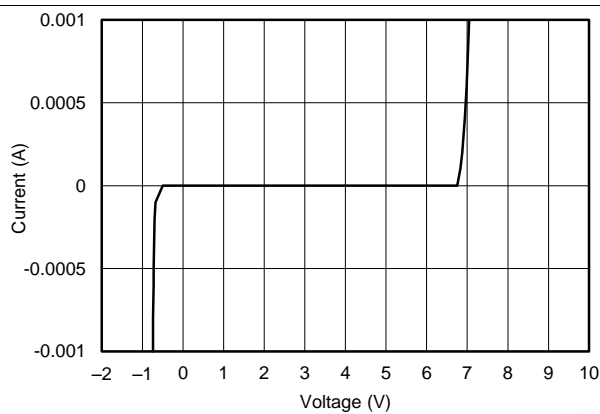

Figure 5. IV Curve, $T_A = 25^\circ\text{C}$

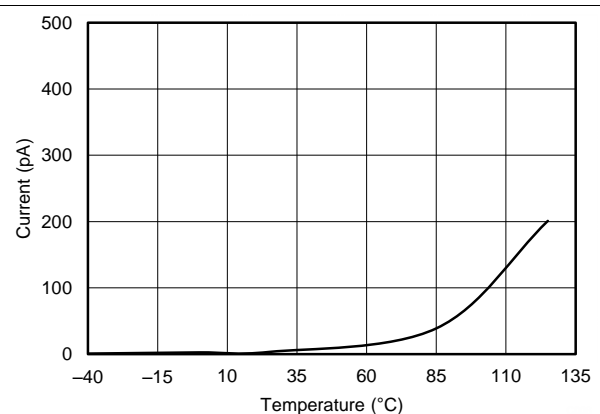
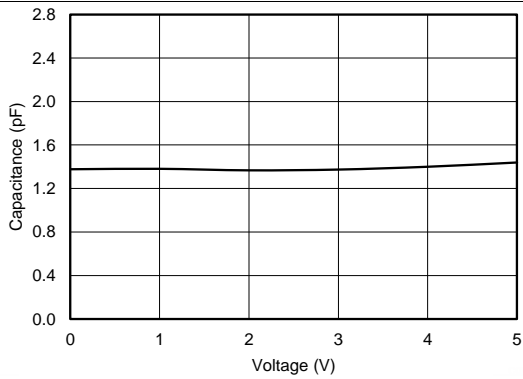

Figure 6. I_{LEAK} vs Temperature, $V_{IN} = 2.5\text{ V}$

Typical Characteristics (continued)

Measured at $T_A = 25^\circ\text{C}$ unless otherwise specified



**Figure 7. Capacitance Across V_{BIAS}
 $f = 1\text{ MHz}$**

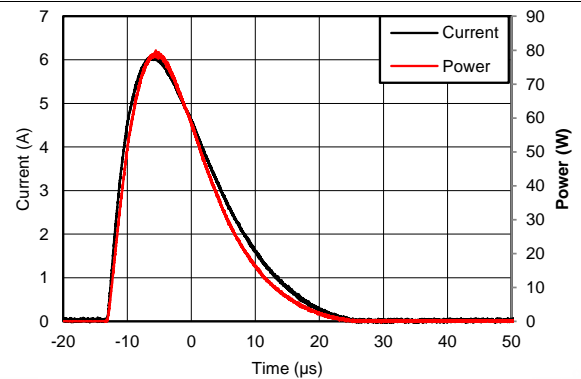

**Figure 8. Surge Curve ($t_p = 8/20\ \mu\text{s}$)
IO TO GND**

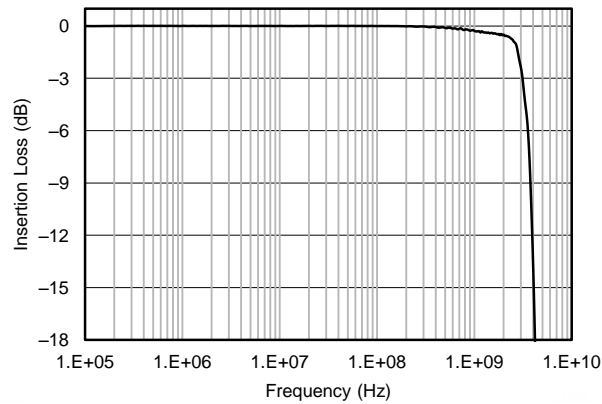

Figure 9. Insertion Loss

7 Detailed Description

7.1 Overview

The TPD2E2U06-Q1 device is a TVS ESD protection diode array with low capacitance. It is rated to dissipate ESD strikes above the maximum level specified in the IEC 61000-4-2 international standard. The 1.5-pF line capacitance makes it ideal for protecting interfaces such as USB 2.0, LVDS, Antenna, and I²C.

7.2 Functional Block Diagram

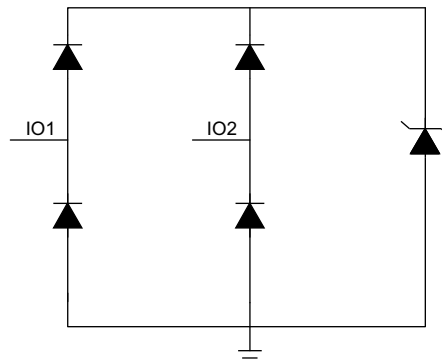

Copyright © 2016, Texas Instruments Incorporated

7.3 Feature Description

The TPD2E2U06-Q1 device is a TVS ESD protection diode array with low capacitance. It is rated to dissipate ESD strikes above the maximum level specified in the IEC 61000-4-2 international standard. The 1.5-pF line capacitance makes it ideal for protecting interfaces such as USB 2.0, LVDS, Antenna, and I²C.

7.3.1 AEC-Q101 Qualified

This device is qualified to AEC-Q101 standards. It passes HBM H3B (± 8 kV) and CDM C5 (± 1 kV) ESD ratings and is qualified to operate from -40°C to $+125^{\circ}\text{C}$.

7.3.2 IEC 61000-4-2 Level 4

The I/O pins can withstand ESD events up to ± 25 -kV contact and ± 30 -kV air. An ESD-surge clamp diverts the current to ground.

7.3.3 IO Capacitance

The capacitance between each I/O pin to ground is 1.5 pF. These capacitances support data rates in excess of 1.5 Gbps.

7.3.4 DC Breakdown Voltage

The DC breakdown voltage of each I/O pin is a minimum of 6.5 V. This ensures that sensitive equipment is protected from surges above the reverse standoff voltage of 5.5 V.

7.3.5 Ultra-Low Leakage Current

The I/O pins feature an ultra-low leakage current of 10 nA (Maximum) with a bias of 2.5 V.

7.3.6 Low ESD Clamping Voltage

The I/O pins feature an ESD clamp that is capable of clamping the voltage to 9.7 V ($I_{PP} = 1$ A).

7.3.7 Industrial Temperature Range

This device is designed to operate from -40°C to $+125^{\circ}\text{C}$.

Feature Description (continued)

7.3.8 Small Easy-to-Route Packages

The layout of this device makes it simple and easy to add protection to an existing layout. The packages offers flow-through routing, requiring minimal modification to an existing layout.

7.4 Device Functional Modes

The TPD2E2U06-Q1 device is a passive integrated circuit that triggers when voltages are above V_{BR} or below the lower diodes V_f (-0.6 V). During ESD events, voltages as high as ± 30 kV (air) can be directed to ground via the internal diode network. When the voltages on the protected line fall below the trigger levels of the TPD2E2U06-Q1 (usually within 10s of nano-seconds) the device reverts to passive.

8 Application and Implementation

NOTE

Information in the following applications sections is not part of the TI component specification, and TI does not warrant its accuracy or completeness. TI's customers are responsible for determining suitability of components for their purposes. Customers should validate and test their design implementation to confirm system functionality.

8.1 Application Information

The TPD2E2U06-Q1 device is a diode type TVS which is typically used to provide a path to ground for dissipating ESD events on hi-speed signal lines between a human interface connector and a system. As the current from ESD passes through the TVS, only a small voltage drop is present across the diode. This is the voltage presented to the protected IC. The low R_{DYN} of the triggered TVS holds this voltage, V_{CLAMP} , to a safe level for the protected IC.

8.2 Typical Application

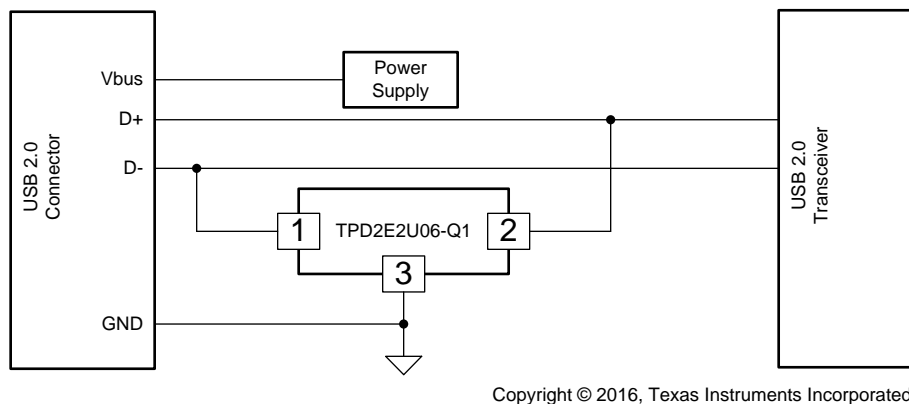

Figure 10. Typical USB Application Diagram

8.2.1 Design Requirements

For this design example, one TPD2E2U06-Q1 device will be used in a USB 2.0 application. This will provide complete port protection.

Given the USB 2.0 application, the parameters listed in [Table 1](#) are known.

Table 1. Design Parameters

DESIGN PARAMETER	VALUE
Signal range on pins 1 or 2	0 V to 3.3 V
Operating frequency	240 MHz

8.2.2 Detailed Design Procedure

8.2.2.1 Signal Range

The TPD2E2U06-Q1 device has 2 identical protection channels for signal lines. The symmetry of the device provides flexibility when selecting which of the 2 I/O channels will protect which signal lines. Any I/O will support a signal range of 0 to 5.5 V.

8.2.2.2 Operating Frequency

The TPD2E2U06-Q1 device has a capacitance of 1.5 pF (typical), supporting USB 2.0 data rates.

8.2.3 Application Curve

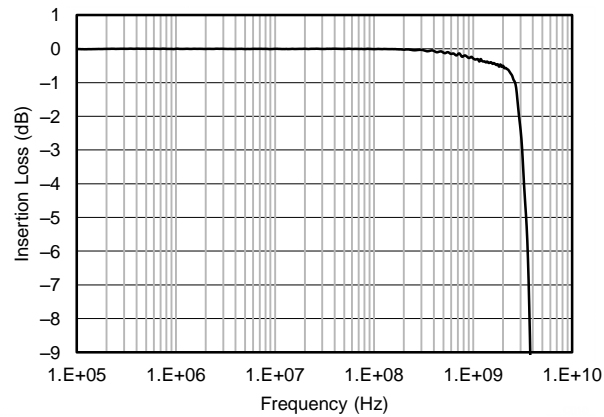

Figure 11. Insertion Loss Graph

9 Power Supply Recommendations

This device is a passive ESD protection device and there is no need to power it. Make sure that the maximum voltage specifications for each line are not violated.

10 Layout

10.1 Layout Guidelines

- The optimum placement is as close to the connector as possible.
 - EMI during an ESD event can couple from the trace being struck to other nearby unprotected traces, resulting in early system failures.
 - The PCB designer needs to minimize the possibility of EMI coupling by keeping any unprotected traces away from the protected traces which are between the TVS and the connector.
- Route the protected traces as straight as possible.
- Eliminate any sharp corners on the protected traces between the TVS and the connector by using rounded corners with the largest radii possible.
 - Electric fields tend to build up on corners, increasing EMI coupling.

10.2 Layout Example

This application is typical of a differential data pair application, such as USB 2.0.

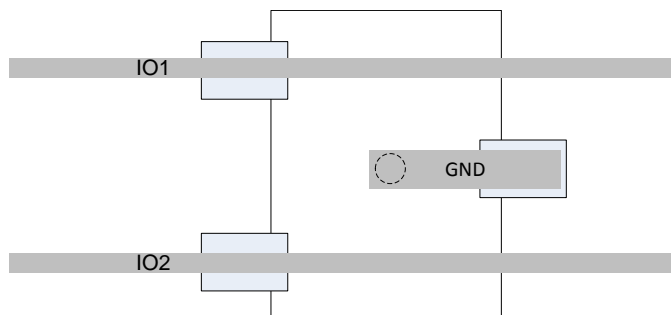

 = VIA to GND

Figure 12. Routing with DBZ Package

11 Device and Documentation Support

11.1 Documentation Support

11.1.1 Related Documentation

For related documentation see the following:

- *Reading and Understanding an ESD Protection Datasheet*, [SLLA305](#)
- *ESD Layout Guide*, [SLVA680](#)
- *TPD2E2U06QEVM User's Guide*, [SLVUAC6](#)

11.2 Community Resources

The following links connect to TI community resources. Linked contents are provided "AS IS" by the respective contributors. They do not constitute TI specifications and do not necessarily reflect TI's views; see TI's [Terms of Use](#).

TI E2E™ Online Community *TI's Engineer-to-Engineer (E2E) Community*. Created to foster collaboration among engineers. At e2e.ti.com, you can ask questions, share knowledge, explore ideas and help solve problems with fellow engineers.

Design Support *TI's Design Support* Quickly find helpful E2E forums along with design support tools and contact information for technical support.

11.3 Trademarks

E2E is a trademark of Texas Instruments.

All other trademarks are the property of their respective owners.

11.4 Electrostatic Discharge Caution



These devices have limited built-in ESD protection. The leads should be shorted together or the device placed in conductive foam during storage or handling to prevent electrostatic damage to the MOS gates.

11.5 Glossary

[SLYZ022](#) — *TI Glossary*.

This glossary lists and explains terms, acronyms, and definitions.

12 Mechanical, Packaging, and Orderable Information

The following pages include mechanical, packaging, and orderable information. This information is the most current data available for the designated devices. This data is subject to change without notice and revision of this document. For browser-based versions of this data sheet, refer to the left-hand navigation.

PACKAGING INFORMATION

Orderable Device	Status (1)	Package Type	Package Drawing	Pins	Package Qty	Eco Plan (2)	Lead/Ball Finish (6)	MSL Peak Temp (3)	Op Temp (°C)	Device Marking (4/5)	Samples
TPD2E2U06QDBZRQ1	ACTIVE	SOT-23	DBZ	3	3000	Green (RoHS & no Sb/Br)	CU NIPDAU	Level-2-260C-1 YEAR	-40 to 125	22U6Q	Samples
TPD2E2U06QDCKRQ1	ACTIVE	SC70	DCK	3	3000	Green (RoHS & no Sb/Br)	CU NIPDAU	Level-2-260C-1 YEAR	-40 to 125	11X	Samples

(1) The marketing status values are defined as follows:

ACTIVE: Product device recommended for new designs.

LIFEBUY: TI has announced that the device will be discontinued, and a lifetime-buy period is in effect.

NRND: Not recommended for new designs. Device is in production to support existing customers, but TI does not recommend using this part in a new design.

PREVIEW: Device has been announced but is not in production. Samples may or may not be available.

OBSELETE: TI has discontinued the production of the device.

(2) Eco Plan - The planned eco-friendly classification: Pb-Free (RoHS), Pb-Free (RoHS Exempt), or Green (RoHS & no Sb/Br) - please check <http://www.ti.com/productcontent> for the latest availability information and additional product content details.

TBD: The Pb-Free/Green conversion plan has not been defined.

Pb-Free (RoHS): TI's terms "Lead-Free" or "Pb-Free" mean semiconductor products that are compatible with the current RoHS requirements for all 6 substances, including the requirement that lead not exceed 0.1% by weight in homogeneous materials. Where designed to be soldered at high temperatures, TI Pb-Free products are suitable for use in specified lead-free processes.

Pb-Free (RoHS Exempt): This component has a RoHS exemption for either 1) lead-based flip-chip solder bumps used between the die and package, or 2) lead-based die adhesive used between the die and leadframe. The component is otherwise considered Pb-Free (RoHS compatible) as defined above.

Green (RoHS & no Sb/Br): TI defines "Green" to mean Pb-Free (RoHS compatible), and free of Bromine (Br) and Antimony (Sb) based flame retardants (Br or Sb do not exceed 0.1% by weight in homogeneous material)

(3) MSL, Peak Temp. - The Moisture Sensitivity Level rating according to the JEDEC industry standard classifications, and peak solder temperature.

(4) There may be additional marking, which relates to the logo, the lot trace code information, or the environmental category on the device.

(5) Multiple Device Markings will be inside parentheses. Only one Device Marking contained in parentheses and separated by a "~" will appear on a device. If a line is indented then it is a continuation of the previous line and the two combined represent the entire Device Marking for that device.

(6) Lead/Ball Finish - Orderable Devices may have multiple material finish options. Finish options are separated by a vertical ruled line. Lead/Ball Finish values may wrap to two lines if the finish value exceeds the maximum column width.

Important Information and Disclaimer: The information provided on this page represents TI's knowledge and belief as of the date that it is provided. TI bases its knowledge and belief on information provided by third parties, and makes no representation or warranty as to the accuracy of such information. Efforts are underway to better integrate information from third parties. TI has taken and continues to take reasonable steps to provide representative and accurate information but may not have conducted destructive testing or chemical analysis on incoming materials and chemicals. TI and TI suppliers consider certain information to be proprietary, and thus CAS numbers and other limited information may not be available for release.

In no event shall TI's liability arising out of such information exceed the total purchase price of the TI part(s) at issue in this document sold by TI to Customer on an annual basis.

OTHER QUALIFIED VERSIONS OF TPD2E2U06-Q1 :

- Catalog: [TPD2E2U06](#)

NOTE: Qualified Version Definitions:

- Catalog - TI's standard catalog product

TAPE AND REEL INFORMATION



QUADRANT ASSIGNMENTS FOR PIN 1 ORIENTATION IN TAPE



*All dimensions are nominal

Device	Package Type	Package Drawing	Pins	SPQ	Reel Diameter (mm)	Reel Width W1 (mm)	A0 (mm)	B0 (mm)	K0 (mm)	P1 (mm)	W (mm)	Pin1 Quadrant
TPD2E2U06QDBZRQ1	SOT-23	DBZ	3	3000	180.0	8.4	3.15	2.77	1.22	4.0	8.0	Q3
TPD2E2U06QDCKRQ1	SC70	DCK	3	3000	178.0	9.0	2.4	2.5	1.2	4.0	8.0	Q3

TAPE AND REEL BOX DIMENSIONS

*All dimensions are nominal

Device	Package Type	Package Drawing	Pins	SPQ	Length (mm)	Width (mm)	Height (mm)
TPD2E2U06QDBZRQ1	SOT-23	DBZ	3	3000	223.0	270.0	35.0
TPD2E2U06QDCKRQ1	SC70	DCK	3	3000	180.0	180.0	18.0

GENERIC PACKAGE VIEW

DBZ 3

SOT-23 - 1.12 mm max height

SMALL OUTLINE TRANSISTOR

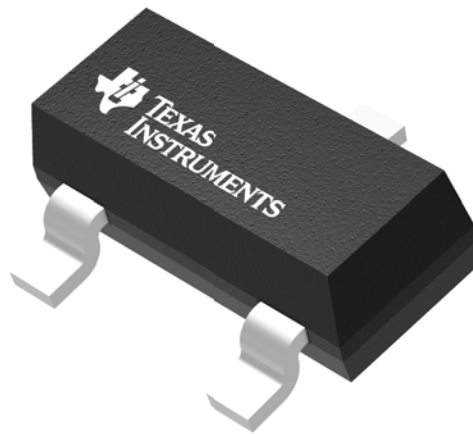

Images above are just a representation of the package family, actual package may vary.
Refer to the product data sheet for package details.

4203227/C

DBZ0003A

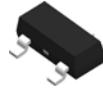

PACKAGE OUTLINE

SOT-23 - 1.12 mm max height

SMALL OUTLINE TRANSISTOR

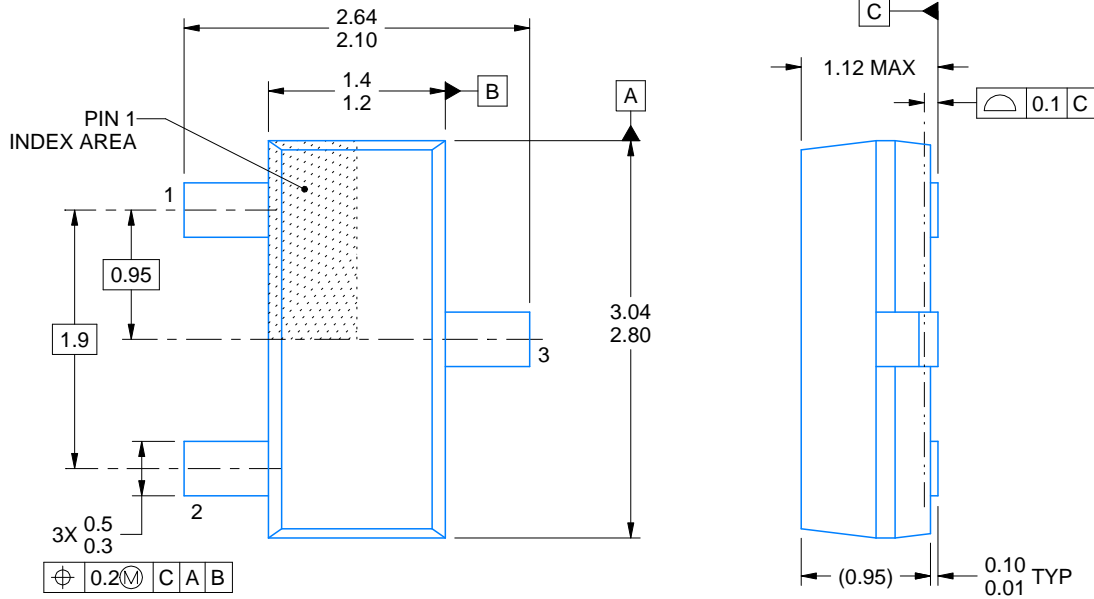

4214838/C 04/2017

NOTES:

1. All linear dimensions are in millimeters. Any dimensions in parenthesis are for reference only. Dimensioning and tolerancing per ASME Y14.5M.
2. This drawing is subject to change without notice.
3. Reference JEDEC registration TO-236, except minimum foot length.

EXAMPLE BOARD LAYOUT

DBZ0003A

SOT-23 - 1.12 mm max height

SMALL OUTLINE TRANSISTOR

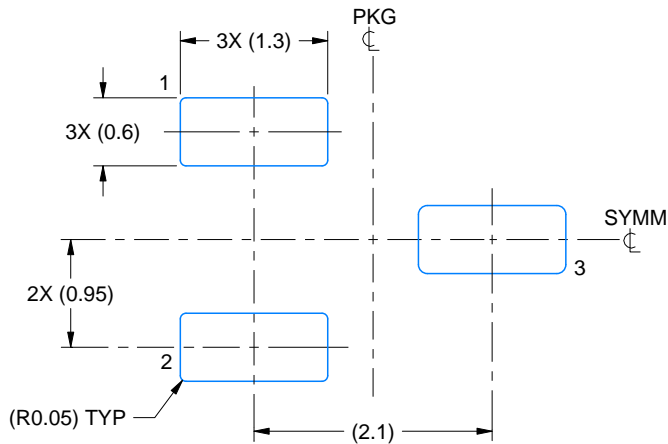

LAND PATTERN EXAMPLE
SCALE:15X

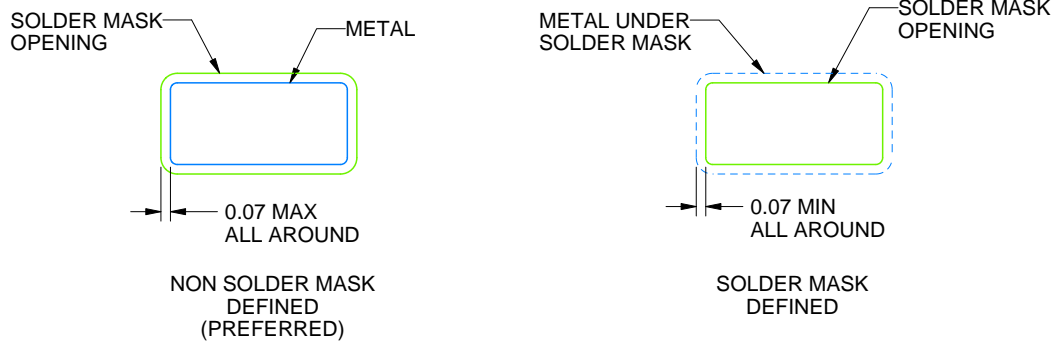

SOLDER MASK DETAILS

4214838/C 04/2017

NOTES: (continued)

- 4. Publication IPC-7351 may have alternate designs.
- 5. Solder mask tolerances between and around signal pads can vary based on board fabrication site.

EXAMPLE STENCIL DESIGN

DBZ0003A

SOT-23 - 1.12 mm max height

SMALL OUTLINE TRANSISTOR

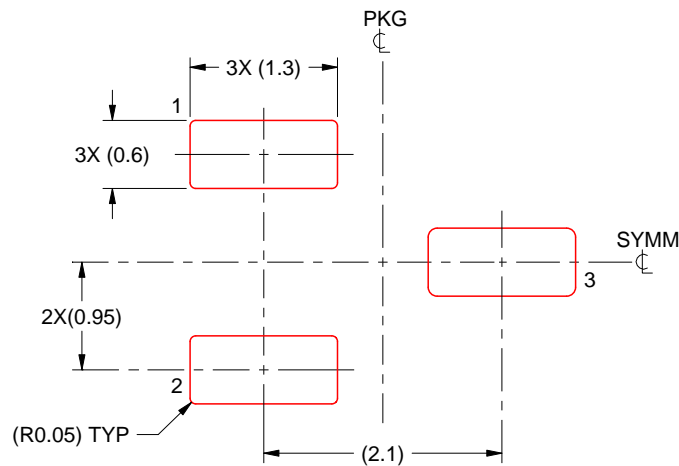

SOLDER PASTE EXAMPLE
BASED ON 0.125 THICK STENCIL
SCALE:15X

4214838/C 04/2017

NOTES: (continued)

6. Laser cutting apertures with trapezoidal walls and rounded corners may offer better paste release. IPC-7525 may have alternate design recommendations.
7. Board assembly site may have different recommendations for stencil design.

IMPORTANT NOTICE

Texas Instruments Incorporated (TI) reserves the right to make corrections, enhancements, improvements and other changes to its semiconductor products and services per JESD46, latest issue, and to discontinue any product or service per JESD48, latest issue. Buyers should obtain the latest relevant information before placing orders and should verify that such information is current and complete.

TI's published terms of sale for semiconductor products (<http://www.ti.com/sc/docs/stdterms.htm>) apply to the sale of packaged integrated circuit products that TI has qualified and released to market. Additional terms may apply to the use or sale of other types of TI products and services.

Reproduction of significant portions of TI information in TI data sheets is permissible only if reproduction is without alteration and is accompanied by all associated warranties, conditions, limitations, and notices. TI is not responsible or liable for such reproduced documentation. Information of third parties may be subject to additional restrictions. Resale of TI products or services with statements different from or beyond the parameters stated by TI for that product or service voids all express and any implied warranties for the associated TI product or service and is an unfair and deceptive business practice. TI is not responsible or liable for any such statements.

Buyers and others who are developing systems that incorporate TI products (collectively, "Designers") understand and agree that Designers remain responsible for using their independent analysis, evaluation and judgment in designing their applications and that Designers have full and exclusive responsibility to assure the safety of Designers' applications and compliance of their applications (and of all TI products used in or for Designers' applications) with all applicable regulations, laws and other applicable requirements. Designer represents that, with respect to their applications, Designer has all the necessary expertise to create and implement safeguards that (1) anticipate dangerous consequences of failures, (2) monitor failures and their consequences, and (3) lessen the likelihood of failures that might cause harm and take appropriate actions. Designer agrees that prior to using or distributing any applications that include TI products, Designer will thoroughly test such applications and the functionality of such TI products as used in such applications.

TI's provision of technical, application or other design advice, quality characterization, reliability data or other services or information, including, but not limited to, reference designs and materials relating to evaluation modules, (collectively, "TI Resources") are intended to assist designers who are developing applications that incorporate TI products; by downloading, accessing or using TI Resources in any way, Designer (individually or, if Designer is acting on behalf of a company, Designer's company) agrees to use any particular TI Resource solely for this purpose and subject to the terms of this Notice.

TI's provision of TI Resources does not expand or otherwise alter TI's applicable published warranties or warranty disclaimers for TI products, and no additional obligations or liabilities arise from TI providing such TI Resources. TI reserves the right to make corrections, enhancements, improvements and other changes to its TI Resources. TI has not conducted any testing other than that specifically described in the published documentation for a particular TI Resource.

Designer is authorized to use, copy and modify any individual TI Resource only in connection with the development of applications that include the TI product(s) identified in such TI Resource. NO OTHER LICENSE, EXPRESS OR IMPLIED, BY ESTOPPEL OR OTHERWISE TO ANY OTHER TI INTELLECTUAL PROPERTY RIGHT, AND NO LICENSE TO ANY TECHNOLOGY OR INTELLECTUAL PROPERTY RIGHT OF TI OR ANY THIRD PARTY IS GRANTED HEREIN, including but not limited to any patent right, copyright, mask work right, or other intellectual property right relating to any combination, machine, or process in which TI products or services are used. Information regarding or referencing third-party products or services does not constitute a license to use such products or services, or a warranty or endorsement thereof. Use of TI Resources may require a license from a third party under the patents or other intellectual property of the third party, or a license from TI under the patents or other intellectual property of TI.

TI RESOURCES ARE PROVIDED "AS IS" AND WITH ALL FAULTS. TI DISCLAIMS ALL OTHER WARRANTIES OR REPRESENTATIONS, EXPRESS OR IMPLIED, REGARDING RESOURCES OR USE THEREOF, INCLUDING BUT NOT LIMITED TO ACCURACY OR COMPLETENESS, TITLE, ANY EPIDEMIC FAILURE WARRANTY AND ANY IMPLIED WARRANTIES OF MERCHANTABILITY, FITNESS FOR A PARTICULAR PURPOSE, AND NON-INFRINGEMENT OF ANY THIRD PARTY INTELLECTUAL PROPERTY RIGHTS. TI SHALL NOT BE LIABLE FOR AND SHALL NOT DEFEND OR INDEMNIFY DESIGNER AGAINST ANY CLAIM, INCLUDING BUT NOT LIMITED TO ANY INFRINGEMENT CLAIM THAT RELATES TO OR IS BASED ON ANY COMBINATION OF PRODUCTS EVEN IF DESCRIBED IN TI RESOURCES OR OTHERWISE. IN NO EVENT SHALL TI BE LIABLE FOR ANY ACTUAL, DIRECT, SPECIAL, COLLATERAL, INDIRECT, PUNITIVE, INCIDENTAL, CONSEQUENTIAL OR EXEMPLARY DAMAGES IN CONNECTION WITH OR ARISING OUT OF TI RESOURCES OR USE THEREOF, AND REGARDLESS OF WHETHER TI HAS BEEN ADVISED OF THE POSSIBILITY OF SUCH DAMAGES.

Unless TI has explicitly designated an individual product as meeting the requirements of a particular industry standard (e.g., ISO/TS 16949 and ISO 26262), TI is not responsible for any failure to meet such industry standard requirements.

Where TI specifically promotes products as facilitating functional safety or as compliant with industry functional safety standards, such products are intended to help enable customers to design and create their own applications that meet applicable functional safety standards and requirements. Using products in an application does not by itself establish any safety features in the application. Designers must ensure compliance with safety-related requirements and standards applicable to their applications. Designer may not use any TI products in life-critical medical equipment unless authorized officers of the parties have executed a special contract specifically governing such use. Life-critical medical equipment is medical equipment where failure of such equipment would cause serious bodily injury or death (e.g., life support, pacemakers, defibrillators, heart pumps, neurostimulators, and implantables). Such equipment includes, without limitation, all medical devices identified by the U.S. Food and Drug Administration as Class III devices and equivalent classifications outside the U.S.

TI may expressly designate certain products as completing a particular qualification (e.g., Q100, Military Grade, or Enhanced Product). Designers agree that it has the necessary expertise to select the product with the appropriate qualification designation for their applications and that proper product selection is at Designers' own risk. Designers are solely responsible for compliance with all legal and regulatory requirements in connection with such selection.

Designer will fully indemnify TI and its representatives against any damages, costs, losses, and/or liabilities arising out of Designer's non-compliance with the terms and provisions of this Notice.