



Technical Data Sheet

Infrared Remote control Receiver Module Own Inner Shield

IRM-37xxN3 SERIES

Features

- High protection ability against EMI .
- Circular lens to improve the receive characteristic.
- Line-up for various center carrier frequencies.
- Low voltage and low power consumption.
- High immunity against ambient light.
- Photodiode with integrated circuit.
- TTL and CMOS compatibility.
- Long reception distance.
- High sensitivity.
- Pb free.
- The product itself will remain within RoHS compliant version.

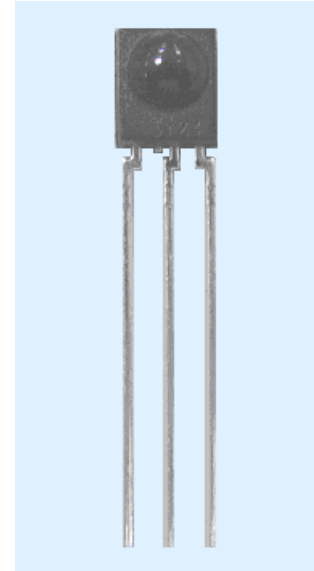

Descriptions

The device is a miniature type infrared remote control system receiver which has been developed and designed by utilizing the most updated IC technology. The PIN diode and preamplifier are assembled on lead frame, the epoxy package is designed as an IR filter. The demodulated output signal can directly be decoded by a microprocessor.

Applications

- Light detecting portion of remote control
- AV instruments such as Audio, TV, VCR, CD, MD, etc.
- Home appliances such as Air-conditioner, Fan , etc.
- The other equipments with wireless remote control.
- CATV set top boxes
- Multi-media Equipment

| PART | MATERIAL | COLOR |
|----------|----------|-------|
| Chip | Silicon | Black |
| Compound | Epoxy | Black |

IRM-37xxN3 SERIES

Package Dimensions

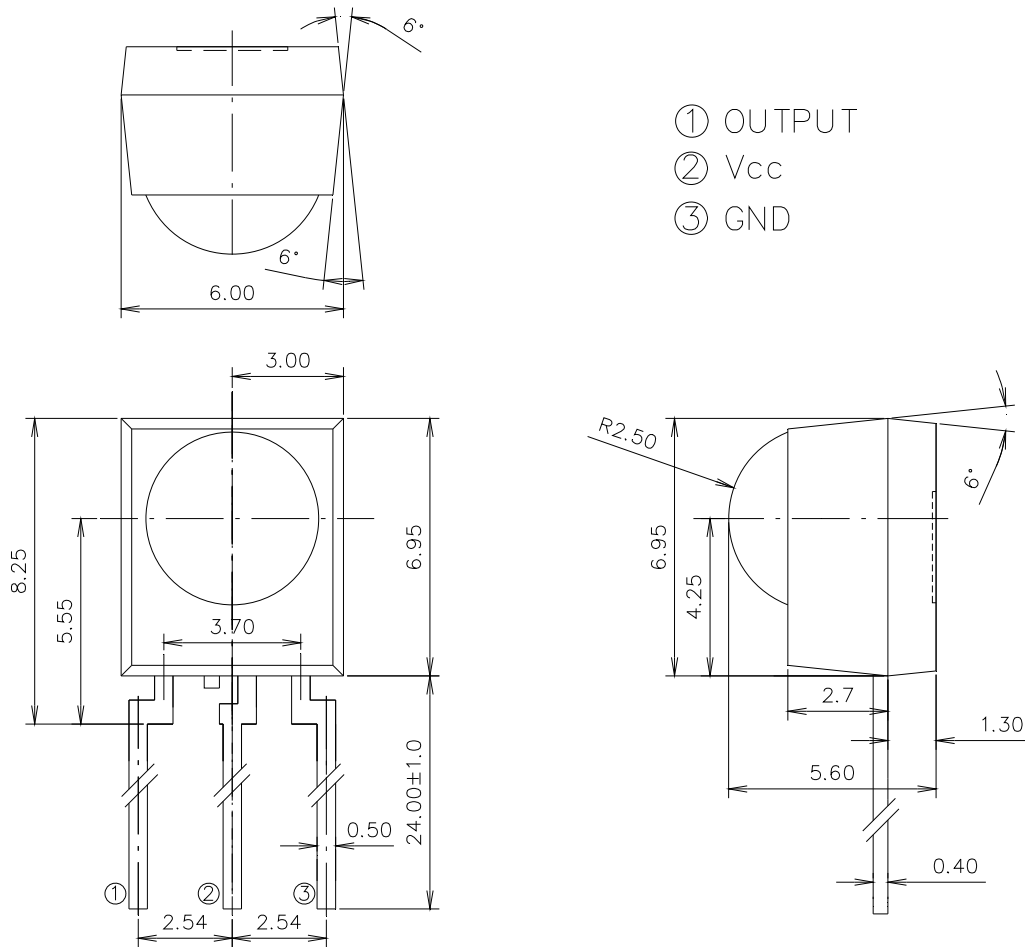

- ① OUTPUT
- ② Vcc
- ③ GND

Unit:mm

- Notes:** 1.All dimensions are in millimeters.
2.Tolerances unless dimensions ± 0.3 mm.

Available Types For Different Carrier Frequencies

| Type | Carrier Frequencies (Typ) |
|------------|---------------------------|
| IRM-3633N3 | 33 kHz |
| IRM-3636N3 | 36 kHz |
| IRM-3638N3 | 38 kHz |
| IRM-3640N3 | 40 kHz |
| IRM-3656N3 | 56 kHz |

IRM-37xxN3 SERIES
Absolute Maximum Ratings (Ta=25°C)

| Parameter | Symbol | Rating | Unit | Notice |
|-----------------------|--------|-----------|------|--|
| Supply Voltage | Vcc | 0~6 | V | |
| Operating Temperature | Topr | -25 ~ +85 | °C | |
| Storage Temperature | Tstg | -40 ~ +85 | °C | |
| Soldering Temperature | Tsol | 260 | °C | 4mm from mold body less than 10 seconds |

Recommended Operating Condition
Supply Voltage Rating: Vcc 2.7V to 5.5V
Electro-Optical Characteristics (Ta=25°C, and Vcc=3.0V)

| Parameter | Symbol | MIN. | TYP. | MAX. | Unit | Condition |
|---------------------------|-----------------|------|------|------|---------|-----------------------|
| Consumption Current | Icc | 0.7 | 0.9 | 2.0 | mA | No signal input |
| Peak Wavelength | λ_p | --- | 940 | --- | nm | |
| Reception Distance | L ₀ | 14 | --- | --- | m | At the ray axis *1 |
| | L ₄₅ | 6 | --- | --- | | |
| Half Angle(Horizontal) | Θ_h | --- | 45 | --- | deg | |
| Half Angle(Vertical) | Θ_v | --- | 45 | --- | deg | |
| High Level Pulse Width | T _H | 400 | --- | 800 | μs | |
| Low Level Pulse Width | T _L | 400 | --- | 800 | μs | |
| High Level Output Voltage | V _H | 2.7 | --- | --- | V | |
| Low Level Output Voltage | V _L | --- | 0.2 | 0.5 | V | |

*1:The ray receiving surface at a vertex and relation to the ray axis in the range of $\theta=0^\circ$ and $\theta=45^\circ$.

*2:A range from 30cm to the arrival distance. Average value of 50 pulses.

Test Method :

The specified electro-optical characteristics is satisfied under the following Conditions at the controllable distance.

①Measurement place

A place that is nothing of extreme light reflected in the room.

②External light

Project the light of ordinary white fluorescent lamps which are not high Frequency lamps and must be less then 10 Lux at the module surface.

($E_e \leq 10\text{Lux}$)

③Standard transmitter

A transmitter whose output is so adjusted as to $V_o=400\text{mVp-p}$ and the output Wave form shown in Fig.-1.According to the measurement method shown in Fig.-2 the standard transmitter is specified.

However , the infrared photodiode to be used for the transmitter should be $\lambda_p=940\text{nm}, \Delta\lambda=50\text{nm}$. Also, photodiode is used of PD438B($V_r=5\text{V}$).

④Measuring system

According to the measuring system shown in Fig.-3

Fig.-1 Transmitter Wave Form

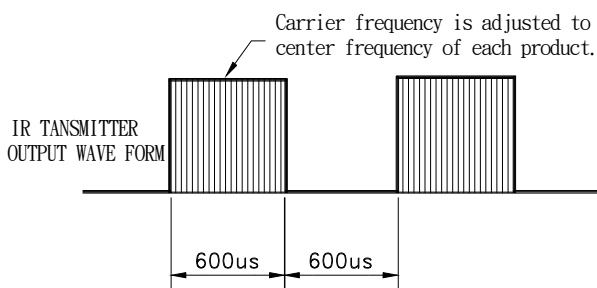

D.U.T output Pulse

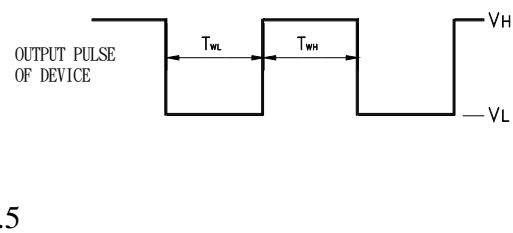

IRM-37xxN3 SERIES

Fig.-2 Measuring Method

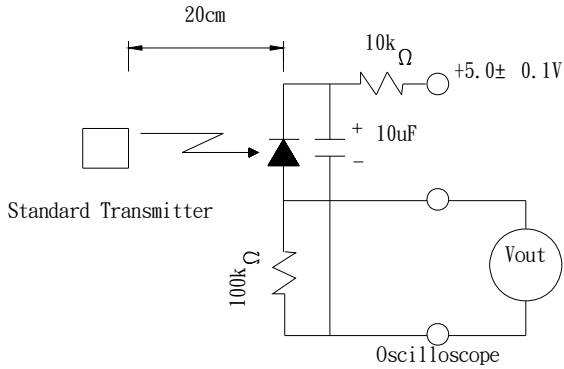
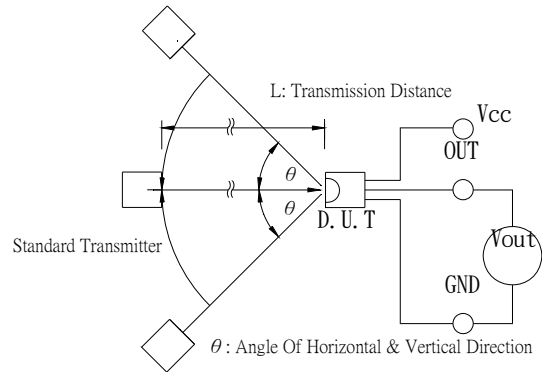
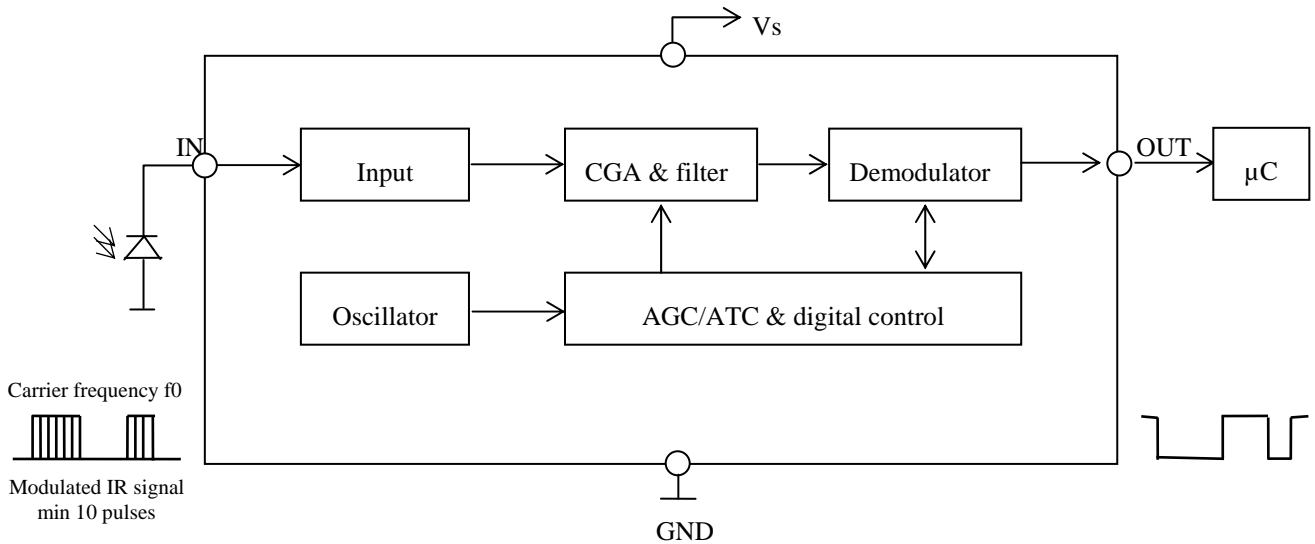

Fig.-3 Measuring System



Block Diagram :



Application Circuit :

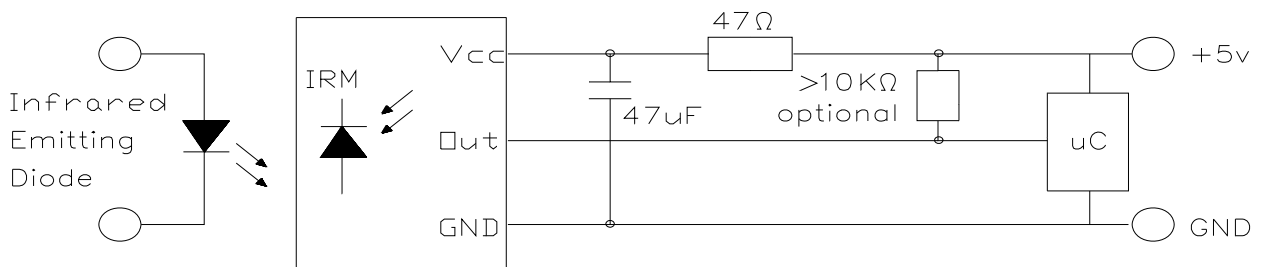

RC Filter should be connected closely between Vcc pin and GND pin.

IRM-37xxN3 SERIES

Typical Electro-Optical Characteristics Curves

Fig.-4 Relative Spectral Sensitivity vs. Wavelength

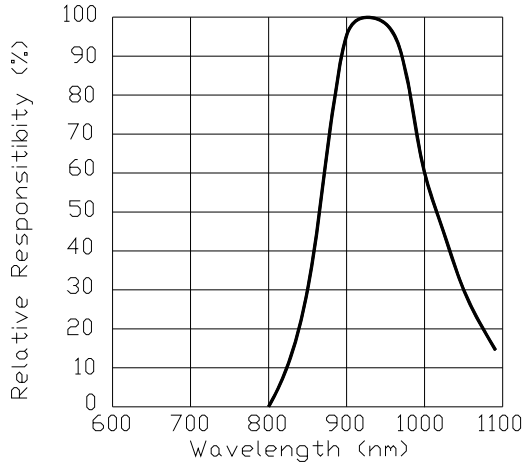

Fig.-5 Relative Transmission Distance vs. Direction

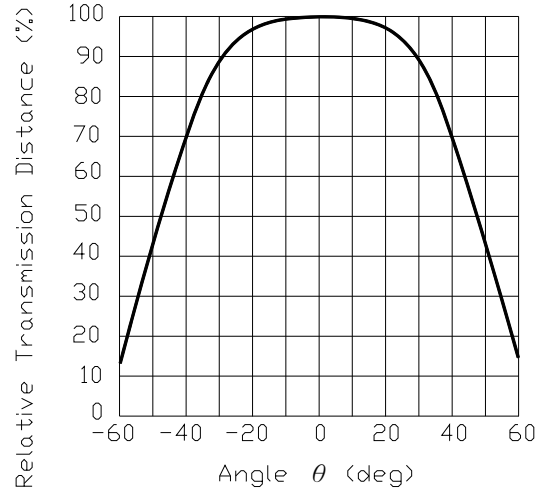

Fig.-6 Arrival Distance vs. Ambient Temperature

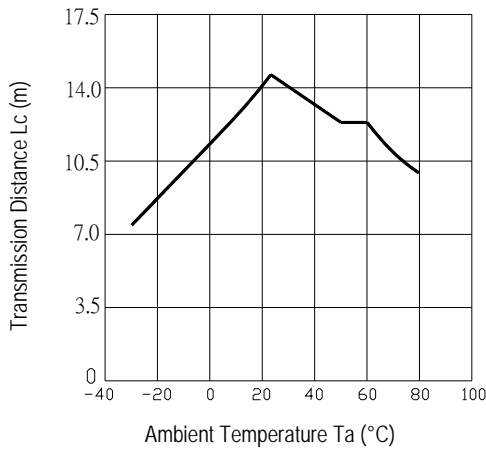

Fig.-7 Arrival Distance vs. Supply Voltage

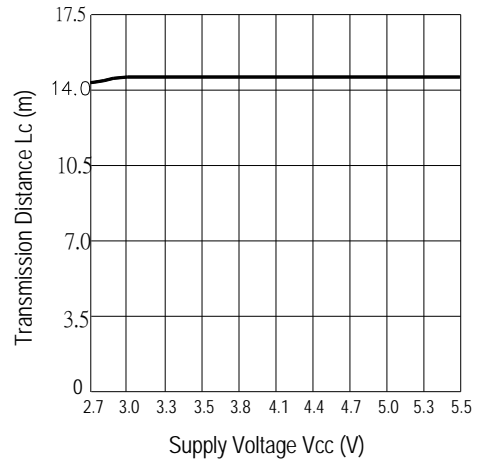
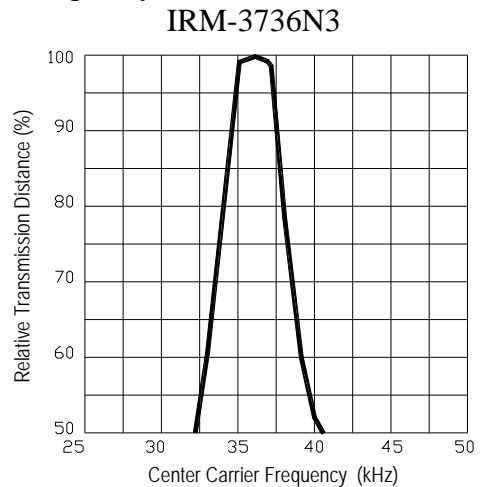
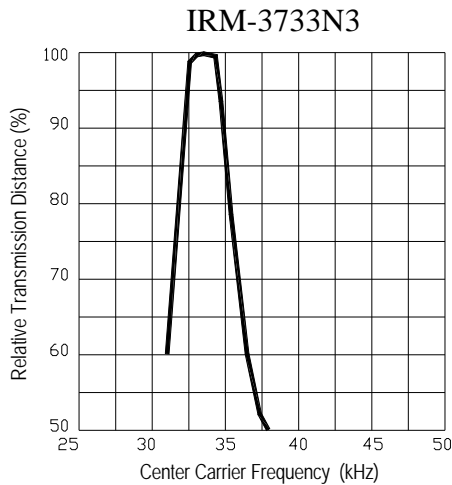

Fig.-8 Relative Transmission Distance vs. Center Carrier Frequency



IRM-37xxN3 SERIES

Typical Electro-Optical Characteristics Curves

Fig.-8 Relative Transmission Distance vs. Center Carrier Frequency

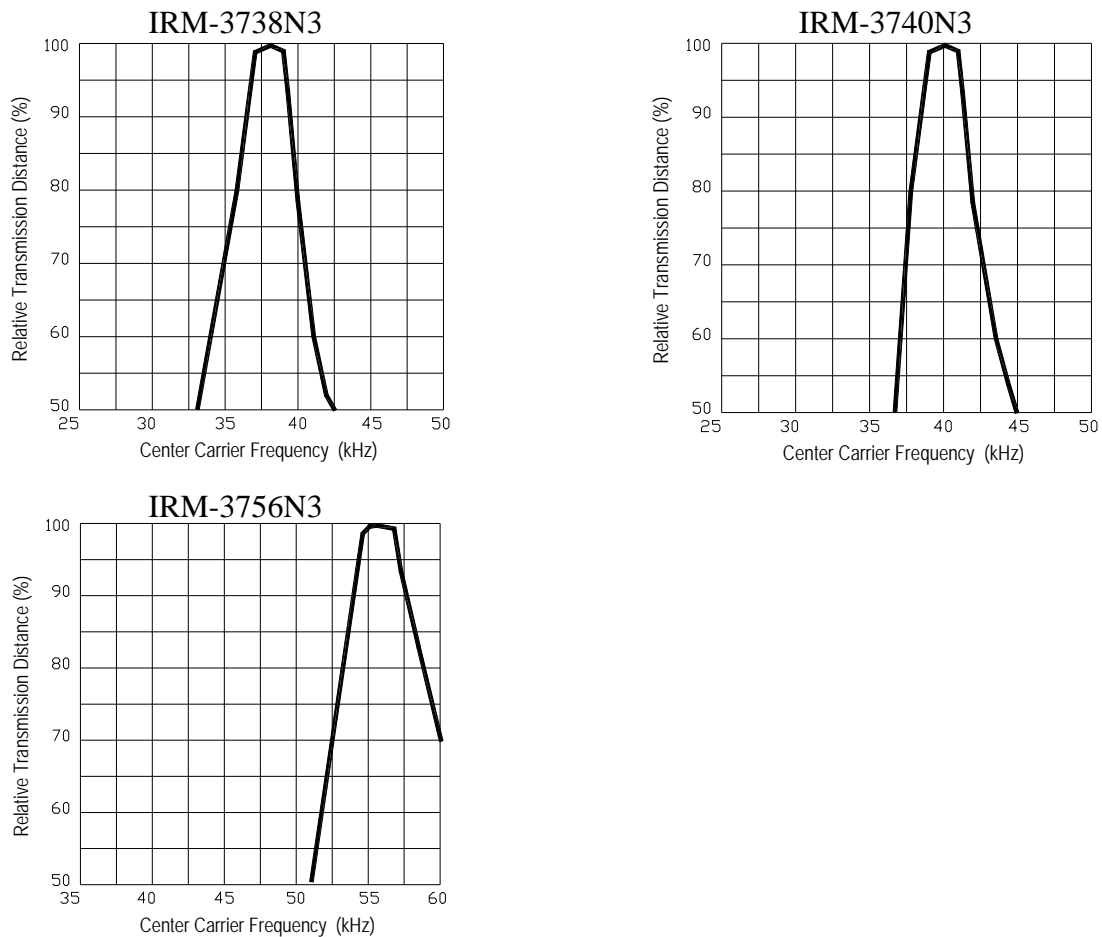
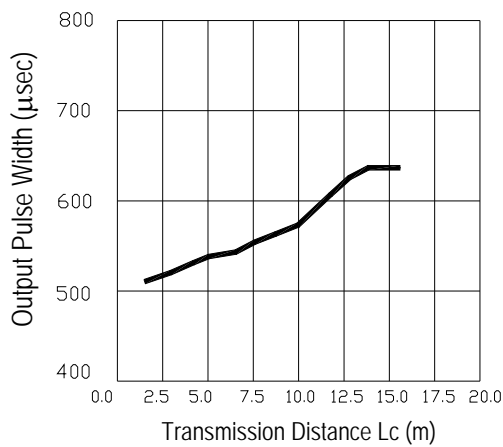

Fig.-9 Relative Transmission Distance vs. Center Carrier Frequency



Reliability Test Item And Condition

The reliability of products shall be satisfied with items listed below.

Confidence level : 90%

LTPD : 10%

| Test Items | Test Conditions | Failure Judgement Criteria | Samples(n) Defective(c) |
|-----------------------------------|--|---|----------------------------|
| Temperature cycle | 1 cycle -40°C \longleftrightarrow +100°C (15min)(5min)(15min) 300 cycle test | $L_0 \leq L \times 0.8$ $L_{45} \leq L \times 0.8$ L: Lower specification limit | n=22,c=0 |
| High temperature test | Temp: +100°C Vcc:6V 1000hrs | | n=22,c=0 |
| Low temperature storage | Temp: -40°C 1000hrs | | n=22,c=0 |
| High temperature High humidity | Ta: 85°C,RH:85% 1000hrs | | n=22,c=0 |
| Solder heat | Temp: 260±5°C 10sec 4mm From the bottom of the package. | | n=22,c=0 |

Packing Quantity Specification

1. 1500 PCS/1Box
2. 10 Boxes/1Carton

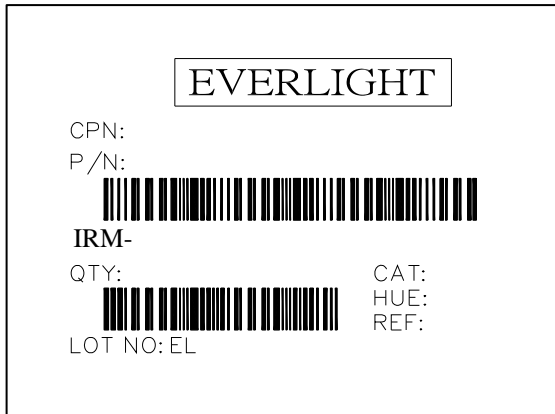
Label Form Specification

CPN: Customer's Production Number
P/N : Production Number
QTY: Packing Quantity
CAT: Ranks
HUE: Peak Wavelength
REF: Reference
LOT No: Lot Number
MADE IN TAIWAN: Production Place

Notes

1. Above specification may be changed without notice. EVERLIGHT will reserve authority on material change for above specification.
2. When using this product, please observe the absolute maximum ratings and the instructions for using outlined in these specification sheets. EVERLIGHT assumes no responsibility for any damage resulting from use of the product which does not comply with the absolute maximum ratings and the instructions included in these specification sheets.
3. These specification sheets include materials protected under copyright of EVERLIGHT corporation. Please don't reproduce or cause anyone to reproduce them without EVERLIGHT's consent.

EVERLIGHT ELECTRONICS CO., LTD.
Office: No 25, Lane 76, Sec 3, Chung Yang Rd,
Tucheng, Taipei 236, Taiwan, R.O.C

Tel: 886-2-2267-2000, 2267-9936
Fax: 886-2267-6244, 2267-6189, 2267-6306
<http://www.everlight.com>