

NaOS™ NXA025 SMT Non-isolated Power Modules: 10Vdc – 14Vdc Input; 0.8Vdc to 5.5Vdc Output; 25A Output Current

RoHS Compliant

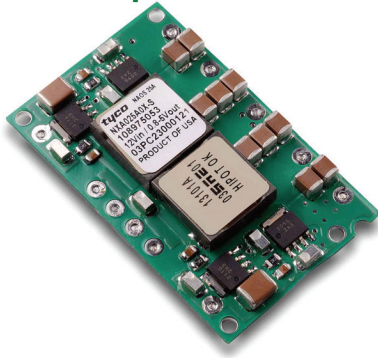

Applications

- Distributed power architectures
- Intermediate bus voltage applications
- Telecommunications equipment
- Servers and storage applications
- Networking equipment
- Enterprise Networks
- Latest generation IC's (DSP, FPGA, ASIC) and Microprocessor powered applications

Options

- Baseplate version for heatsink attachment (-H suffix)
- Through Hole version (-L)
- Paralleling with current sharing (-P)

Description

The NXA025 series SMT (surface-mount technology) power modules are non-isolated dc-dc converters that can deliver up to 25A of output current with full load efficiency of 93% at 3.3Vdc output voltage. These modules provide a precisely regulated output voltage from 0.8Vdc to 5.5Vdc, programmable via an external resistor. Their open-frame construction and small footprint enable designers to develop cost- and space-efficient solutions. Standard features include remote On/Off, adjustable output voltage, remote sense, active current sharing between parallel modules, output voltage sequencing of multiple modules, overcurrent, overvoltage, and overtemperature protection.

Features

- Compliant to RoHS EU Directive 2002/95/EC (-Z versions)
- Compliant to ROHS EU Directive 2002/95/EC with lead solder exemption (non-Z versions)
- Delivers up to 25A output current
- High efficiency – 93% at 3.3V full load
- Small size and low profile:
47.2 mm x 29.4 mm x 8.50 mm
(1.86 in x 1.16 in x 0.335 in)
- Low output ripple and noise
- Constant switching frequency (500 kHz)
- Surface mount or through hole
- Output voltage programmable from 0.8 Vdc to 5.5Vdc via external resistor
- Remote On/Off
- Remote Sense
- Parallel operation with current sharing (-P option)
- Output voltage sequencing (multiple modules)
- Output overvoltage protection
- Overtemperature protection
- Output overcurrent protection (non-latching)
- Wide operating temperature range (-40°C to 85°C)
- *UL** 60950-1 Recognized, *CSA*[†] C22.2 No. 60950-1-03 Certified, and *VDE*[‡] 0805:2001-12 (EN60950-1) Licensed
- ISO** 9001 and ISO 14001 certified manufacturing facilities

* *UL* is a registered trademark of Underwriters Laboratories, Inc.

[†] *CSA* is a registered trademark of Canadian Standards Association.

[‡] *VDE* is a trademark of Verband Deutscher Elektrotechniker e.V.

** ISO is a registered trademark of the International Organization of Standards

Absolute Maximum Ratings

Stresses in excess of the absolute maximum ratings can cause permanent damage to the device. These are absolute stress ratings only, functional operation of the device is not implied at these or any other conditions in excess of those given in the operations sections of the data sheet. Exposure to absolute maximum ratings for extended periods can adversely affect the device reliability.

| Parameter | Device | Symbol | Min | Max | Unit |
|---|--------|-----------|------|-----|------|
| Input Voltage Continuous | All | V_{IN} | -0.3 | 14 | Vdc |
| Operating Ambient Temperature (see Thermal Considerations section) | All | T_A | -40 | 85 | °C |
| Storage Temperature | All | T_{stg} | -55 | 125 | °C |

Electrical Specifications

Unless otherwise indicated, specifications apply over all operating input voltage, resistive load, and temperature conditions.

| Parameter | Device | Symbol | Min | Typ | Max | Unit |
|---|--------|--------------|------|------|------|------------------|
| Operating Input Voltage | All | V_{IN} | 10.0 | 12.0 | 14.0 | Vdc |
| Maximum Input Current ($V_{IN}=10.0V$ to $14.0V$, $I_O=I_{O,max}$) | All | $I_{IN,max}$ | | | 14 | Adc |
| Inrush Transient | All | I^2t | | | 1 | A ² s |
| Input Reflected Ripple Current, peak-to-peak (5Hz to 20MHz, 1 μ H source impedance; $V_{IN,min}$ to $V_{IN,max}$, $I_O=I_{O,max}$; See Test configuration section) | All | | | 60 | | mAp-p |
| Input Ripple Rejection (120Hz) | All | | | 50 | | dB |

CAUTION: This power module is not internally fused. An input line fuse must always be used.

This power module can be used in a wide variety of applications, ranging from simple standalone operation to being part of a complex power architecture. To preserve maximum flexibility, internal fusing is not included, however, to achieve maximum safety and system protection, always use an input line fuse. The safety agencies require a fast-acting fuse with a maximum rating of 30A (see Safety Considerations section). Based on the information provided in this data sheet on inrush energy and maximum dc input current, the same type of fuse with a lower rating can be used. Refer to the fuse manufacturer's data sheet for further information.

Electrical Specifications (continued)

| Parameter | Device | Symbol | Min | Typ | Max | Unit |
|---|--|--|-------------|--|-----------------|--|
| Output Voltage Set-point ($V_{IN}=V_{N, min}$, $I_O=I_{O, max}$, $T_A=25^\circ\text{C}$) | All | $V_{O, set}$ | -1.2 | — | +1.2 | % $V_{O, set}$ |
| Output Voltage (Over all operating input voltage, resistive load, and temperature conditions until end of life) | All | $V_{O, set}$ | -3.0 | — | +3.0 | % $V_{O, set}$ |
| Adjustment Range Selected by an external resistor | All | V_O | 0.7887 | | 5.5 | Vdc |
| Output Regulation Line ($V_{IN}=V_{IN, min}$ to $V_{IN, max}$) Load ($I_O=I_{O, min}$ to $I_{O, max}$) Temperature ($T_{ref}=T_{A, min}$ to $T_{A, max}$) | All All All | | — — — | 0.01 0.1 0.5 | 0.1 0.2 1 | % $V_{O, set}$ % $V_{O, set}$ % $V_{O, set}$ |
| Output Ripple and Noise on nominal output ($V_{IN}=V_{IN, nom}$ and $I_O=I_{O, min}$ to $I_{O, max}$ $C_{out} = 2 * 0.47\mu\text{F}$ ceramic capacitors) | | | | | | |
| RMS (5Hz to 20MHz bandwidth) | All | | — | 5 | 15 | mV _{rms} |
| Peak-to-Peak (5Hz to 20MHz bandwidth) | All | | — | 15 | 50 | mV _{pk-pk} |
| External Capacitance ESR $\geq 1 \text{ m}\Omega$ ESR $\geq 10 \text{ m}\Omega$ | All All | $C_{O, max}$ $C_{O, max}$ | — — | — — | 1000 10,000 | μF μF |
| Output Current | All | I_O | 0 | | 25 | Adc |
| Output Current Limit Inception (Hiccup Mode) | All | $I_{O, lim}$ | — | 125 | 150 | % I_O |
| Output Short-Circuit Current ($V_O \leq 250\text{mV}$) (Hiccup Mode) | All | $I_{O, s/c}$ | — | 1 | — | Adc |
| Efficiency $V_{IN} = V_{IN, nom}$, $T_A=25^\circ\text{C}$ $I_O=I_{O, max}$, $V_O = V_{O, set}$ | $V_{O, set} = 0.8\text{Vdc}$ $V_{O, set} = 1.2\text{Vdc}$ $V_{O, set} = 1.5\text{Vdc}$ $V_{O, set} = 1.8\text{Vdc}$ $V_{O, set} = 2.0\text{Vdc}$ $V_{O, set} = 2.5\text{Vdc}$ $V_{O, set} = 3.3\text{Vdc}$ $V_{O, set} = 5.5\text{Vdc}$ | η η η η η η η η | | 79.0 84.7 87.3 88.9 89.7 91.4 93.1 95.1 | | % % % % % % % % |
| Switching Frequency | All | f_{sw} | — | 500 | — | kHz |
| Dynamic Load Response ($dI_O/dt=5\text{A}/\mu\text{s}$; $V_{IN} = V_{IN, nom}$; $T_A=25^\circ\text{C}$) Load Change from $I_O= 50\%$ to 100% of $I_{O, max}$; No external output capacitors Peak Deviation Settling Time ($V_O < 10\%$ peak deviation) | All All | V_{pk} t_s | — — | 25 | 150 | mV μs |
| ($dI_O/dt=5\text{A}/\mu\text{s}$; $V_{IN} = V_{IN, nom}$; $T_A=25^\circ\text{C}$) Load Change from $I_O= 100\%$ to 50% of $I_{O, max}$: No external output capacitors Peak Deviation Settling Time ($V_O < 10\%$ peak deviation) | All All | V_{pk} t_s | — — | 25 | 150 | mV μs |

General Specifications

| Parameter | Min | Typ | Max | Unit |
|---|-----|-------------|-----|---------|
| Calculated MTBF ($I_o=80\%$ of $I_{o, max}$, $T_A=25^\circ\text{C}$) | | 2,150,000 | | Hours |
| Weight | — | 15.5 (0.55) | — | g (oz.) |

Feature Specifications

Unless otherwise indicated, specifications apply over all operating input voltage, resistive load, and temperature conditions. See Feature Descriptions for additional information.

| Parameter | Device | Symbol | Min | Typ | Max | Unit |
|--|--------|---------------|------|-----|------|------------------|
| SEQ/ENA Signal Interface ($V_{IN}=V_{IN, min}$ to $V_{IN, max}$; open collector or equivalent, Signal referenced to GND) | | | | | | |
| Logic High (SEQ/ENA pin open – Module Off) | | | | | | |
| SEQ/ENA Current | All | $I_{SEQ/ENA}$ | 0.5 | — | 2.33 | mA |
| SEQ/ENA Voltage: | All | $V_{SEQ/ENA}$ | 3.5 | — | 14 | V |
| Logic Low (Module ON) | | | | | | |
| SEQ/ENA Current: | All | $I_{SEQ/ENA}$ | — | — | 200 | μA |
| SEQ/ENA Voltage: | All | $V_{SEQ/ENA}$ | — | — | 1.2 | V |
| Turn-On Delay and Rise Times ($I_o=I_{o, max}$, V_o to within $\pm 1\%$ of steady state) | | | | | | |
| | All | Tdelay | — | 1 | — | msec |
| | All | Trise | — | 5 | — | msec |
| Output voltage overshoot – Startup $I_o=80\%$ of $I_{o, max}$; $V_{IN} = 12\text{Vdc}$, $T_A = 25^\circ\text{C}$ | | | | | | |
| | | | | 0.1 | 0.5 | % $V_{O, set}$ |
| Output Overvoltage Protection (Latching) | | | | | | |
| | All | | 5.62 | 5.8 | 6.0 | V |
| Input Undervoltage Lockout | | | | | | |
| Turn-on Threshold | All | | | | 9.9 | V |
| Turn-off Threshold | All | | 8.1 | | | V |
| Remote Sense Range | | | | | | |
| | | | — | — | 0.5 | V |
| Overtemperature Protection (See Thermal Consideration section) | | | | | | |
| | All | T_{ref} | — | 125 | — | $^\circ\text{C}$ |
| Forced Load Share Accuracy | | | | | | |
| | All | | — | 10 | | % I_o |
| Number of units in Parallel | | | | | | |
| | | | | | 5 | |

Characteristic Curves

The following figures provide typical characteristics for the NXA025A0X –S at 25°C.

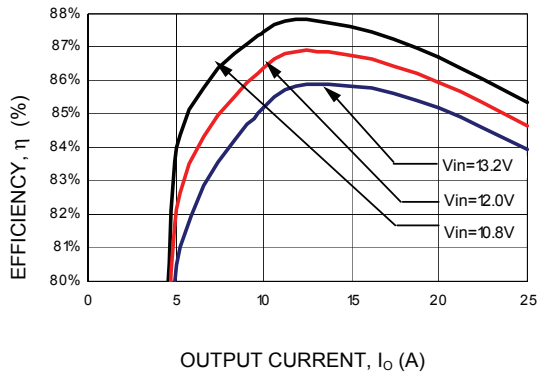

Figure 1. Converter Efficiency versus Output Current (Vout = 1.2Vdc).

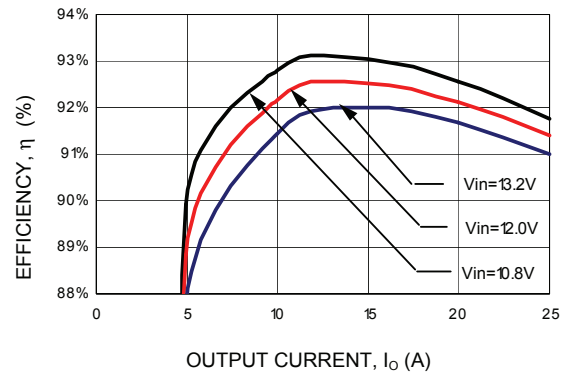

Figure 4. Converter Efficiency versus Output Current (Vout = 2.5Vdc).

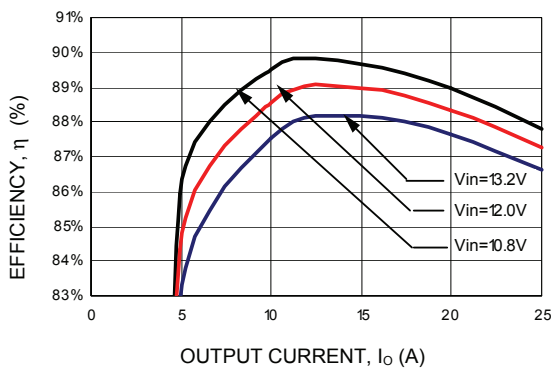

Figure 2. Converter Efficiency versus Output Current (Vout = 1.5Vdc).

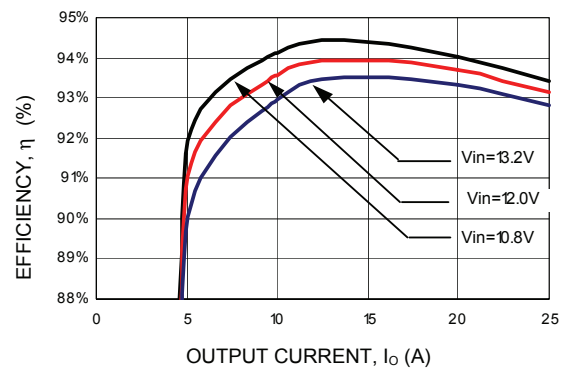

Figure 5. Converter Efficiency versus Output Current (Vout = 3.3Vdc).

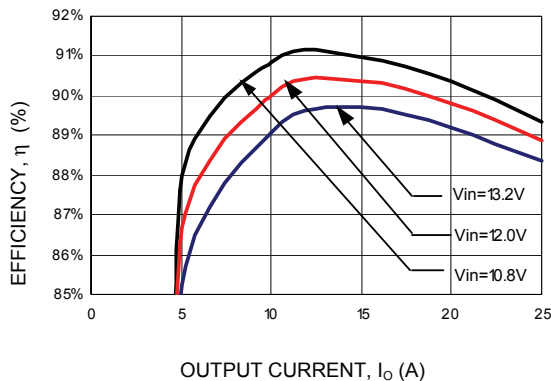

Figure 3. Converter Efficiency versus Output Current (Vout = 1.8Vdc).

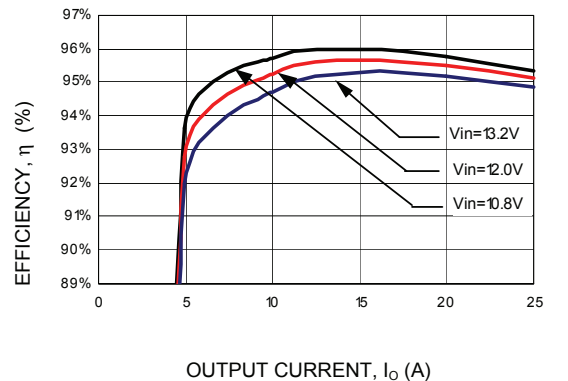

Figure 6. Converter Efficiency versus Output Current (Vout = 5.0Vdc).

Characteristic Curves (continued)

The following figures provide typical characteristics for the NXA025A0X –S at 25°C.

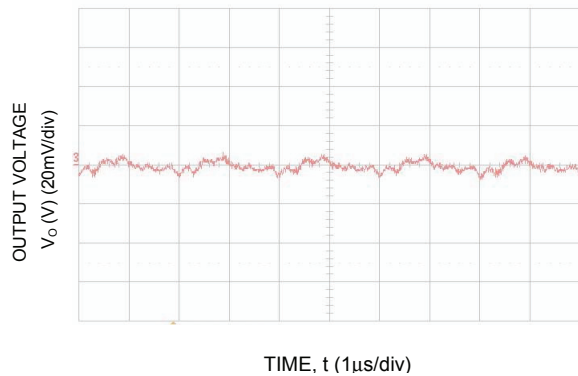

Figure 7. Typical Output Ripple and Noise ($V_{in} = 12V$ dc, $V_o = 3.3V$ dc, $C_{out} = 2x 0.47\mu F$ ceramic capacitor).

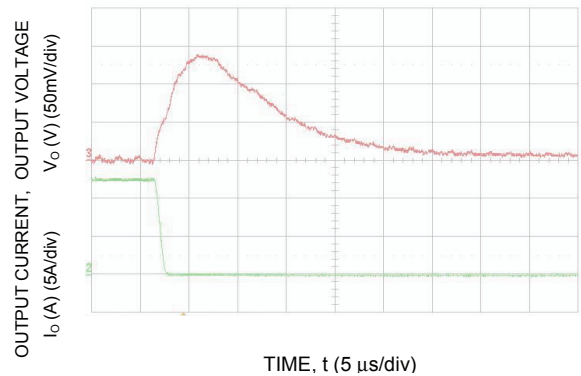

Figure 10. Transient Response to Dynamic Load Change from 100% to 50% of full load ($V_o = 3.3V$ dc).

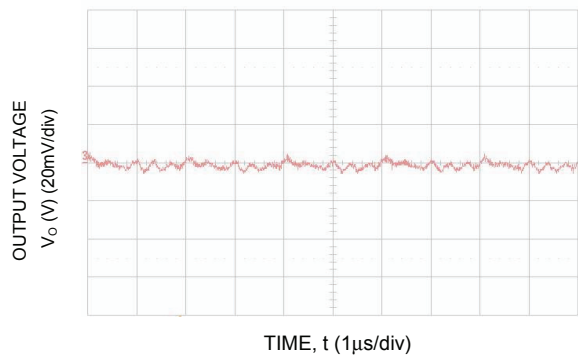

Figure 8. Typical Output Ripple and Noise ($V_{in} = 12V$ dc, $V_o = 1.2V$ dc, $C_{out} = 2x 0.47\mu F$ ceramic capacitor).

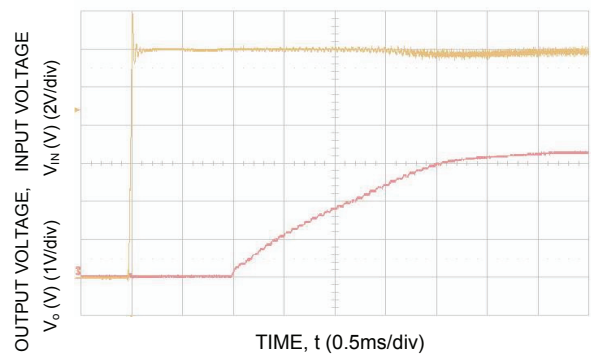

Figure 11. Typical Start-Up with application of V_{in} ($V_o = 3.3V$ dc).

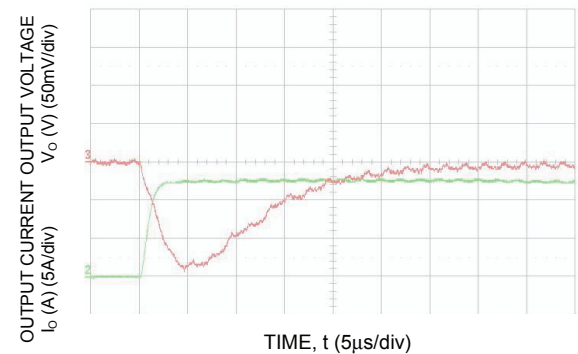

Figure 9. Transient Response to Dynamic Load Change from 50% to 100% of full load ($V_o = 3.3V$ dc).

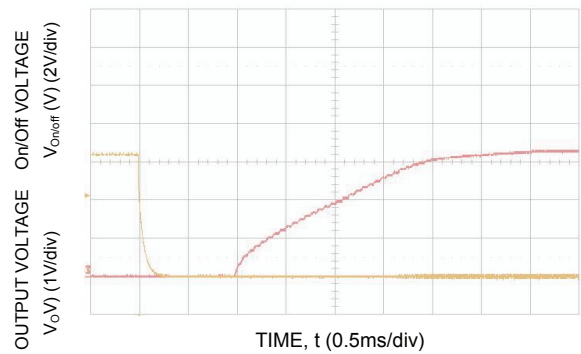

Figure 12. Typical Start-Up Using Enable ($V_o = 3.3V$ dc).

Characteristic Curves (continued)

The following figures provide typical characteristics for the NXA025A0X –S at 25°C.

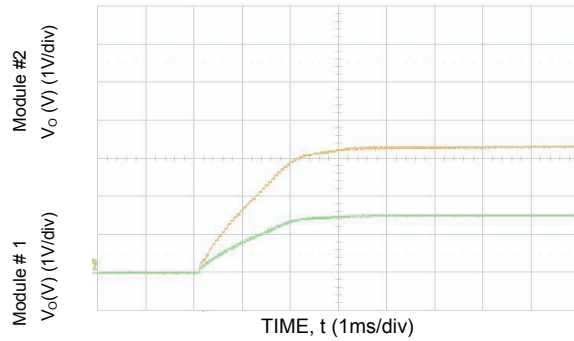

Figure 13. Synchronized Start-up of Output Voltage when SEQ/ENA pins are tied together (Module #1 = 1.5Vdc, Module #2 = 3.3Vdc).

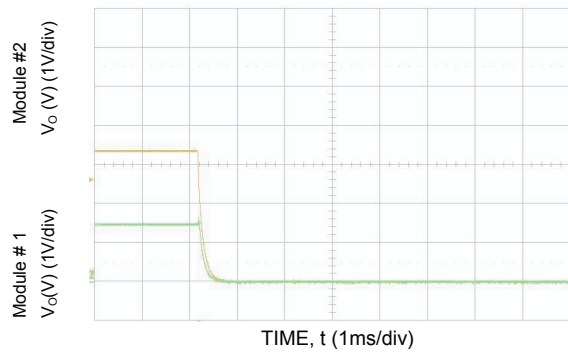

Figure 14. Synchronized Shut-down of Output Voltage when SEQ/ENA pins are tied together (Module #1 = 1.5Vdc, Module #2 = 3.3Vdc).

Characteristic Curves (continued)

The following figures provide typical thermal derating curves for NXA025A0X –S (Figures 19 and 20 show derating curves with base plate).

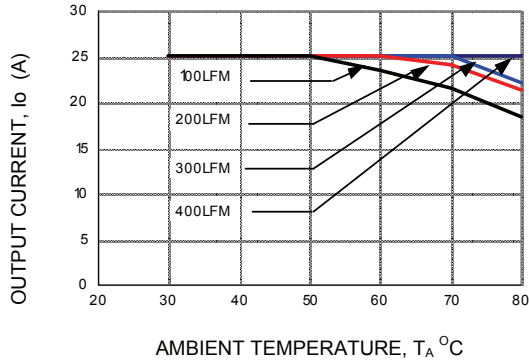

Figure 15. Derating Output Current versus Local Ambient Temperature and Airflow ($V_{in} = 12Vdc$, $V_o=1.2Vdc$).

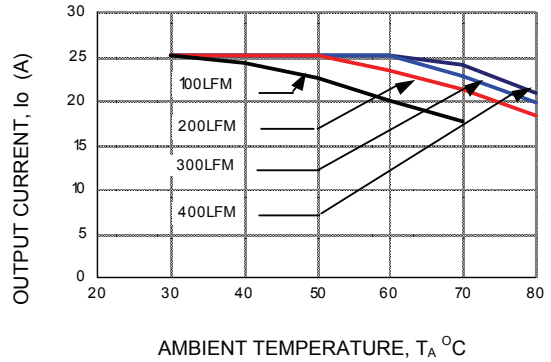

Figure 18. Derating Output Current versus Local Ambient Temperature and Airflow ($V_{in} = 12Vdc$, $V_o=5.0 Vdc$).

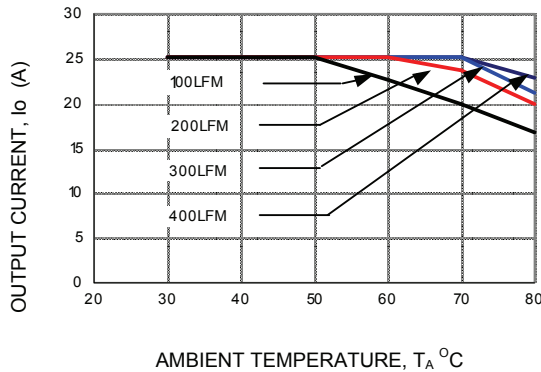

Figure 16. Derating Output Current versus Local Ambient Temperature and Airflow ($V_{in} = 12Vdc$, $V_o=1.8 Vdc$).

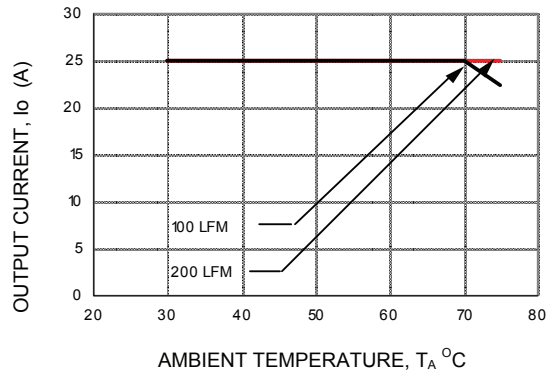

Figure 19. Derating Output Current versus Local Ambient Temperature and Airflow ($V_{in} = 12Vdc$, $V_o=3.3 Vdc$) with baseplate.

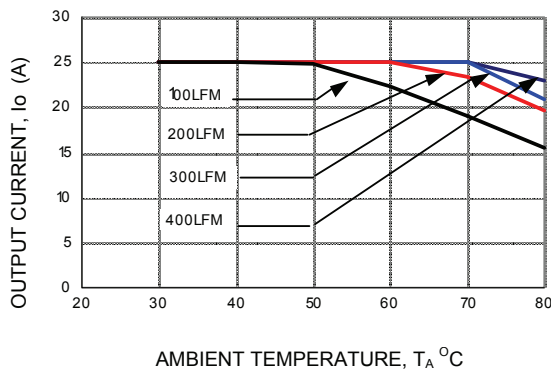

Figure 17. Derating Output Current versus Local Ambient Temperature and Airflow ($V_{in} = 12Vdc$, $V_o=3.3 Vdc$).

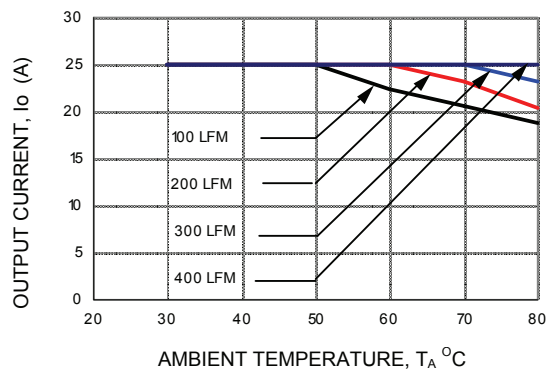

Figure 20. Derating Output Current versus Local Ambient Temperature and Airflow ($V_{in} = 12Vdc$, $V_o=5.0 Vdc$) with baseplate.

Test Configurations

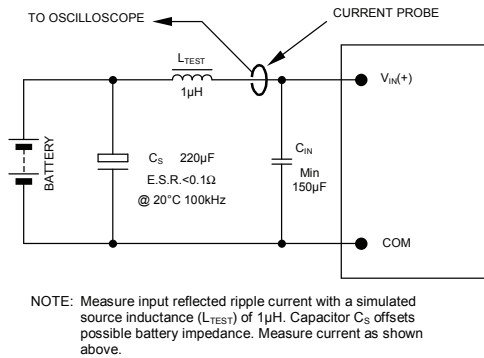

Figure 21. Input Reflected Ripple Current Test Setup.

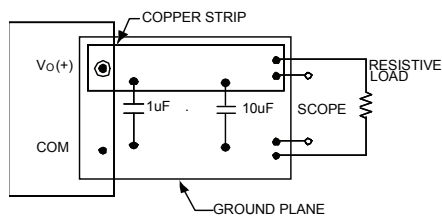

Figure 22. Output Ripple and Noise Test Setup.

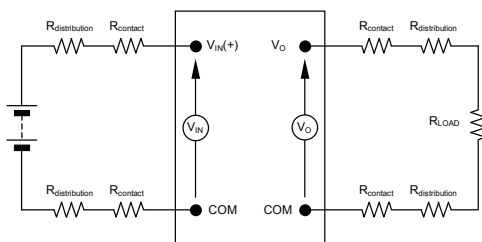

Figure 23. Output Voltage and Efficiency Test Setup.

$$\text{Efficiency } \eta = \frac{V_O \cdot I_O}{V_{IN} \cdot I_{IN}} \times 100 \%$$

Typical Application Circuit

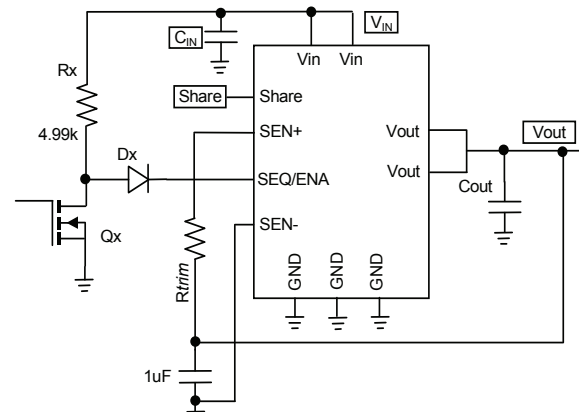

Figure 24. Application Schematic

Design Considerations

Input Source Impedance

The power module should be connected to a low-impedance source. Highly inductive source impedance can affect the stability of the power module. The input capacitor C_{IN} should be located equal distance from the two input pins of the module. C_{IN} is recommended to be 150µF minimum. The ripple voltage is 50mV RMS at 1MHz and the capacitor should be chosen with an ESR and an RMS Current Rating for this amount of ripple voltage. When using multiple modules in parallel, a small inductor (0.2 – 0.5µH) is recommended at the input of each module to prevent interaction between modules. Consult the factory for further application guidelines.

Safety Considerations

For safety agency approval the power module must be installed in compliance with the spacing and separation requirements of the end-use safety agency standards, i.e., UL 60950-1, CSA C22.2 No. 60950-1-03, and VDE 0850:2001-12 (EN60950-1) Licensed.

For the converter output to be considered meeting the requirements of safety extra-low voltage (SELV), the input must meet SELV requirements. The power module has extra-low voltage (ELV) outputs when all inputs are ELV.

The input to these units is to be provided with a maximum of 30 A fast-acting fuse in the ungrounded lead.

Feature Description

Remote On/Off using SEQ/ENA Pin

The NXA025A0X-S SMT power modules feature an SEQ/ENA pin for remote On/Off operation. If not using the remote On/Off pin, leave the pin open (module will be on). The SEQ/ENA signal ($V_{SEQ/ENA}$) is referenced to ground. Circuit configuration for remote On/Off operation of the module using SEQ/ENA pin is shown in Figure 25.

During Logic High on the SEQ/ENA pin (transistor Qx is OFF), the module remains OFF. The external resistor Rx should be chosen to maintain 3.5V minimum on the SEQ/ENA pin to insure that the unit is OFF when transistor Qx is in the OFF state. During Logic-Low when Qx is turned ON, the module is turned ON. Note that the external diode is required to make sure the internal thermal shutdown (THERMAL_SD) and undervoltage (UVLO) circuits are not disabled when Qx is turned ON

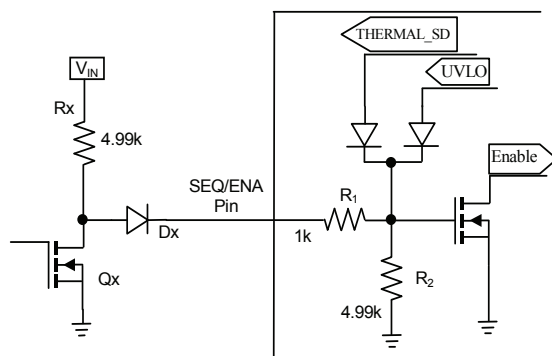

Figure 25. Remote On/Off Implementation.

The SEQ/ENA pin can also be used to synchronize the output voltage start-up and shutdown of multiple modules in parallel. By connecting SEQ/ENA pins of multiple modules, the output start-up can be synchronized (please refer to characterization curves). When SEQ/ENA pins are connected together, all modules will shutdown if any one of the modules gets disabled due to undervoltage lockout or overtemperature protection.

Remote Sense

Remote sense feature minimizes the effects of distribution losses by regulating the voltage at the remote sense pins. The voltage between the remote sense pins and the output terminals must not exceed the remote sense range given in the Feature Specification table, i.e.:

$$[V_{O(+)} - V_{O(GND)}] - [SENSE(+)- SENSE(-)] < 0.5V$$

Remote sense configuration is shown in Figure 26. If not using the remote sense feature to regulate the output

voltage at the point of load, connect SENSE (+) to $V_{O(+)}$ and Sense (-) to ground. The amount of power delivered by the module is defined as the voltage at the output terminals multiplied by the output current. When using the remote sense, the output voltage of the module can be increased, which at the same output current would increase the power output of the module. Ensure that the maximum output power of the module remains at or below the maximum rated power ($P_{o,max} = I_{o,max} \times V_{o,max}$).

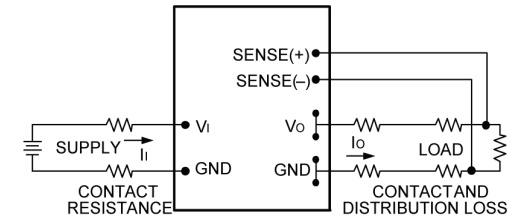

Figure 26. Effective Circuit Configuration for Remote sense operation

Overcurrent Protection

To provide protection in a fault (output overload) condition, the unit is equipped with internal current-limiting circuitry and can endure current limiting continuously. At the point of current-limit inception, the unit enters hiccup mode. The unit operates normally once the output current is brought back into its specified range. The average output current during hiccup is 10% $I_{o,max}$.

Input Undervoltage Lockout

At input voltages below the input undervoltage lockout limit, module operation is disabled. The module will begin to operate at an input voltage above the undervoltage lockout turn-on threshold.

Overtemperature Protection

To provide protection in a fault condition, the unit is equipped with a thermal shutdown circuit. The unit will shutdown if the thermal reference point T_{ref} , exceeds 125°C (typical), but the thermal shutdown is not intended as a guarantee that the unit will survive temperatures beyond its rating. The module will automatically restarts after it cools down.

Output Voltage Programming

The output voltage of the NXA025A0X-S can be programmed to any voltage from 0.8Vdc to 5.5Vdc by inserting a series resistor (shown as R_{trim} in figure 27) in the Sense(+) pin of the module. Without an external resistor in the Sense(+) pin (Sense (+) pin is shorted to $V_{O(+)}$), the output voltage of the module will be 0.7887V. With Sense(+) not connected to $V_{O(+)}$, the output of the module will reach overvoltage shutdown. A 1μF multi-layer ceramic capacitor is required from R_{trim} to Sense(-) pin to minimize noise. To calculate the value of the

Feature Descriptions (continued)

Output Voltage Programming (continued)

resistor R_{trim} for a particular desired voltage V_o , use the following equation:

$$R_{trim} = 775 * \left[\frac{V_o}{0.7887} - 1 \right] \Omega$$

Where V_o is the desired output voltage and R_{trim} is the external resistor in ohms

For example, to program the output voltage of the NXA025A0X-S module to 2.5Vdc, R_{trim} is calculated as follows:

$$R_{trim} = 775 * \left[\frac{2.5}{0.7887} - 1 \right]$$

$$R_{trim} = 1682\Omega$$

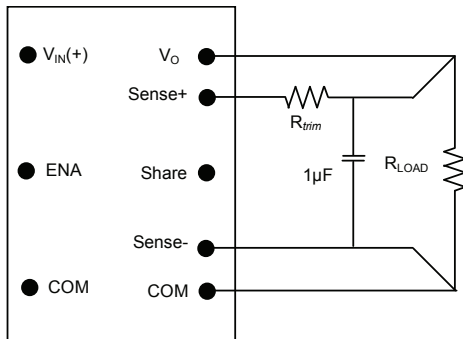

Figure 27. Circuit Configuration for Programming Output voltage

Table 1 provides R_{trim} values required for most common output voltages. To achieve the output voltage tolerance as specified in the electrical specifications over all operating input voltage, resistive load and temperature conditions, use 0.1% thick metal film resistor.

Table 1

| $V_{o,set}$ (V) | R_{trim} Ω |
|----------------------|------------------------|
| 0.8 | 11 |
| 1.0 | 208 |
| 1.2 | 404 |
| 1.5 | 699 |
| 1.8 | 994 |
| 2.0 | 1190 |
| 2.5 | 1682 |
| 3.3 | 2468 |
| 5.0 | 4138 |
| Overvoltage Shutdown | Open |

Forced Load sharing (Parallel Operation)

For additional power requirements, the power module can be configured for parallel operation with forced load sharing (See Figure 28). Good layout techniques should be observed for noise immunity when using multiple units in parallel. To implement forced load sharing, the following connections should be made:

- The share pins of all units in parallel must be connected together. The path of these connections should be as direct as possible.
- All remote-sense pins should be connected to the power bus at the same point, i.e., connect all the SENSE(+) pins to the (+) side of the bus and all the SENSE(-) pins to the GROUND of the power bus at the same point. Close proximity and directness are necessary for good noise immunity

The share bus is not designed for redundant operation and the system will be non-functional upon failure of one of the unit when multiple units are in parallel. The maximum number of modules tied to share bus is 5. When not using the parallel feature, leave the share pin open.

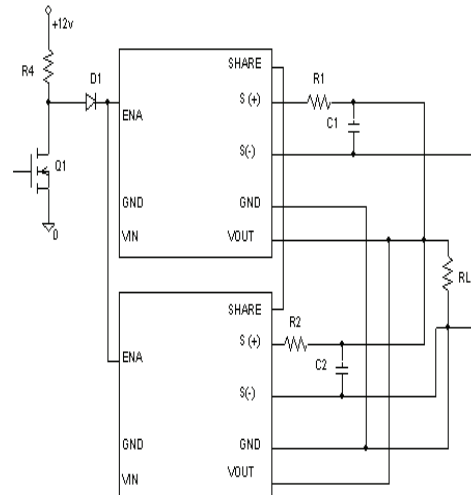

Figure 28. Circuit Configuration for modules in parallel.

Thermal Considerations

The power modules operate in a variety of thermal environments; however, sufficient cooling should be provided to help ensure reliable operation.

Considerations include ambient temperature, airflow, module power dissipation, and the need for increased reliability. A reduction in the operating temperature of the module will result in an increase in reliability. The thermal data presented here is based on physical measurements taken in a wind tunnel.

The thermal reference point, T_{ref} used in the specifications is shown in Figure 29. For reliable operation this temperature should not exceed 110°C.

Please refer to the Application Note “Thermal Characterization Process For Open-Frame Board-Mounted Power Modules” for a detailed discussion of thermal aspects including maximum device temperatures.

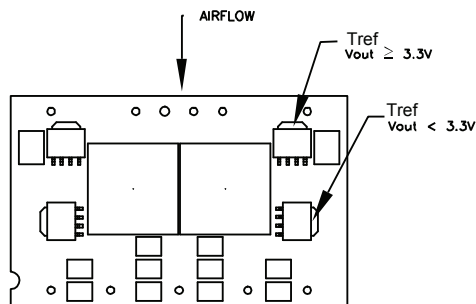

Figure 29. T_{ref} Temperature measurement location.

reliable operation this temperature should not exceed 105°C.

Layout Considerations

The input capacitors should be located equal distance from the two input pins of the module. Recommended layout is shown in the mechanical section. In addition to the input and output planes, a ground plane beneath the module is recommended.

Heat Transfer via Convection

Increased airflow over the module enhances the heat transfer via convection. Derating figures showing the maximum output current that can be delivered by various module versus local ambient temperature (T_A) for natural convection and up to 2m/s (400 ft./min) are shown in the respective Characteristics Curves section.

Base-Plate option (-H)

The baseplate option (-H) power modules are constructed with baseplate on topside of the open frame power module. The baseplate includes two through-threaded, M3 x 0.5 mounting hole pattern, which enable heat sinks or cold plates to attach to the module. The mounting torque must not exceed 0.56 N-m (5 in.-lb.) during heat sink assembly. The baseplate option allows customers to operate the module in an extreme thermal environment with attachment of heatsink/cold-plate for proper cooling of internal component to heighten reliable and consistent operation. The thermal reference point for baseplate option is center of the heat plate on the top-side. For

Mechanical Outline for NXA025A0X-S

Dimensions are in millimeters and (inches).

Tolerances: x.x mm ± 0.5 mm (x.xx in. ± 0.02 in.) [unless otherwise indicated]

x.xx mm ± 0.25 mm (x.xxx in ± 0.010 in.)

Top View

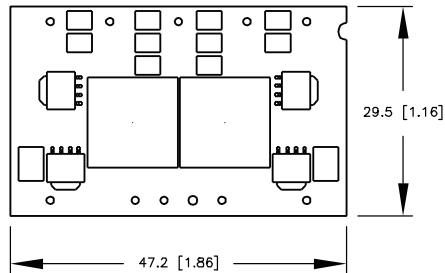

Side View

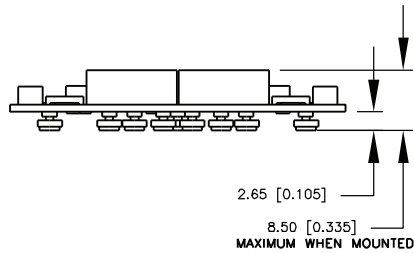

Bottom View

| Pin # | Function |
|-------|----------|
| 1 | Ground |
| 2 | Vout |
| 3 | Ground |
| 4 | Vout |
| 5 | Ground |
| 6 | Vin |
| 7 | SHARE |
| 8 | Sen+ |
| 9 | SEQ/ENA |
| 10 | Sen- |
| 11 | Vin |

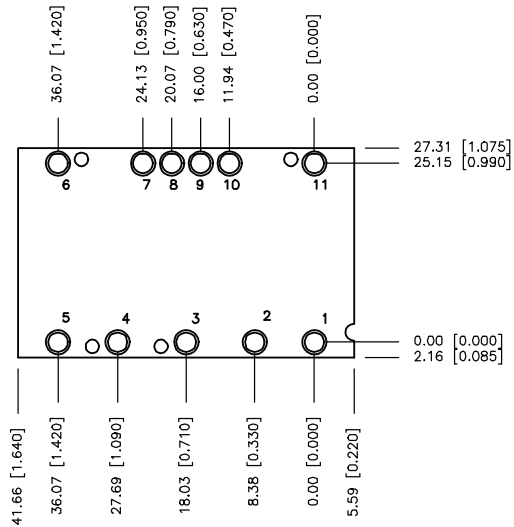

Mechanical Outline for NXA025A0X-HS

Dimensions are in millimeters and (inches).

Tolerances: x.x mm ± 0.5 mm (x.xx in. ± 0.02 in.) [unless otherwise indicated]

x.xx mm ± 0.25 mm (x.xxx in ± 0.010 in.)

Top View

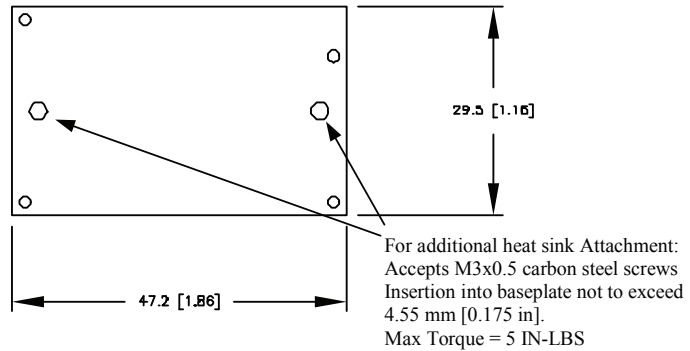

Side View

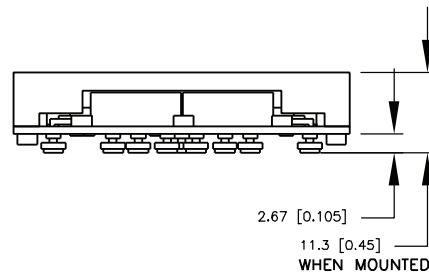

Bottom View

| Pin # | Function |
|-------|----------|
| 1 | Ground |
| 2 | Vout |
| 3 | Ground |
| 4 | Vout |
| 5 | Ground |
| 6 | Vin |
| 7 | SHARE |
| 8 | Sen+ |
| 9 | SEQ/ENA |
| 10 | Sen- |
| 11 | Vin |

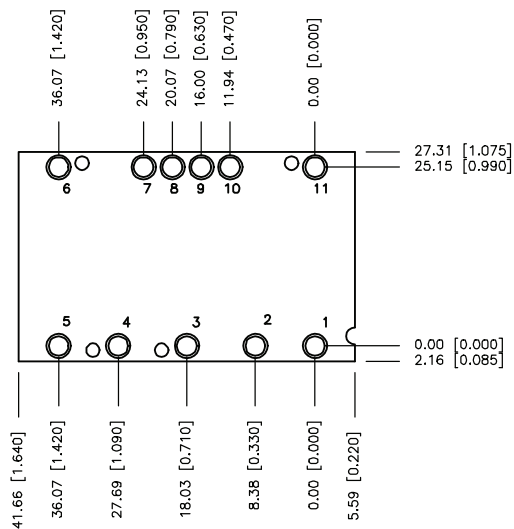

Recommended Pad Layout

Dimensions are in millimeters and inches.

Tolerances: x.x mm ± 0.5 mm (x.xx in. ± 0.02 in.) [unless otherwise indicated]

x.xx mm ± 0.25 mm (x.xxx in ± 0.010 in.)

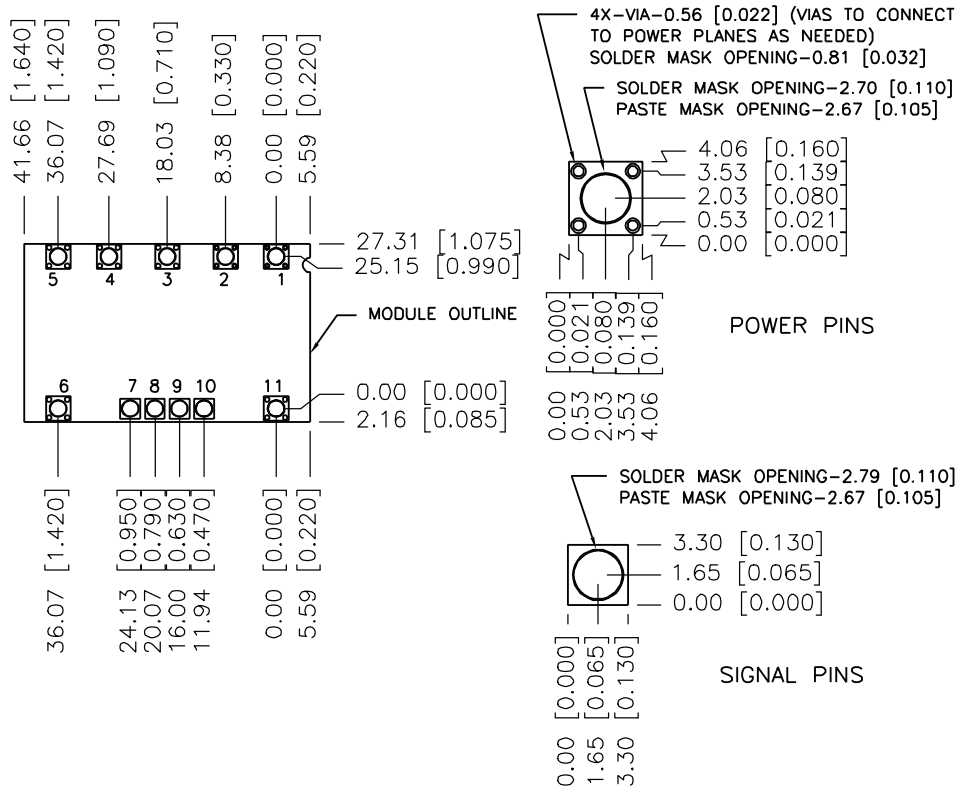

Layout Guidelines

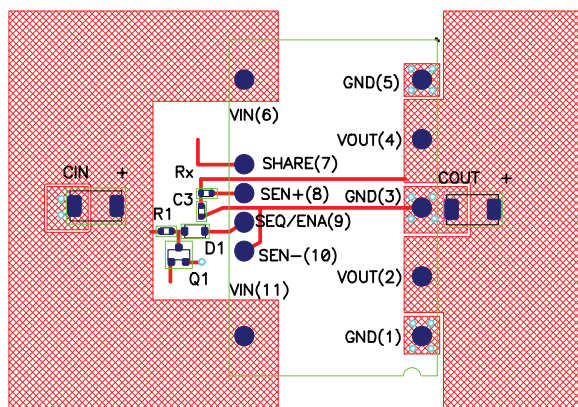

Mechanical Outline for NXA025A0X-L

Dimensions are in millimeters and (inches).

Tolerances: x.x mm ± 0.5 mm (x.xx in. ± 0.02 in.) [unless otherwise indicated]

x.xx mm ± 0.25 mm (x.xxx in ± 0.010 in.)

Top View

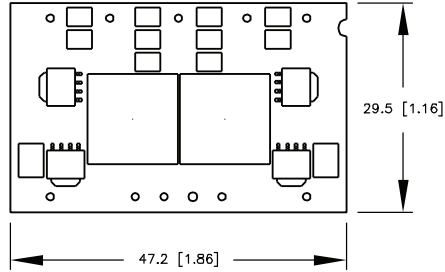

Side View

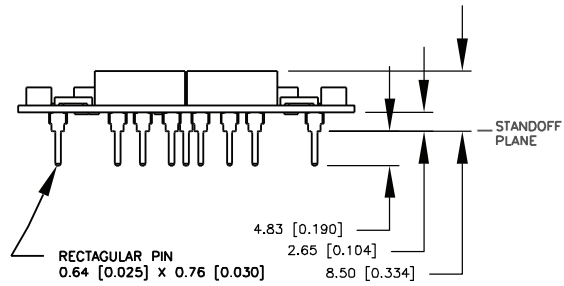

Bottom View

| Pin # | Function |
|-------|----------|
| 1 | Ground |
| 2 | Vout |
| 3 | Ground |
| 4 | Vout |
| 5 | Ground |
| 6 | Vin |
| 7 | SHARE |
| 8 | Sen+ |
| 9 | SEQ/ENA |
| 10 | Sen- |
| 11 | Vin |

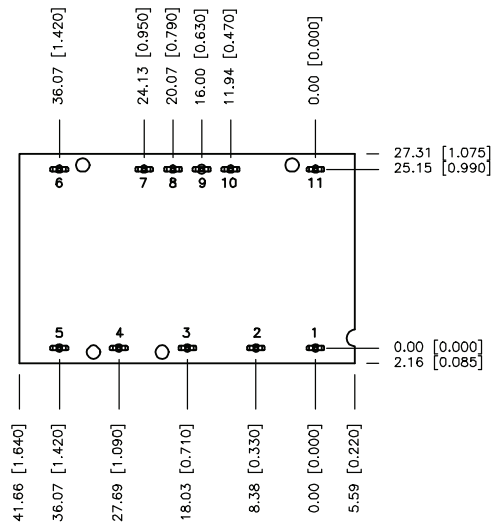

Recommended Pad Layout for NXA025A0X-L (Through Hole Version)

Dimensions are in millimeters and (inches).

Tolerances: x.x mm ± 0.5 mm (x.xx in. ± 0.02 in.) [unless otherwise indicated]

x.xx mm ± 0.25 mm (x.xxx in ± 0.010 in.)

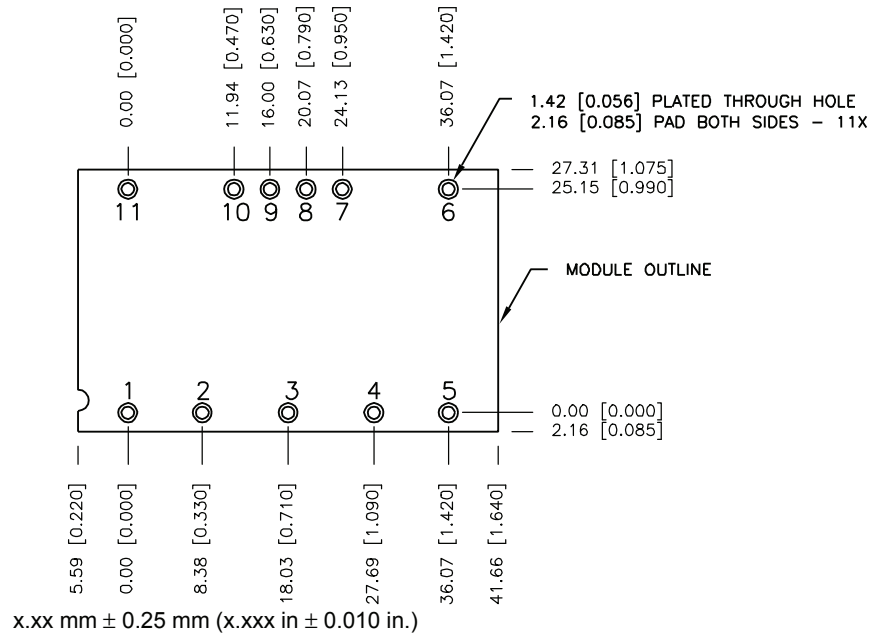

Surface Mount Information

Packaging Details

The surface mount versions of the NXA025-S series modules are supplied as standard in the plastic tray shown in Figure 30. The tray has external dimensions of 136mm (W) x 322.6mm (L) x 18.4mm (H) or 5.35in (W) x 12.7in (L) x 0.72in (H).

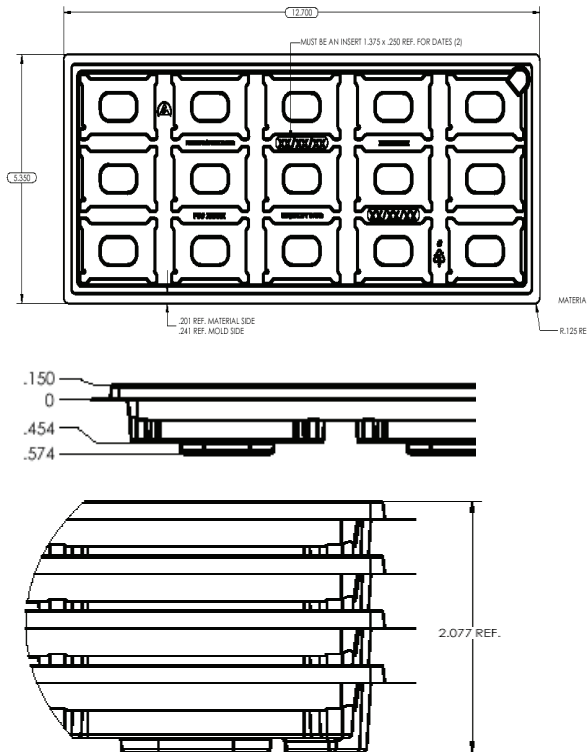

Figure 30. Surface Mount Packaging Tray

Tray Specification

| | |
|-------------------------|-------------------------------|
| Material | Antistatic coated PVC |
| Max temperature | 65°C |
| Max surface resistivity | 10 ¹² Ω/sq |
| Color | Clear |
| Capacity | 15 power modules |
| Min order quantity | 45 pcs (1box of 3 full trays) |

Each tray contains a total of 15 power modules. The trays are self-stacking and each shipping box will contain 3 full trays plus one empty hold down tray giving a total number of 45 power modules.

Pick and Place

The NXA025-S series of DC-to-DC power modules use an open-frame construction and are designed for surface mount assembly within a fully automated manufacturing process.

The NXA025-S series modules are fitted with two Kapton labels designed to provide a large flat surface for pick and placing. The labels are located covering the Center of Gravity of the power module. The labels meet all the requirements for surface-mount processing, as well as meeting UL safety agency standards. The labels will withstand reflow temperatures up to 300°C. The labels also carry product information such as product code, date and location of manufacture. One of the two labels may be used as a pick-and-place location.

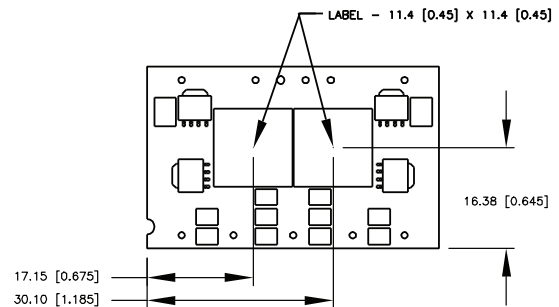

Figure 31. Pick and Place Location.

Nozzle Recommendations

The module weight has been kept to a minimum by using open frame construction. Even so, they have a relatively large mass when compared with conventional SMT components. Variables such as nozzle size, tip style, vacuum pressure and placement speed should be considered to optimize this process. The minimum recommended nozzle diameter for reliable operation is 6mm. The maximum nozzle outer diameter, which will safely fit within the allowable component spacing, is 9 mm.

Oblong or oval nozzles up to 11 x 9 mm may also be used within the space available.

For further information please contact your local Lineage Power technical representative.

Surface Mount Information (continued)

Reflow Soldering Information

These NXA025series power modules are large mass, low thermal resistance devices and typically heat up slower than other SMT components. It is recommended that the customer review data sheets in order to customize the solder reflow profile for each application board assembly.

The following instructions must be observed when SMT soldering these units. Failure to observe these instructions may result in the failure of or cause damage to the modules, and can adversely affect long-term reliability.

These surface mountable modules use our newest SMT technology called “Column Pin” (CP) connectors. Fig 32 shows the new CP connector before and after reflow soldering onto the end-board assembly.

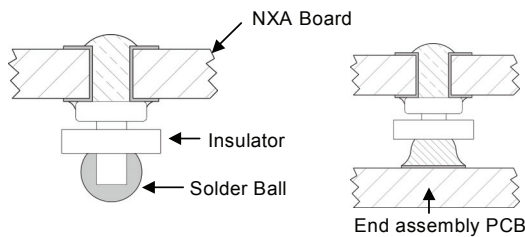

Figure 32. Column Pin Connector Before and After Reflow Soldering.

The CP is constructed from a solid copper pin with an integral solder ball attached, which is composed of tin/lead (Sn/Pb) solder. The CP connector design is able to compensate for large amounts of co-planarity and still ensure a reliable SMT solder joint.

Typically, the eutectic solder melts at 183°C, wets the land, and subsequently wicks the device connection. Sufficient time must be allowed to fuse the plating on the connection to ensure a reliable solder joint. There are several types of SMT reflow technologies currently used in the industry. These surface mount power modules can be reliably soldered using natural forced convection, IR (radiant infrared), or a combination of convection/IR. For reliable soldering the solder reflow profile should be established by accurately measuring the modules CP connector temperatures.

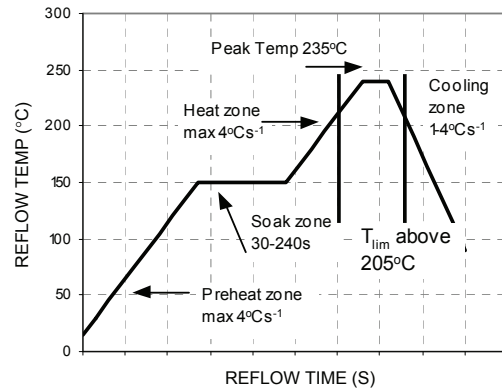

Figure 32. Recommended Reflow Profile.

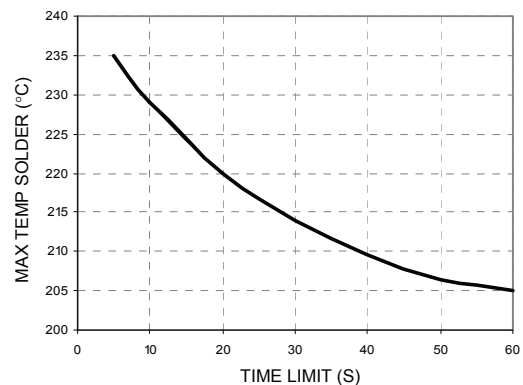

Figure 33. Time Limit Curve Above 205°C Reflow.

Surface Mount Information (continued)

Lead Free Soldering

The –Z version Naos SMT modules are lead-free (Pb-free) and RoHS compliant and are both forward and backward compatible in a Pb-free and a SnPb soldering process. Failure to observe the instructions below may result in the failure of or cause damage to the modules and can adversely affect long-term reliability.

Pb-free Reflow Profile

Power Systems will comply with J-STD-020 Rev. C (Moisture/Reflow Sensitivity Classification for Nonhermetic Solid State Surface Mount Devices) for both Pb-free solder profiles and MSL classification procedures. This standard provides a recommended forced-air-convection reflow profile based on the volume and thickness of the package (table 4-2). The suggested Pb-free solder paste is Sn/Ag/Cu (SAC). The recommended linear reflow profile using Sn/Ag/Cu solder is shown in Fig. 34.

MSL Rating

The Naos SMT modules have a MSL rating of 3.

Storage and Handling

The recommended storage environment and handling procedures for moisture-sensitive surface mount packages is detailed in J-STD-033 Rev. A (Handling, Packing, Shipping and Use of Moisture/Reflow Sensitive Surface Mount Devices). Moisture barrier bags (MBB) with desiccant are required for MSL ratings of 2 or greater. These sealed packages should not be broken until time of use. Once the original package is broken, the floor life of the product at conditions of $\leq 30^{\circ}\text{C}$ and 60% relative humidity varies according to the MSL rating (see J-STD-033A). The shelf life for dry packed SMT packages will be a minimum of 12 months from the bag seal date, when stored at the following conditions: $< 40^{\circ}\text{C}$, $< 90\%$ relative humidity.

Post Solder Cleaning and Drying Considerations

Post solder cleaning is usually the final circuit-board assembly process prior to electrical board testing. The result of inadequate cleaning and drying can affect both the reliability of a power module and the testability of the finished circuit-board assembly. For guidance on appropriate soldering, cleaning and drying procedures, refer to *Board Mounted Power Modules: Soldering and Cleaning Application Note* (AP01-056EPS).

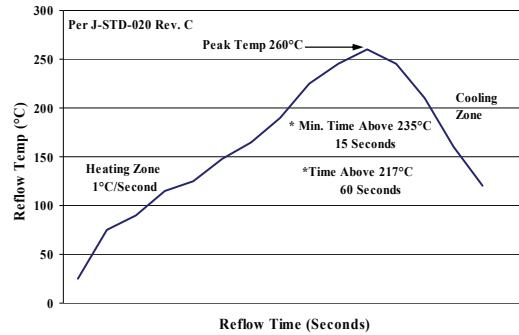

Figure 34. Recommended linear reflow profile using Sn/Ag/Cu solder.

Ordering Information

Please contact your Lineage Power Sales Representative for pricing, availability and optional features.

Table 2. Device Codes

| Product codes | Input Voltage | Output Voltage | Output Current | Efficiency 3.3V @ 25A | Connector Type | Comcodes |
|---------------|---------------|-----------------|----------------|-----------------------|----------------|-------------|
| NXA025A0X-S | 10 – 14 Vdc | 0.8Vdc – 5.5Vdc | 25 A | 93 % | SMT | 108975053 |
| NXA025A0X-HS | 10 – 14 Vdc | 0.8Vdc – 5.5Vdc | 25 A | 93 % | SMT | 108975061 |
| NXA025A0X-L | 10 – 14 Vdc | 0.8Vdc – 5.5Vdc | 25 A | 93 % | TH | 108988515 |
| NXA025A0X-LP | 10 – 14 Vdc | 0.8Vdc – 5.5Vdc | 25 A | 93 % | TH | CC109101350 |
| NXA025A0X-SP | 10 – 14 Vdc | 0.8Vdc – 5.5Vdc | 25 A | 93 % | SMT | CC109101342 |
| NXA025A0X-LPZ | 10 – 14 Vdc | 0.8Vdc – 5.5Vdc | 25 A | 93 % | TH | CC109106746 |
| NXA025A0X-SZ | 10 – 14 Vdc | 0.8Vdc – 5.5Vdc | 25 A | 93 % | SMT | 109100402 |
| NXA025A0X-HSZ | 10 – 14 Vdc | 0.8Vdc – 5.5Vdc | 25 A | 93 % | SMT | 109100393 |
| NXA025A0X-LZ | 10 – 14 Vdc | 0.8Vdc – 5.5Vdc | 25 A | 93 % | TH | CC109107174 |
| NXA025A0X-SPZ | 10 – 14 Vdc | 0.8Vdc – 5.5Vdc | 25 A | 93 % | SMT | CC109133682 |

-Z refers to RoHS-compliant versions.



LINEAGE POWER

World Wide Headquarters
Lineage Power Corporation
601 Shiloh Road, Plano, TX 75074, USA
+1-800-526-7819
(Outside U.S.A.: **+1-972-244-9428**)
www.lineagepower.com
e-mail: techsupport1@lineagepower.com

Asia-Pacific Headquarters
Tel: +65 6593 7211

Europe, Middle-East and Africa Headquarters
Tel: +49 898 780 672 80

India Headquarters
Tel: +91 80 28411633

Lineage Power reserves the right to make changes to the product(s) or information contained herein without notice. No liability is assumed as a result of their use or application. No rights under any patent accompany the sale of any such product(s) or information.

Lineage Power DC-DC products are protected under various patents. Information on these patents is available at www.lineagepower.com/patents.

© 2009 Lineage Power Corporation, (Plano, Texas) All International Rights Reserved.