

## Overview

The KEMET SS Coils, SS11VL Type AC line filters are offered in a wide variety of sizes and specifications.

## Applications

- Consumer Electronics
- Common mode choke

## Benefits

- Wide variety of sizes and specifications
- Super low profile: 20.5 mm maximum
- Inductances up to 82 mH
- Rated Currents up to 3 A
- DC Resistances as low as 0.06  $\Omega$



## Part Number System

SS	11	VL-	R	03	550
Series	Core Size (mm)	Core Orientation	Core Type	Rated Current (A)	Minimum Inductance (mH)
SS	11 = 11.0	VL- = Vertical	Blank = Standard R = High permeability	0x = 0.x A (e.g., 03 = 0.3 A) xx = x.x A (e.g., 13 = 1.3 A)	xx0 = xx mH (e.g., 550 = 55 mH) 0xx = x.x mH (e.g., 024 = 2.4 mH)

## Dimensions – Millimeters

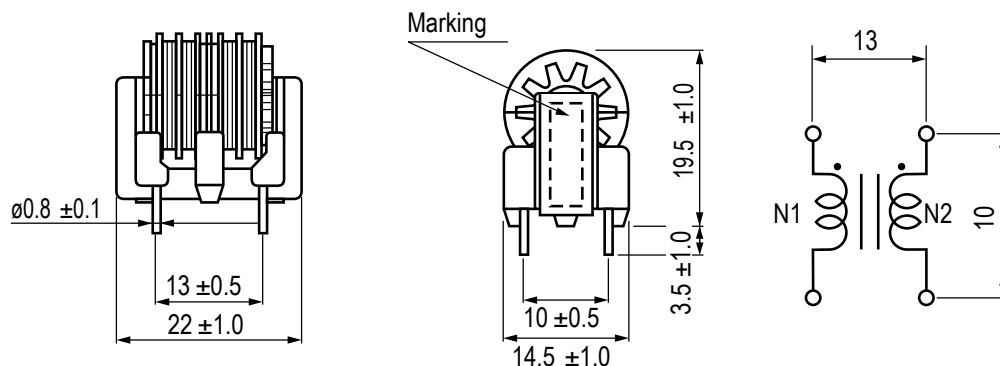

## Environmental Compliance

All KEMET AC Line Filters are RoHS Compliant.

**Table 1 – Ratings & Part Number Reference**

Part Number	Rated Current AC (A)	Inductance (mH) Minimum	DC Resistance/ Line (Ω) Maximum	Temperature Rise (K) Maximum	Marking	Weight (g) Approximate
SS11VL-03550	0.3	55	4.1	45	03 Lot No.	10.5
SS11VL-04350	0.4	35	2.6	45	04 Lot No.	10.7
SS11VL-05230	0.5	23	1.8	45	05 Lot No.	10.5
SS11VL-06180	0.6	18	1.3	45	06 Lot No.	11.1
SS11VL-07120	0.7	12	0.90	45	07 Lot No.	10.8
SS11VL-08083	0.8	8.3	0.74	45	08 Lot No.	9.8
SS11VL-10062	1.0	6.2	0.44	45	10 Lot No.	11.1
SS11VL-11050	1.1	5.0	0.40	45	11 Lot No.	10.7
SS11VL-13035	1.3	3.5	0.28	45	13 Lot No.	10.5
SS11VL-17024	1.7	2.4	0.19	45	17 Lot No.	10.8
SS11VL-22013	2.2	1.3	0.12	45	22 Lot No.	10.4
SS11VL-30006	3.0	0.6	0.06	45	30 Lot No.	9.6
SS11VL-R03820	0.3	82	4.1	45	R03 Lot No.	10.5
SS11VL-R04520	0.4	52	2.6	45	R04 Lot No.	10.7
SS11VL-R05350	0.5	35	1.8	45	R05 Lot No.	10.5
SS11VL-R06270	0.6	27	1.3	45	R06 Lot No.	11.1
SS11VL-R07190	0.7	19	0.90	45	R07 Lot No.	10.8
SS11VL-R08125	0.8	12.5	0.74	45	R08 Lot No.	9.8
SS11VL-R10093	1.0	9.3	0.44	45	R10 Lot No.	11.1
SS11VL-R11076	1.1	7.6	0.40	45	R11 Lot No.	10.7
SS11VL-R13052	1.3	5.2	0.28	45	R13 Lot No.	10.5
SS11VL-R17036	1.7	3.6	0.19	45	R17 Lot No.	10.8
SS11VL-R22020	2.2	2.0	0.12	45	R22 Lot No.	10.4
SS11VL-R30009	3.0	0.9	0.06	45	R30 Lot No.	9.6

## Specifications

Item	SS11VL
Rated Voltage	250 VAC
Withstanding Voltage	2400 VAC (2 seconds, between lines)
Insulation Resistance	> 100 MΩ @ 500 VDC (between lines)
Thermal Class	E (120°C)
Operating Temperature Range	-25°C to T (T = 120 - temperature rise)
Inductance Measurement Condition	1 kHz, 1 V, KC530

## Frequency Characteristics

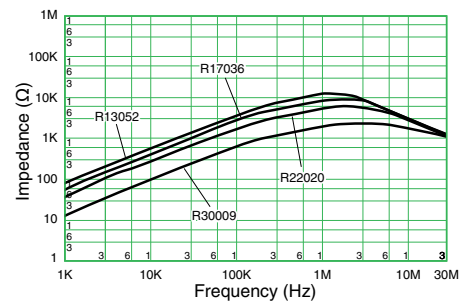
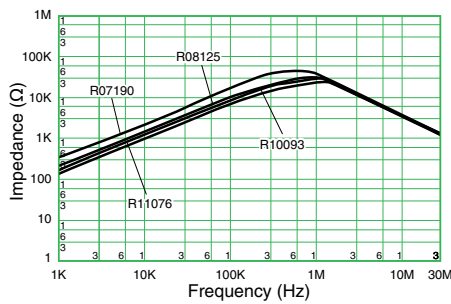
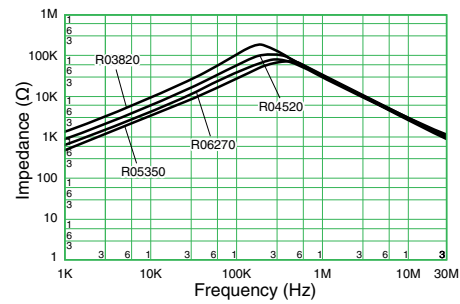
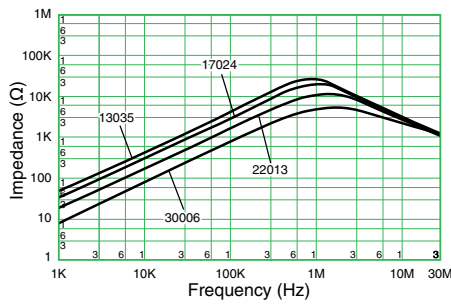
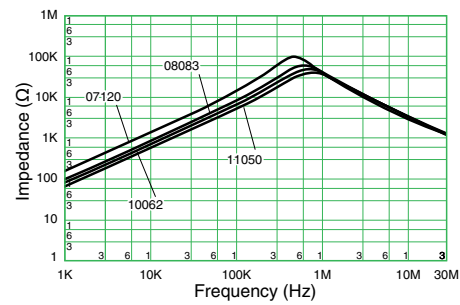
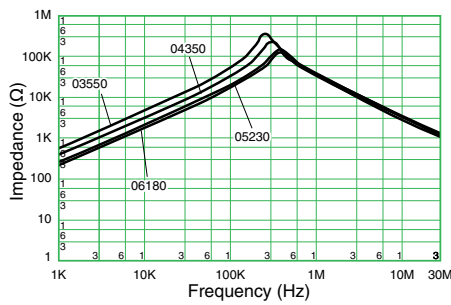

## Notes on Use

### Shelf Life

- Use within 6 months. If the product is used after a storage period of 6 months or longer, confirm its solderability before use.

### Storage Condition

- Avoid storage in high temperature and high humidity environment, as such condition may deteriorate the solderability of external electrode.
- Avoid storage in atmosphere containing toxic gases or acid (e.g., sulphur and chlorine), as such gas may deteriorate the solderability of external electrode.
- Avoid storage near strong magnetic field, as such condition may magnetize the product.

## KEMET Corporation World Headquarters

2835 KEMET Way  
Simpsonville, SC 29681

Mailing Address:  
P.O. Box 5928  
Greenville, SC 29606

www.kemet.com  
Tel: 864-963-6300  
Fax: 864-963-6521

**Corporate Offices**  
Fort Lauderdale, FL  
Tel: 954-766-2800

## North America

**Northeast**  
Wilmington, MA  
Tel: 978-658-1663

**Southeast**  
Lake Mary, FL  
Tel: 407-855-8886

**Central**  
Novi, MI  
Tel: 248-994-1030

Irving, TX  
Tel: 972-915-6041

**West**  
Milpitas, CA  
Tel: 408-433-9950

**Mexico**  
Guadalajara, Jalisco  
Tel: 52-33-3123-2141

## Europe

**Southern Europe**  
Sasso Marconi, Italy  
Tel: 39-051-939111

Skopje, Macedonia  
Tel: 389-2-55-14-623

**Central Europe**  
Landsberg, Germany  
Tel: 49-8191-3350800

Kamen, Germany  
Tel: 49-2307-438110

**Northern Europe**  
Wyboston, United Kingdom  
Tel: 44-1480-273082

Espoo, Finland  
Tel: 358-9-5406-5000

## Asia

**Northeast Asia**  
Hong Kong  
Tel: 852-2305-1168

Shenzhen, China  
Tel: 86-755-2518-1306

Beijing, China  
Tel: 86-10-5877-1075

Shanghai, China  
Tel: 86-21-6447-0707

Seoul, South Korea  
Tel: 82-2-6294-0550

Taipei, Taiwan  
Tel: 886-2-27528585

**Southeast Asia**  
Singapore  
Tel: 65-6701-8033

Penang, Malaysia  
Tel: 60-4-6430200

Bangalore, India  
Tel: 91-806-53-76817

*Note: KEMET reserves the right to modify minor details of internal and external construction at any time in the interest of product improvement. KEMET does not assume any responsibility for infringement that might result from the use of KEMET Capacitors in potential circuit designs. KEMET is a registered trademark of KEMET Electronics Corporation.*

## Disclaimer

This product has been made available through a Private Label Agreement and a Development and Cross-Licensing Agreement between KEMET and NEC TOKIN to expand market and product offerings for both companies and their respective customers. For more information, please visit <http://www.kemet.com/nectokin>.

All product specifications, statements, information and data (collectively, the "Information") in this datasheet are subject to change. The customer is responsible for checking and verifying the extent to which the Information contained in this publication is applicable to an order at the time the order is placed.

All Information given herein is believed to be accurate and reliable, but it is presented without guarantee, warranty, or responsibility of any kind, expressed or implied.

Statements of suitability for certain applications are based on KEMET Electronics Corporation's ("KEMET") knowledge of typical operating conditions for such applications, but are not intended to constitute – and KEMET specifically disclaims – any warranty concerning suitability for a specific customer application or use. The Information is intended for use only by customers who have the requisite experience and capability to determine the correct products for their application. Any technical advice inferred from this Information or otherwise provided by KEMET with reference to the use of KEMET's products is given gratis, and KEMET assumes no obligation or liability for the advice given or results obtained.

Although KEMET designs and manufactures its products to the most stringent quality and safety standards, given the current state of the art, isolated component failures may still occur. Accordingly, customer applications which require a high degree of reliability or safety should employ suitable designs or other safeguards (such as installation of protective circuitry or redundancies) in order to ensure that the failure of an electrical component does not result in a risk of personal injury or property damage.

Although all product-related warnings, cautions and notes must be observed, the customer should not assume that all safety measures are indicated or that other measures may not be required.