

Transient Voltage Suppressors for ESD Protection

General Description

The LESD5Z2.5T1G Series is designed to protect voltage sensitive components from ESD and transient voltage events. Excellent clamping capability, low leakage, and fast response time, make these parts ideal for ESD protection on designs where board space is at a premium.

Applications

- Cellular phones
- Portable devices
- Digital cameras
- Power supplies

Features

- Small Body Outline Dimensions
- Low Body Height
- Stand-off Voltage: 2.5 V – 15 V
- Peak Power up to 200 Watts @ 8 x 20 μ s Pulse
- Low Leakage
- Response Time is Typically < 1 ns
- ESD Rating of Class 3 (> 16 kV) per Human Body Model
- IEC61000-4-2 Level 4 ESD Protection
- IEC61000-4-4 Level 4 EFT Protection
- We declare that the material of product compliance with RoHS requirements.
- S- Prefix for Automotive and Other Applications Requiring Unique Site and Control Change Requirements; AEC-Q101 Qualified and PPAP Capable.

**LESD5Z2.5T1G SERIES
S-LESD5Z2.5T1G SERIES**

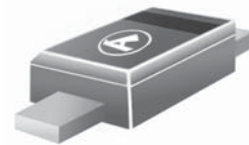

SOD-523

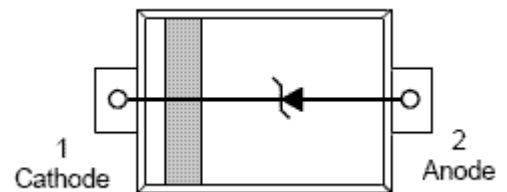

ORDERING INFORMATION

Device	Package	Shipping
LESD5Z2.5T1G SERIES S-LESD5Z2.5T1G SERIES	SOD-523	3000/Tape & Reel

Absolute Ratings (T_{amb}=25°C)

Symbol	Parameter	Value	Units	
P _{PP}	Peak Pulse Power (t _p = 8/20 μ s)	200	W	
T _L	Maximum lead temperature for soldering during 10s	260	°C	
T _{stg}	Storage Temperature Range	-55 to +150	°C	
T _{op}	Operating Temperature Range	-40 to +125	°C	
T _j	Maximum junction temperature	150	°C	
	IEC61000-4-2 (ESD)	air discharge ± 15 contact discharge ± 8	KV	
	IEC61000-4-4 (EFT)	40	A	
	ESD Voltage	Per Human Body Model	16	KV

LESD5Z2.5T1G SERIES , S-LESD5Z2.5T1G SERIES

Electrical Parameter

Symbol	Parameter
I_{PP}	Maximum Reverse Peak Pulse Current
V_C	Clamping Voltage @ I_{PP}
V_{RWM}	Working Peak Reverse Voltage
I_R	Maximum Reverse Leakage Current @ V_{RWM}
I_T	Test Current
V_{BR}	Breakdown Voltage @ I_T
I_F	Forward Current
V_F	Forward Voltage @ I_F

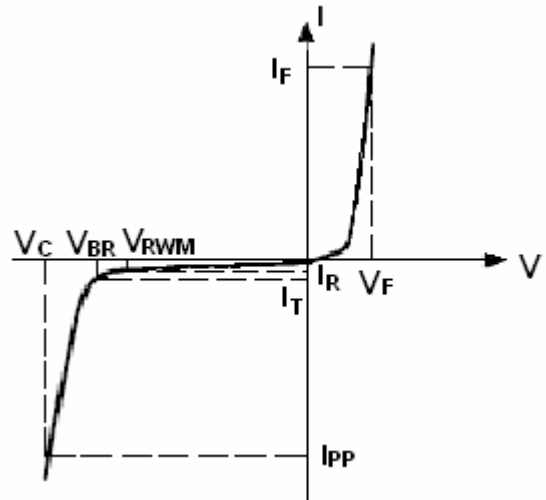

Electrical Characteristics

Ratings at 25°C ambient temperature unless otherwise specified. $V_F = 0.9V$ at $I_F = 10mA$

Device	Device Marking	V_{RWM} (V)	$I_R(\mu A)$ @ V_{RWM}	V_{BR} (V) @ I_T (Note 1)	I_T	V_C (V) @ $I_{PP}=5 A^*$	V_C (V) @ Max I_{PP}^*	I_{PP} (A)*	P_{PK} (W)*	C (pF)
		Max	Max	Min	mA	Typ	Max	Max	Max	Typ
LESD5Z2.5T1G	ZD	2.5	6.0	4.0	1.0	6.5	10.9	11.0	120	145
LESD5Z3.3T1G	ZE	3.3	1.0	5.0	1.0	8.4	14.1	11.2	158	105
LESD5Z5.0T1G	ZF	5.0	1.0	6.2	1.0	11.6	18.6	9.4	174	80
LESD5Z6.0T1G	ZG	6.0	1.0	6.8	1.0	12.4	20.5	8.8	181	70
LESD5Z7.0T1G	ZH	7.0	1.0	7.5	1.0	13.5	22.7	8.8	200	65
LESD5Z12T1G	ZM	12	1.0	13.5	1.0	17	25	9.6	240	55
LESD5Z15T1G	ZN	15	1.0	16.5	1.0	22	26	10	260	65

*Surge current waveform per Figure 1.

- V_{BR} is measured with a pulse test current I_T at an ambient temperature of 25°C.

LESD5Z2.5T1G SERIES , S-LESD5Z2.5T1G SERIES

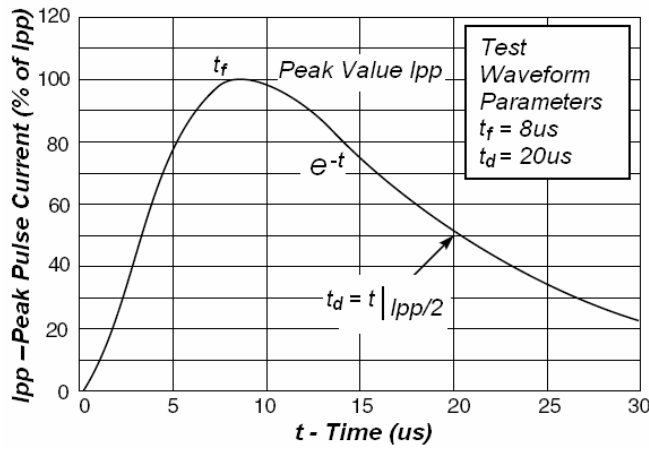

Fig1. Pulse Waveform

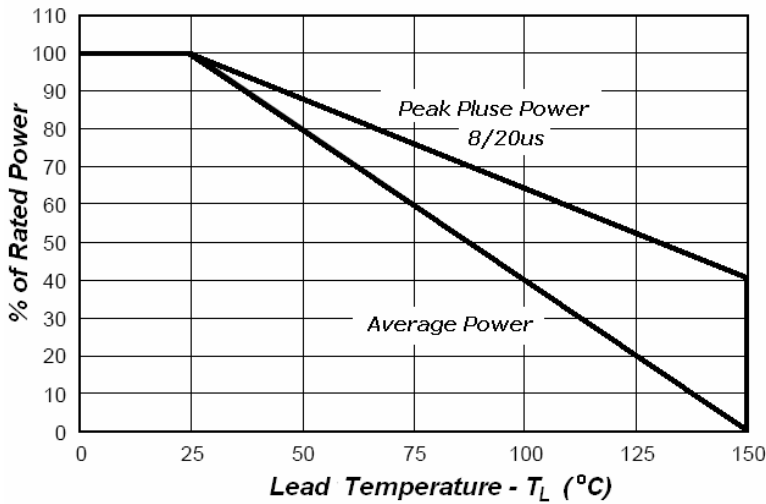

Fig3. Power Derating

Application Note

Electrostatic discharge (ESD) is a major cause of failure in electronic systems. Transient Voltage Suppressors (TVS) are an ideal choice for ESD protection. They are capable of clamping the incoming transient to a low enough level such that damage to the protected semiconductor is prevented.

Surface mount TVS offer the best choice for minimal lead inductance. They serve as parallel protection elements, connected between the signal line to ground. As the transient rises above the operating voltage of the device, the TVS becomes a low impedance path diverting the transient current to ground. The LESD5Z2.5T1G is the ideal board level protection of ESD sensitive semiconductor components.

The tiny SOD523 package allows design flexibility in the design of high density boards where the space saving is at a premium. This enables to shorten the routing and contributes to hardening against ESD.

LESD5Z2.5T1G SERIES , S-LESD5Z2.5T1G SERIES

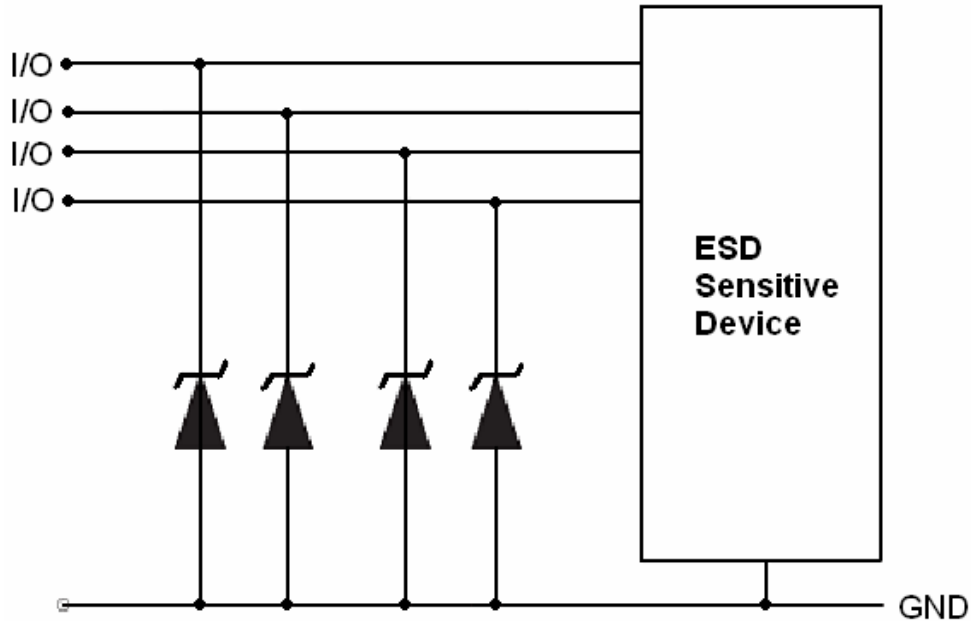

SC-79/SOD-523

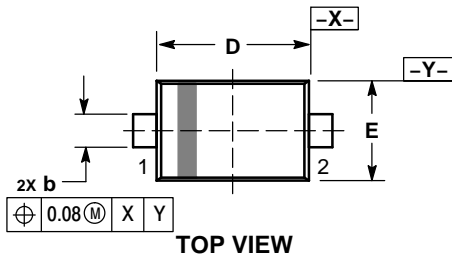

TOP VIEW

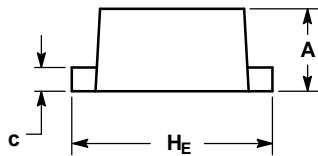

SIDE VIEW

**RECOMMENDED
SOLDERING FOOTPRINT***

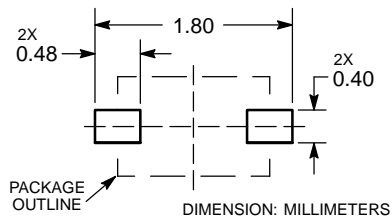

NOTES:

1. DIMENSIONING AND TOLERANCING PER ASME Y14.5M, 1994.
2. CONTROLLING DIMENSION: MILLIMETERS.
3. MAXIMUM LEAD THICKNESS INCLUDES LEAD FINISH. MINIMUM LEAD THICKNESS IS THE MINIMUM THICKNESS OF BASE MATERIAL.
4. DIMENSIONS D AND E DO NOT INCLUDE MOLD FLASH, PROTRUSIONS, OR GATE BURRS.

DIM	MILLIMETERS		
	MIN	NOM	MAX
A	0.50	0.60	0.70
b	0.25	0.30	0.35
c	0.07	0.14	0.20
D	1.10	1.20	1.30
E	0.70	0.80	0.90
HE	1.50	1.60	1.70
L	0.30 REF		
L2	0.15	0.20	0.25

EMBOSSED TAPE AND REEL DATA FOR DISCRETES CARRIER TAPE SPECIFICATIONS

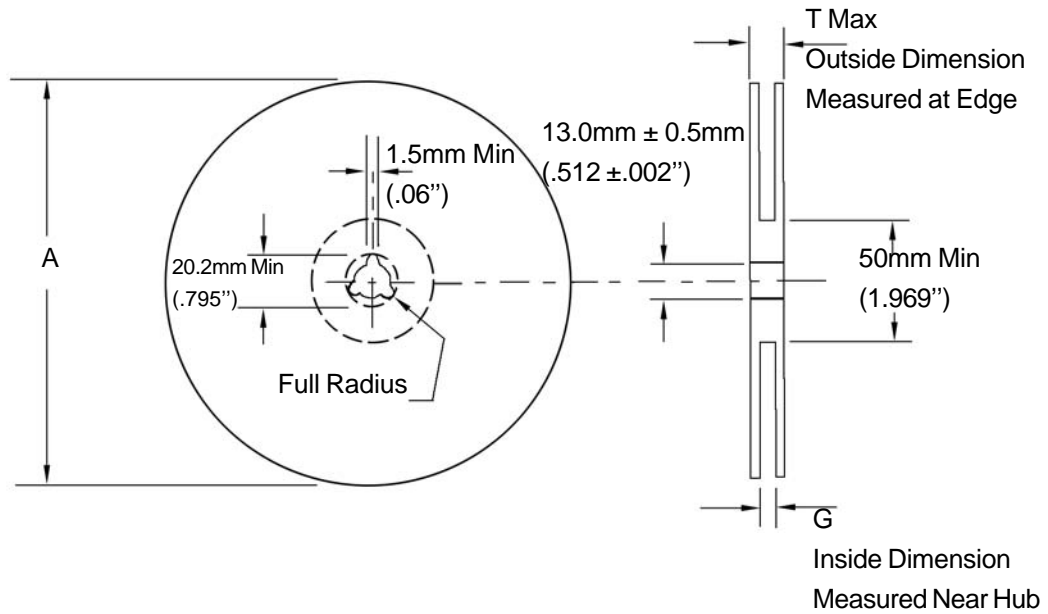

Size	A Max	G	T Max
8 mm	178.0mm (7.0")	8.4mm+1.5mm, -0.0 (.33"+.039", -0.00)	10.9mm (.43")

Reel Dimensions

Metric Dimensions Govern — English are in parentheses for reference only

Storage Conditions

Temperature: 5 to 40 Deg.C (20 to 30 Deg. C is preferred)

Humidity: 30 to 80 RH (40 to 60 is preferred)

Recommended Period: One year after manufacturing

(This recommended period is for the soldering condition only. The characteristics and reliabilities of the products are not restricted to this limitation)

Shipment Specification

