

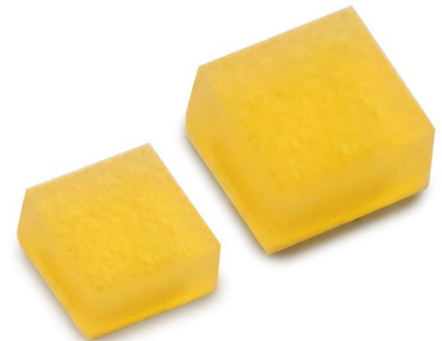

LUXEON FlipChip White

Chip-scale packages for maximum design flexibility

LUXEON FlipChip White enables the next generation of lighting applications. Lumileds industry-leading line of Chip Scale Package (CSP) LEDs gives customers complete design flexibility. LUXEON FlipChip White includes the highest flux-density chip scale package, maximizing beam control and enabling high packing density on a PCB. Its wide viewing angle delivers increased uniformity and potential for system cost reductions in diffuse and omnidirectional lighting applications. In addition, LUXEON FlipChip White is the ideal choice for cost sensitive applications as it can achieve high efficacy and flux at high current density, providing leading lm/\$.



FEATURES AND BENEFITS

- Direct attach — no wire bonds for high reliability
- Micro sized: 1.4mm x 1.4mm and 1.1mm x 1.1mm packages for design flexibility and high packing density
- Small source size for highest luminance and beam control
- Wide viewing angle provides increased uniformity
- High efficacy at high drive current provides leading system level lm/\$
- Low thermal resistance down to 2°C/W for LUXEON FlipChip White 10

PRIMARY APPLICATIONS

- Downlights
- High Bay & Low Bay
- Lamps
- Outdoor
- Specialty Lighting
- Spotlights

Table of Contents

General Product Information	2
Product Test Conditions	2
Part Number Nomenclature	2
Lumen Maintenance	2
Environmental Compliance	2
Performance Characteristics	3
Product Selection Guide	3
Optical Characteristics	3
Electrical and Thermal Characteristics	3
Absolute Maximum Ratings	4
Characteristic Curves	5
Spectral Power Distribution Characteristics	5
Light Output Characteristics	6
Forward Current Characteristics	7
Radiation Pattern Characteristics	8
Product Bin and Labeling Definitions	10
Decoding Product Bin Labeling	10
Luminous Flux Bins	11
Color Bin Definition	12
Forward Voltage Bins	13
Mechanical Dimensions	13
Reflow Soldering Guidelines	15
JEDEC Moisture Sensitivity	15
Solder Pad Design	16
Packaging Information	17
Bin Sheet	17
Tape and Reel Dimensions	18

General Product Information

Product Test Conditions

LUXEON FlipChip White LEDs are tested and binned with a DC drive current of 175mA for LUXEON FlipChip White 05 and 350mA for LUXEON FlipChip White 10 at a junction temperature, T_j , of 85°C. LUXEON FlipChip White is specified based on measurements on a ceramic tile with high reflective surface.

Part Number Nomenclature

Part numbers for LUXEON FlipChip White follow the convention below:

L **A** F 2 – **B B C C D D** 0 0 0 0 0 0 0

Where:

- A** – designates packaging option (0=bin sheet, 1=tape and reel)
- B B** – designates nominal CCT (27=2700K, 30=3000K, 40=4000K)
- C C** – designates minimum CRI performance (70=70CRI, 80=80CRI)
- D D** – designates product (05=LUXEON FlipChip White 05, 10=LUXEON FlipChip White 10)

Therefore, the following part number is used for a LUXEON FlipChip 10 3000K 80CRI, packaged in a tape and reel:

L **1** F 2 – **3 0 8 0 1 0** 0 0 0 0 0 0 0

Lumen Maintenance

Please contact your local Sales Representative or Lumileds Technical Solutions Manager for more information about the long-term performance of this product.

Environmental Compliance

Lumileds LLC is committed to providing environmentally friendly products to the solid-state lighting market. LUXEON FlipChip White is compliant to the European Union directives on the restriction of hazardous substances in electronic equipment, namely the RoHS Directive 2011/65/EU and REACH Regulation (EC) 1907/2006. Lumileds LLC will not intentionally add the following restricted materials to its products: lead, mercury, cadmium, hexavalent chromium, polybrominated biphenyls (PBB) or polybrominated diphenyl ethers (PBDE).

Performance Characteristics

Product Selection Guide

Table 1. Product performance of LUXEON FlipChip White at test current, $T_j=85^\circ\text{C}$.

PRODUCT	NOMINAL CCT	MINIMUM CRI ^[1, 2]	LUMINOUS FLUX ^[1] (lm)		TYPICAL LUMINOUS EFFICACY (lm/W)	TYPICAL LUMINOUS FLUX (lm)	TYPICAL LUMINOUS EFFICACY (lm/W)	TEST CURRENT (mA)	PART NUMBER
			MINIMUM	TYPICAL					
			TEST CURRENT						
LUXEON FlipChip White 05	4000K	70	57	60	124	106	105	175	LxF2-4070050000000
	2700K	80	45	49	101	86	86	175	LxF2-2780050000000
	3000K	80	47	53	109	94	94	175	LxF2-3080050000000
LUXEON FlipChip White 10	4000K	70	120	135	139	238	118	350	LxF2-4070100000000
	5000K	70	120	137	141	242	120	350	LxF2-5070100000000
	5700K	70	120	137	141	242	120	350	LxF2-5770100000000
	2700K	80	90	108	111	189	94	350	LxF2-2780100000000
	3000K	80	100	114	118	200	99	350	LxF2-3080100000000
4000K	80	104	121	124	212	106	350	LxF2-4080100000000	

Notes for Table 1:

- Lumileds maintains a tolerance of ± 2 on CRI and $\pm 6.5\%$ on luminous flux measurements.
- Typical CRI is approximately 2 points higher than the minimum CRI specified, but this is not guaranteed.

Optical Characteristics

Table 2. Optical characteristics for LUXEON FlipChip White at test current, $T_j=85^\circ\text{C}$.

PART NUMBER	TYPICAL TOTAL INCLUDED ANGLE ^[1]	TYPICAL VIEWING ANGLE ^[2, 3]
LxF2-xxxxx0000000	168°	148°

Notes for Table 2:

- Total angle at which 90% of total luminous flux is captured.
- Viewing angle is the off axis angle from the LED centerline where the luminous intensity is $\frac{1}{2}$ of the peak value. Radiation pattern slice measured in the plane parallel to one of the four sides of the emitter.
- Represents optical characteristics when mounted on a silver reflective substrate.

Electrical and Thermal Characteristics

Table 3. Electrical and thermal characteristics for LUXEON FlipChip White at test current, $T_j=85^\circ\text{C}$.

PART NUMBER	FORWARD VOLTAGE (V) ^[1]			TYPICAL TEMPERATURE COEFFICIENT OF FORWARD VOLTAGE (mV/°C) ^[2]	TYPICAL THERMAL RESISTANCE — JUNCTION TO SOLDER PAD (°C/W)
	MINIMUM	TYPICAL	MAXIMUM		
LxF2-xxx050000000	2.50	2.77	3.10	-1.9	4
LxF2-xxx100000000	2.50	2.77	3.10	-1.9	2

Notes for Table 3:

- Lumileds maintains a tolerance of $\pm 0.06\text{V}$ on forward voltage measurements.
- Measured between 25°C and 85°C .

Absolute Maximum Ratings

Table 4. Absolute maximum ratings for LUXEON FlipChip White.

PARAMETER	MAXIMUM PERFORMANCE			
	LUXEON FLIPCHIP WHITE 05		LUXEON FLIPCHIP WHITE 10	
LED Junction Temperature ^[1] (DC & Pulse)	150°C	135°C	150°C	135°C
DC Forward Current ^[1,2]	350	525	700	1050
Peak Pulsed Forward Current ^[1,3]	420	600	840	1200
Storage Temperature	-40°C to 135°C			
Soldering Temperature	260°C			
Allowable Reflow Cycles ^[4]	3			
Reverse Voltage ($V_{reverse}$)	LUXEON LEDs are not designed to be driven in reverse bias			

Notes for Table 4:

1. Proper current derating must be observed to maintain the junction temperature below the maximum allowable junction temperature.
2. Residual periodic variations due to power conversion from alternating current (AC) to direct current (DC), also called "ripple," are acceptable if the following conditions are met:
 - The frequency of the ripple current is ≥ 100 Hz and amplitude $\leq 15\%$ of the maximum DC current are acceptable
 - The average current for each cycle does not exceed the maximum allowable DC forward current at the corresponding maximum junction temperature
 - The maximum amplitude of the ripple does not exceed the maximum peak pulsed forward current
3. Pulsed operation with a peak drive current equal to the stated Peak Pulsed Forward Current is acceptable if the pulse on-time is ≤ 5 ms per cycle and the duty cycle is $\leq 50\%$.
4. Per JEDEC J-STD-0202D MSL Classification.

Characteristic Curves

Spectral Power Distribution Characteristics

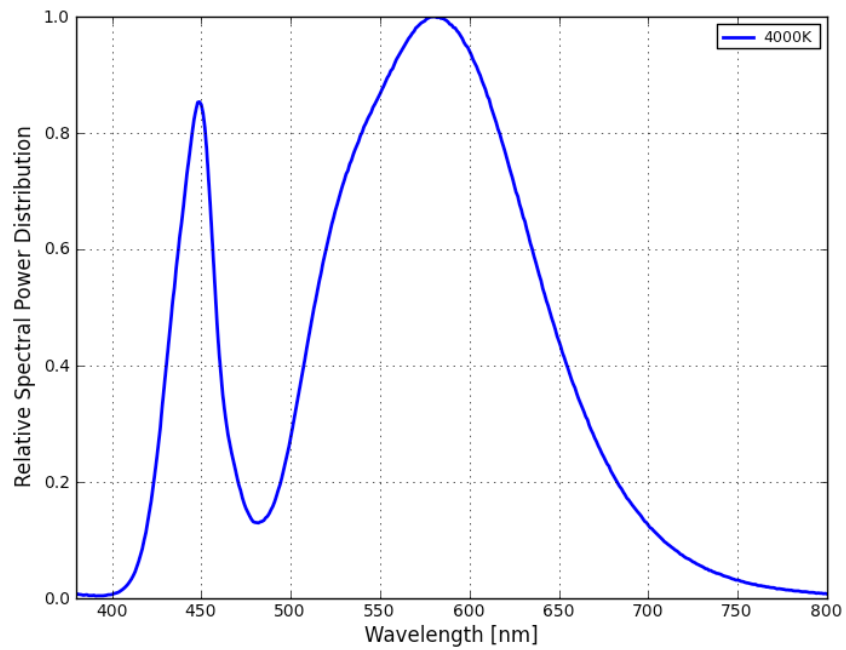

Figure 1a: Typical normalized power vs. wavelength for LxF2-xx70xx0000000 at specified test current, $T_j=85^{\circ}\text{C}$.

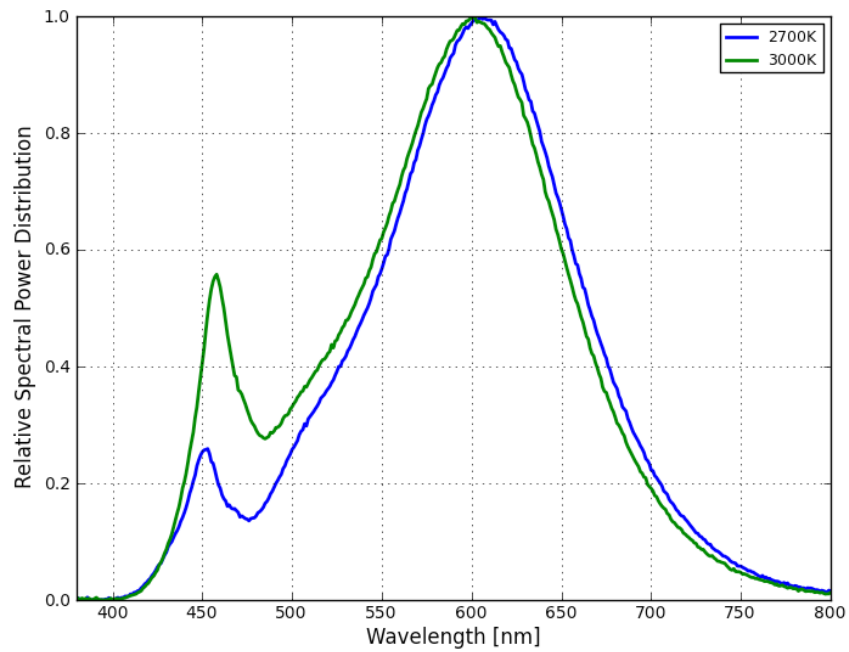

Figure 1b: Typical normalized power vs. wavelength for LxF2-xx80xx0000000 at specified test current.

Light Output Characteristics

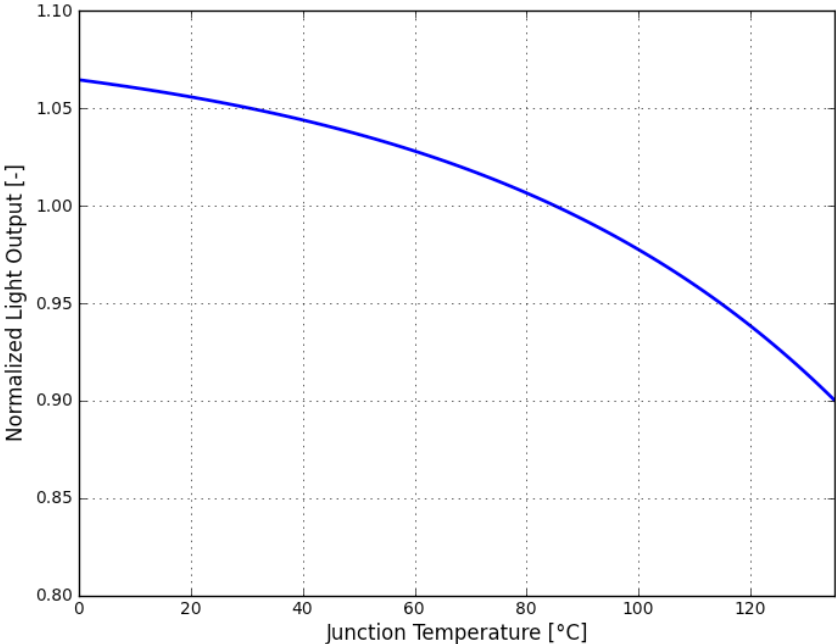

Figure 2a: Typical normalized light output vs. junction temperature for LUXEON FlipChip White at test current.

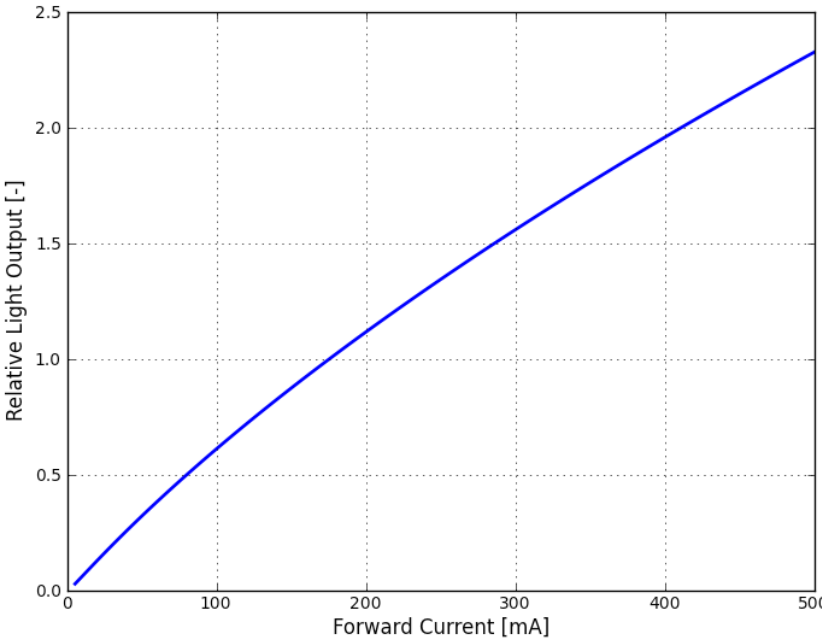

Figure 2b: Typical normalized light output vs. forward current for LUXEON FlipChip White 05, $T_j=85^\circ\text{C}$.

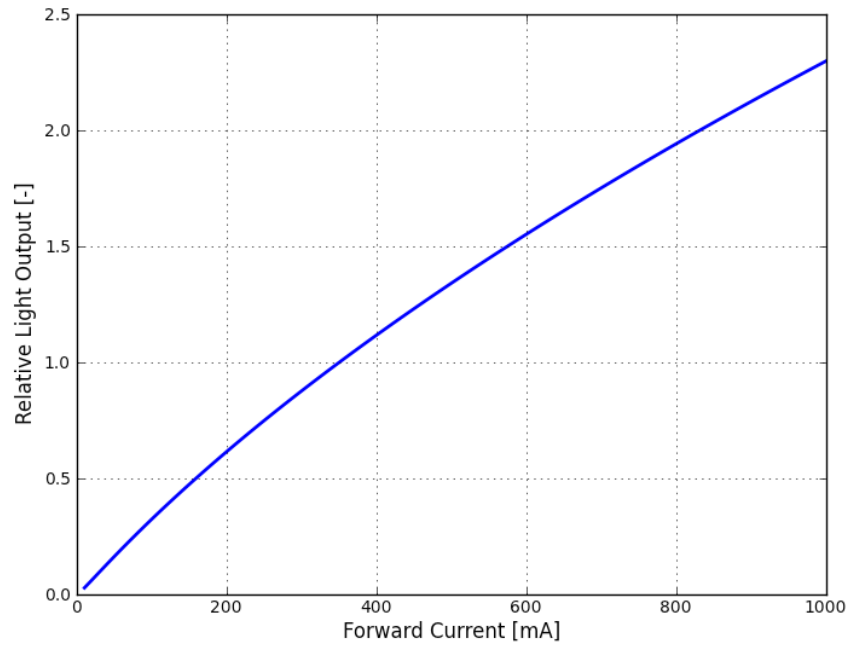

Figure 2c: Typical normalized light output vs. forward current for LUXEON FlipChip White 10, $T_j=85^\circ\text{C}$.

Forward Current Characteristics

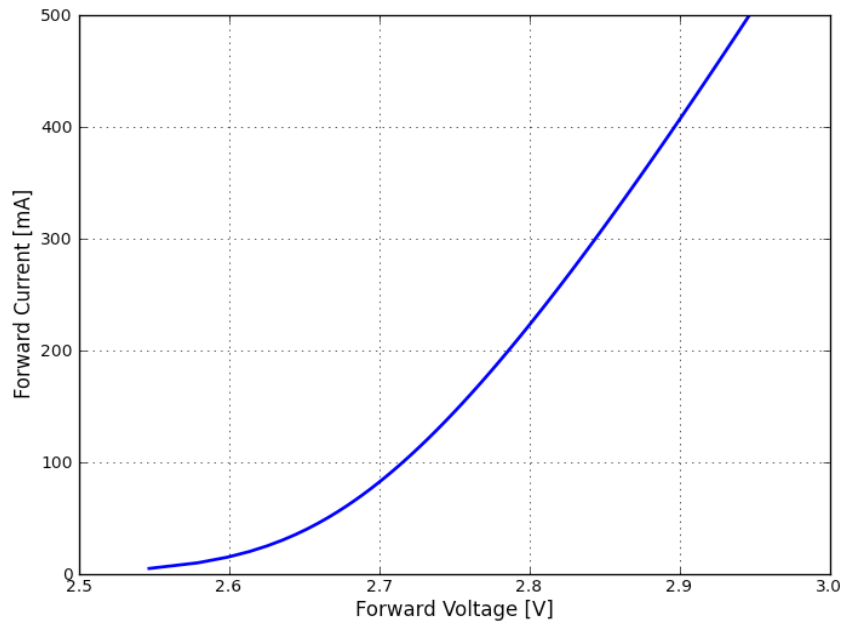

Figure 3a: Typical forward current vs. forward voltage for LUXEON FlipChip White 05, $T_j=85^\circ\text{C}$.

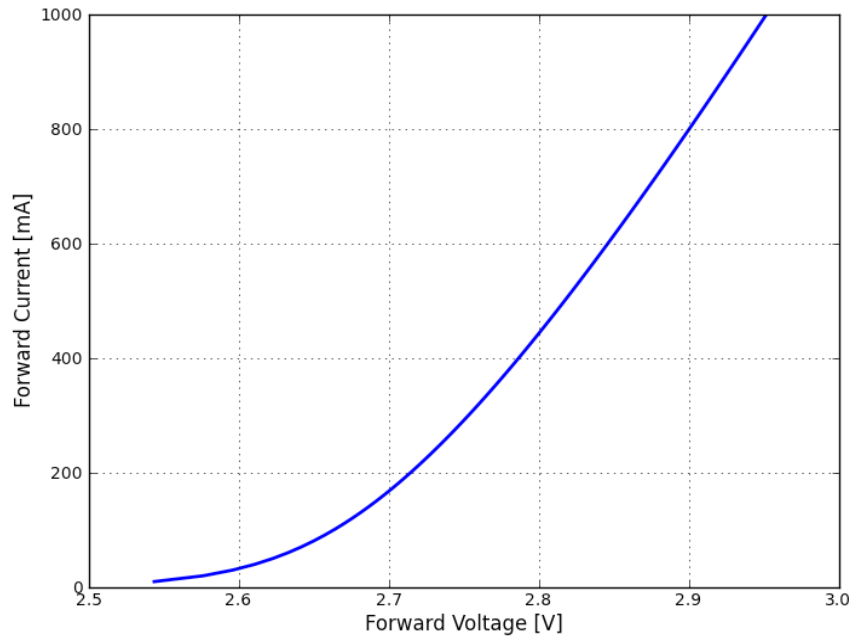

Figure 3b: Typical forward current vs. forward voltage for LUXEON FlipChip White 10, $T_j=85^\circ\text{C}$.

Radiation Pattern Characteristics

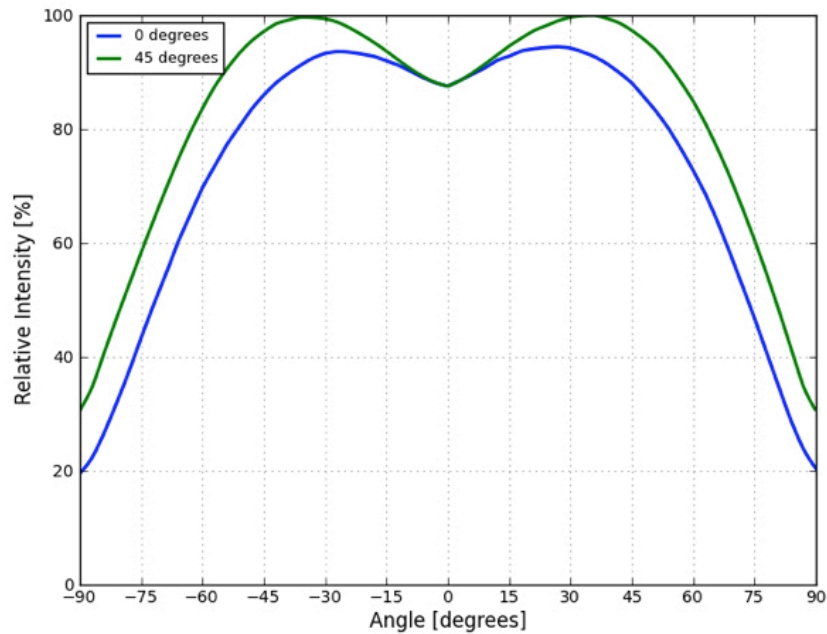

Figure 4a: Typical radiation pattern for LUXEON FlipChip White at specified test current, $T_j=85^\circ\text{C}$.

Notes for Figure 4a:

1. At 0° , the radiation pattern slice is measured in the plane parallel to one of the four sides of the emitter. The 45° radiation pattern is measured 45° off axis relative to the 0° radiation pattern slice.

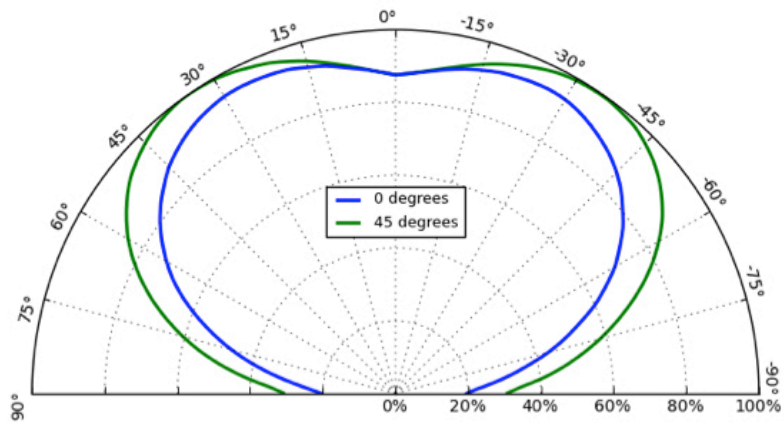

Figure 4b: Typical radiation pattern for LUXEON FlipChip White at specified test current, $T_j=85^{\circ}\text{C}$.

Notes for Figure 4b:

1. At 0° , the radiation pattern slice is measured in the plane parallel to one of the four sides of the emitter. The 45° radiation pattern is measured 45° off axis relative to the 0° radiation pattern slice.

Product Bin and Labeling Definitions

Decoding Product Bin Labeling

In the manufacturing of semiconductor products, there are variations in performance around the average values given in the technical datasheet. For this reason, Lumileds bins LED components for luminous flux or radiometric power, color point and forward voltage.

LUXEON FlipChip White LEDs are labeled using a 4-digit alphanumeric CAT code following the format below:

Where:

A B C D

- A** – designates luminous flux bin (example: B=55 to 60 lumens, C=60 to 65 lumens for LUXEON FlipChip White 05)
- B C** – designates color bin (example: 30, AA, AB, AC, AD, 5A, 5B, 5C or 5D for 70CRI parts)
- D** – designates forward voltage bin (example: Q=2.50 to 2.75V, R=2.75 to 3.00V)

Therefore, a LUXEON FlipChip White 05 with a lumen range of 55 to 60, color bin of 5C and a forward voltage range of 2.50 to 2.75V has the following CAT code:

B 5 C Q

Luminous Flux Bins

Table 5 lists the standard photometric luminous flux bins for LUXEON FlipChip White emitters. Although several bins are outlined, product availability in a particular bin varies by production run and by product performance. Not all bins are available in all CCTs.

Table 5. Luminous flux bin definitions for LUXEON FlipChip White.

PRODUCT	BIN	LUMINOUS FLUX (lm)	
		MINIMUM	MAXIMUM
LUXEON FlipChip White 05	8	40	45
	9	45	50
	A	50	55
	B	55	60
	C	60	65
	D	65	70
	E	70	75
LUXEON FlipChip White 10	F	75	80
	8	80	90
	9	90	100
	A	100	110
	B	110	120
	C	120	130
	D	130	140
E	140	150	
	F	150	160

Notes for Table 5:

1. Lumileds maintains a tolerance of $\pm 6.5\%$ on luminous flux measurements.

Color Bin Definition

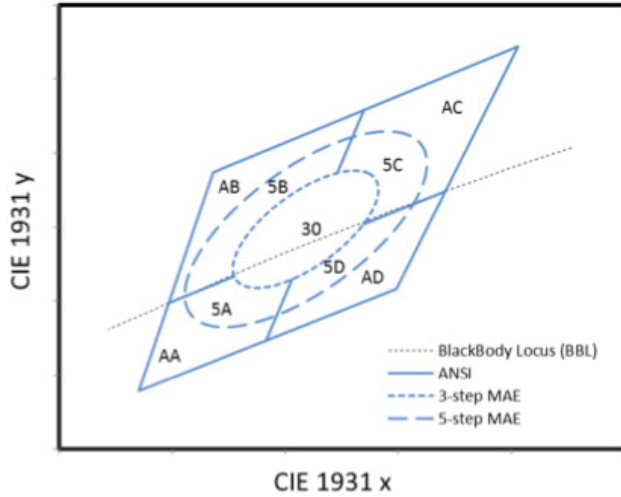

Figure 5: Color bin definition for LUXEON FlipChip White at 70 CRI.

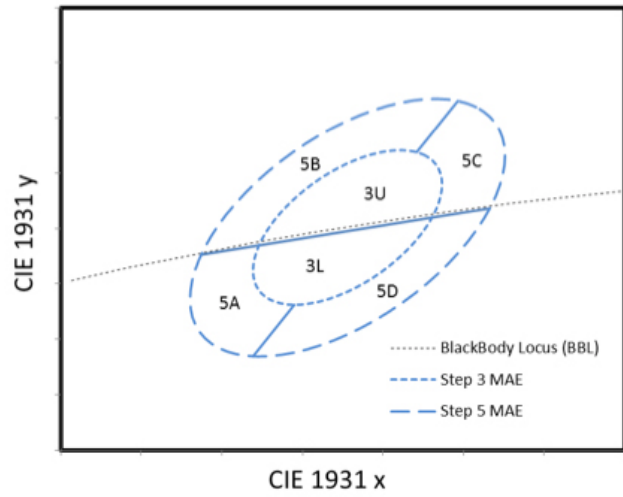

Figure 6: Color bin definition for LUXEON FlipChip White at 80 CRI.

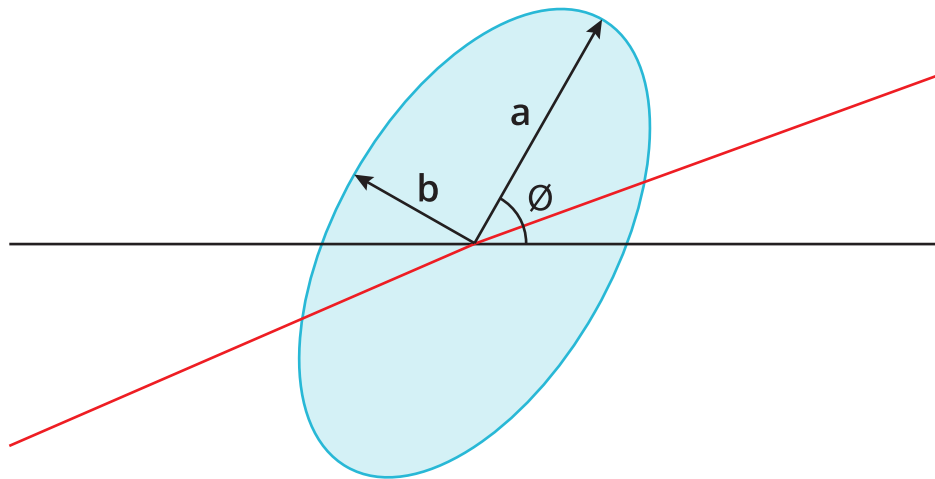

Figure 7: 3- and 5-step MacAdam ellipse illustration for Table 7.

Table 6. 3- and 5-step MacAdam ellipse color bin definitions for LUXEON FlipChip White.

NOMINAL CCT	COLOR SPACE ^[1, 2, 3]	CENTER POINT (cx, cy)	MAJOR AXIS, a	MINOR AXIS, b	ELLIPSE ROTATION ANGLE, θ
2700K	Single 3-step MacAdam ellipse	(0.4578, 0.4101)	0.00810	0.00420	53.7°
3000K	Single 3-step MacAdam ellipse	(0.4338, 0.4030)	0.00834	0.00408	53.2°
4000K	Single 3-step MacAdam ellipse	(0.3818, 0.3797)	0.00939	0.00402	53.7°
5000K	Single 3-step MacAdam ellipse	(0.3447, 0.3553)	0.00822	0.00354	59.6°
5700K	Single 3-step MacAdam ellipse	(0.3287, 0.3417)	0.00745	0.00319	59.1°
2700K	Single 5-step MacAdam ellipse	(0.4578, 0.4101)	0.01350	0.00700	53.7°
3000K	Single 5-step MacAdam ellipse	(0.4338, 0.4030)	0.01390	0.00680	53.2°
4000K	Single 5-step MacAdam ellipse	(0.3818, 0.3797)	0.01565	0.00670	53.7°
5000K	Single 5-step MacAdam ellipse	(0.3447, 0.3553)	0.01370	0.00590	59.6°
5700K	Single 5-step MacAdam ellipse	(0.3287, 0.3417)	0.01234	0.00533	59.1°

Notes for Table 6 :

1. The 3-step MacAdam ellipse is segmented into two sub-bins, one above (3U) and one below (3L) the blackbody line, for products with a minimum CRI of 80. Products with a minimum CRI of 70 are only available in a single 3-step MacAdam ellipse (30).
2. The 5-step MacAdam ellipse is divided into quadrants (5A, 5B, 5C, and 5D) for all products.
3. Lumileds maintains a tolerance of ±0.005 on x and y coordinates in the CIE 1931 color space.

Forward Voltage Bins

Table 7. Forward voltage bin definitions for LUXEON FlipChip White.

BIN	FORWARD VOLTAGE (V) ⁽¹⁾	
	MINIMUM	MAXIMUM
Q	2.50	2.75
R	2.75	3.00
S	3.00	3.25

Notes for Table 7:

1. Lumileds maintains a tolerance of $\pm 0.06V$ on forward voltage measurements.

Mechanical Dimensions

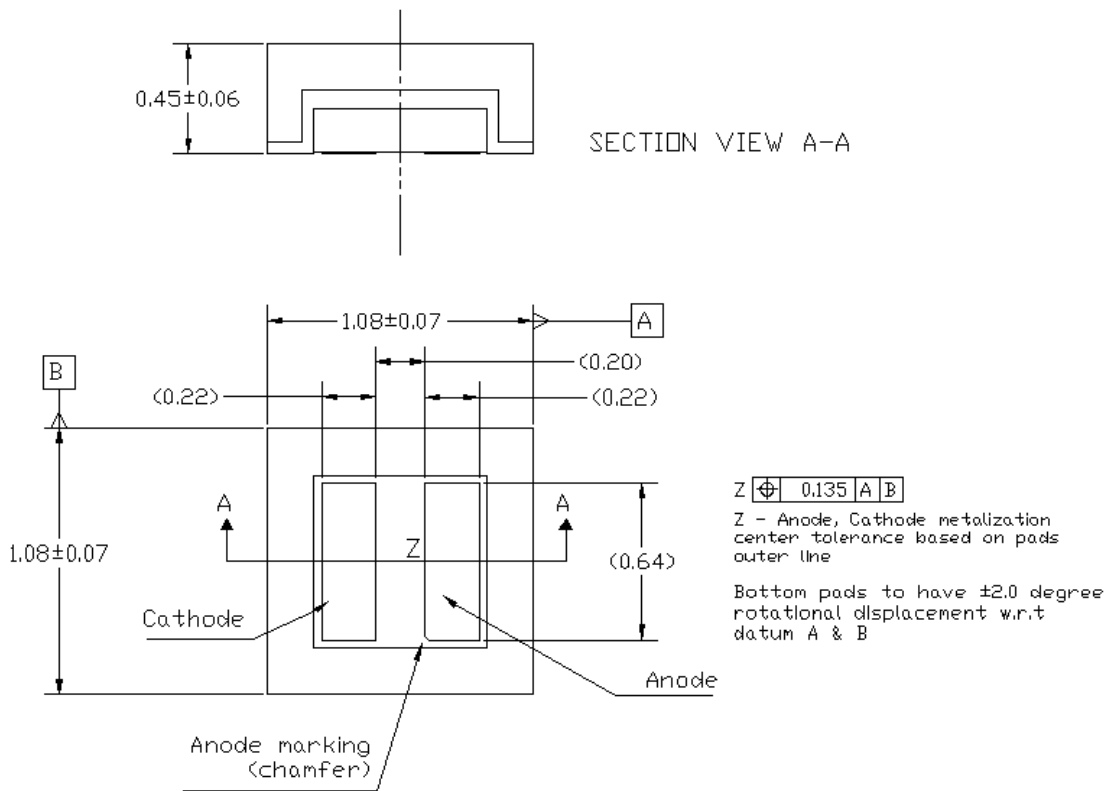

Figure 8: Mechanical dimensions for LUXEON FlipChip White 05.

Notes for Figure 8:

1. Drawings are not to scale.
2. All dimensions are in millimeters.

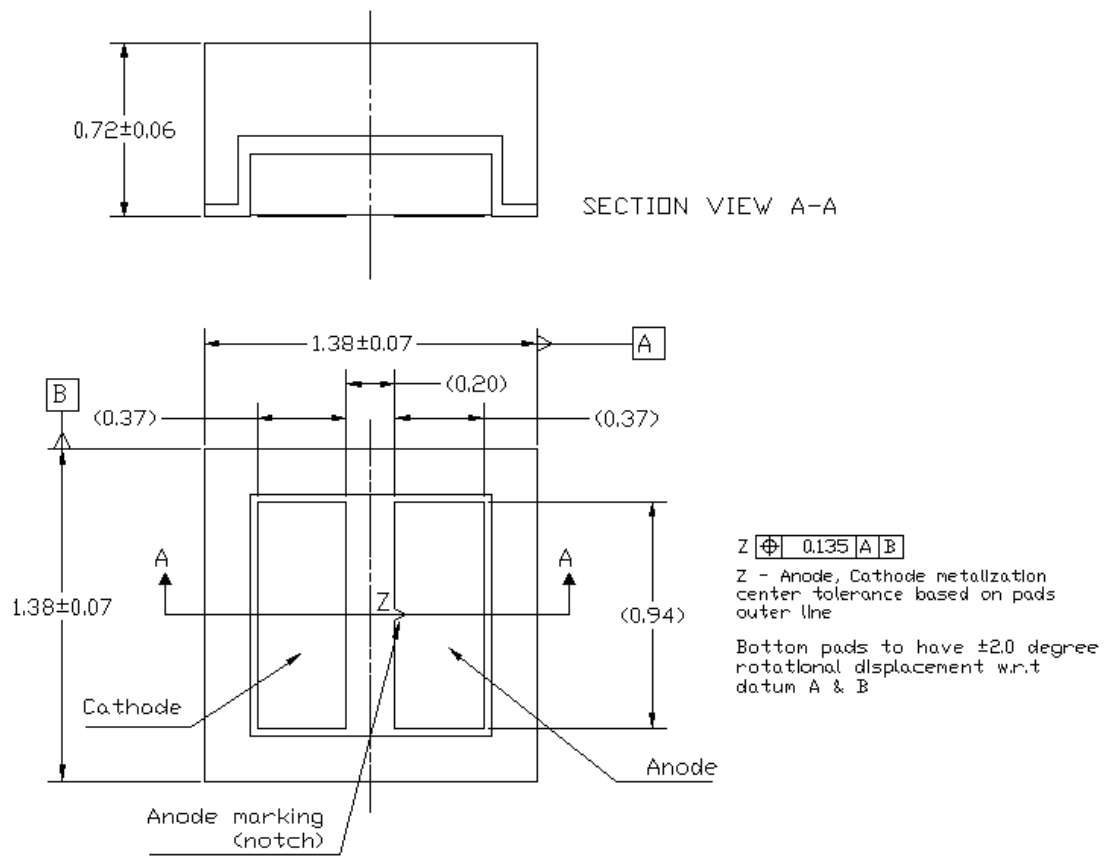

Figure 9: Mechanical dimensions for LUXEON FlipChip White 10.

Notes for Figure 9:

1. Drawings are not to scale.
2. All dimensions are in millimeters.

Reflow Soldering Guidelines

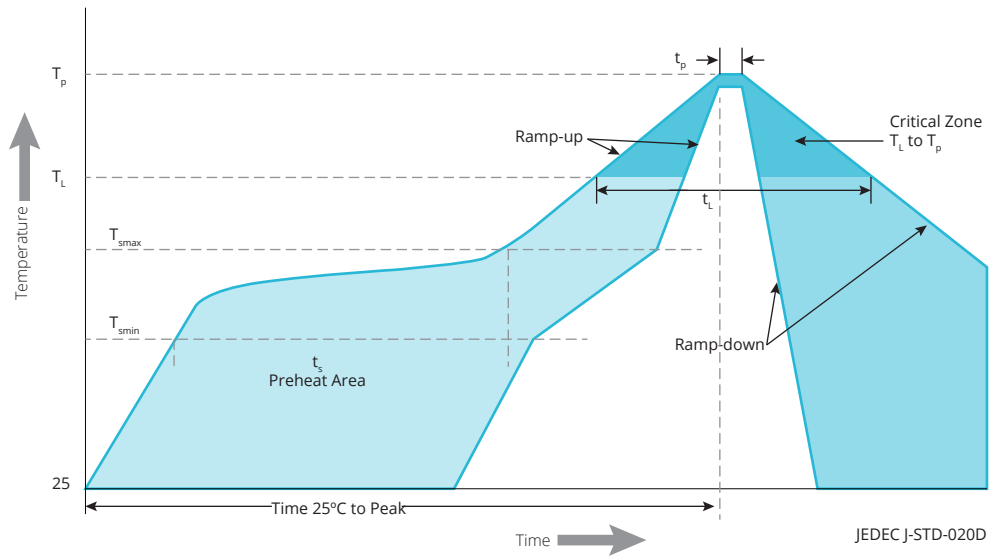

Figure 10: Visualization of the acceptable reflow temperature profile as specified in Table 10.

Table 8. Reflow profile characteristics for LUXEON FlipChip White.

PROFILE FEATURE	LEAD-FREE ASSEMBLY
Preheat Minimum Temperature (T_{smin})	150°C
Preheat Maximum Temperature (T_{smax})	200°C
Preheat Time (t_{smin} to t_{smax})	60 to 180 seconds
Ramp-Up Rate (T_{smax} to T_p)	3°C / second maximum
Liquidus Temperature (T_L)	217°C
Time Maintained Above Temperature T_L (t_t)	60 to 150 seconds
Peak / Classification Temperature (T_p)	260°C
Time Within 5°C of Actual Temperature (t_p)	20 to 40 seconds
Ramp-Down Rate	6°C / second maximum
Time 25°C to Peak Temperature	8 minutes maximum

JEDEC Moisture Sensitivity

Table 9. Moisture sensitivity levels for LUXEON FlipChip White.

LEVEL	FLOOR LIFE		SOAK REQUIREMENTS STANDARD	
	TIME	CONDITIONS	TIME	CONDITIONS
1	Unlimited	≤30°C / 85% RH	168 Hours +5 / -0	85°C / 85% RH

Solder Pad Design

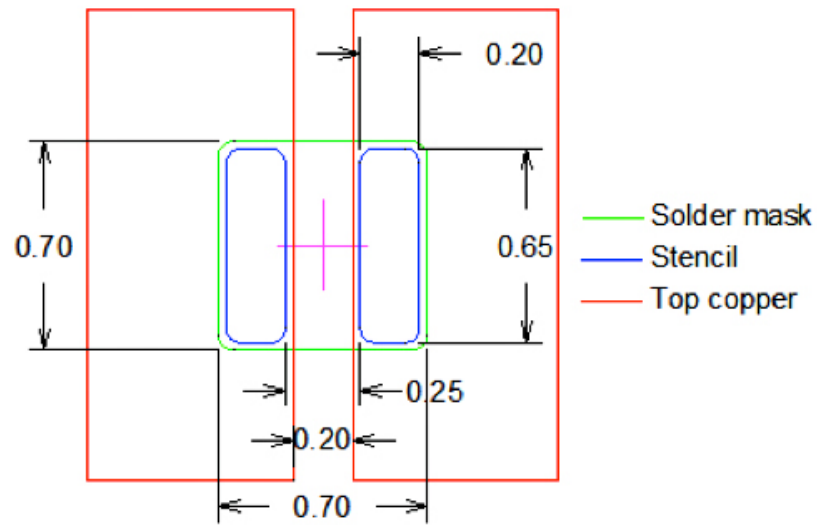

Figure 11: Recommended PCB solder pad layout for LUXEON FlipChip White 05.

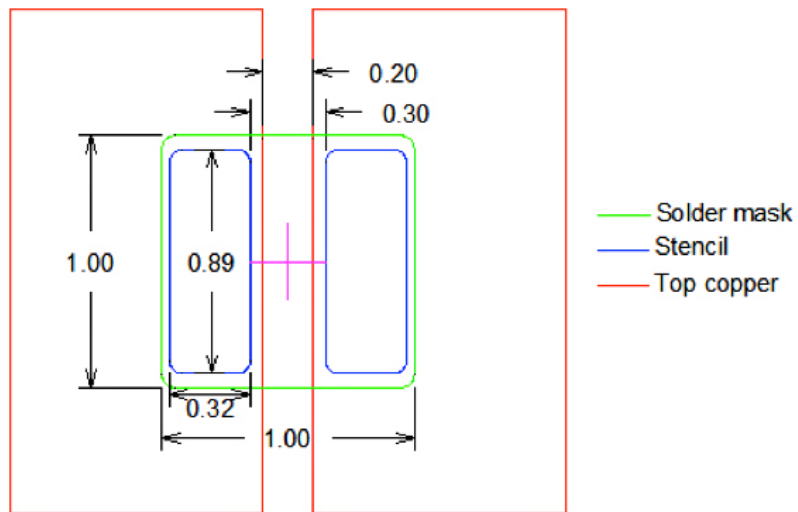

Figure 12: Recommended PCB solder pad layout for LUXEON FlipChip White 10.

Notes for Figures 11 and 12:
 1. Drawings are not to scale.
 2. All dimensions are in millimeters.

Packaging Information

Bin Sheet

Figure 13 shows the configuration and orientation of LUXEON FlipChip White packaged on bin sheet. The unit spacing is on average 0.70mm for LUXEON FlipChip White 05 and 0.40mm for LUXEON FlipChip White 10.

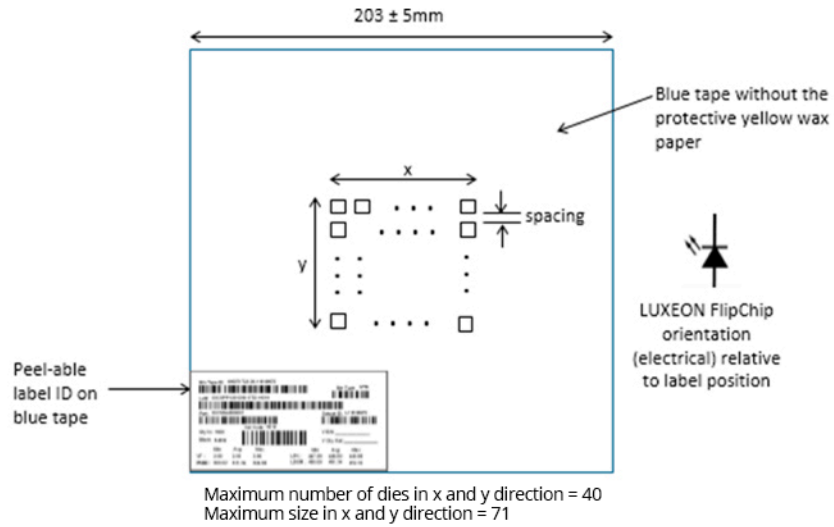

Figure 13: Example of bin sheet label for LUXEON FlipChip White.

Notes for Figure 13:

1. Drawings are not to scale.
2. All dimensions are in millimeters.

Tape and Reel Dimensions

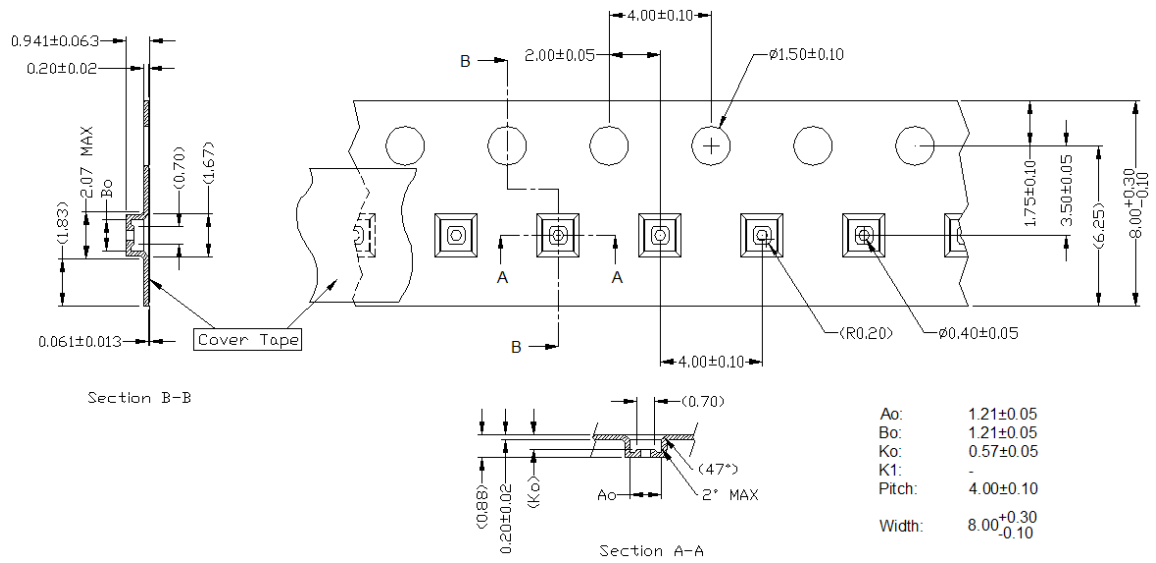

Figure 14: Tape dimensions for LUXEON FlipChip White 05.

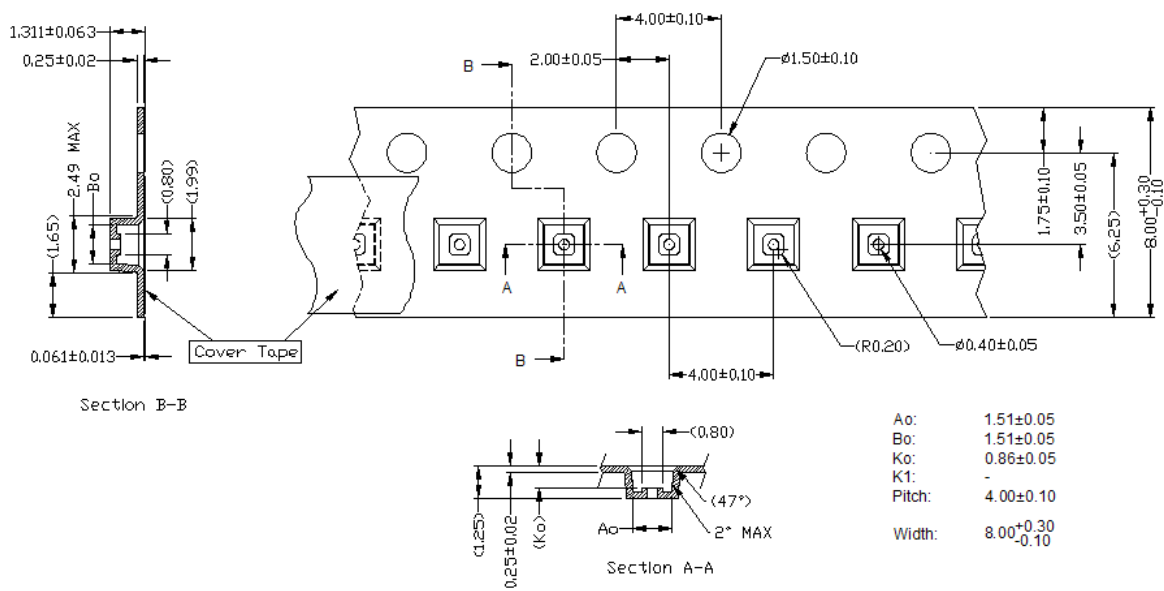

Figure 15: Tape dimensions for LUXEON FlipChip White 10.

- Notes for Figures 14 and 15:
1. Drawings are not to scale.
 2. All dimensions are in millimeters.

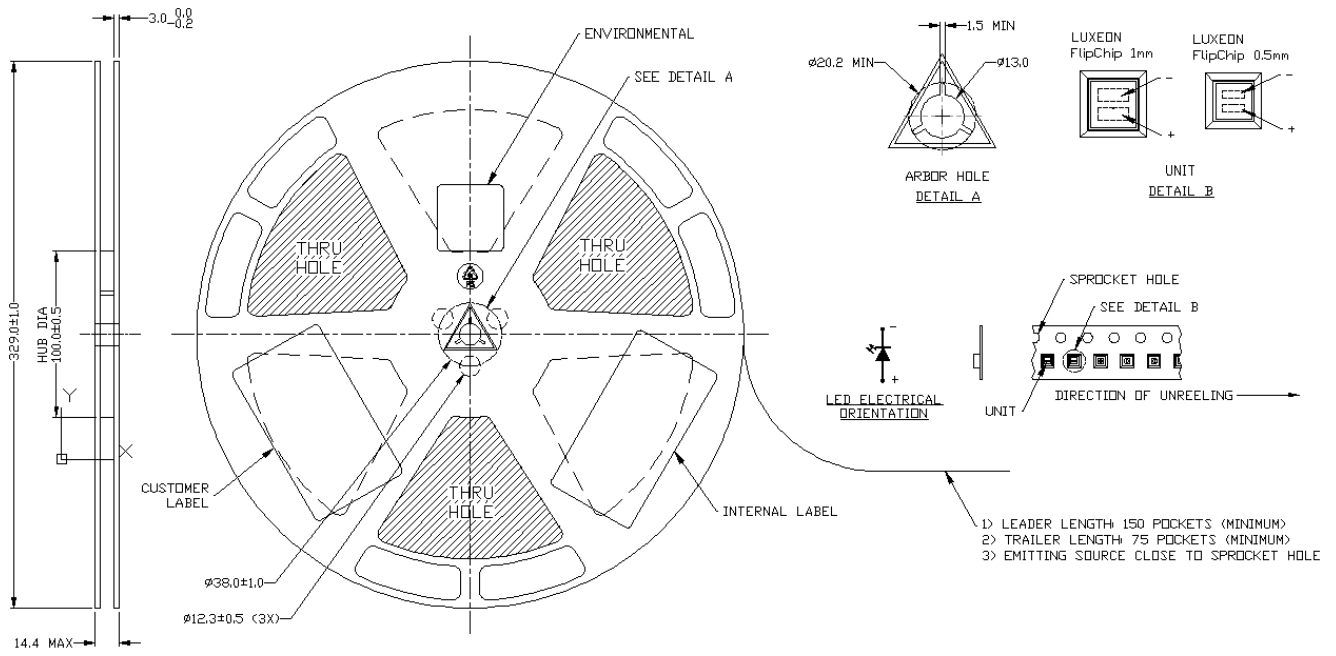

Figure 16: Reel dimensions for LUXEON FlipChip White.

Notes for Figure 16:

1. Drawings are not to scale.
2. All dimensions are in millimeters.

About Lumileds

Lumileds is the global leader in light engine technology. The company develops, manufactures and distributes groundbreaking LEDs and automotive lighting products that shatter the status quo and help customers gain and maintain a competitive edge. With a rich history of industry “firsts,” Lumileds is uniquely positioned to deliver lighting advancements well into the future by maintaining an unwavering focus on quality, innovation and reliability.

To learn more about our portfolio of light engines, visit lumileds.com.



©2015 Lumileds Holding B.V. All rights reserved.
LUXEON is a registered trademark of the Lumileds Holding B.V.
in the United States and other countries.
lumileds.com

Neither Lumileds Holding B.V. nor its affiliates shall be liable for any kind of loss of data or any other damages, direct, indirect or consequential, resulting from the use of the provided information and data. Although Lumileds Holding B.V. and/or its affiliates have attempted to provide the most accurate information and data, the materials and services information and data are provided “as is,” and neither Lumileds Holding B.V. nor its affiliates warrants or guarantees the contents and correctness of the provided information and data. Lumileds Holding B.V. and its affiliates reserve the right to make changes without notice. You as user agree to this disclaimer and user agreement with the download or use of the provided materials, information and data.