

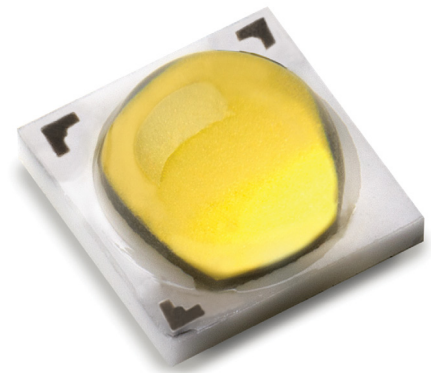

LUXEON TX

Extreme efficacy and best performance

LUXEON TX is designed to deliver high efficacy with high flux density to enable tight beam control in directional and high lumen applications. With *Freedom from Binning* and leading performance, LUXEON TX LEDs are specified, targeted and tested hot, at real world operating temperatures, 85°C, to ensure in-application performance. LUXEON TX LEDs allow system optimization by blending the perfect combination of high efficacy and low system cost, while tight correlated color temperature ensures consistency in system color point.



FEATURES AND BENEFITS

- Maximum drive current of 1.5A
- High lumen package and compact source size for design flexibility and reduced LED count
- Freedom from Binning* with 3- and 5-step MacAdam ellipse
- Exceeds ENERGY STAR® lumen maintenance requirements
- 70, 80 and 90CRI minimum and full CCT range available

PRIMARY APPLICATIONS

- Downlights
- High Bay & Low Bay
- Lamps
- Outdoor
- Spotlights

Table of Contents

General Product Information	2
Product Test Conditions	2
Part Number Nomenclature	2
Lumen Maintenance	2
Environmental Compliance	2
Performance Characteristics	3
Product Selection Guide	3
Optical Characteristics	3
Electrical and Thermal Characteristics	4
Absolute Maximum Ratings	4
Characteristic Curves	5
Spectral Power Distribution Characteristics	5
Light Output Characteristics	6
Forward Current Characteristics	7
Radiation Pattern Characteristics	8
Product Bin and Labeling Definitions	9
Decoding Product Bin Labeling	9
Luminous Flux Bins	9
Color Bin Definitions	10
Forward Voltage Bins	11
Mechanical Dimensions	11
Reflow Soldering Guidelines	12
JEDEC Moisture Sensitivity	12
Solder Pad Design	13
Packaging Information	14
Pocket Tape Dimensions	14
Reel Dimensions	15

General Product Information

Product Test Conditions

LUXEON TX LEDs are tested and binned with a DC drive current of 700mA at a junction temperature, T_j , of 85°C.

Part Number Nomenclature

Part numbers for LUXEON TX follow the convention below:

L 1 T 2 – **A A B B C 0 0 0 0 D D D 0**

Where:

- A A** - designates nominal ANSI CCT (27=2700K, 30=3000K, 35=3500, 40=4000, 50=5000, 57=5700, 65=6500)
- B B** - designates minimum CRI performance (70=70CRI, 80=80CRI, 85=85CRI, 90=90CRI)
- C** - designates color defintion (3=3 SDCM and 5=5 SDCM)
- D D D** - designates minimum luminous flux level at test conditions (210=210 lumens, etc.)

Therefore, the following part number is used for a LUXEON TX 3-step MacAdam ellipse, 3000K 80CRI with a minimum luminous flux of 210 lumens:

L 1 T 2 – **3 0 8 0 3 0 0 0 0 0 2 1 0 0**

Lumen Maintenance

Please contact your local Sales Representative or Lumileds Technical Solutions Manager for more information about the long-term performance of this product.

Environmental Compliance

Lumileds LLC is committed to providing environmentally friendly products to the solid-state lighting market. LUXEON TX is compliant to the European Union directives on the restriction of hazardous substances in electronic equipment, namely the RoHS Directive 2011/65/EU and REACH Regulation (EC) 1907/2006. Lumileds LLC will not intentionally add the following restricted materials to its products: lead, mercury, cadmium, hexavalent chromium, polybrominated biphenyls (PBB) or polybrominated diphenyl ethers (PBDE).

Performance Characteristics

Product Selection Guide

Table 1. Product performance of LUXEON TX at 700mA and 350mA, $T_j=85^\circ\text{C}$.

NOMINAL CCT	MINIMUM CRI ^[1, 2]	LUMINOUS FLUX ^[1] (lm)		TYPICAL LUMINOUS EFFICACY (lm/W)	TYPICAL LUMINOUS FLUX (lm)	TYPICAL LUMINOUS EFFICACY (lm/W)	PART NUMBER
		MINIMUM	TYPICAL				
		700mA					
3000K	70	230	245	125	135	142	L1T2-3070000000000
4000K	70	270	285	148	157	164	L1T2-4070000000000
5000K	70	270	285	148	157	164	L1T2-5070000000000
5700K	70	270	285	148	157	164	L1T2-5770000000000
6500K	70	270	285	148	157	164	L1T2-6570000000000
2700K	80	200	216	110	118	124	L1T2-2780000000000
3000K	80	210	227	116	124	131	L1T2-3080000000000
3500K	80	220	238	121	130	137	L1T2-3580000000000
4000K	80	230	247	126	136	143	L1T2-4080000000000
5000K	80	230	247	126	136	143	L1T2-5080000000000
2700K	85	170	186	95	102	108	L1T2-2785000000000
3000K	85	180	197	101	108	114	L1T2-3085000000000
3500K	85	190	208	106	114	120	L1T2-3585000000000
4000K	85	200	217	111	120	127	L1T2-4085000000000
5000K	85	200	217	111	120	127	L1T2-5085000000000
2700K	90	160	175	89	96	101	L1T2-2790000000000
3000K	90	170	188	96	103	109	L1T2-3090000000000
5700K	90	200	213	109	117	123	L1T2-5790000000000

Notes for Table 1:

1. Lumileds maintains a tolerance of ± 2 on CRI and $\pm 6.5\%$ on luminous flux measurements.
2. Typical CRI is approximately 2 points higher than the minimum CRI specified, but this is not guaranteed.

Optical Characteristics

Table 2. Optical characteristics for LUXEON TX at 700mA, $T_j=85^\circ\text{C}$.

PART NUMBER	TYPICAL TOTAL INCLUDED ANGLE ^[1]	TYPICAL VIEWING ANGLE ^[2]
L1T2-xxxx000000000	160°	120°

Notes for Table 2:

1. Total angle at which 90% of total luminous flux is captured.
2. Viewing angle is the off axis angle from the LED centerline where the luminous intensity is $\frac{1}{2}$ of the peak value.

Electrical and Thermal Characteristics

Table 3. Electrical and thermal characteristics for LUXEON TX at 700mA, T_j=85°C.

PART NUMBER	FORWARD VOLTAGE ^[1] (V _f)			TYPICAL TEMPERATURE COEFFICIENT OF FORWARD VOLTAGE (mV/°C) ^[2]	TYPICAL THERMAL RESISTANCE—JUNCTION TO SOLDER PAD (°C/W)
	MINIMUM	TYPICAL	MAXIMUM		
L1T2-xxxx000000000	2.5	2.8	3.0	-1.6	3.0

Notes for Table 3:

1. Lumileds maintains a tolerance of ±0.06V on forward voltage measurements.
2. Measured between 25°C and 110°C.

Absolute Maximum Ratings

Table 4. Absolute maximum ratings for LUXEON TX.

PARAMETER	MAXIMUM PERFORMANCE		
DC Forward Current ^[1,2]	1050mA	1200mA	1500mA
Peak Pulsed Forward Current ^[1,3]	1200mA	1350mA	1650mA
LED Junction Temperature ^[1] (DC & Pulse)	150°C	135°C	85°C
ESD Sensitivity (ANSI/ESDA/JEDEC JS-001-2012)	Class 3B		
Operating Case Temperature ^[1]	-40°C to 135°C		
LED Storage Temperature	-40°C to 135°C		
Soldering Temperature	JEDEC 020c 260°C		
Allowable Reflow Cycles	3		
Reverse Voltage (V _{reverse}) ^[4,5]	LUXEON LEDs are not designed to be driven in reverse bias		

Notes for Table 4:

1. Proper current derating must be observed to maintain the junction temperature below the maximum allowable junction temperature.
2. Residual periodic variations due to power conversion from alternating current (AC) to direct current (DC), also called "ripple," with frequencies ≥100Hz and amplitude ≤15% of the maximum allowable DC forward current are acceptable, assuming the average current throughout each cycle does not exceed the maximum allowable DC forward current at the corresponding maximum junction temperature.
3. Pulsed operation with a peak drive current equal to the stated peak pulsed forward current is acceptable if the pulse on-time is ≤5ms per cycle and the duty cycle is ≤50%.
4. Transient reverse voltages and surge currents due to electrical switching or supply interruptions are acceptable if these events do not last for more than 10ms, the amplitude of the reverse voltage does not exceed 5V and the reverse current is less than 220uA.
5. Max 5V reverse for up to 10s is an acceptable beginning of life, one time test condition.

Characteristic Curves

Spectral Power Distribution Characteristics

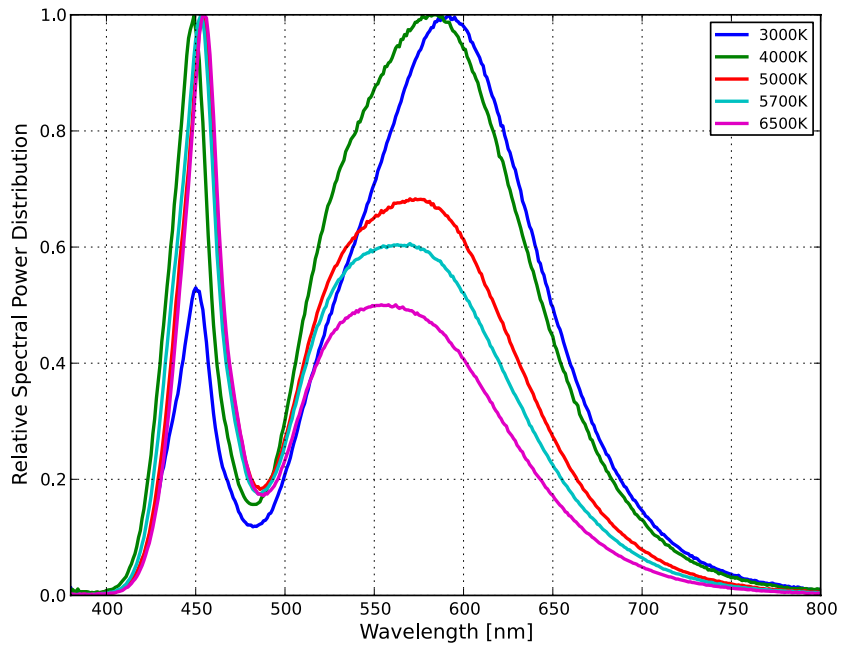

Figure 1a. Typical normalized power vs. wavelength for L1T2-xx70000000000 at 700mA, $T_j=85^\circ\text{C}$.

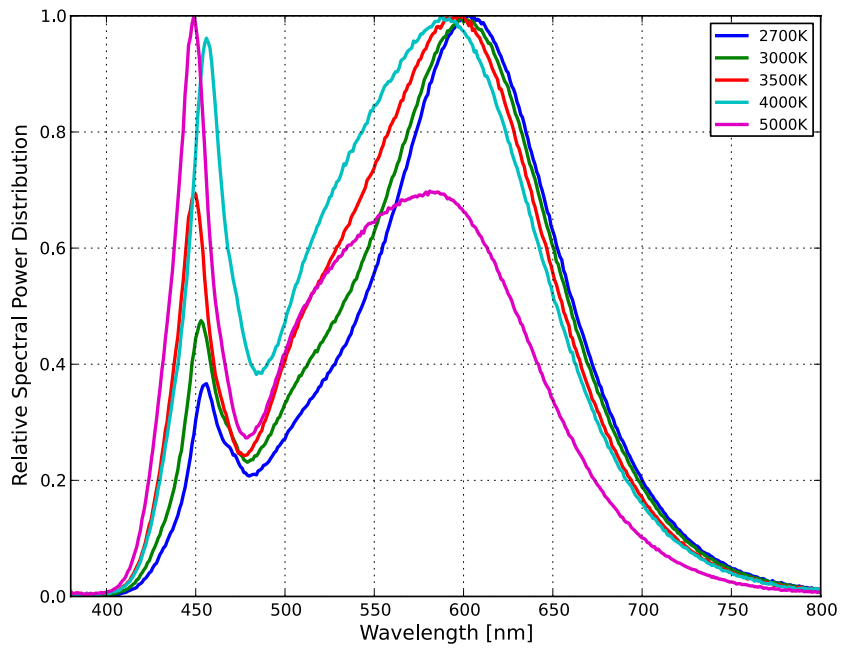

Figure 1b. Typical normalized power vs. wavelength for L1T2-xx80000000000 at 700mA, $T_j=85^\circ\text{C}$.

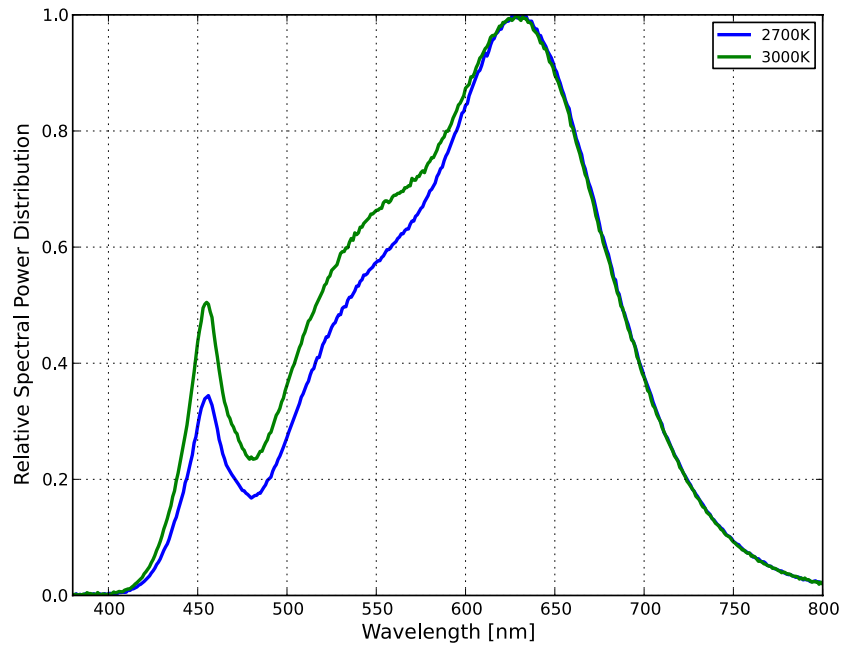

Figure 1c. Typical normalized power vs. wavelength for L1T2-xx900000000000 at 700mA, $T_j=85^\circ\text{C}$.

Light Output Characteristics

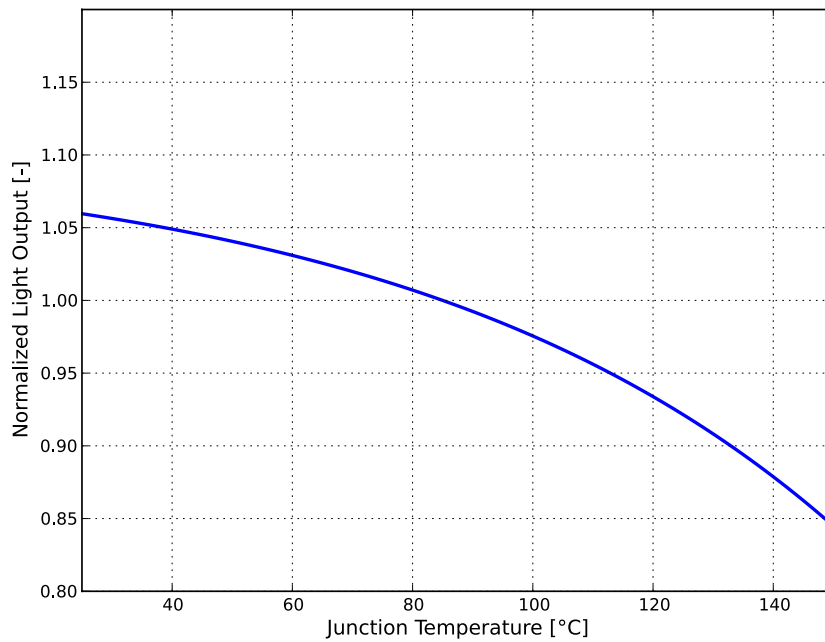

Figure 2. Typical normalized light output vs. junction temperature for LUXEON TX at 700mA.

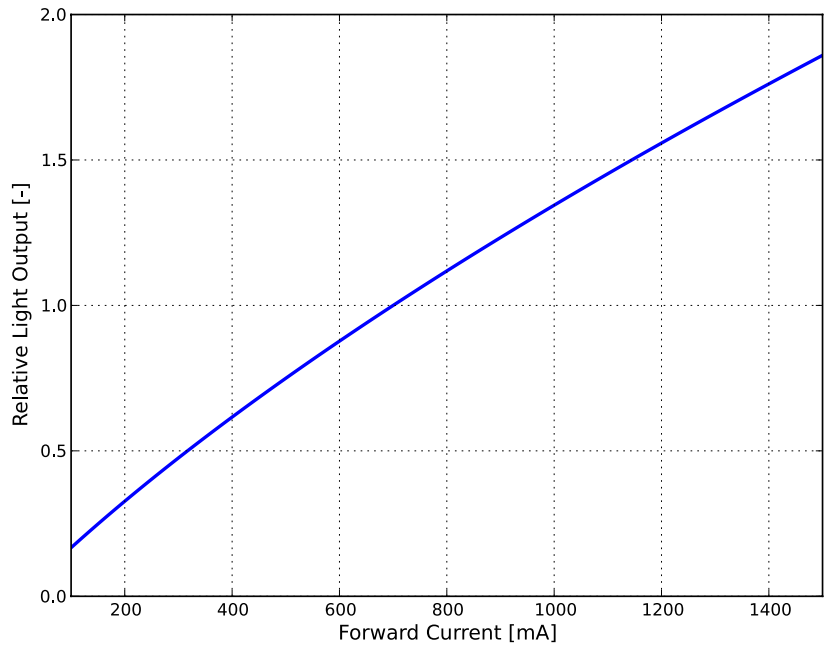

Figure 3. Typical normalized light output vs. forward current for LUXEON TX, $T_j=85^\circ\text{C}$.

Forward Current Characteristics

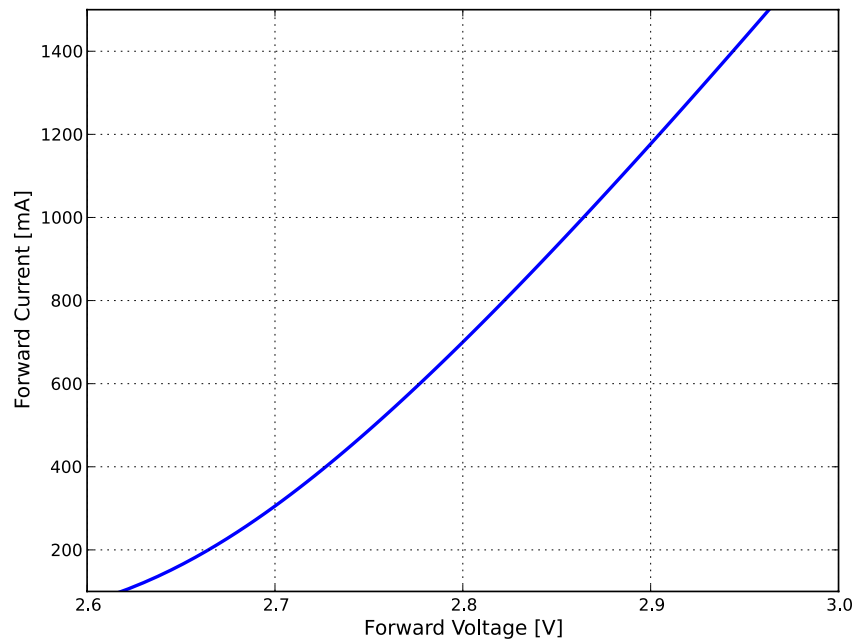

Figure 4. Typical forward current vs. forward voltage for LUXEON TX, $T_j=85^\circ\text{C}$.

Radiation Pattern Characteristics

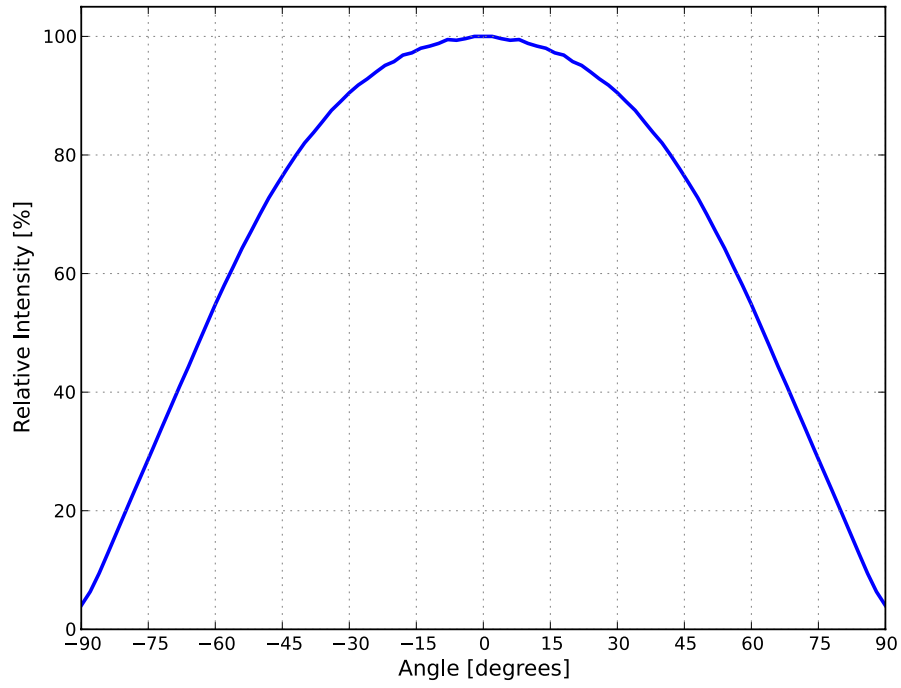

Figure 5. Typical radiation pattern for LUXEON TX at 700mA, $T_j=85^{\circ}\text{C}$.

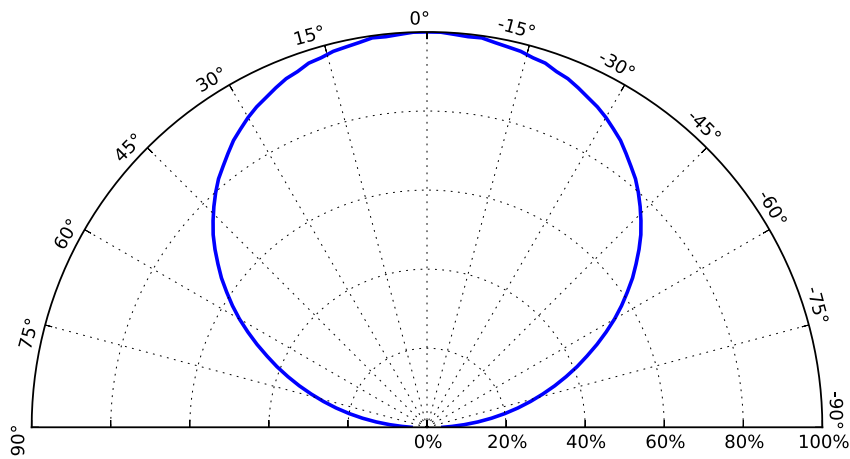

Figure 6. Typical polar radiation pattern for LUXEON TX at 700mA, $T_j=85^{\circ}\text{C}$.

Product Bin and Labeling Definitions

Decoding Product Bin Labeling

In the manufacturing of semiconductor products, there are variations in performance around the average values given in the technical datasheet. For this reason, Lumileds bins LED components for luminous flux or radiometric power, color point, peak or dominant wavelength and forward voltage.

LUXEON TX LEDs are labeled using a 4-digit alphanumeric CAT code following the format below:

A B C D

- A** – designates luminous flux bin (example: M=210 to 220 lumens, R=250 to 260 lumens)
- B** – designates correlated color temperature bin (1=6500K, 2=5700K, 3=5000K, 5=4000K, 6=3500K, 7=3000K, 8=2700K)
- C** – designates SDCM bin (3=3-step MacAdam ellipse, 5=5-step MacAdam ellipse)
- D** – designates forward voltage bin (example: P=2.50 to 2.75V, R=2.75 to 3.00V)

Therefore, a LUXEON TX with a lumen range of 210 to 220, color bin of 7 for 3000K parts, 3-step MacAdam ellipse 80CRI and a forward voltage range of 2.50 to 2.75 has the following CAT code:

M 7 3 P

Luminous Flux Bins

Table 5 lists the standard luminous flux bins for LUXEON TX emitters. Although several bins are outlined, product availability in a particular bin varies by production run and by product performance. Not all bins are available in all CCTs.

Table 5. Luminous flux bin definition for LUXEON TX.

BIN	LUMINOUS FLUX ⁽¹⁾ (lm)	
	MINIMUM	MAXIMUM
G	160	170
H	170	180
J	180	190
K	190	200
L	200	210
M	210	220
N	220	230
P	230	240
Q	240	250
R	250	260
S	260	270
T	270	280
U	280	290
V	290	300
W	300	310

Notes for Table 5:

1. Lumileds maintains a tolerance of $\pm 6.5\%$ on luminous flux measurements.

Color Bin Definitions

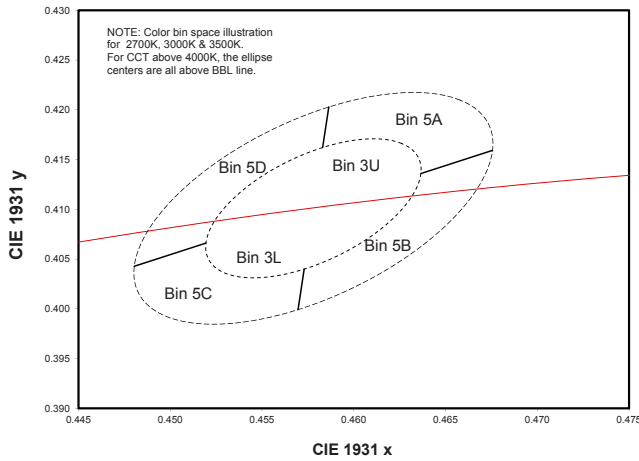

Figure 7. Color space definition for LUXEON TX.

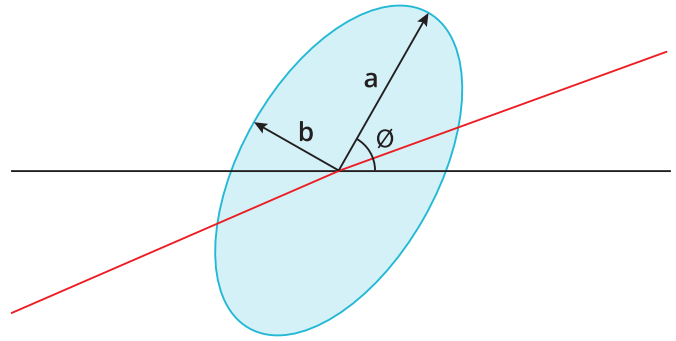

Figure 8. 3- and 5-step MacAdam ellipse illustration for Table 6.

Table 6. 3- and 5-step MacAdam ellipse color bin definitions for LUXEON TX.

NOMINAL CCT	COLOR SPACE	CENTER POINT ^[1] (cx, cy)	MAJOR AXIS, a	MINOR AXIS, b	ELLIPSE ROTATION ANGLE, θ
2700K	Single 3-step MacAdam ellipse	(0.4578, 0.4101)	0.00810	0.00420	53.7°
3000K	Single 3-step MacAdam ellipse	(0.4338, 0.4030)	0.00834	0.00408	53.2°
3500K	Single 3-step MacAdam ellipse	(0.4073, 0.3917)	0.00927	0.00414	54.0°
4000K	Single 3-step MacAdam ellipse	(0.3818, 0.3797)	0.00939	0.00402	53.7°
5000K	Single 3-step MacAdam ellipse	(0.3447, 0.3553)	0.00822	0.00354	59.6°
2700K	Single 5-step MacAdam ellipse	(0.4578, 0.4101)	0.01350	0.00700	53.7°
3000K	Single 5-step MacAdam ellipse	(0.4338, 0.4030)	0.01390	0.00680	53.2°
3500K	Single 5-step MacAdam ellipse	(0.4073, 0.3917)	0.01545	0.00690	54.0°
4000K	Single 5-step MacAdam ellipse	(0.3818, 0.3797)	0.01565	0.00670	53.7°
5000K	Single 5-step MacAdam ellipse	(0.3447, 0.3553)	0.01370	0.00590	59.6°
5700K	Single 5-step MacAdam ellipse	(0.3287, 0.3417)	0.01243	0.00533	59.1°
6500K	Single 5-step MacAdam ellipse	(0.3123, 0.3282)	0.01115	0.00475	58.6°

Notes for Table 6:

1. Lumileds maintains a tolerance of ± 0.005 on x and y color coordinates in the CIE 1931 color space.

Table 7. Correlated color temperature bin definitions for LUXEON TX.

BIN	CCT
1	6500K
2	5700K
3	5000K
5	4000K
6	3500K
7	3000K
8	2700K

Table 8. MacAdam ellipse color bin definitions for LUXEON TX.

BIN	SDCM
3	3-step MacAdam ellipse (80, 85, 90CRI)
U	3-step MacAdam ellipse (80, 85, 90CRI)
L	3-step MacAdam ellipse (80, 85, 90CRI)
5	5-step MacAdam ellipse (70CRI)
A	5-step MacAdam ellipse (80, 85, 90CRI)
B	5-step MacAdam ellipse (80, 85, 90CRI)
C	5-step MacAdam ellipse (80, 85, 90CRI)
D	5-step MacAdam ellipse (80, 85, 90CRI)

Forward Voltage Bins

Table 9. Forward voltage bin definitions for LUXEON TX.

BIN	FORWARD VOLTAGE ⁽¹⁾ (V _f)	
	MINIMUM	MAXIMUM
P	2.50	2.75
R	2.75	3.00
X	2.65	2.85
Y	2.85	3.00

Notes for Table 9:

1. Lumileds maintains a tolerance of $\pm 0.06V$ on forward voltage measurements.

Mechanical Dimensions

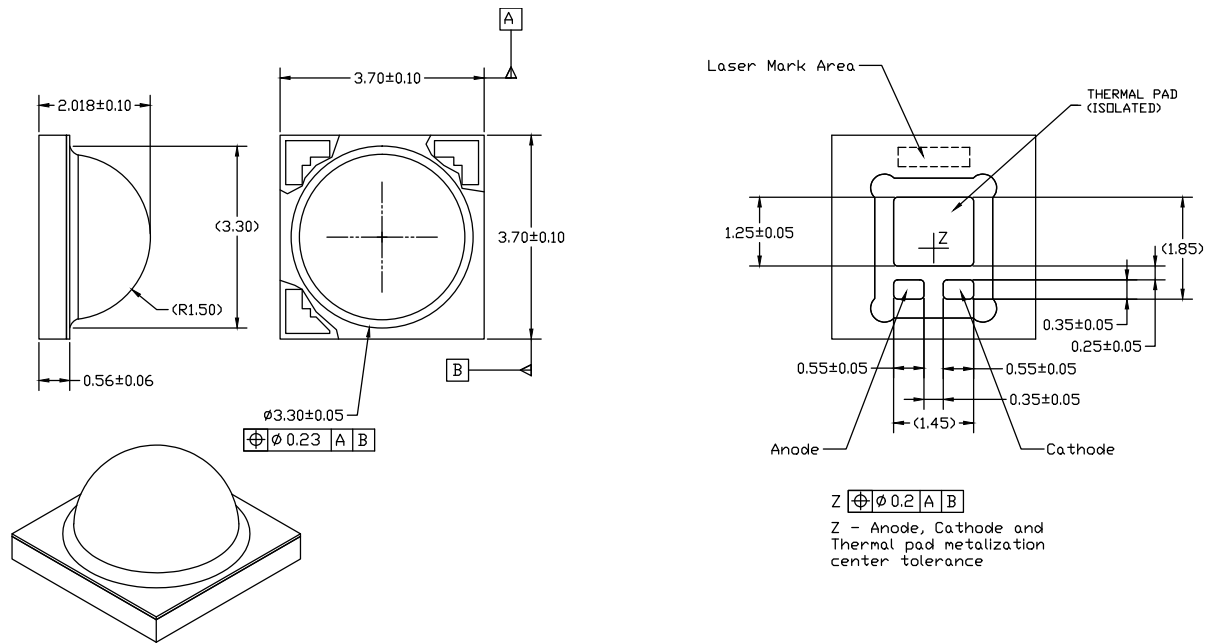

Figure 9. Mechanical dimensions for LUXEON TX.

Notes for Figure 9:

1. Drawings are not to scale.
2. All dimensions are in millimeters.
3. Do not handle the device by the dome. Excessive force on the dome may damage the dome itself or the interior of the device.

Reflow Soldering Guidelines



Figure 10. Visualization of the acceptable reflow temperature profile as specified in Table 10.

Table 10. Reflow profile characteristics for LUXEON TX.

PROFILE FEATURE	LEAD-FREE ASSEMBLY
Preheat Minimum Temperature (T_{smin})	150°C
Preheat Maximum Temperature (T_{smax})	200°C
Preheat Time (t_{smin} to t_{smax})	60 to 120 seconds
Ramp-Up Rate (T_L to T_p)	3°C / second maximum
Liquidus Temperature (T_L)	217°C
Time Maintained Above Temperature T_L (t_t)	60 to 150 seconds
Peak / Classification Temperature (T_p)	260°C
Time Within 5°C of Actual Temperature (t_p)	20 to 40 seconds
Ramp-Down Rate (T_p to T_L)	6°C / second maximum
Time 25°C to Peak Temperature	8 minutes maximum

JEDEC Moisture Sensitivity

Table 11. Moisture sensitivity levels for LUXEON TX.

LEVEL	FLOOR LIFE		SOAK REQUIREMENTS STANDARD	
	TIME	CONDITIONS	TIME	CONDITIONS
1	Unlimited	≤30°C / 85% RH	168 Hours +5 / -0	85°C / 85% RH

Solder Pad Design

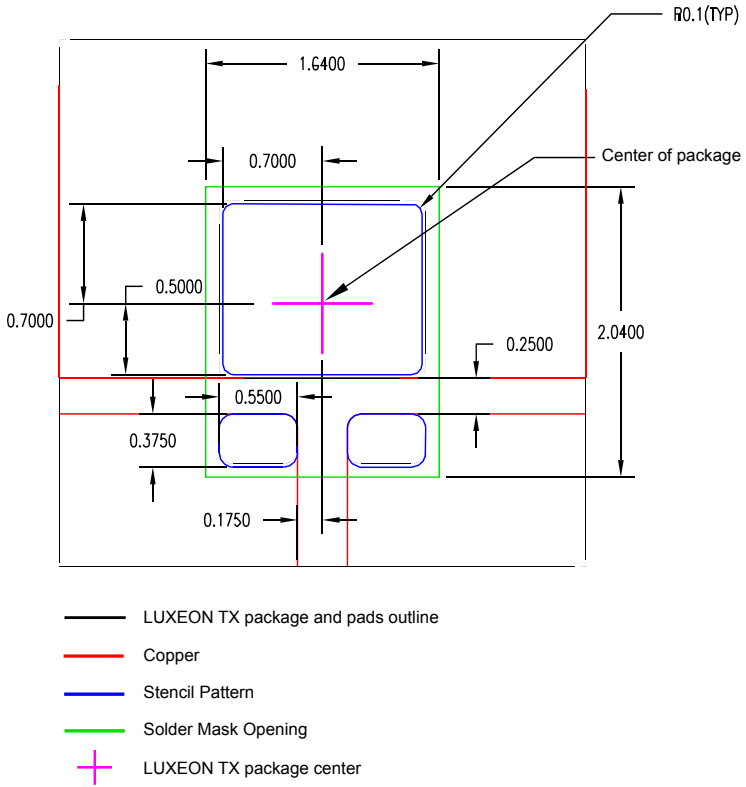

Figure 11. Recommended PCB solder pad layout for LUXEON TX.

Notes for Figure 11:
 1. Drawings are not to scale.
 2. All dimensions are in millimeters.

Packaging Information

Pocket Tape Dimensions

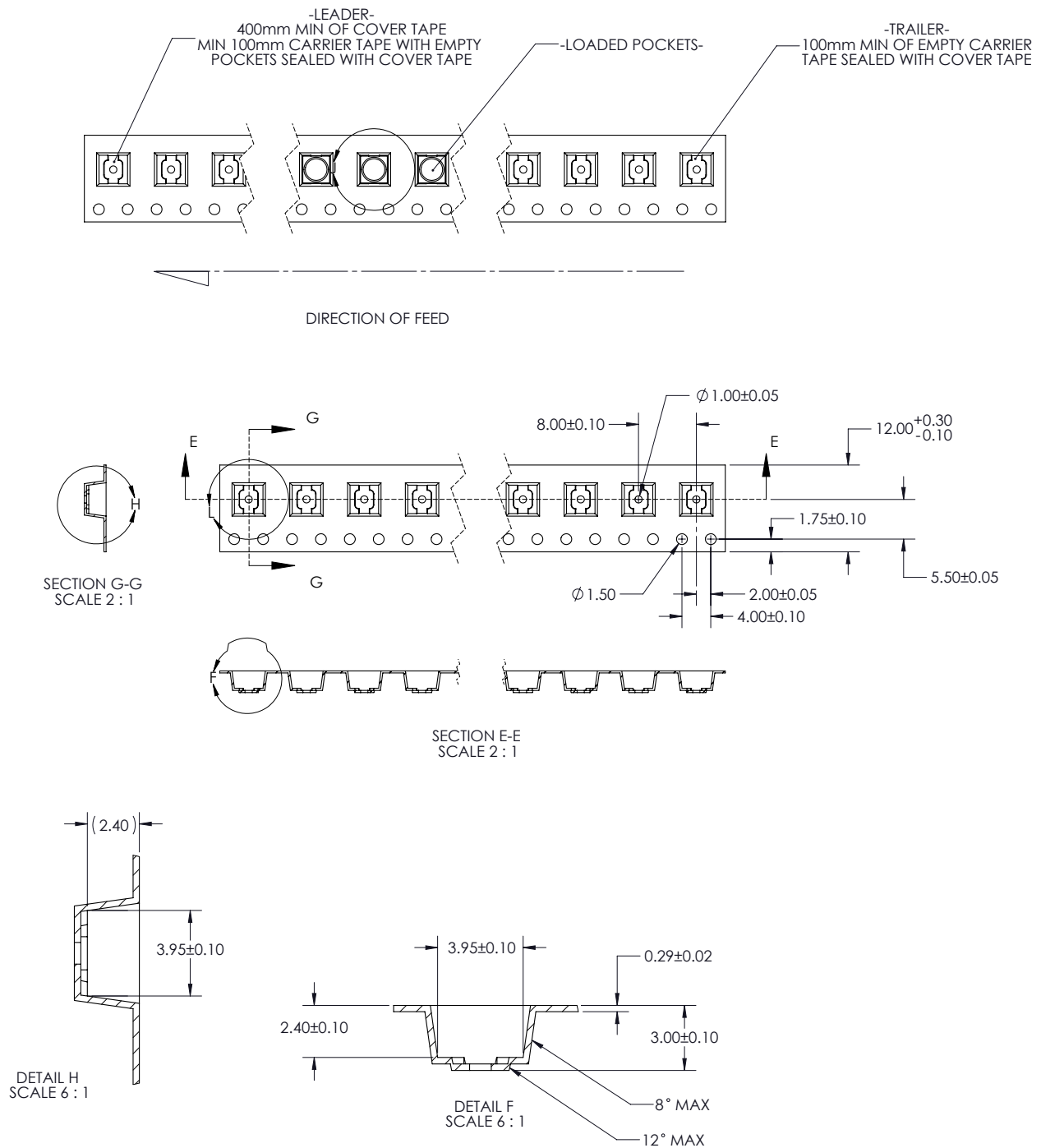

Figure 12. Tape dimensions for LUXEON TX.

Notes for Figure 12:

1. Drawings are not to scale.
2. All dimensions are in millimeters.

Reel Dimensions

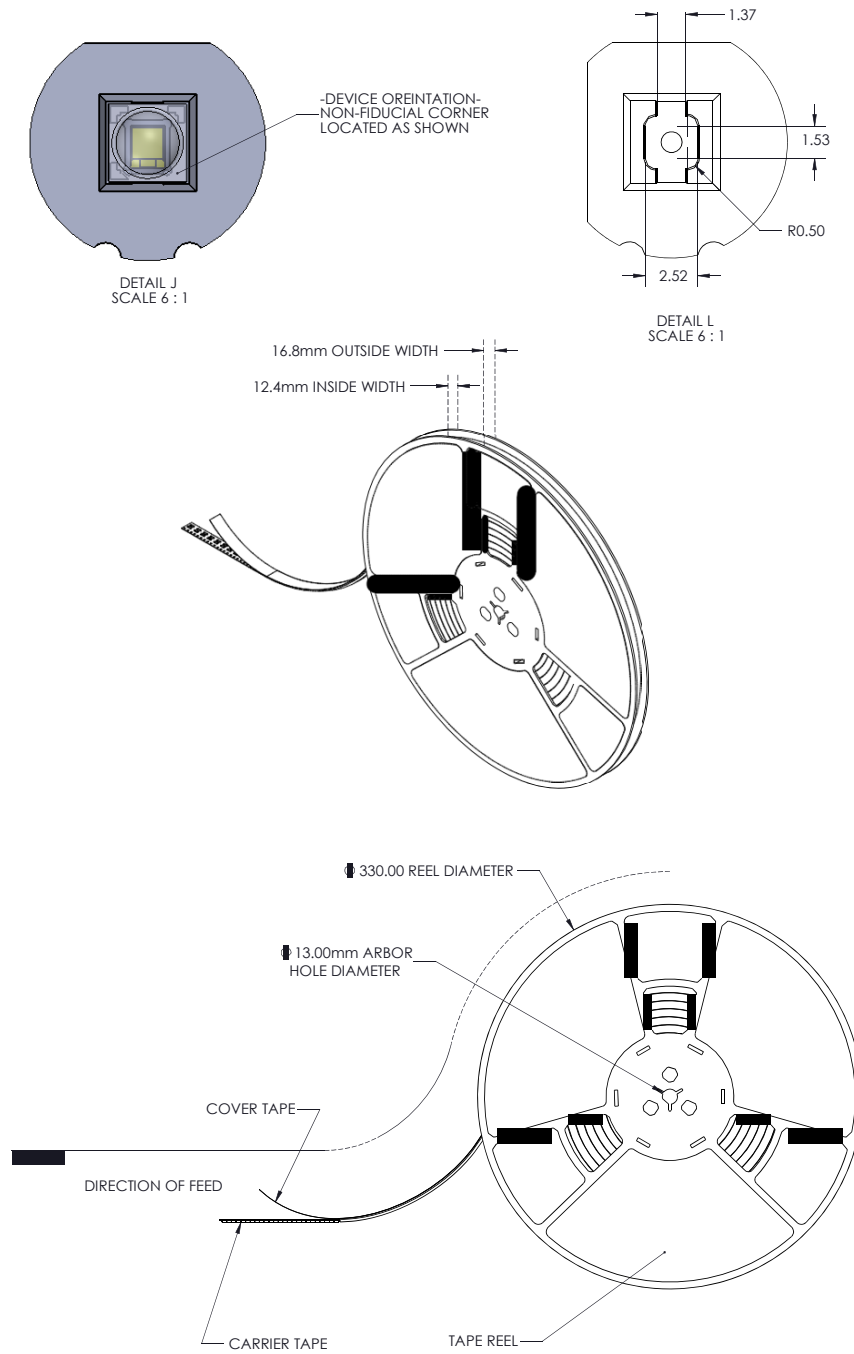

Figure 13. Reel dimensions for LUXEON TX.

- Notes for Figure 13:
1. Drawings are not to scale.
 2. All dimensions are in millimeters.

About Lumileds

Lumileds is the global leader in light engine technology. The company develops, manufactures and distributes groundbreaking LEDs and automotive lighting products that shatter the status quo and help customers gain and maintain a competitive edge.

With a rich history of industry “firsts,” Lumileds is uniquely positioned to deliver lighting advancements well into the future by maintaining an unwavering focus on quality, innovation and reliability.

To learn more about our portfolio of light engines, visit lumileds.com.



©2016 Lumileds Holding B.V. All rights reserved.
LUXEON is a registered trademark of the Lumileds Holding B.V.
in the United States and other countries.

lumileds.com

Neither Lumileds Holding B.V. nor its affiliates shall be liable for any kind of loss of data or any other damages, direct, indirect or consequential, resulting from the use of the provided information and data. Although Lumileds Holding B.V. and/or its affiliates have attempted to provide the most accurate information and data, the materials and services information and data are provided “as is,” and neither Lumileds Holding B.V. nor its affiliates warrants or guarantees the contents and correctness of the provided information and data. Lumileds Holding B.V. and its affiliates reserve the right to make changes without notice. You as user agree to this disclaimer and user agreement with the download or use of the provided materials, information and data.