



USB Current-Limited Switches with Fault Blanking

MAX1693/(MAX1693H)/MAX1694

General Description

The MAX1693/(MAX1693H)/MAX1694 are current-limited, 60mΩ switches with built-in fault blanking. Their accurate preset current limit of 0.7A to 1.0A makes them ideally suited for USB applications. Their low quiescent supply current (14μA) and shutdown current (1μA) conserve battery power in portable applications. The MAX1693/(MAX1693H)/MAX1694 operate with inputs from 2.7V to 5.5V, making them ideal for both 3V and 5V systems.

A fault signal notifies the microprocessor that the internal current limit has been reached. A 10ms fault-blanking feature allows momentary faults (such as those caused when hot-swapping into a capacitive load) to be ignored, thus preventing false alarms to the host system. This fault blanking also prevents a fault signal from being issued when the device is powering up.

In the MAX1693/(MAX1693H), an output overcurrent condition causes the switch to current limit at 0.7A to 1.0A and $\overline{\text{FAULT}}$ to go low after the 10ms blanking period. When the overcurrent condition is removed, $\overline{\text{FAULT}}$ returns to its high-impedance state. In the MAX1694, any overcurrent longer than 10ms will latch the switch open and set $\overline{\text{FAULT}}$ low. The latch is cleared by cycling the $\overline{\text{ON}}$ input or by powering up the device again. This feature saves power by preventing the device from thermally cycling on and off in case of a persistent short-circuit condition.

The MAX1693/(MAX1693H)/MAX1694 have several safety features to ensure that the USB port is protected. Built-in thermal-overload protection limits power dissipation and junction temperatures. All devices have accurate internal current-limiting circuitry to protect the input supply against overload. They are available in space-saving 10-pin μMAX packages.

Pin Configuration

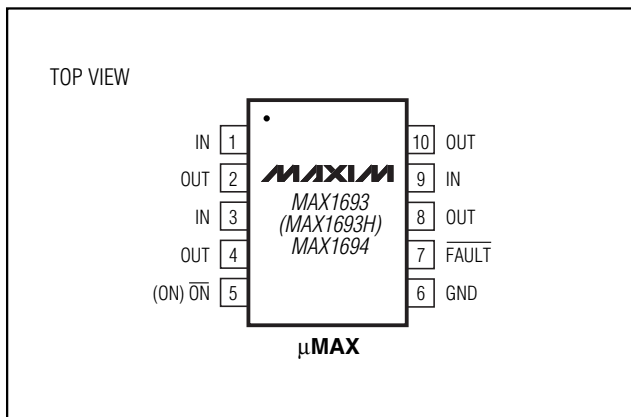

Features

- ◆ Accurate Current Limit (0.7A min, 1.0A max)
- ◆ Guaranteed 0.75A Short-Circuit Protection
- ◆ 10ms Internal Fault-Blanking Timeout
- ◆ No Fault Signal During Power-Up
- ◆ Latched $\overline{\text{FAULT}}$ Output Turns Off Power Switch (MAX1694)
- ◆ Thermal Shutdown Protection
- ◆ 2.7V to 5.5V Supply Range
- ◆ 14μA Supply Current
- ◆ Small 10-Pin μMAX Package
- ◆ UL Recognized—#E211935

Applications

- USB Ports and Hubs
- Notebook Computers
- Portable Equipment
- Docking Stations
- Hot Plug-In Power Supplies
- Battery-Charger Circuits

Ordering Information

PART	TEMP RANGE	PIN-PACKAGE
MAX1693EUB	-40°C to +85°C	10 μMAX
MAX1693HEUB	-40°C to +85°C	10 μMAX
MAX1694EUB	-40°C to +85°C	10 μMAX

Typical Operating Circuit

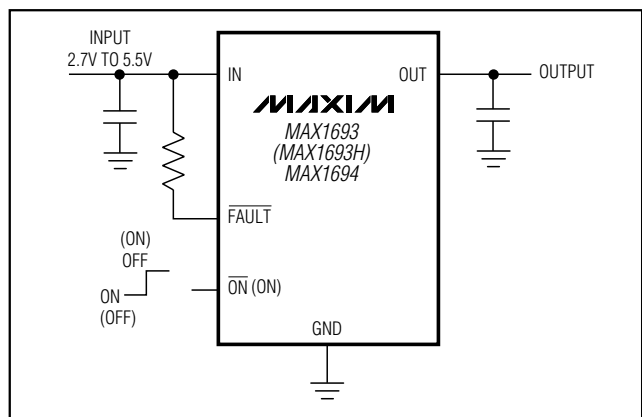

USB Current-Limited Switches with Fault Blanking

ABSOLUTE MAXIMUM RATINGS

IN, $\overline{\text{ON}}$ (ON), $\overline{\text{FAULT}}$ to GND -0.3V to +6V
 OUT to GND -0.3V to ($V_{\text{IN}} + 0.3\text{V}$)
 Maximum Continuous Switch Current 1.2A (internally limited)
 OUT Short Circuit to GND Continuous
 Continuous Power Dissipation ($T_{\text{A}} = +70^{\circ}\text{C}$)
 10-Pin μMAX (derate 5.6mW/ $^{\circ}\text{C}$ above +70 $^{\circ}\text{C}$) 444mW

Operating Temperature Range
 MAX1693EUB/MAX1693HEUB/
 MAX1694EUB -40 $^{\circ}\text{C}$ to +85 $^{\circ}\text{C}$
 Storage Temperature Range -65 $^{\circ}\text{C}$ to +150 $^{\circ}\text{C}$
 Lead Temperature (soldering, 10s) +300 $^{\circ}\text{C}$

Stresses beyond those listed under "Absolute Maximum Ratings" may cause permanent damage to the device. These are stress ratings only, and functional operation of the device at these or any other conditions beyond those indicated in the operational sections of the specifications is not implied. Exposure to absolute maximum rating conditions for extended periods may affect device reliability.

ELECTRICAL CHARACTERISTICS

($V_{\text{IN}} = +5\text{V}$, $T_{\text{A}} = 0^{\circ}\text{C}$ to +85 $^{\circ}\text{C}$, unless otherwise noted. Typical values are at $T_{\text{A}} = +25^{\circ}\text{C}$.)

PARAMETER	SYMBOL	CONDITIONS		MIN	TYP	MAX	UNITS
Operating Voltage	V_{IN}			2.7		5.5	V
Quiescent Current	I_{Q}	$V_{\overline{\text{ON}}}(\text{ON}) = \text{GND}$ (V_{IN}) $I_{\text{OUT}} = 0$	Timer not running		14	25	μA
			Timer running		35		
Off-Supply Current		$V_{\overline{\text{ON}}}(\text{ON}) = V_{\text{IN}} = V_{\text{OUT}} = 5.5\text{V}$ ($V_{\text{ON}} = \text{GND}$)			0.001	1	μA
Undervoltage Lockout	UVLO	Rising edge, 100mV hysteresis		2.0		2.6	V
Off-Switch Leakage		$V_{\overline{\text{ON}}}(\text{ON}) = V_{\text{IN}}$ (GND) $V_{\text{IN}} = 5.5\text{V}$, $V_{\text{OUT}} = \text{GND}$	$T_{\text{A}} = +25^{\circ}\text{C}$		0.01	2	μA
			$T_{\text{A}} = 0^{\circ}\text{C}$ to +85 $^{\circ}\text{C}$			15	
On-Resistance	R_{ON}	$T_{\text{A}} = +25^{\circ}\text{C}$ $T_{\text{A}} = 0^{\circ}\text{C}$ to +85 $^{\circ}\text{C}$	$V_{\text{IN}} = 4.4\text{V}$ to 5.5V		60	90	m Ω
			$V_{\text{IN}} = 4.4\text{V}$ to 5.5V			125	
			$V_{\text{IN}} = 3\text{V}$		72	150	
Current Limit	I_{LIMIT}	(Note 1)		700	850	1000	mA
Continuous Short-Circuit Current Limit	I_{SC}	OUT shorted to GND, MAX1693/(MAX1693H) only (Note 2)			500	700	mA
$\overline{\text{ON}}$ (ON) Input Logic Low Voltage	V_{IL}	$V_{\text{IN}} = 2.7\text{V}$ to 5.5V				0.8	V
$\overline{\text{ON}}$ (ON) Input Logic High Voltage	V_{IH}	$V_{\text{IN}} = 2.7\text{V}$ to 3.6V		2			V
		$V_{\text{IN}} = 3.7\text{V}$ to 5.5V		2.4			
$\overline{\text{ON}}$ (ON) Input Leakage		$V_{\overline{\text{ON}}}(\text{ON}) = V_{\text{IN}}$ or GND				± 1	μA
$\overline{\text{FAULT}}$ Output Logic Low Voltage	V_{OL}	$I_{\text{SINK}} = 1\text{mA}$, $V_{\text{IN}} = 3\text{V}$				0.4	V
$\overline{\text{FAULT}}$ Output High Leakage Current		$V_{\text{IN}} = V_{\overline{\text{FAULT}}} = 5.5\text{V}$				1	μA
Fault-Blanking Timeout Period	t_{FB}	From overcurrent condition to $\overline{\text{FAULT}}$ assertion		7	10	13	ms
Start-Up Time		$V_{\text{IN}} = 5\text{V}$, $C_{\text{OUT}} = 150\mu\text{F}$, $R_{\text{L}} = 15\Omega$, from $\overline{\text{ON}}$ (ON) driven low (high) to 50% full V_{OUT}			1		ms
Switch Turn-On Time	t_{ON}	$I_{\text{LOAD}} = 400\text{mA}$			80	200	μs
Switch Turn-Off Time	t_{OFF}	$I_{\text{LOAD}} = 400\text{mA}$		3	6	20	μs
Thermal Shutdown Threshold					165		$^{\circ}\text{C}$

USB Current-Limited Switches with Fault Blanking

MAX1693/(MAX1693H)/MAX1694

ELECTRICAL CHARACTERISTICS

($V_{IN} = +5V$, $T_A = -40^{\circ}C$ to $+85^{\circ}C$, unless otherwise noted.) (Note 3)

PARAMETER	SYMBOL	CONDITIONS	MIN	TYP	MAX	UNITS
Operating Voltage	V_{IN}		3		5.5	V
Quiescent Current	I_Q	$\overline{ON} (ON) = GND (GND)$, $I_{OUT} = 0$, timer not running			25	μA
Off-Supply Current		$\overline{ON} (ON) = V_{IN} = V_{OUT} = 5.5V$ ($V_{ON} = GND$)			2	μA
Undervoltage Lockout	UVLO	Rising edge, 100mV hysteresis	2.0		2.9	V
Off-Switch Leakage		$\overline{ON} (ON) = V_{IN} = 5.5V$, $V_{OUT} = GND$ ($V_{ON} = GND$)			15	μA
On-Resistance	R_{ON}	$V_{IN} = 4.4V$ to $5.5V$			125	$m\Omega$
		$V_{IN} = 3V$			150	
Current Limit	I_{LIMIT}	(Note 1)	640		1060	mA
Continuous Short-Circuit Current Limit		OUT shorted to GND, MAX1693/(MAX1693H) only (Note 2)			750	mA
$\overline{ON} (ON)$ Input Logic Low Voltage	V_{IL}	$V_{IN} = 3V$ to $5.5V$			0.8	V
$\overline{ON} (ON)$ Input Logic High Voltage	V_{IH}	$V_{IN} = 3V$ to $3.6V$	2			V
		$V_{IN} = 3.7V$ to $5.5V$	2.4			
$\overline{ON} (ON)$ Input Leakage		$\overline{ON} (ON) = V_{IN}$ or GND			± 1	μA
\overline{FAULT} Output Logic Low Voltage	V_{OL}	$I_{SINK} = 1mA$, $V_{IN} = 3V$			0.4	V
\overline{FAULT} Output High Leakage Current		$V_{IN} = V_{\overline{FAULT}} = 5.5V$			1	μA
Fault-Blanking Timeout Period	t_{FB}	From overcurrent condition to \overline{FAULT} assertion	6		14	ms
Switch Turn-On Time	t_{ON}	$I_{LOAD} = 400mA$			200	μs
Switch Turn-Off Time	t_{OFF}	$I_{LOAD} = 400mA$	1		20	μs

Note 1: MAX1693/(MAX1693H)'s current limit is tested by forcing V_{OUT} to 4.5V. The MAX1694's current limit is tested by increasing the output current until the switch is latched off.

Note 2: This specification applies to the MAX1693/(MAX1693H) only. The MAX1694 latches the switch off under a sustained (>10ms) short-circuit condition.

Note 3: Specifications to $-40^{\circ}C$ are guaranteed by design, not production tested.

USB Current-Limited Switches with Fault Blanking

Typical Operating Characteristics

($V_{IN} = +5V$, $T_A = +25^\circ C$, unless otherwise noted.)

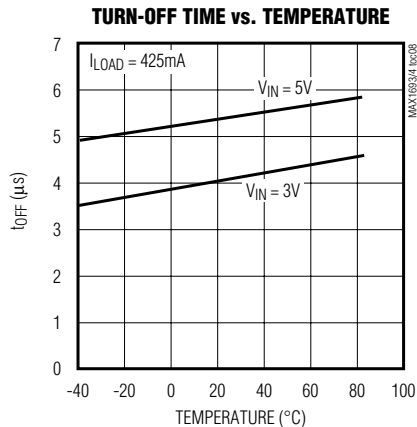
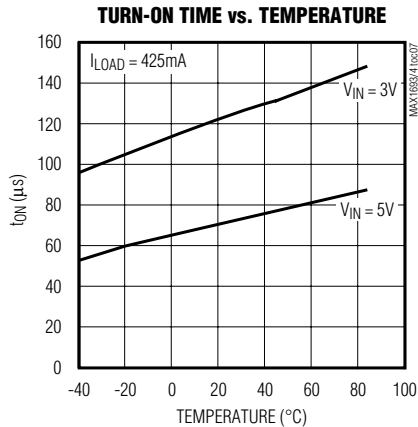
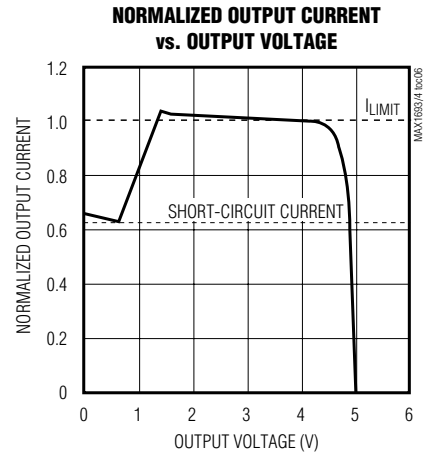
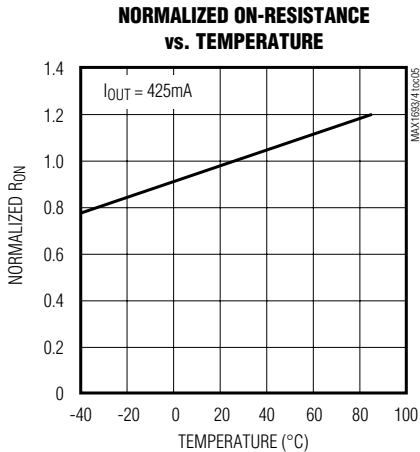
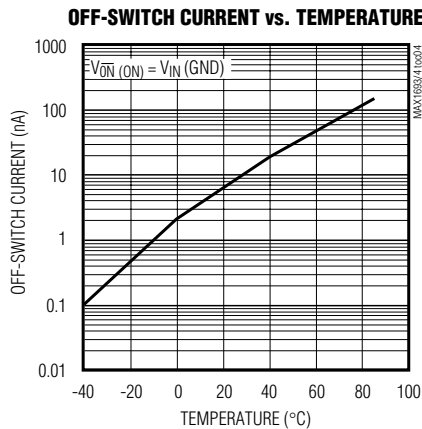
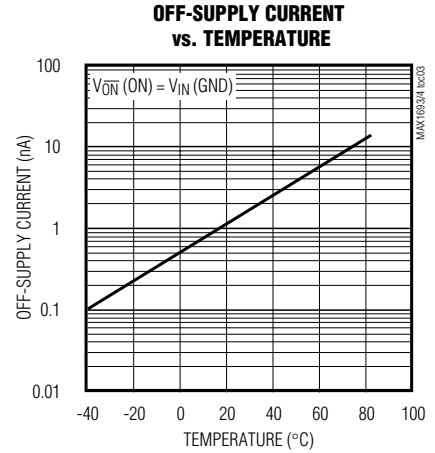
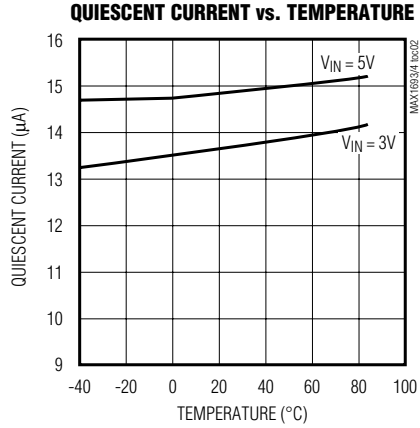
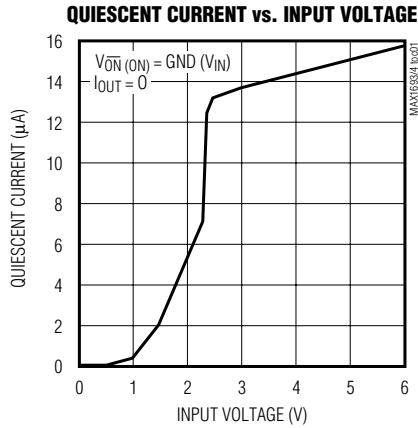

USB Current-Limited Switches with Fault Blanking

Typical Operating Characteristics (continued)

($V_{IN} = +5V$, $T_A = +25^\circ C$, unless otherwise noted.)

MAX1693/(MAX1693H)/MAX1694

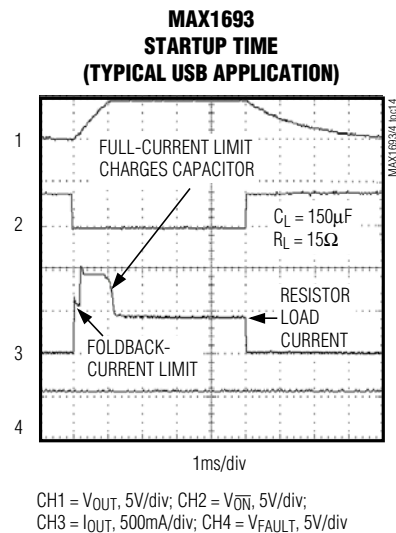
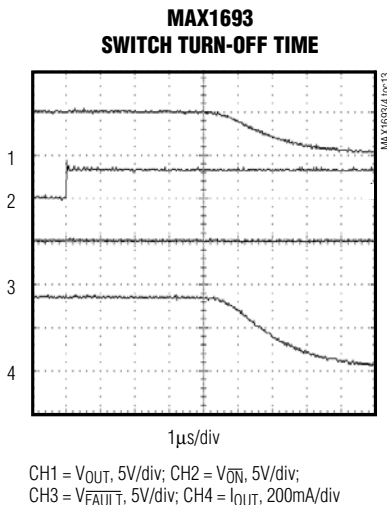
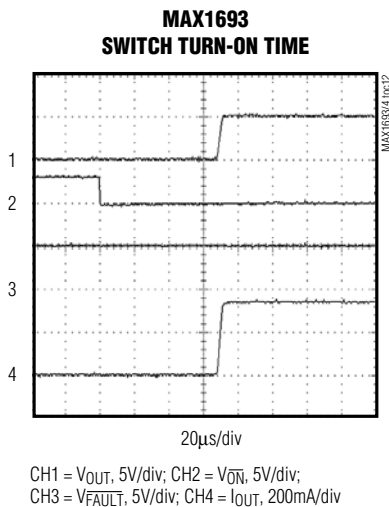
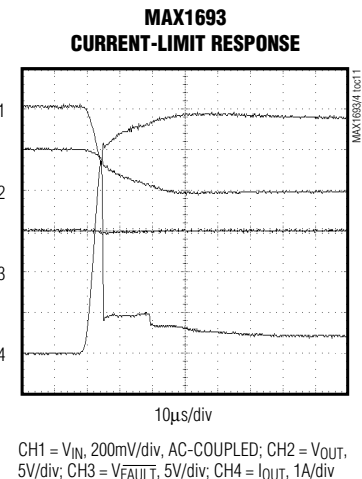
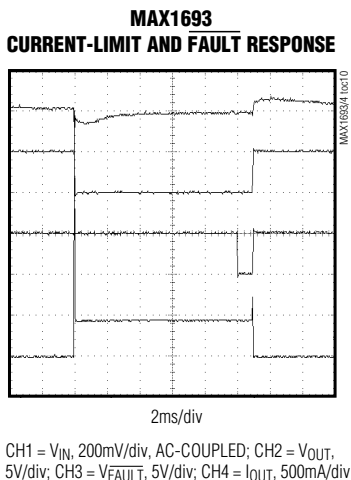
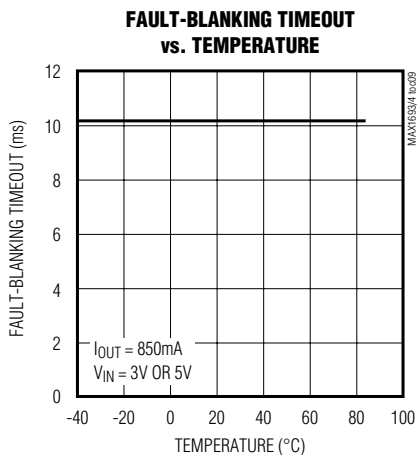

USB Current-Limited Switches with Fault Blanking

Typical Operating Characteristics (continued)

($V_{IN} = +5V$, $T_A = +25^\circ C$, unless otherwise noted.)

**MAX1694
OVERCURRENT TO FAULT
AND SWITCH LATCHED OFF**

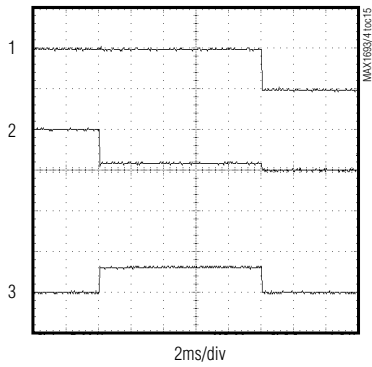

CH1 = V_{FAULT} , 5V/div; CH2 = I_{OUT} , 5V/div;
CH3 = I_{OUT} , 1A/div

**MAX1693H
SWITCH TURN-ON TIME**

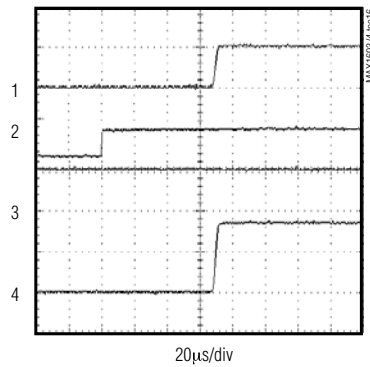

CH1 = V_{OUT} , 5V/div; CH2 = V_{ON} , 5V/div;
CH3 = V_{FAULT} , 5V/div; CH4 = I_{OUT} , 200mA/div

**MAX1693H
SWITCH TURN-OFF TIME**

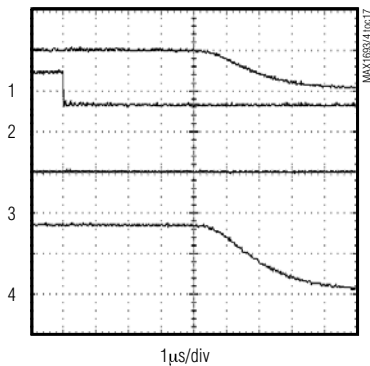

CH1 = V_{OUT} , 5V/div; CH2 = V_{ON} , 5V/div;
CH3 = V_{FAULT} , 5V/div; CH4 = I_{OUT} , 200mA/div

**MAX1693H
STARTUP TIME
(TYPICAL USB APPLICATION)**

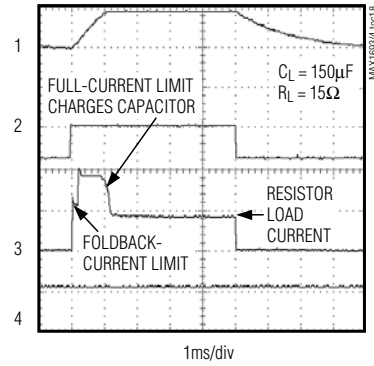

CH1 = V_{OUT} , 5V/div; CH2 = V_{ON} , 5V/div;
CH3 = I_{OUT} , 500mA/div; CH4 = V_{FAULT} , 5V/div

USB Current-Limited Switches with Fault Blanking

Pin Description

PIN	NAME	FUNCTION
1, 3, 9	IN	Input. P-channel MOSFET source. Connect all IN pins together and bypass with a 1 μ F ceramic capacitor to ground.
2, 4, 8, 10	OUT	Switch Output. P-channel MOSFET drain. Connect all OUT pins together and bypass with a 0.1 μ F capacitor to ground.
5	$\overline{\text{ON}}$ (ON)	Active-Low (High) Switch On Input. A logic low (high) turns the switch on.
6	GND	Ground
7	$\overline{\text{FAULT}}$	Fault-Indicator Output. This open-drain output goes low when the device is in thermal shutdown, undervoltage lockout, or on a sustained (>10ms) current-limit condition. For the MAX1694 only, this output latches low when asserted, and the power switch is turned off until the latch is reset.

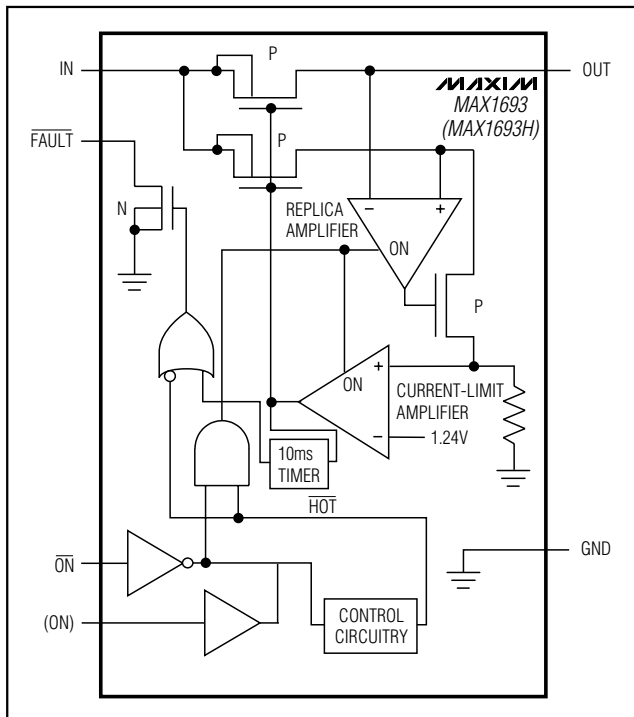

Figure 1. MAX1693 Functional Diagram

Detailed Description

The MAX1693/(MAX1693H)/MAX1694 P-channel MOSFET power switches limit output current to 0.7A min to 1.0A max. When the output current is increased beyond the current limit (I_{LIMIT}), the current also increases through the replica switch ($I_{OUT}/6500$). The current-limit error amplifier compares the voltage to the internal 1.24V reference and regulates the current back to the I_{LIMIT} .

These switches are not bidirectional; therefore, the input voltage must be higher than the output voltage.

Continuous Short-Circuit Protection

The MAX1693/(MAX1693H)/MAX1694 are foldback short circuit-protected switches. In the event of an output short-circuit or current-overload condition, the current through the switch is foldback-current limited to 500mA continuous for the MAX1693. For the MAX1694, if the short circuit lasts longer than 10ms, the switch is latched off.

Thermal Shutdown

The MAX1693/(MAX1693H)/MAX1694 feature thermal shutdown. The switch turns off and the $\overline{\text{FAULT}}$ output goes low immediately (no fault blanking) when the junction temperature exceeds +165°C. The MAX1694 remains latched with the switch off and the $\overline{\text{FAULT}}$ output low. When the MAX1693/(MAX1693H) cools 20°C, the switch turns back on. If the fault short-circuit condition is not removed, the switch will cycle on and off, resulting in a pulsed output.

$\overline{\text{FAULT}}$ Indicator

The MAX1693/(MAX1693H)/MAX1694 provide a fault output ($\overline{\text{FAULT}}$). A 100k Ω pullup resistor from $\overline{\text{FAULT}}$ to IN provides a logic control signal. This open-drain output goes low when any of the following conditions occur:

- The input voltage is below the undervoltage-lockout (UVLO) threshold.
- The die temperature exceeds the thermal shutdown temperature limit of +165°C.
- The device is in current limit and the 10ms fault-blanking period is exceeded.

USB Current-Limited Switches with Fault Blanking

Fault Blanking

The MAX1693/(MAX1693H)/MAX1694 feature 10ms fault blanking. Fault blanking allows current-limit faults, including momentary short-circuit faults that occur when hot-swapping a capacitive load, and also ensures that no fault is issued during power-up. When a load transient causes the device to enter current limit, an internal counter starts. If the load fault persists beyond the 10ms fault-blanking timeout, the $\overline{\text{FAULT}}$ output asserts low. Ensure that the MAX1693/(MAX1693H)/MAX1694's input is adequately bypassed to prevent input glitches from triggering spurious $\overline{\text{FAULT}}$ outputs. Input voltage glitches less than 150mV will not cause a spurious $\overline{\text{FAULT}}$ output. Load-transient faults less than 10ms (typ) will not cause a $\overline{\text{FAULT}}$ output assertion.

Only current-limit faults are blanked. Die overtemperature faults and input voltage droops below the UVLO threshold will cause an immediate fault output.

Fault Latching (MAX1694 Only)

The MAX1694 features a latched $\overline{\text{FAULT}}$ output. Whenever the $\overline{\text{FAULT}}$ output is activated, it latches the $\overline{\text{FAULT}}$ output low and also turns the switch off. To clear the latch, either cycle the $\overline{\text{ON}}$ input or cycle the input voltage below UVLO.

Applications Information

Input Capacitor

To limit the input voltage drop during momentary output short-circuit conditions, connect a capacitor from IN to GND. A 1 μ F ceramic capacitor will be adequate for most applications; however, higher capacitor values will further reduce the voltage drop at the input (see Figure 2).

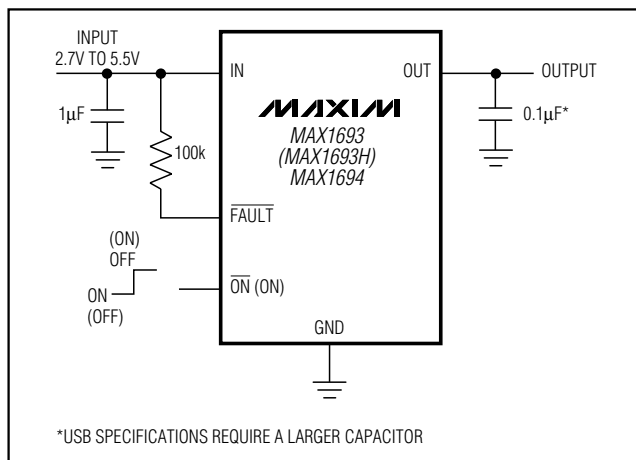

Figure 2. Typical Application Circuit

Output Capacitor

Connect a 0.1 μ F capacitor from OUT to GND. This capacitor helps prevent inductive parasitics from pulling OUT negative during turn-off.

Layout and Thermal Dissipation

To optimize the switch-response time to output short-circuit conditions, it is very important to keep all traces as short as possible to reduce the effect of undesirable parasitic inductance. Place input and output capacitors as close to the device as possible (no more than 5mm). All IN and all OUT pins must be connected with short traces to the power bus. Wide power bus planes will provide superior heat dissipation through the switch IN and OUT pins. Figure 3 shows suggested pin connections for a single-layer board.

Under normal operating conditions, the package can dissipate and channel heat away. Calculate the maximum power dissipation as follows:

$$P = (I_{\text{LIMIT}})^2 \times R_{\text{ON}}$$

where I_{LIMIT} is the preset current limit (1.0A max) and R_{ON} is the on-resistance of the switch (125m Ω max).

When the output is short-circuited, foldback-current limiting activates and the voltage drop across the switch equals the input supply. The power dissipated across the switch increases, as does the die temperature. If the fault condition is not removed, the thermal-overload-protection circuitry activates (see the *Thermal Shutdown* section). Wide power-bus planes connected to IN and OUT and a ground plane in contact with the device will help dissipate additional heat.

Chip Information

TRANSISTOR COUNT: 715

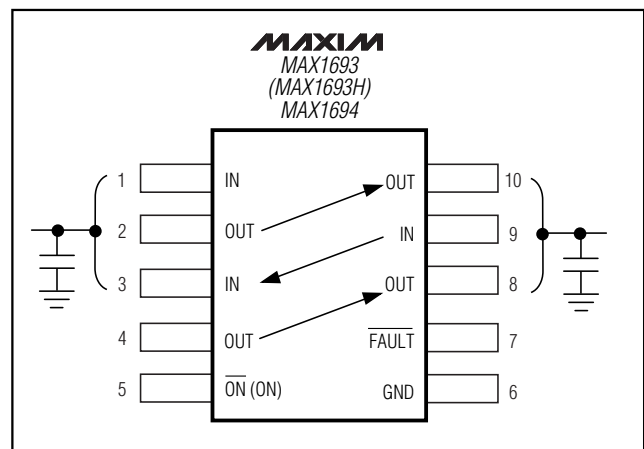

Figure 3. IN and OUT Cross Connections for a Single-Layer Board

USB Current-Limited Switches with Fault Blanking

Package Information

MAX1693/(MAX1693H)/MAX1694

10LUMAX.EPS

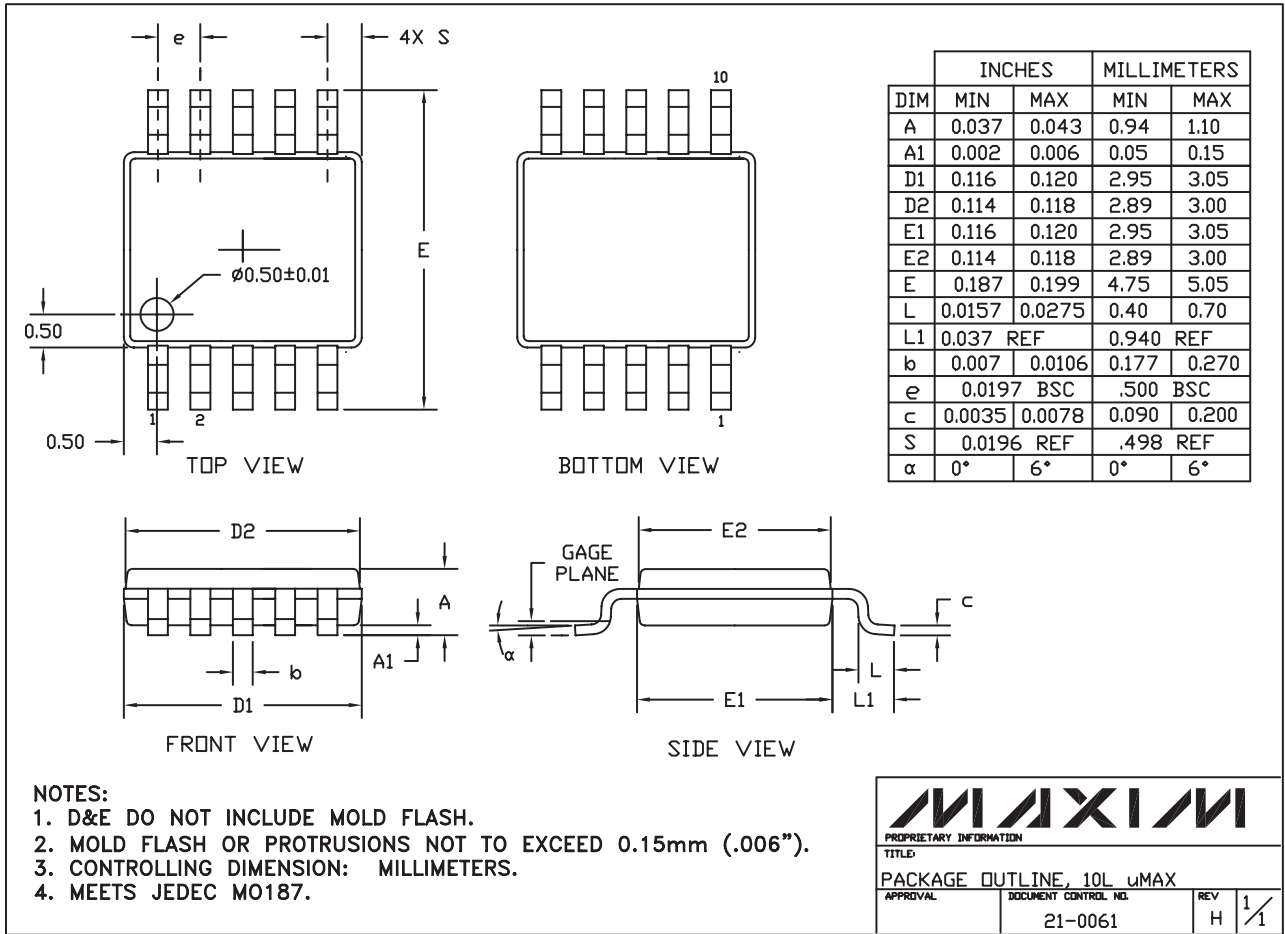

Note: Neither the MAX1693/(MAX1693H) nor MAX1694 has an exposed pad.

Maxim cannot assume responsibility for use of any circuitry other than circuitry entirely embodied in a Maxim product. No circuit patent licenses are implied. Maxim reserves the right to change the circuitry and specifications without notice at any time.

Maxim Integrated Products, 120 San Gabriel Drive, Sunnyvale, CA 94086 408-737-7600 _____ **9**