

MAX9617–MAX9620

Single/Dual SC70, Zero-Drift, High-Efficiency, 1.5MHz Op Amps with RRIO

General Description

The MAX9617–MAX9620 are low-power, zero-drift operational amplifiers available in space-saving SC70 packages. They are designed for use in portable consumer, medical, and industrial applications.

The MAX9617–MAX9620 feature rail-to-rail CMOS inputs and outputs, a 1.5MHz GBW at just 59µA supply current and 10µV (max) zero-drift input offset voltage over time and temperature. The zero-drift feature reduces the high 1/f noise typically found in CMOS input operational amplifiers, making it useful for a wide variety of low-frequency measurement applications.

The MAX9617 and MAX9619 are available in a space-saving, 2mm x 2mm, 6-pin SC70 package. The MAX9619 features a power-saving shutdown mode. The MAX9618 is available in a 2mm x 2mm, 8-pin SC70 package. The MAX9620 is available in a 2mm x 2mm, 5-pin SC70 package. All devices are specified over the -40°C to +125°C automotive operating temperature range.

Applications

Sensor Interfaces
 Loop-Powered Systems
 Portable Medical Devices
 Battery-Powered Devices
 Cardiac Monitors

Features

- ◆ Low 59µA Quiescent Current
- ◆ Very-Low 10µV (max) Input Offset Voltage
- ◆ Dual Version Available in an 8-Pin SC70 Package
- ◆ Low Input Noise
 $42\text{nV}/\sqrt{\text{Hz}}$ at 1kHz
 0.42µV_{p-p} from 0.1Hz to 10Hz
- ◆ Rail-to-Rail Inputs and Outputs
- ◆ 1.5MHz GBW
- ◆ Ultra-Low 10pA Input Bias Current
- ◆ Single 1.8V to 5.5V Supply Voltage Range
- ◆ Unity-Gain Stable
- ◆ Power-Saving Shutdown Mode (MAX9619)
- ◆ Available in Tiny 5-Pin SC70 (MAX9620), 6-Pin SC70 (MAX9617/MAX9619), and 8-Pin SC70 (MAX9618) Packages

Ordering Information

PART	TEMP RANGE	PIN-PACKAGE	TOP MARK
MAX9617AXT+	-40°C to +125°C	6 SC70	ADS
MAX9618AXA+	-40°C to +125°C	8 SC70	AAC
MAX9619AXT+	-40°C to +125°C	6 SC70	ADX
MAX9620AXK+	-40°C to +125°C	5 SC70	AUF

+Denotes a lead(Pb)-free/RoHS-compliant package.

Functional Diagrams

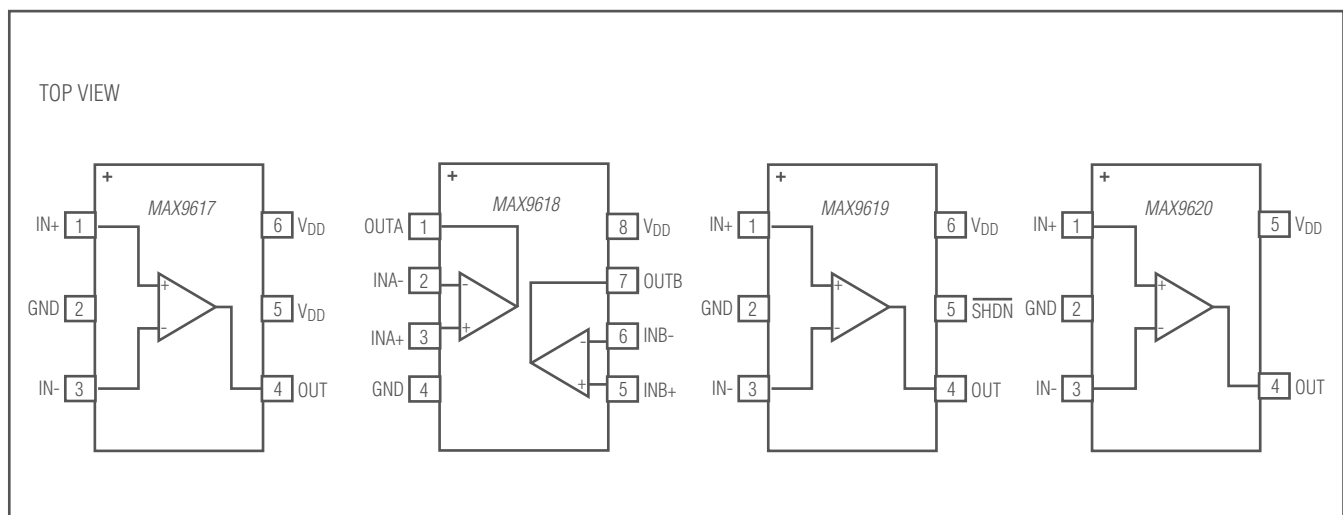

For pricing, delivery, and ordering information, please contact Maxim Direct at 1-888-629-4642, or visit Maxim's website at www.maximintegrated.com.

MAX9617-MAX9620

Single/Dual SC70, Zero-Drift, High-Efficiency, 1.5MHz Op Amps with RRIO

ABSOLUTE MAXIMUM RATINGS

IN+, IN-, $\overline{\text{SHDN}}$, (VDD to GND)	-0.3V to +6V	6-Pin SC70 (derate 3.1mW/°C above +70°C).....	245.4mW
OUT to GND	-0.3V to (VDD + 0.3V)	8-Pin SC70 (derate 3.1mW/°C above +70°C).....	245mW
Short-Circuit Duration to Either Supply Rail, OUT, OUTA, OUTB.....	10s	Operating Temperature Range	-40°C to +125°C
Continuous Input Current (any pins).....	±20mA	Junction Temperature	+150°C
Continuous Power Dissipation (TA = +70°C) 5-Pin SC70 (derate 3.1mW/°C above +70°C).....	247mW	Storage Temperature Range.....	-65°C to +150°C
		Lead Temperature (soldering, 10s)	+300°C
		Soldering Temperature (reflow)	+260°C

Stresses beyond those listed under "Absolute Maximum Ratings" may cause permanent damage to the device. These are stress ratings only, and functional operation of the device at these or any other conditions beyond those indicated in the operational sections of the specifications is not implied. Exposure to absolute maximum rating conditions for extended periods may affect device reliability.

ELECTRICAL CHARACTERISTICS

(VDD = +3.3V, V_{GND} = 0V, V_{IN+} = V_{IN-} = V_{DD}/2, R_L = 100kΩ to V_{DD}/2, TA = -40°C to +125°C, unless otherwise noted. Typical values are at +25°C.) (Note 1)

PARAMETER	SYMBOL	CONDITIONS	MIN	TYP	MAX	UNITS
POWER SUPPLY						
Supply Voltage Range	VDD	Guaranteed by PSRR, 0°C ≤ TA ≤ +70°C	1.6		5.5	V
		Guaranteed by PSRR, -40°C ≤ TA ≤ +125°C	1.8		5.5	
Supply Current (per Amplifier)	IDD	TA = +25°C		59	78	μA
		-40°C ≤ TA ≤ +125°C			111	
Power-Supply Rejection Ratio (Note 2)	PSRR	VDD = 1.8V to 5.5V	TA = +25°C	119	135	dB
			-40°C ≤ TA ≤ +125°C	107		
		0°C ≤ TA ≤ +70°C, VDD = 1.6V to 5.5V		116	135	
Power-Up Time	tON	VDD = 0V to 3V step, Av = 1V/V		20		μs
Shutdown Supply Current	I $\overline{\text{SHDN}}$	MAX9619 only			300	nA
Turn-On Time from Shutdown (MAX9619)	tOSD	VDD = 3.3V, V $\overline{\text{SHDN}}$ = 0V to 3.3V step		50		μs
DC SPECIFICATIONS						
Input Offset Voltage (Note 2)	VOS	TA = +25°C		0.8	10	μV
		-40°C ≤ TA ≤ +125°C			25	
Input Offset Voltage Drift (Note 2)	ΔVOS			5	120	nV/°C
Input Bias Current (Note 2)	IB	TA = +25°C		31	80	pA
		-40°C ≤ TA ≤ +85°C			95	
		-40°C ≤ TA ≤ +125°C			580	
Input Offset Current	I _{OS}			5		pA
Input Common-Mode Range	V _{CM}	Guaranteed by CMRR test	TA = +25°C	-0.1	VDD + 0.1	V
			-40°C ≤ TA ≤ +125°C	-0.1	VDD + 0.05	
Common-Mode Rejection Ratio (Note 2)	CMRR	-0.1V ≤ V _{CM} ≤ VDD + 0.1V, TA = +25°C		122	135	dB
		-0.1V ≤ V _{CM} ≤ VDD + 0.05V, -40°C ≤ TA ≤ +125°C		116		
Open-Loop Gain (Note 2)	AV _{OL}	20mV ≤ V _{OUT} ≤ VDD - 20mV, RL = 100kΩ to VDD/2		120	138	dB
		150mV ≤ V _{OUT} ≤ VDD - 150mV, RL = 5kΩ to VDD/2		123	160	

MAX9617-MAX9620

Single/Dual SC70, Zero-Drift, High-Efficiency, 1.5MHz Op Amps with RRIO

ELECTRICAL CHARACTERISTICS (continued)

($V_{DD} = +3.3V$, $V_{GND} = 0V$, $V_{IN+} = V_{IN-} = V_{DD}/2$, $R_L = 100k\Omega$ to $V_{DD}/2$, $T_A = -40^\circ C$ to $+125^\circ C$, unless otherwise noted. Typical values are at $+25^\circ C$.) (Note 1)

PARAMETER	SYMBOL	CONDITIONS		MIN	TYP	MAX	UNITS
Input Resistance	R_{IN}	Differential			50		$M\Omega$
		Common mode			200		
Output-Voltage Swing	V_{OH}	$V_{DD} - V_{OUT}$	$R_L = 100k\Omega$ to $V_{DD}/2$			12	mV
			$R_L = 5k\Omega$ to $V_{DD}/2$			22	
			$R_L = 600\Omega$ to $V_{DD}/2$		50		
	V_{OL}	V_{OUT}	$R_L = 100k\Omega$ to $V_{DD}/2$			11	
			$R_L = 5k\Omega$ to $V_{DD}/2$			18	
			$R_L = 600\Omega$ to $V_{DD}/2$		50		
Short-Circuit Current	I_{SC}				150		mA
AC SPECIFICATIONS							
Gain-Bandwidth Product	GBWP				1.5		MHz
Slew Rate	SR	$0V \leq V_{OUT} \leq 2V$			0.7		V/ μs
Input Voltage-Noise Density	e_n	$f = 1kHz$			42		nV/\sqrt{Hz}
Input Voltage Noise		$0.1Hz \leq f \leq 10Hz$			0.42		μV_{P-P}
Input Current-Noise Density	i_n	$f = 1kHz$			100		fA/\sqrt{Hz}
Phase Margin		$C_L = 20pF$			60		Degrees
Capacitive Loading	C_L	No sustained oscillation, $A_V = 1V/V$			400		pF
Crosstalk		$f = 10kHz$ (MAX9618)			-100		dB
LOGIC INPUT (MAX9619)							
Shutdown Input Low	V_{IL}					0.5	V
Shutdown Input High	V_{IH}			1.3			V
Shutdown Input Leakage Current	I_{IL}/I_{IH}				1	100	nA

Note 1: Specifications are 100% tested at $T_A = +25^\circ C$ (exceptions noted). All temperature limits are guaranteed by design.

Note 2: Guaranteed by design.

Typical Operating Characteristics

($V_{DD} = +3.3V$, $V_{GND} = 0V$, outputs have $R_L = 100k\Omega$ connected to $V_{DD}/2$. $T_A = +25^\circ C$, unless otherwise specified.)

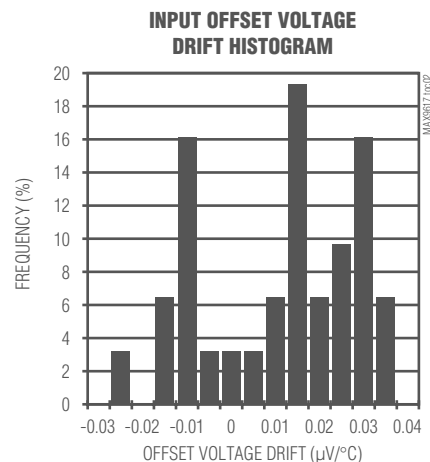
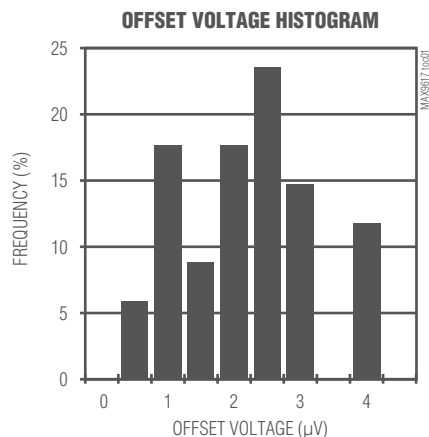

MAX9617-MAX9620

Single/Dual SC70, Zero-Drift, High-Efficiency, 1.5MHz Op Amps with RRIO

Typical Operating Characteristics (continued)

($V_{DD} = +3.3V$, $V_{GND} = 0V$, outputs have $R_L = 100k\Omega$ connected to $V_{DD}/2$. $T_A = +25^\circ C$, unless otherwise specified.)

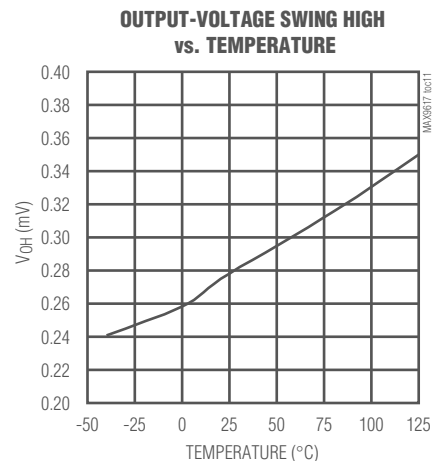
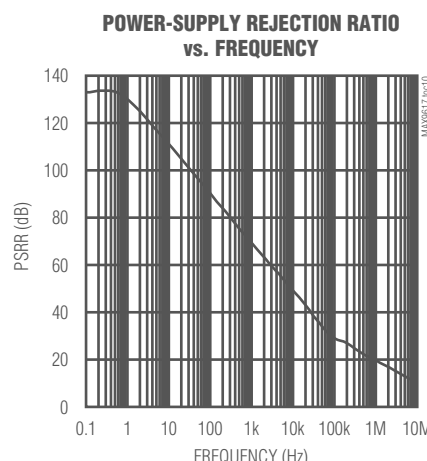
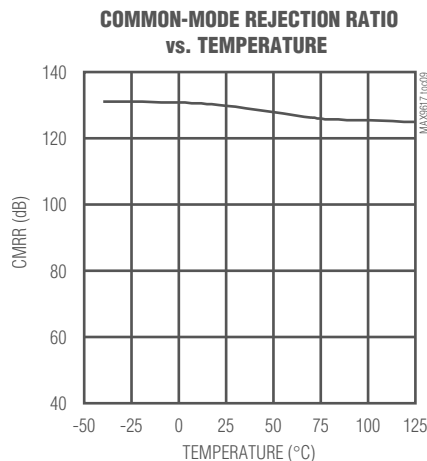
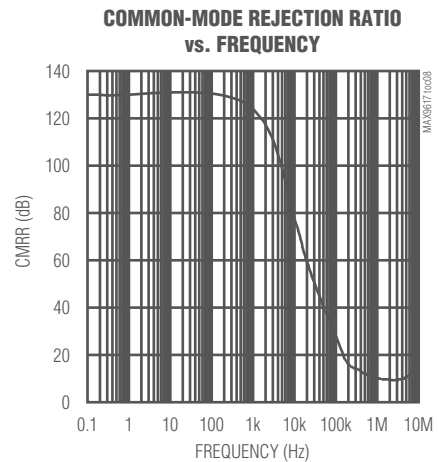
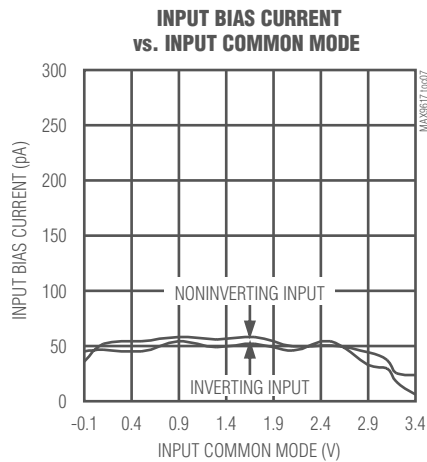
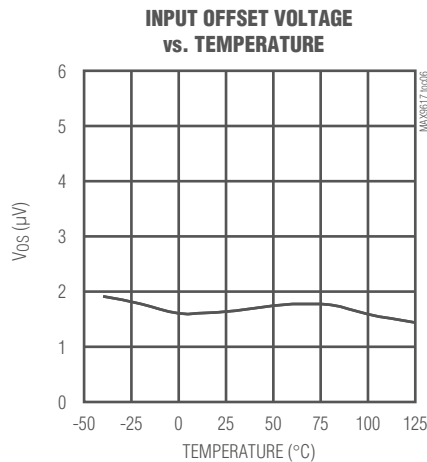
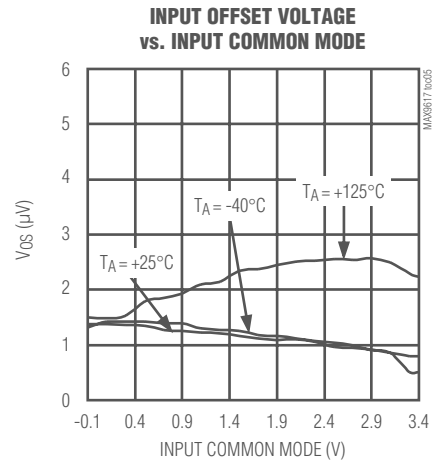
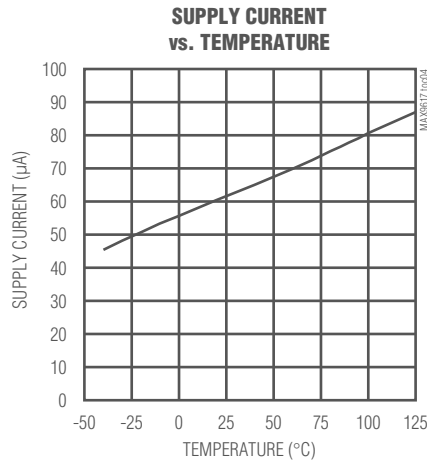
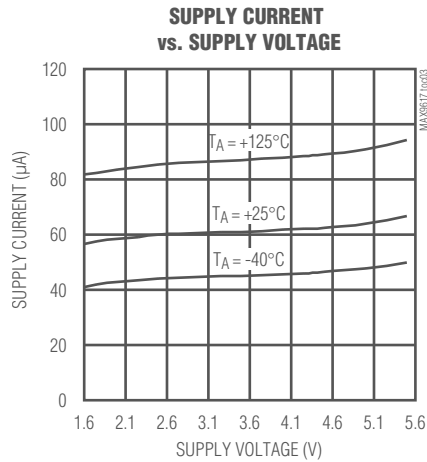

MAX9617-MAX9620

Single/Dual SC70, Zero-Drift, High-Efficiency, 1.5MHz Op Amps with RRIO

Typical Operating Characteristics (continued)

($V_{DD} = +3.3V$, $V_{GND} = 0V$, outputs have $R_L = 100k\Omega$ connected to $V_{DD}/2$. $T_A = +25^\circ C$, unless otherwise specified.)

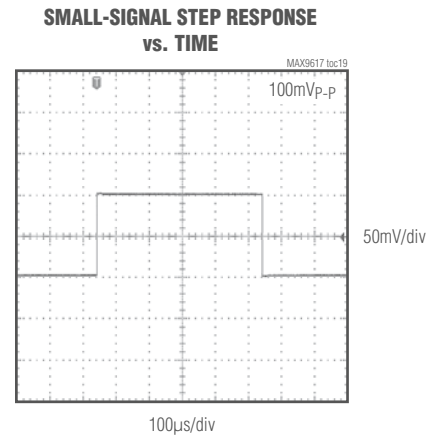
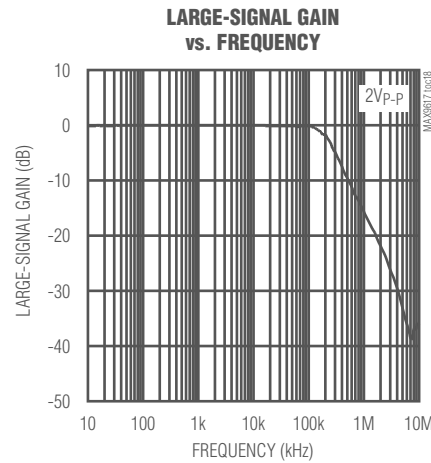
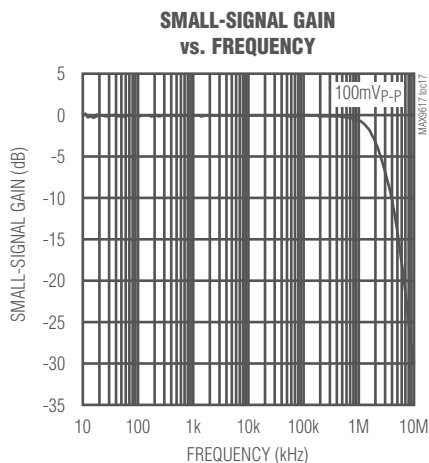
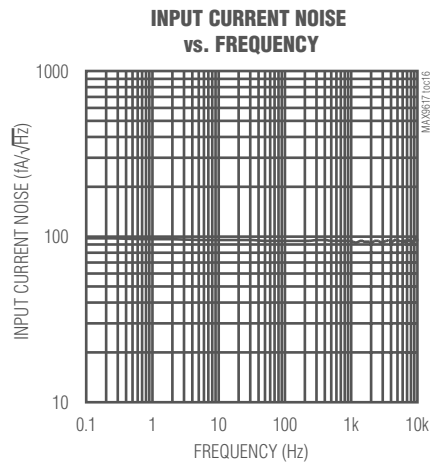
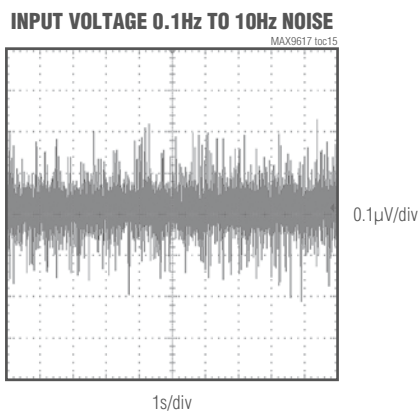
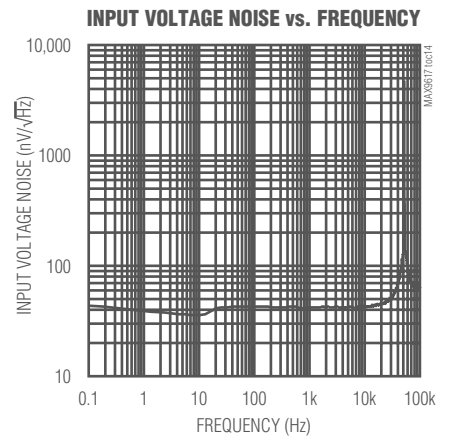
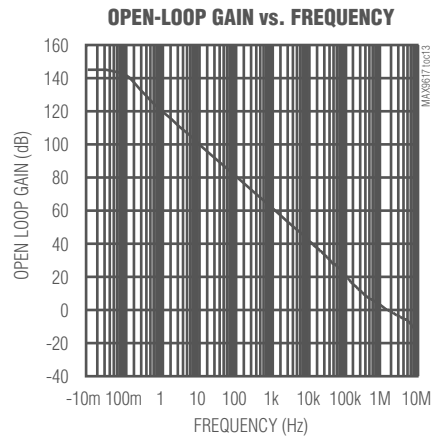
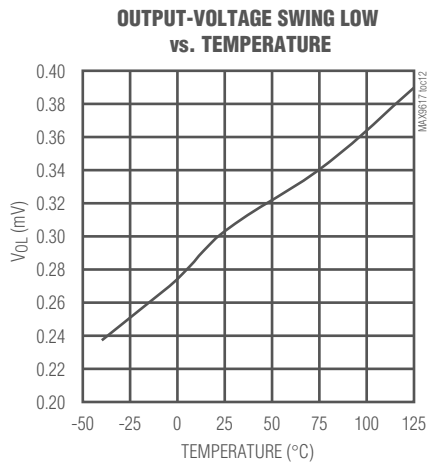

MAX9617–MAX9620

Single/Dual SC70, Zero-Drift, High-Efficiency, 1.5MHz Op Amps with RRIO

Typical Operating Characteristics (continued)

($V_{DD} = +3.3V$, $V_{GND} = 0V$, outputs have $R_L = 100k\Omega$ connected to $V_{DD}/2$. $T_A = +25^\circ C$, unless otherwise specified.)

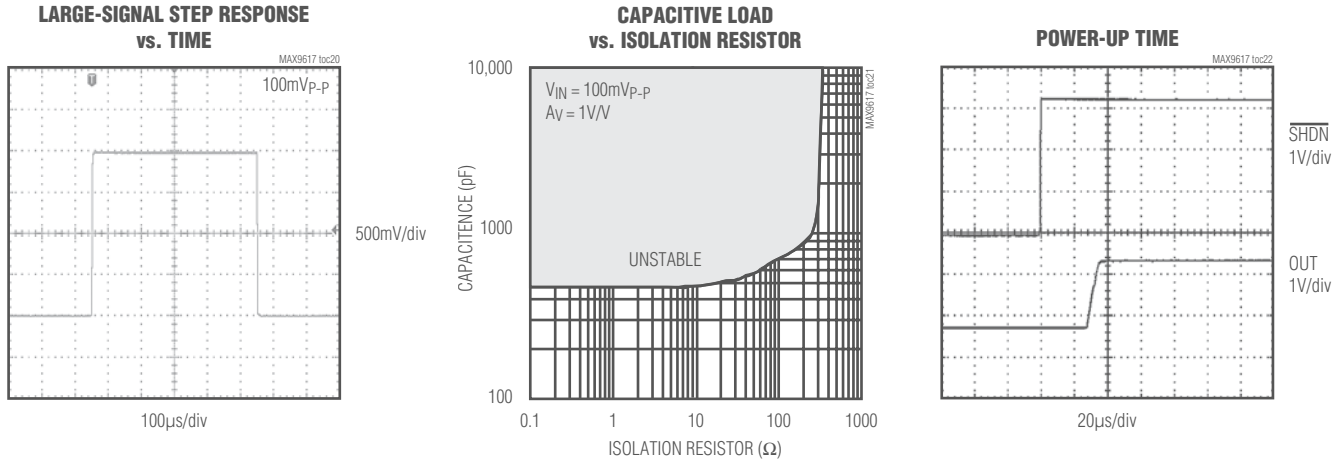

Pin Configurations

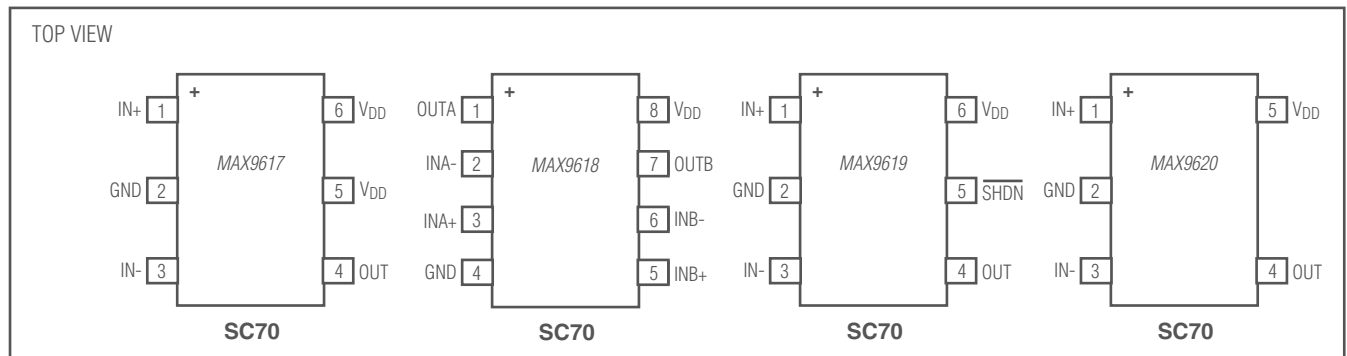

Pin Description

PIN				NAME	FUNCTION
MAX9617	MAX9618	MAX9619	MAX9620		
1	—	1	1	IN+	Positive Input
2	4	2	2	GND	Ground
3	—	3	3	IN-	Negative Input
4	—	4	4	OUT	Output
5, 6	8	6	5	V_{DD}	Positive Supply Voltage. Bypass to GND with a 0.1µF capacitor.
—	—	5	—	\overline{SHDN}	Shutdown. Pull shutdown low to activate shutdown mode.
—	1	—	—	OUTA	Channel A Output
—	2	—	—	INA-	Channel A Negative Input
—	3	—	—	INA+	Channel A Positive Input
—	5	—	—	INB+	Channel B Positive Input
—	6	—	—	INB-	Channel B Negative Input
—	7	—	—	OUTB	Channel B Output

MAX9617–MAX9620

Single/Dual SC70, Zero-Drift, High-Efficiency, 1.5MHz Op Amps with RRIO

Detailed Description

The MAX9617–MAX9620 are precision, low-power op amps ideal for signal processing applications. The MAX9617, MAX9619, and MAX9620 are single-channel devices. The MAX9618 is a dual-channel device. These devices use an innovative autozero technique that allows precision and low noise with a minimum amount of power. The low input offset voltage, CMOS inputs, and the absence of 1/f noise allows for optimization of active filter designs.

The MAX9617–MAX9620 achieve rail-to-rail performance at the input through the use of a low-noise charge pump. This ensures a glitch-free, common-mode input voltage range extending from the negative supply rail up to the positive supply rail, eliminating crossover distortion common to traditional n-channel/p-channel CMOS pair inputs, reducing harmonic distortion at the output.

The MAX9619 features a shutdown mode that greatly reduces quiescent current when the device is not operational.

Autozero

The MAX9617–MAX9620 feature an autozero circuit that allows the device to achieve less than 10 μ V (max) of input offset voltage and eliminates the 1/f noise.

Internal Charge Pump

An internal charge pump provides an internal supply typically 1V beyond the upper rail. This internal rail allows the MAX9617–MAX9620 to achieve true rail-to-rail inputs and outputs, while providing excellent common-mode rejection, power-supply rejection ratios, and gain linearity.

The charge pump requires no external components, and in most applications is entirely transparent to the user. The operating frequency is well beyond the unity-gain

frequency of the amplifier, avoiding aliasing or other signal integrity issues in sensitive applications.

Shutdown Operation

The MAX9619 features an active-low shutdown mode that lowers the quiescent current to less than 300nA. In shutdown mode, the inputs and output are high impedance. This allows multiple devices to be multiplexed onto a single line without the use of external buffers. Pull $\overline{\text{SHDN}}$ high for normal operation.

The shutdown high (V_{IH}) and low (V_{IL}) threshold voltages are designed for ease of integration with digital controls like microcontroller outputs. These thresholds are independent of supply, eliminating the need for external pulldown circuitry.

Applications Information

The MAX9617–MAX9620 low-power, low-noise, and precision operational amplifiers are designed for applications in the portable medical, such as ECG and pulse oximetry, portable consumer, and industrial markets.

The MAX9617–MAX9620 are also ideal for loop-powered systems that interface with pressure sensors or strain gauges.

Capacitive-Load Stability

Driving large capacitive loads can cause instability in many op amps. The MAX9617–MAX9620 are stable with capacitive loads up to 400pF. Stability with higher capacitive loads can be improved by adding an isolation resistor in series with the op-amp output. This resistor improves the circuit's phase margin by isolating the load capacitor from the amplifier's output. The graph in the *Typical Operating Characteristics* gives the stable operation region for capacitive load versus isolation resistors.

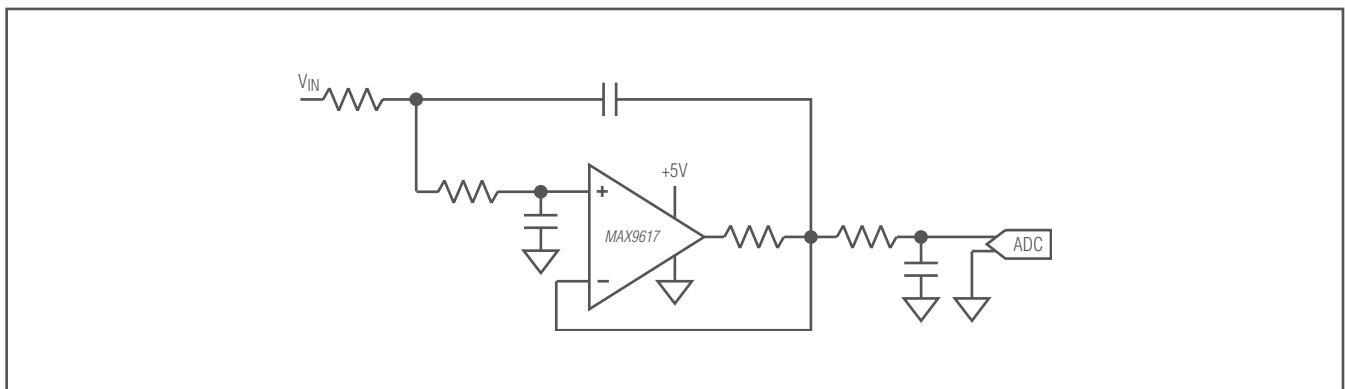

Figure 1. Typical Application Circuit: Sallen-Key Active Lowpass Filter

MAX9617–MAX9620

Single/Dual SC70, Zero-Drift, High-Efficiency, 1.5MHz Op Amps with RRIO

Power Supplies and Layout

The MAX9617–MAX9620 operate either with a single supply from +1.6V to +5.5V with respect to ground or with dual supplies from $\pm 0.8V$ to $\pm 2.75V$. When used with dual supplies, bypass both supplies with their own 0.1 μF capacitor to ground. When used with a single supply, bypass V_{DD} with a 0.1 μF capacitor to ground.

Careful layout technique helps optimize performance by decreasing the amount of stray capacitance at the op amp's inputs and outputs. To decrease stray capacitance, minimize trace lengths by placing external components close to the op amp's pins.

Chip Information

PROCESS: BiCMOS

Package Information

For the latest package outline information and land patterns (footprints), go to www.maximintegrated.com/packages. Note that a "+", "#", or "-" in the package code indicates RoHS status only. Package drawings may show a different suffix character, but the drawing pertains to the package regardless of RoHS status.

PACKAGE TYPE	PACKAGE CODE	OUTLINE NO.	LAND PATTERN NO.
5 SC70	X5+1	21-0076	90-0188
6 SC70	X6SN+1	21-0077	90-0189
8 SC70	X8C+1	21-0460	90-0348

MAX9617–MAX9620

Single/Dual SC70, Zero-Drift, High-Efficiency, 1.5MHz Op Amps with RRIO

Revision History

REVISION NUMBER	REVISION DATE	DESCRIPTION	PAGES CHANGED
0	7/09	Initial release	—
1	9/09	Removed references to MAX9617 shutdown functionality	1, 2, 3, 6, 7
2	2/10	Removed future product reference for the MAX9618, and added MAX9619 and MAX9620 to the data sheet	1–11
3	6/10	Corrected <i>General Description</i> to show that only the MAX9619 has shutdown, corrected the MAX9617 Pin Configuration, and added soldering temperature	1, 2, 12
4	2/11	Updated bias current specifications	2
5	7/11	Updated input and shutdown specs in the <i>Absolute Maximum Ratings</i>	2
6	8/12	Added top marks to <i>Ordering Information</i>	1



Maxim Integrated cannot assume responsibility for use of any circuitry other than circuitry entirely embodied in a Maxim Integrated product. No circuit patent licenses are implied. Maxim Integrated reserves the right to change the circuitry and specifications without notice at any time. The parametric values (min and max limits) shown in the Electrical Characteristics table are guaranteed. Other parametric values quoted in this data sheet are provided for guidance.

Maxim Integrated 160 Rio Robles, San Jose, CA 95134 USA 1-408-601-1000

9