

PLEASE CHECK WWW.MOLEX.COM FOR LATEST PART INFORMATION

Part Number: [0022057035](#)
Status: **Active**
Overview: SPOX™ Wire-to-Board Connectors
Description: 2.50mm Pitch SPOX™ Wire-to-Board Header, Right Angle, Shrouded, Friction Lock, 3 Circuits

Documents:

[3D Model](#) [Packaging Specification SPK-5268-001 \(PDF\)](#)
[Drawing \(PDF\)](#) [RoHS Certificate of Compliance \(PDF\)](#)
[Product Specification PS-5264-001 \(PDF\)](#)

Agency Certification

CSA LR19980
 UL E29179

General

Product Family PCB Headers
 Series 5268
 Application Signal, Wire-to-Board
 MolexKits Yes
 Overview SPOX™ Wire-to-Board Connectors
 Product Name SPOX™
 UPC 800753592766

Physical

Breakaway No
 Circuits (Loaded) 3
 Circuits (maximum) 3
 Color - Resin Natural
 Durability (mating cycles max) 30
 First Mate / Last Break No
 Flammability 94V-0
 Glow-Wire Compliant No
 Guide to Mating Part No
 Keying to Mating Part None
 Lock to Mating Part Yes
 Material - Plating Mating Tin
 Material - Plating Termination Tin
 Material - Resin Nylon
 Net Weight 344.400/mg
 Number of Rows 1
 Orientation Right Angle
 PC Tail Length 3.50mm
 PCB Locator No
 PCB Retention None
 PCB Thickness - Recommended 1.60mm
 Packaging Type Bag
 Pitch - Mating Interface 2.50mm
 Plating min - Mating 4.064µm
 Plating min - Termination 4.064µm
 Polarized to Mating Part Yes
 Polarized to PCB No
 Shrouded Fully
 Stackable No
 Surface Mount Compatible (SMC) No
 Temperature Range - Operating -40°C to +105°C
 Termination Interface: Style Through Hole

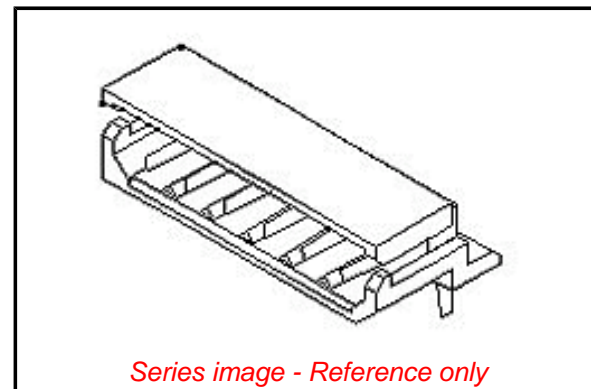

EU ELV

Not Relevant

EU RoHS

Compliant

REACH SVHC

Contains SVHC(2015
 June 15): No

Halogen-Free

Status

Not Low-Halogen

Need more information on product environmental compliance?

Email productcompliance@molex.com
 Please visit the [Contact Us](#) section for any non-product compliance questions.

China ROHS

ELV

Green Image

Not Relevant

Search Parts in this Series

[5268 Series](#)

Mates With

[5264 SPOX™ Wire-to-Board Crimp Housing](#)

Electrical

Current - Maximum per Contact 3.0A
Voltage - Maximum 250V

Material Info

Old Part Number 5268-03A

Reference - Drawing Numbers

Packaging Specification SPK-5268-001
Product Specification PS-5264-001, RPS-5264-005, RPS-5268-001
Sales Drawing SD-5268-NA

This document was generated on 10/20/2015

PLEASE CHECK WWW.MOLEX.COM FOR LATEST PART INFORMATION