

**PLEASE CHECK WWW.MOLEX.COM FOR LATEST PART INFORMATION**

**Part Number:** [0039532304](#)  
**Status:** **Active**  
**Description:** 1.25mm (.049") Pitch FFC/FPC Connector, Through-Hole, Right Angle, ZIF, Top Contact Style, 30 Circuits, Lead-free

**Documents:**

[3D Model](#) [Product Specification PS-5597-004 \(PDF\)](#)  
[Drawing \(PDF\)](#) [RoHS Certificate of Compliance \(PDF\)](#)

**General**

Product Family FFC/FPC Connectors  
 Series [5597](#)  
 Product Name N/A

**Physical**

Circuits (Loaded) 30  
 Color - Resin Natural  
 Contact Position Top  
 Durability (mating cycles max) 30  
 Entry Angle 90° Angle  
 Flammability 94V-0  
 Mated Height (in) 0.197 In  
 Mated Height (mm) 5.00 mm  
 Material - Metal Phosphor Bronze  
 Material - Plating Mating Tin-Bismuth  
 Material - Plating Termination Tin-Bismuth  
 Material - Resin Polyester  
 Number of Rows 1  
 Orientation Right Angle  
 PC Tail Length (in) 0.138 In  
 PC Tail Length (mm) 3.50 mm  
 PCB Locator No  
 PCB Retention None  
 Packaging Type Tray  
 Pitch - Mating Interface (in) 0.049 In  
 Pitch - Mating Interface (mm) 1.25 mm  
 Plating min: Mating (µin) 40  
 Plating min: Mating (µm) 1  
 Plating min: Termination (µin) 40  
 Plating min: Termination (µm) 1  
 Polarized to PCB No  
 Stackable No  
 Surface Mount Compatible (SMC) No  
 Temperature Range - Operating -20°C to +80°C  
 Termination Interface: Style Through Hole  
 Wire/Cable Type FFC/FPC

**Electrical**

Current - Maximum 1A  
 UL E29179  
 Voltage - Maximum 200V

**Material Info**

Old Part Number 5597-30APB7F

**Reference - Drawing Numbers**

Product Specification PS-5597-004  
 Product Specification RPS-5597-005

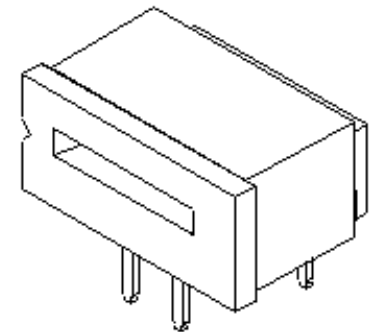

*Series image - Reference only*

**EU RoHS**

**ELV and RoHS  
 Compliant**  
**REACH SVHC  
 Contains SVHC: No**  
**Halogen-Free  
 Status  
 Not Reviewed**

**China RoHS**



**Need more information on product  
 environmental compliance?**

Email [productcompliance@molex.com](mailto:productcompliance@molex.com)  
 Please visit the [Contact Us](#) section for any  
 non-product compliance questions.

**Search Parts in this Series**

[5597 Series](#)

Product Specification  
Product Specification  
Product Specification  
Product Specification  
Product Specification  
Sales Drawing

RPS-5597-006  
RPS-5597-008  
RPS-5597-013  
RPS-5597-014  
RPS-5597-015  
SD-5597-011

This document was generated on 11/05/2009

**PLEASE CHECK [WWW.MOLEX.COM](http://WWW.MOLEX.COM) FOR LATEST PART INFORMATION**