

PLEASE CHECK WWW.MOLEX.COM FOR LATEST PART INFORMATION

Part Number: [0428192223](#)
Status: **Active**
Description: 10.00mm (.394") Pitch Mini-Fit Sr.™ Header, Single Row, Vertical, 2 Circuits, 2.36mm (.093") PCB Thickness, 0.76µm (30µ") Gold (Au) Selective Plating

Documents:

3D Model	Drawing (PDF)
Test Summary (PDF)	RoHS Certificate of Compliance (PDF)
Product Literature (PDF)	

General

Product Family	PCB Headers
Series	42819
Application	Wire-to-Board
Product Name	Mini-Fit Sr.™

Physical

Breakaway	No
Circuits (Loaded)	2
Circuits (maximum)	2
Color - Resin	Black
Durability (mating cycles max)	100
First Mate / Last Break	No
Flammability	94V-0
Glow-Wire Compliant	No
Guide to Mating Part	No
Keying to Mating Part	None
Lock to Mating Part	Yes
Material - Metal	Brass
Material - Plating Mating	Gold
Material - Plating Termination	Tin
Material - Resin	High Temperature Thermoplastic
Number of Rows	1
Orientation	Vertical
PC Tail Length (in)	0.201 In
PC Tail Length (mm)	5.10 mm
PCB Locator	Yes
PCB Retention	Yes
PCB Thickness Recommended (in)	0.093 In
PCB Thickness Recommended (mm)	2.40 mm
Packaging Type	Tray
Pitch - Mating Interface (in)	0.394 In
Pitch - Mating Interface (mm)	10.00 mm
Plating min: Mating (µin)	30
Plating min: Mating (µm)	0.76
Plating min: Termination (µin)	100
Plating min: Termination (µm)	2.50
Polarized to Mating Part	Yes
Polarized to PCB	Yes
Shrouded	Fully
Stackable	No
Surface Mount Compatible (SMC)	No
Temperature Range - Operating	-40°C to +105°C
Termination Interface: Style	Through Hole

Electrical

CSA	LR19980
-----	---------

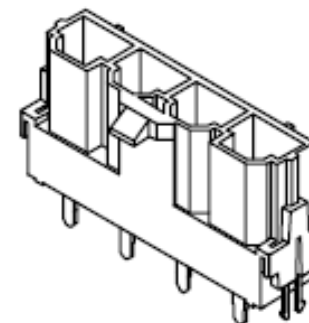

Series image - Reference only

EU RoHS

ELV and RoHS Compliant
REACH SVHC
 Not Reviewed
Halogen-Free
Status
Not Reviewed

China RoHS



Need more information on product environmental compliance?

Email productcompliance@molex.com
 Please visit the [Contact Us](#) section for any non-product compliance questions.

Search Parts in this Series

42819 Series

Mates With

42816 Receptacle with TPA

Current - Maximum	48A
TUV	R72081037
UL	E29179
Voltage - Maximum	600V

Solder Process Data

Duration at Max. Process Temperature (seconds)	3
Lead-free Process Capability	Wave Capable (TH only)
Max. Cycles at Max. Process Temperature	1
Process Temperature max. C	265

Material Info**Reference - Drawing Numbers**

Product Specification	RPS-42815-011
Product Specification	RPS-42815-012
Product Specification	RPS-42815-013
Product Specification	RPS-42815-014
Sales Drawing	SDA-42819-0002

This document was generated on 11/05/2009

PLEASE CHECK WWW.MOLEX.COM FOR LATEST PART INFORMATION