

[Molex.com](#)

English  
日本語  
한국어  
简体中文

[Register | Login](#)  
[My Parts \( 0 items \)](#)

Search site: Search:  [Go](#)

- Product Name**
- Cross-Ref**
- Catalog**
- Literature**
- Industries**
- Standards**
- Contact Us**
- About Us**
- Investors**
- Careers**

- [Connectors](#)
- [Sockets](#)
- [I/O Connectors](#)
- [Cable Assemblies](#)
- [Fiber Optics](#)
- [Printed Circuit Products](#)
- [Industrial Products](#)
- [Lighting Products](#)

**Switch Language**

- [Home](#)
- [PCB Headers](#)
- [Datasheet](#)

**Need Assistance?**

- [Contact Us](#)
- [Find a Distributor](#)
- [Order Samples](#)
- [Tech Library](#)
- [Ecocare](#)
- [Electrical Models](#)

[Printer-friendly page](#)

[Email this page](#)

**Part Number:**  
**0430451618**

**Status:**  
**Active**

**Overview:**  
**Micro-Fit, 3.0™**

**Description:**  
3.00mm (.118") Pitch Micro-Fit 3.0™ Header, Surface Mount, Dual Row, Vertical, with Solder Tab, 16 Circuits, Tin (Sn) Plating, Glow Wire Compatible

**Documents:** *Note - Please disable browser pop-up blockers for documents on www.molex.com*  
[Drawing \(PDF\)](#) [Product Specification PS-43045 \(PDF\)](#)

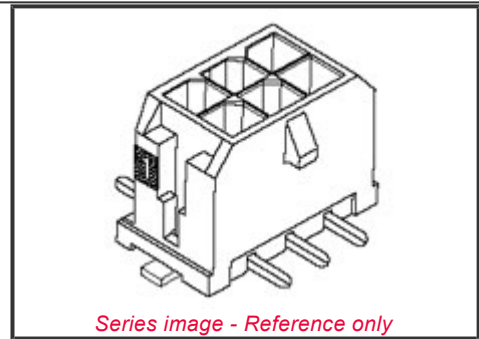

**EU RoHS**  
**ELV and RoHS**  
**Compliant**

**REACH SVHC**  
**Contains SVHC: No**

**Halogen-Free**  
**Status**  
**Halogen-Free**

**China RoHS**



**Need more information on product environmental compliance?**Email [productcompliance@molex.com](mailto:productcompliance@molex.com)For a multiple part number RoHS Certificate of Compliance, [click here](#)Please visit the [Contact Us](#) section for any non-product compliance questions.**Search Parts in this Series**[43045Series](#)**Mates With**[43025](#)[Product Literature \(PDF\)](#)**Order Products:****Part Detail:** ([show all](#))[General](#)[Physical](#)[Electrical](#)[Agency Certification](#)[Solder Process](#)[Data](#)[Material Info](#)[Reference](#) - [Drawing Numbers](#)**General**

Product Family	PCB Headers
Series	<a href="#">43045</a>
Application	Wire-to-Board
Comments	Glow Wire Equivalent Part Number <a href="#">430451618</a> High Temperature, Square Pin, Solder Type
Overview	<a href="#">Micro-Fit 3.0™</a>
Product Literature Order No	USA-106
Product Name	Micro-Fit 3.0™

**Physical**

Breakaway	No
Circuits (Loaded)	16
Circuits (maximum)	16
Color - Resin	Black
Durability (mating cycles max)	30
Flammability	94V-0
Glow-Wire Compliant	Yes
Mated Height (in)	0.680 In
Mated Height (mm)	17.27 mm
Material - Metal	Brass
Material - Plating Mating	Tin
Material - Plating Termination	Tin
Material - Resin	High Temperature Thermoplastic
Number of Rows	2
Orientation	Vertical
PCB Locator	Yes
PCB Retention	Yes
PCB Thickness Recommended (in)	0.062 In
PCB Thickness Recommended (mm)	1.60 mm
Packaging Type	Embossed Tape on Reel
Pitch - Mating Interface (in)	0.118 In
Pitch - Mating Interface (mm)	3.00 mm
Plating min: Mating (µin)	35
Plating min: Mating (µm)	0.88
Plating min: Termination (µin)	35
Plating min: Termination (µm)	0.88
Polarized to PCB	Yes
Shrouded	Fully
Stackable	No
Surface Mount Compatible (SMC)	N/A
Temperature Range - Operating	-40°C to +105°C
Termination Interface: Style	Surface Mount

**Electrical**(Please review the Product Specification for specific details.)

Current - Maximum per Contact	5A
Voltage - Maximum	250V

**Agency Certification**

CSA	LR19980
TUV	R72081037
UL	E29179

**Solder Process Data**

Duration at Max. Process Temperature (seconds)	30
Lead-free Process Capability	Reflow Capable (SMT only)
Max. Cycles at Max. Process Temperature	3
Process Temperature max. C	260

**Material Info**

**Reference - Drawing Numbers**

Product Specification	PS-43045, RPS-43045-003, RPS-43045-004
Sales Drawing	SD-43045-007