

PLEASE CHECK WWW.MOLEX.COM FOR LATEST PART INFORMATION

Part Number: [0510150500](#)
Status: **Active**
Description: 2.00mm (.079") Pitch Board-In Crimp Housing, Low Profile, 5 Circuits

Documents:

3D Model	Product Specification PS-51015-002 (PDF)
Drawing (PDF)	RoHS Certificate of Compliance (PDF)
Product Specification PS-51015-001 (PDF)	

General

Product Family	Crimp Housings
Series	51015
Product Name	Board-In

Physical

Circuits (maximum)	5
Color - Resin	Natural
Flammability	94V-0
Gender	Male
Glow-Wire Compliant	No
Material - Resin	Nylon
Number of Rows	1
Packaging Type	Bag
Panel Mount	No
Pitch - Mating Interface (in)	0.079 In
Pitch - Mating Interface (mm)	2.00 mm
Stackable	No
Temperature Range - Operating	-40°C to +105°C

Electrical

UL	E29179
----	--------

Material Info

Reference - Drawing Numbers

Product Specification	PS-51015-001
Product Specification	PS-51015-002
Product Specification	RPS-51015-001
Product Specification	RPS-51015-003
Product Specification	RPS-51015-004
Product Specification	RPS-51015-006
Sales Drawing	SD-51015-**00

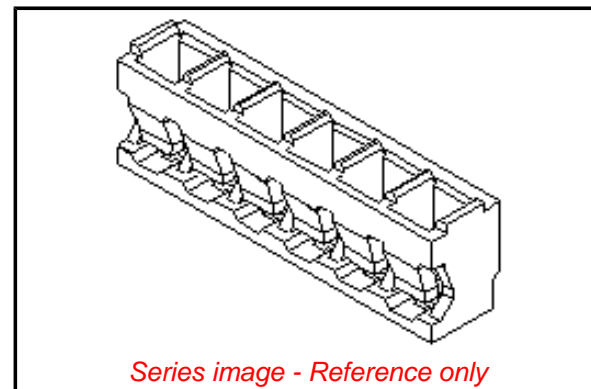

EU RoHS

**ELV and RoHS
Compliant**
**REACH SVHC
Contains SVHC: No
Halogen-Free
Status**

China RoHS



**Need more information on product
environmental compliance?**

Email productcompliance@molex.com
Please visit the [Contact Us](#) section for any
non-product compliance questions.

Search Parts in this Series
[51015 Series](#)

Use With
[50034](#)