

PLEASE CHECK WWW.MOLEX.COM FOR LATEST PART INFORMATION

Part Number: [53408-0679](#)
Status: **Active**
Description: 1.00mm Pitch Plug, Surface Mount, Dual Row, Vertical Stacking, Mated Stack Height 18.00mm and 20.00mm, Lead-Free, 60 Circuits

Documents:

[3D Model](#) [Packaging Specification SPK-53408-001 \(PDF\)](#)
[Drawing \(PDF\)](#) [RoHS Certificate of Compliance \(PDF\)](#)
[Product Specification PS-52584-003 \(PDF\)](#)

General

Product Family	PCB Headers
Series	53408
Application	Board-to-Board, Signal
Product Name	N/A
UPC	822348189878

Physical

Breakaway	No
Circuits (Loaded)	60
Circuits (maximum)	60
Color - Resin	Natural
Durability (mating cycles max)	50
First Mate / Last Break	No
Glow-Wire Compliant	No
Guide to Mating Part	No
Keying to Mating Part	None
Lock to Mating Part	None
Mated Height	18.00mm, 20.00mm
Material - Metal	Phosphor Bronze
Material - Plating Mating	Gold
Material - Plating Termination	Tin
Material - Resin	High Temperature Thermoplastic
Net Weight	3451.700/mg
Number of Rows	2
Orientation	Vertical
PCB Locator	Yes
PCB Retention	Yes
PCB Thickness - Recommended	1.00mm
Packaging Type	Tube
Pitch - Mating Interface	1.00mm
Plating min - Mating	0.254µm
Plating min - Termination	1.016µm
Polarized to PCB	No
Shrouded	Fully
Stackable	No
Temperature Range - Operating	-55°C to +85°C
Termination Interface: Style	Surface Mount

Electrical

Current - Maximum per Contact	0.5A
Voltage - Maximum	100V

Material Info

Reference - Drawing Numbers

Packaging Specification	SPK-53408-001
-------------------------	---------------

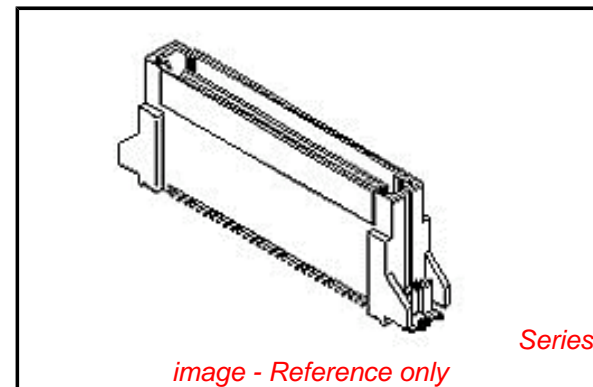

image - Reference only

EU RoHS

**ELV and RoHS
Compliant**

REACH SVHC

**Contains SVHC: No
Low-Halogen Status
Low-Halogen**

China RoHS



**Need more information on product
environmental compliance?**

Email productcompliance@molex.com
 For a multiple part number RoHS Certificate of Compliance, [click here](#)

Please visit the [Contact Us](#) section for any non-product compliance questions.

Search Parts in this Series

[53408Series](#)

Mates With

PCB Receptacle [52584](#) , [52602](#)

This document was generated on 06/06/2013

PLEASE CHECK WWW.MOLEX.COM FOR LATEST PART INFORMATION