

PLEASE CHECK WWW.MOLEX.COM FOR LATEST PART INFORMATION

Part Number: [0906351102](#)
Status: **Active**
Description: 1.27mm (.050") Pitch QF-50™, Single Beam, Vertical MIL/DIN Version, 0.76µm (30µ") Gold (Au), 10 Circuits

Documents:

[3D Model](#) [Product Specification PS-99020-0015 \(PDF\)](#)
[Drawing \(PDF\)](#) [RoHS Certificate of Compliance \(PDF\)](#)

General

Product Family Ribbon Cable / Wire Trap Connectors
 Series [90635](#)
 Comments Preloaded Upper Housing
 Component Type Housing
 Glow-Wire Compliant No
 Product Name QF-50™

Physical

Circuits (Loaded) 10
 Color - Resin Black
 Durability (mating cycles max) 300
 Entry Angle 90° Angle
 Flammability 94V-0
 Lock to Mating Part None
 Material - Metal Phosphor Bronze
 Material - Plating Mating Gold
 Material - Plating Termination Tin
 Material - Resin Polyester
 Number of Rows 2
 PCB Retention None
 Packaging Type Tray
 Pitch - Mating Interface (in) 0.050 In
 Pitch - Mating Interface (mm) 1.27 mm
 Plating min: Mating (µin) 30.4
 Plating min: Mating (µm) 0.76
 Plating min: Termination (µin) 40
 Plating min: Termination (µm) 1
 Polarized to Mating Part Yes
 Stackable No
 Surface Mount Compatible (SMC) N/A
 Temperature Range - Operating -25°C to +85°C
 Termination Interface: Style IDT or Pierce
 Wire Insulation Diameter 1.14mm (.045") max.
 Wire Size AWG 26
 Wire Size AWG 28
 Wire/Cable Type Ribbon Cable

Electrical

CSA LR19980
 Current - Maximum 1A
 UL E29179
 Voltage - Maximum 250V

Material Info

Reference - Drawing Numbers

Product Specification PS-99020-0015
 Sales Drawing SDA-90635

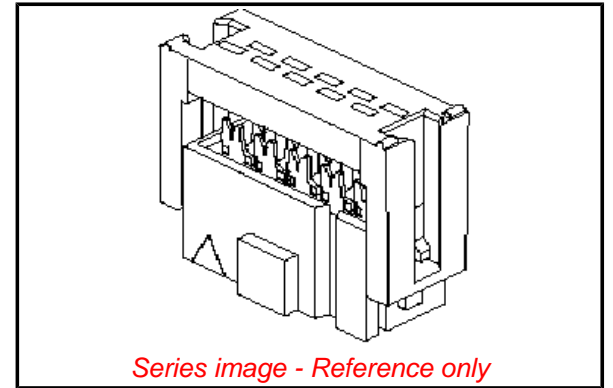

EU RoHS

ELV and RoHS Compliant
REACH SVHC Contains SVHC: No
Halogen-Free Status

China RoHS



Need more information on product environmental compliance?

Email productcompliance@molex.com
 Please visit the [Contact Us](#) section for any non-product compliance questions.

Search Parts in this Series

[90635 Series](#)

Mates With

[90663](#)

Use With

[90170](#)

Application Tooling | FAQ

Tooling specifications and manuals are found by selecting the products below. Crimp Height Specifications are then contained in the Application Tooling Specification document.

Global

Description	Product #
Changehead for Parallel Action Handtool 69008-0949, for QF-50™ and MX-50™ Connectors	0690080250
Semi-Automatic Bench Press PB15 C/W Cable	0691271150

Sensor for 90635
Connectors
Arbor Press Fixture 0690200680

This document was generated on 12/11/2009

PLEASE CHECK WWW.MOLEX.COM FOR LATEST PART INFORMATION