

PLEASE CHECK WWW.MOLEX.COM FOR LATEST PART INFORMATION

Part Number: [5018762840](#)
Status: **Active**
Overview: iGrid™ Wire-to-Board Dual-Row System
Description: 2.00mm Pitch iGrid™ Wire-to-Board Header, Dual Row, Right Angle, 28 Circuits

Documents:

[3D Model](#) [Packaging Specification SPK-501876-001 \(PDF\)](#)
[Drawing \(PDF\)](#) [RoHS Certificate of Compliance \(PDF\)](#)
[Product Specification PS-501646-001 \(PDF\)](#)

Agency Certification

UL E29179

General

Product Family PCB Headers
 Series 501876
 Application Signal, Wire-to-Board
 MolexKits Yes
 Overview iGrid™ Wire-to-Board Dual-Row System
 Product Name iGrid™
 UPC 822350171052

Physical

Breakaway No
 Circuits (Loaded) 28
 Circuits (maximum) 28
 Color - Resin Natural
 Durability (mating cycles max) 30
 Flammability 94V-0
 Glow-Wire Compliant No
 Keying to Mating Part Yes
 Lock to Mating Part Yes
 Material - Metal Brass
 Material - Plating Mating Tin
 Material - Plating Termination Tin
 Material - Resin Nylon
 Net Weight 3089.000/mg
 Number of Rows 2
 Orientation Right Angle
 PC Tail Length 3.20mm
 PCB Locator No
 PCB Retention None
 PCB Thickness - Recommended 1.20mm, 1.60mm
 Packaging Type Tray
 Pitch - Mating Interface 2.00mm
 Polarized to Mating Part Yes
 Polarized to PCB No
 Stackable No
 Surface Mount Compatible (SMC) No
 Temperature Range - Operating -40°C to +105°C
 Termination Interface: Style Through Hole

Electrical

Current - Maximum per Contact 2.0A
 Voltage - Maximum 250V AC (RMS)/DC

Material Info

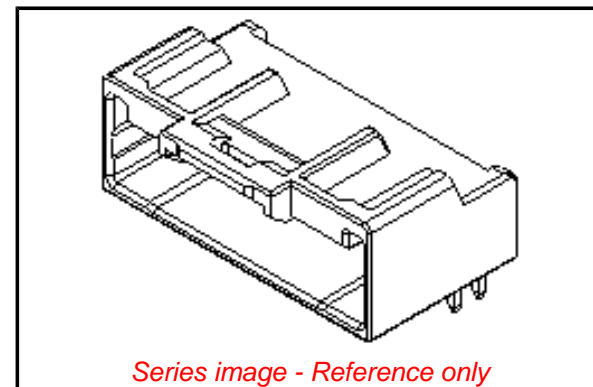

Series image - Reference only

EU ELV

Not Relevant

EU RoHS

Compliant

REACH SVHC

Not Contained Per
 -ED/79/2015 (17
 December 2015)

Halogen-Free

Status

Not Low-Halogen

**Need more information on product
 environmental compliance?**

Email productcompliance@molex.com
 Please visit the [Contact Us](#) section for any
 non-product compliance questions.

China ROHS

ELV

Green Image

Not Relevant

Search Parts in this Series

[501876](#) Series

Mates With

[501646](#) Housing, [501647](#) Crimp Terminal
 22-26 AWG, [501648](#) Crimp Terminal 26-28
 AWG

Reference - Drawing Numbers

Packaging Specification

Product Specification

Sales Drawing

SPK-501876-001

PS-501646-001, RPS-501646-001, RPS-501646-002,
RPS-501646-003, RPS-501646-004, RPS-501646-005,
RPS-501646-006, RPS-501646-007, RPS-501646-018
SD-501876-001

This document was generated on 03/30/2016

PLEASE CHECK WWW.MOLEX.COM FOR LATEST PART INFORMATION