

PLEASE CHECK WWW.MOLEX.COM FOR LATEST PART INFORMATION

Part Number: [52559-2253](#)
Status: **Active**
Overview: FFC-FPC (SMT)
Description: Easy-On™ Type FFC/FPC Connector, Vertical, SMT, ZIF, 22 Circuits, Lead-Free, Gold (Au) Contact Plating

Documents:

[3D Model](#) [Packaging Specification SPK-52559-001 \(PDF\)](#)
[Drawing \(PDF\)](#) [RoHS Certificate of Compliance \(PDF\)](#)
[Product Specification PS-52559-014 \(PDF\)](#)

Agency Certification

UL E29179

General

Product Family FFC/FPC Connectors
 Series [52559](#)
 Overview [FFC-FPC \(SMT\)](#)
 Product Name Easy-On™
 UPC 822350045339

Physical

Circuits (Loaded) 22
 Circuits (maximum) 22
 Color - Resin Natural
 Contact Position N/A
 Durability (mating cycles max) 20
 Entry Angle Vertical
 Flammability 94V-0
 Mated Height 3.90mm
 Material - Metal Phosphor Bronze
 Material - Plating Mating Gold
 Material - Plating Termination Tin
 Material - Resin High Temperature Thermoplastic
 Net Weight 292.102/mg
 Number of Rows 1
 Orientation Vertical
 PCB Locator No
 PCB Retention Yes
 Packaging Type Embossed Tape on Reel
 Pitch - Mating Interface 0.50mm
 Plating min - Mating 0.102µm
 Plating min - Termination 1.016µm
 Polarized to PCB No
 Stackable No
 Temperature Range - Operating -40°C to +85°C
 Termination Interface: Style Surface Mount
 Wire/Cable Type FFC/FPC

Electrical

Current - Maximum per Contact 0.5A
 Voltage - Maximum 50V AC (RMS)/DC

Material Info

Reference - Drawing Numbers

Packaging Specification SPK-52559-001

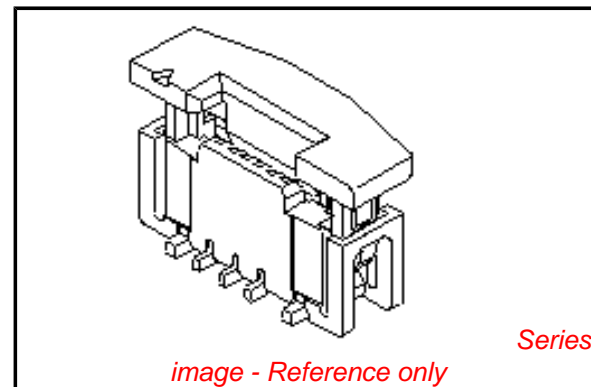

EU RoHS

ELV and RoHS Compliant
REACH SVHC Contains SVHC: No
Low-Halogen Status Not Low-Halogen

China RoHS



Need more information on product environmental compliance?

Email productcompliance@molex.com
 For a multiple part number RoHS Certificate of Compliance, [click here](#)

Please visit the [Contact Us](#) section for any non-product compliance questions.

Search Parts in this Series

[52559Series](#)

Product Specification

Sales Drawing

PS-52559-014, RPS-52559-062, RPS-52559-065,
RPS-52559-078
SD-52559-048, SD-52559-050

This document was generated on 03/26/2014

PLEASE CHECK WWW.MOLEX.COM FOR LATEST PART INFORMATION