

NOTE
 1. 嵌合相手: 51382-****
 2. 偶数極 (列) に適用。
 3. キングは両外側の位置に付加。
 4. 製品番号 MATERIAL NO.
 55935-****
 極数 CIRCUIT SIZE

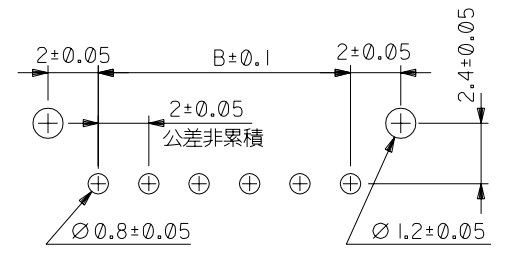

推奨基板寸法
 (t = 1.6)

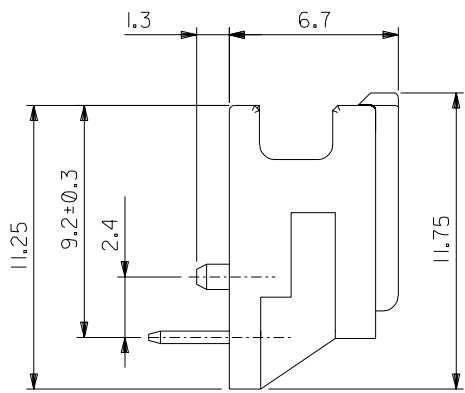
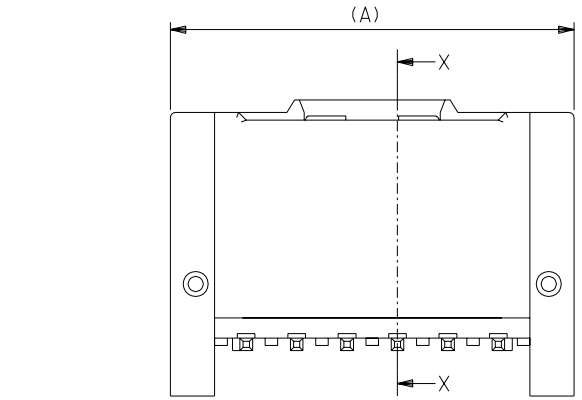

無鉛
 LEAD FREE

色 COLOR

10	自然色 (白) NATURAL (WHITE)
11	黒 BLACK
12	赤 RED
13	黄 YELLOW
14	青 BLUE
15	桃 PINK
16	緑 GREEN
17	茶 BROWN
18	橙 ORANGE
19	紫 VIOLET
41	灰 GRAY
43	蛍光黄 FLUORESCENCE YELLOW
44	水 PALE BLUE
46	黄緑 YELLOWISH GREEN

31	28	34	55935-15**	15
29	26	32	55935-14**	14
27	24	30	55935-13**	13
25	22	28	55935-12**	12
23	20	26	55935-11**	11
21	18	24	55935-10**	10
19	16	22	55935-09**	9
17	14	20	55935-08**	8
15	12	18	55935-07**	7
13	10	16	55935-06**	6
11	8	14	55935-05**	5
9	6	12	55935-04**	4
7	4	10	55935-03**	3
5	2	8	55935-02**	2
C	B	A	MATERIAL NO.	CKT.

DO NOT SCALE DRAWING

図番 NO. DRWN: CH'K: APPR:	図番 NO. DRWN: CH'K: APPR:	REVISED '03/6/12 図番 NO. J2003-3127 DRWN: N.IITO CH'K: K.ASAKAWA APPR: T.YAMAGUCHI	REVISED '03/4/04 図番 NO. J2003-2421 DRWN: N.IITO CH'K: K.ASAKAWA APPR: T.YAMAGUCHI	RELEASED '02/5/15 図番 NO. J2002-2827 DRWN: T.NIITSU CH'K: K.ASAKAWA APPR: T.YAMAGUCHI	DESCRIPTION 材料 ピン: 黄銅、ニッケル下地錫メッキ ハウジング: PBT
FINISH 仕上り	WIRE RANGE 適用線径範囲	GENERAL TOLERANCES: (UNLESS SPECIFIED) 一般公差			SCALE DESIGN UNITS <input checked="" type="checkbox"/> mm <input type="checkbox"/> INCH
INS. RANGE 被覆外径	ANGLE 角度	10 UNDER 未満 ±0.2 10 OVER 以上 30 UNDER 未満 ±0.25 30 OVER 以上 ±0.3	DRAWN BY & DATE T.NIITSU '02/5/15	CHECKED BY & DATE K.ASAKAWA '03/6/12	APPROVED BY & DATE T.YAMAGUCHI '03/6/12

MODEL NO.: 55935-**** DIMENSIONS: <input type="checkbox"/> mm <input type="checkbox"/> INCH <input checked="" type="checkbox"/> mm ONLY	SHT 2	REV 2
TITLE: 2.0 W/B SINGLE CONN. PLUG HOUSING ASS'Y R/A WITH BOSS	MOLEX INCORPORATED	
MATERIAL NO. 55935-****	DRAWING NO. SD-55935-005	SHEET NO. 1 of 2

2888 DRAWING CONTAINS INFORMATION THAT IS PROPRIETARY TO MOLEX INCORPORATED AND SHOULD NOT BE USED WITHOUT WRITTEN PERMISSION.

EN-02J(097) MXJ-54

DWG. NO. SD-55935-005

8 7 6 5 4 3 2 1

F

D

V

C

B

DO NOT SCALE DRAWING

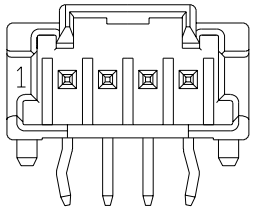
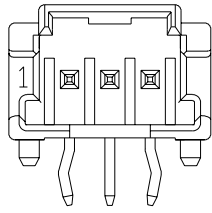
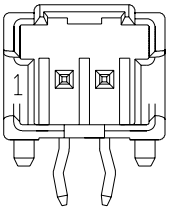
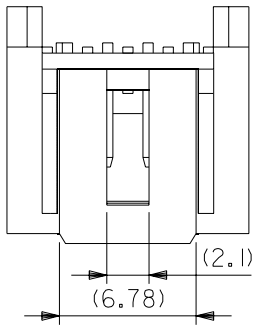
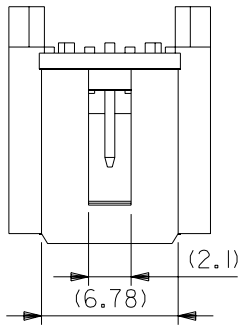
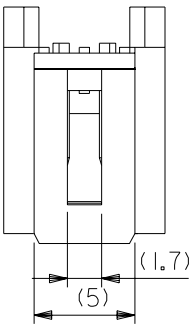

2 CIRCUIT

3 CIRCUIT

4 CIRCUIT

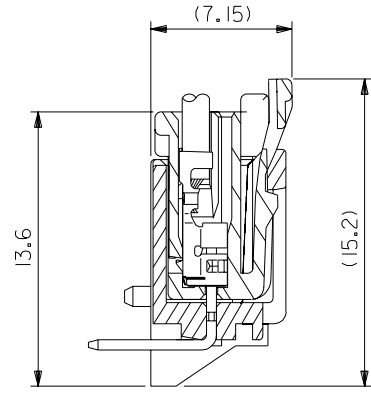

嵌合断面図

無鉛
LEAD FREE

64 NO. DRWN: CH'K: APPR:	63 NO. DRWN: CH'K: APPR:	REVISED '03/6/12 62 NO. J2003-3127 DRWN: N.ITO CH'K: K.ASAKAWA APPR: T.YAMAGUCHI	REVISED '03/4/04 61 NO. J2003-2421 DRWN: N.ITO CH'K: K.ASAKAWA APPR: T.YAMAGUCHI	RELEASED '02/5/15 60 NO. J2002-2827 DRWN: T.NIITSU CH'K: K.ASAKAWA APPR: T.YAMAGUCHI	MATERIAL 材料	GENERAL TOLERANCES: (UNLESS SPECIFIED) 一般公差		SCALE DESIGN UNITS <input checked="" type="checkbox"/> mm <input type="checkbox"/> INCH	MODEL NO. : 55935-**** DIMENSIONS: <input type="checkbox"/> mm <input type="checkbox"/> INCH <input checked="" type="checkbox"/> mm ONLY	SHT REV	REVISE ON CAD ONLY
						FINISH 仕上げ	WIRE RANGE 適用線径範囲				
DRAWN BY & DATE T.NIITSU '02/5/15						TITLE: 2.0 W/B SINGLE CONN. PLUG HOUSING ASS'Y R/A WITH BOSS					
CHECKED BY & DATE K.ASAKAWA '03/6/12						APPROVED BY & DATE T.YAMAGUCHI '03/6/12					
CAD FILENAME SD-55935-005.S02						MATERIAL NO. 55935-****		DRAWING NO. SD-55935-005		SHEET NO. 2 of 2	
THIS DRAWING CONTAINS INFORMATION THAT IS PROPRIETARY TO MOLEX INCORPORATED AND SHOULD NOT BE USED WITHOUT WRITTEN PERMISSION.						MOLEX INCORPORATED		SIZE B		SD 55935.S02	

8 7 6 5 4 3 2 1 EN-02J(097) MXJ-54

F

E

D

C

B

A