

SMD/BLOCK Type EMI Suppression Filters

EMIFIL[®]

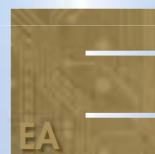

*Innovator
in Electronics*

**Murata
Manufacturing Co., Ltd.**















⚠Note • Please read rating and ⚠CAUTION (for storage, operating, rating, soldering, mounting and handling) in this catalog to prevent smoking and/or burning, etc.
• This catalog has only typical specifications. Therefore, please approve our product specifications or transact the approval sheet for product specifications before ordering.

C31E.pdf
Aug.1,2013

Introduction

Murata Manufacturing Co., Ltd. has been developing the EMI suppression device market since the invention of 3 terminal capacitor DS310 series in 1979. Also, we have been striving to develop and popularize new noise countermeasure technologies as well as new products in the concept of "Develop unique products," to become our customer's best solution partner. We hope you can find the key solution to your noise problem.

Explanation of symbols in this catalog

	Features of each series	Features of each item
All Products	 Flow Flow soldering available	 New New product
	 Reflow Reflow soldering available	 Kit Exist in design kit
	 Hi Power Meets large current lines	 ≥1A Rated current 1A or more
Chip Ferrite Bead	 GHz Meets high frequency noise up to 1-2GHz	 ≥3A Rated current 3A or more
	 Hi-GHz Meets ultra high frequency noise up to 10GHz	 ≥10A Rated current 10A or more
LC Combined Type Filter		 DTV Low cut-off frequency type for UHF band noise, which affects digital TV tuner
Chip Common Mode Choke Coil		 HD For high speed differential signal lines (USB2.0/LVDS/IEEE1394 etc.)
		 UD For ultra high speed differential signal lines (HDMI/DVI/Display Port/USB3.0 etc.)
		 Imp Match Line impedance has been matched to transmission lines

EU RoHS Compliant

- All the products in this catalog comply with EU RoHS.
- EU RoHS is "the European Directive 2011/65/EU on the Restriction of the Use of Certain Hazardous Substances in Electrical and Electronic Equipment."
- For more details, please refer to our website 'Murata's Approach for EU RoHS' (<http://www.murata.com/info/rohs.html>).

CONTENTS

Selection Guide for Noise Suppression Filters	2
EMI Filter Selection by Application	4
•Digital Still Camera	4
•Blu-ray/DVD	6
•Smartphone	5
•LCD-TV	7
EMI Filter Selection by Circuits and Noise Frequency	8
Product Guide	10



BL Chip Ferrite Bead

Series Introduction	14
Part Numbering	16
Series Lineup	17
Product Detail	23
⚠Caution/Notice	96
Soldering and Mounting	97
Packaging	101
Design Kits	102

Chip Ferrite Bead



NF Chip EMIFIL®

Series Introduction	108
Part Numbering	110
Series Line Up	113
Product Detail	116
⚠Caution/Notice	146
Soldering and Mounting	147
Packaging	153
Design Kits	155

Chip EMIFIL®



DL/PL Chip Common Mode Choke Coil

Series Introduction	160
Part Numbering	162
Series Line Up	164
Product Detail	167
⚠Caution/Notice	192
Soldering and Mounting	194
Packaging	200
Design Kits	202

Chip Common Mode Choke Coil



BNX Block Type EMIFIL®

Series Line Up	206
Function Example	206
Product Detail	209
⚠Caution/Notice	213
Soldering and Mounting	215
Packaging	219
Design Kits	220

Block Type EMIFIL®



EA Microwave Absorber

Part Numbering	222
Product Detail	223
Notice	226



Microwave Absorber

Product Guide by Size	227
Part Number Quick Reference	228
Alphabetic Product Name Index	228
Introduction of Related Catalogs	229
Introduction of EMI/MLCC/Inductor special web site "EMICON-FUN!"	230

⚠Note • Please read rating and ⚠CAUTION (for storage, operating, rating, soldering, mounting and handling) in this catalog to prevent smoking and/or burning, etc.
• This catalog has only typical specifications. Therefore, please approve our product specifications or transact the approval sheet for product specifications before ordering.

Selection Guide for Noise Suppression Filters

● Features & Suitable Circuits

Type	Features	Suitable Circuits
Ferrite Bead BLM/BLA Series 	<ul style="list-style-type: none"> · Miniaturized · GND connection unnecessary · Effective at low impedance line 	<ul style="list-style-type: none"> · Application set with less noise radiation · Low impedance line
Capacitor Type NFM/NFA/NFE/NFR/ NFL/NFW Series 	<ul style="list-style-type: none"> · Great noise suppression effect · With effect as By-Pass capacitor (Lineup for Power) · Good noise separation from signal (LC filter for Signal) · Effective at high impedance line 	<ul style="list-style-type: none"> · Application set with higher noise radiation · High impedance line · Circuit with By-Pass capacitor · Circuit driven by high frequency
Common Mode Choke Coil 	<ul style="list-style-type: none"> · Possible to suppress noise with less affect of ultra high speed signal · Great effect for common mode noise · Less magnetic saturation by current 	<ul style="list-style-type: none"> · High speed differential signal line · I/F cable driver · Power line

● Example

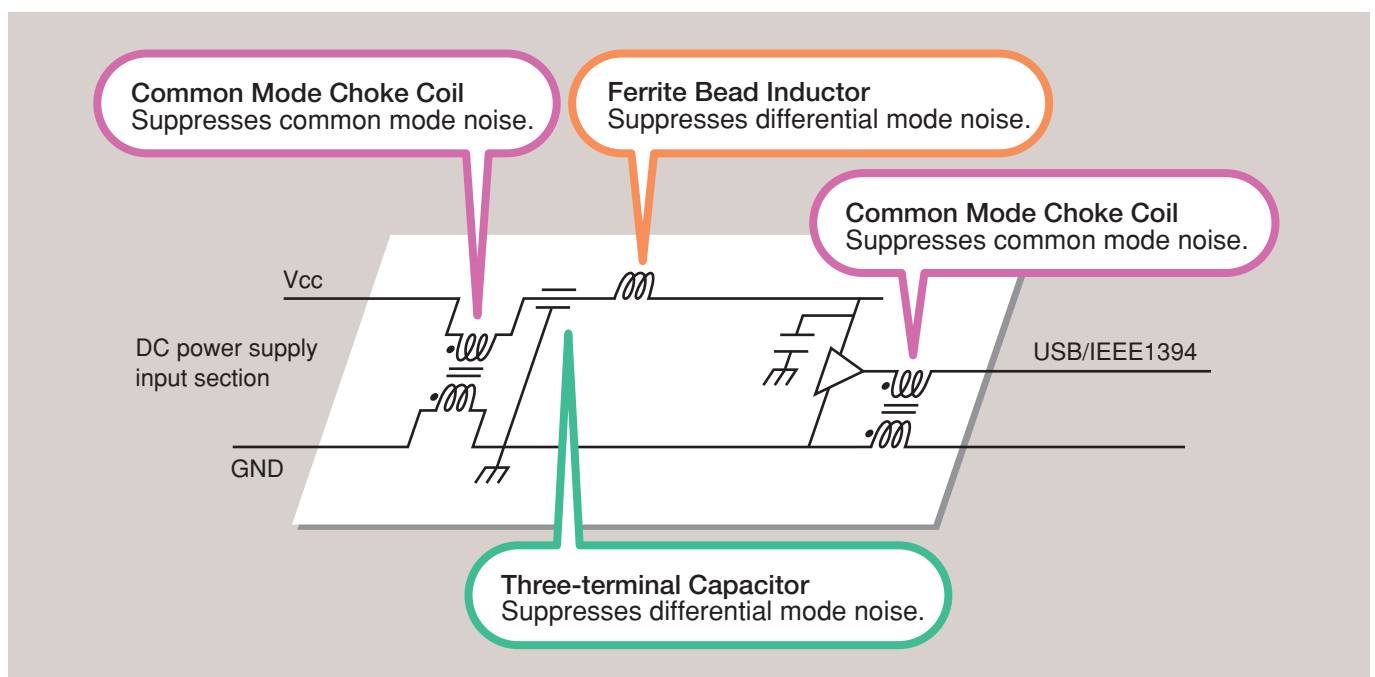

△Note • Please read rating and △CAUTION (for storage, operating, rating, soldering, mounting and handling) in this catalog to prevent smoking and/or burning, etc.
 • This catalog has only typical specifications. Therefore, please approve our product specifications or transact the approval sheet for product specifications before ordering.

● Advantages to Using Common Mode Choke Coils



1. Great Effect for Common Mode Noise

Differential mode inductors work as a half impedance for common mode noise. Common Mode Choke Coils are effective for common mode noise.

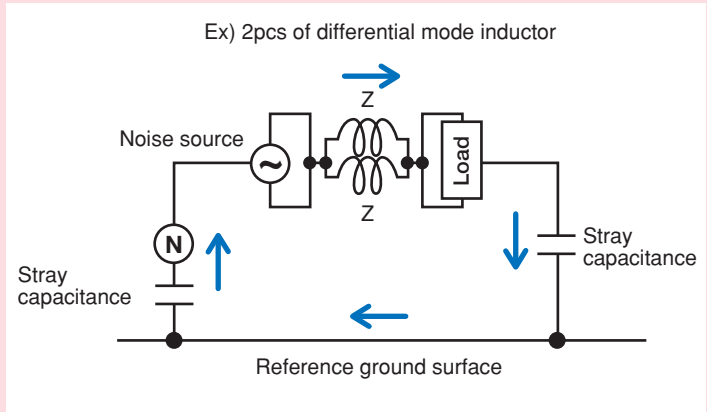

2. Possible to Suppress Noise with Less Affect of Ultra High Speed Signal

Common Mode Choke Coils can suppress Noise with less affect of Signal, even if the frequency range of Signal and Noise are the same, because they separate each conductive mode of current.

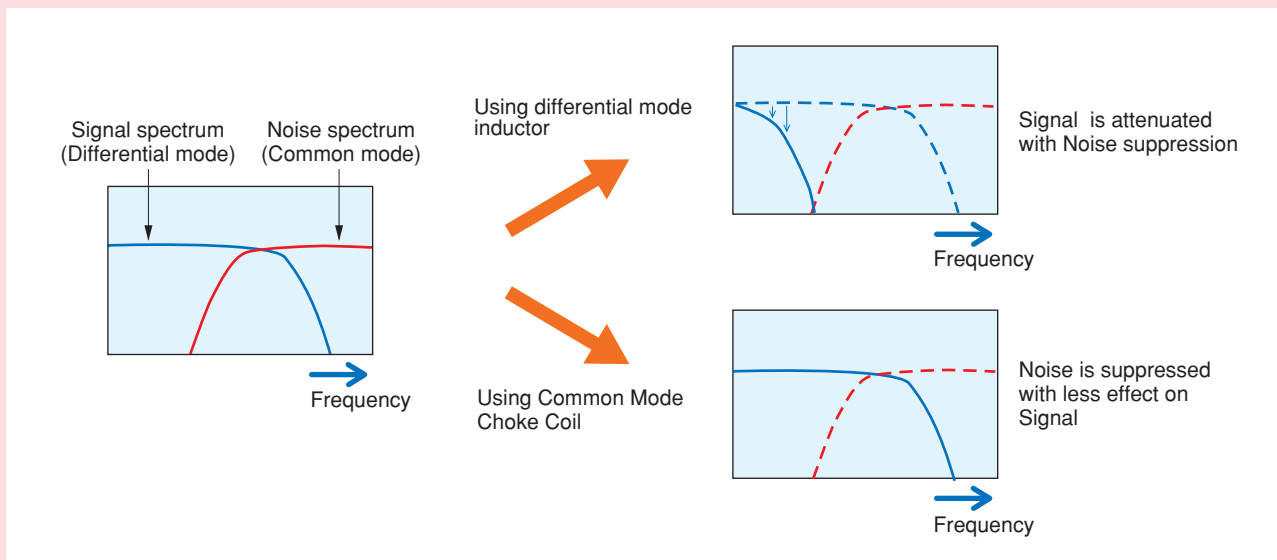

3. Less Magnetic Saturation by Current

Common Mode Choke Coils are effective for noise suppression of DC power lines, due to their less magnetic saturation at high power current, that comes from their construction of cancelling magnetic flux of differential mode current at each coil.

△Note • Please read rating and △CAUTION (for storage, operating, rating, soldering, mounting and handling) in this catalog to prevent smoking and/or burning, etc.
• This catalog has only typical specifications. Therefore, please approve our product specifications or transact the approval sheet for product specifications before ordering.

Digital Still Camera

Application Sample

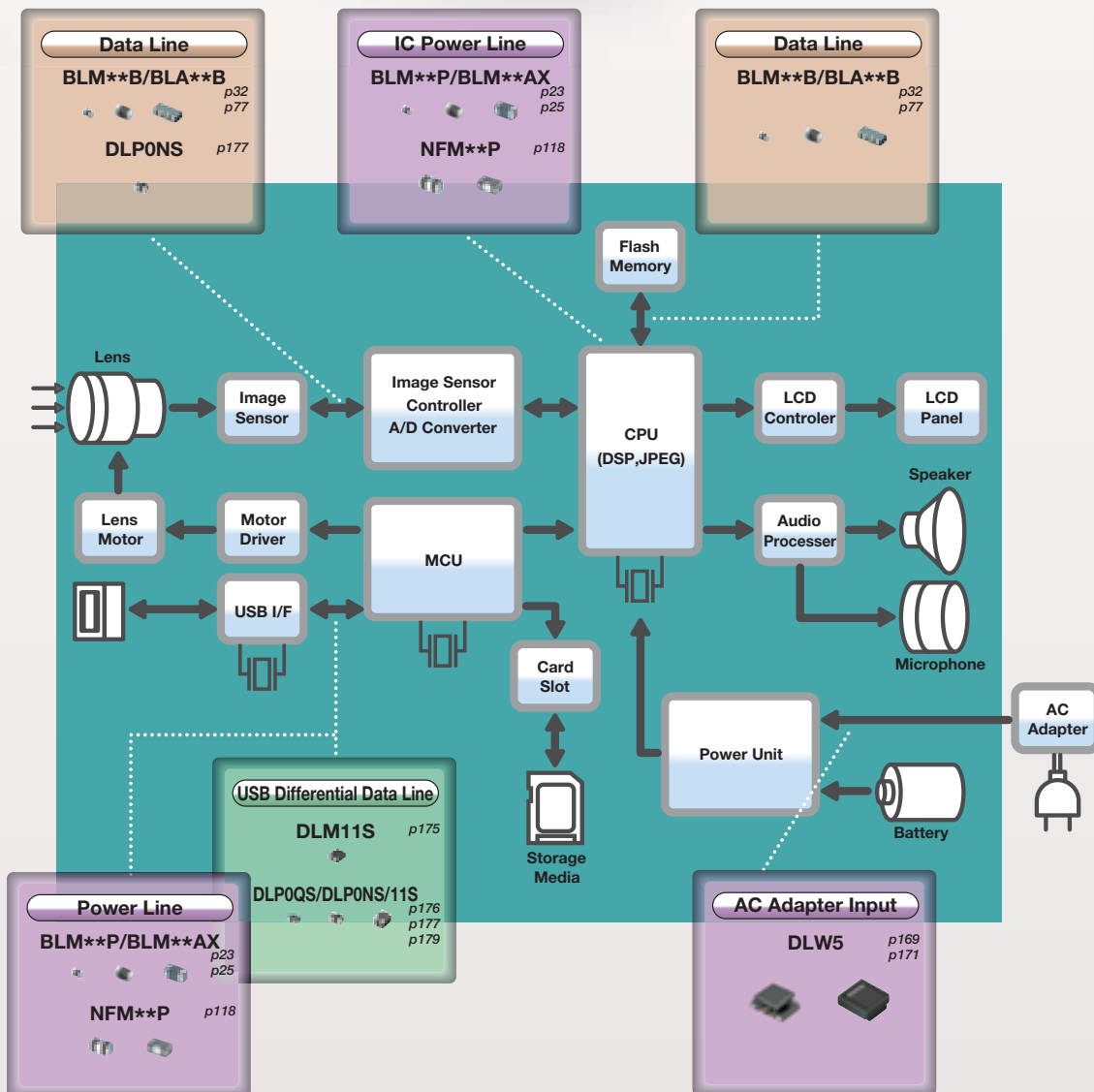

△Note • Please read rating and △CAUTION (for storage, operating, rating, soldering, mounting and handling) in this catalog to prevent smoking and/or burning, etc.
 • This catalog has only typical specifications. Therefore, please approve our product specifications or transact the approval sheet for product specifications before ordering.

Smartphone

Application Sample

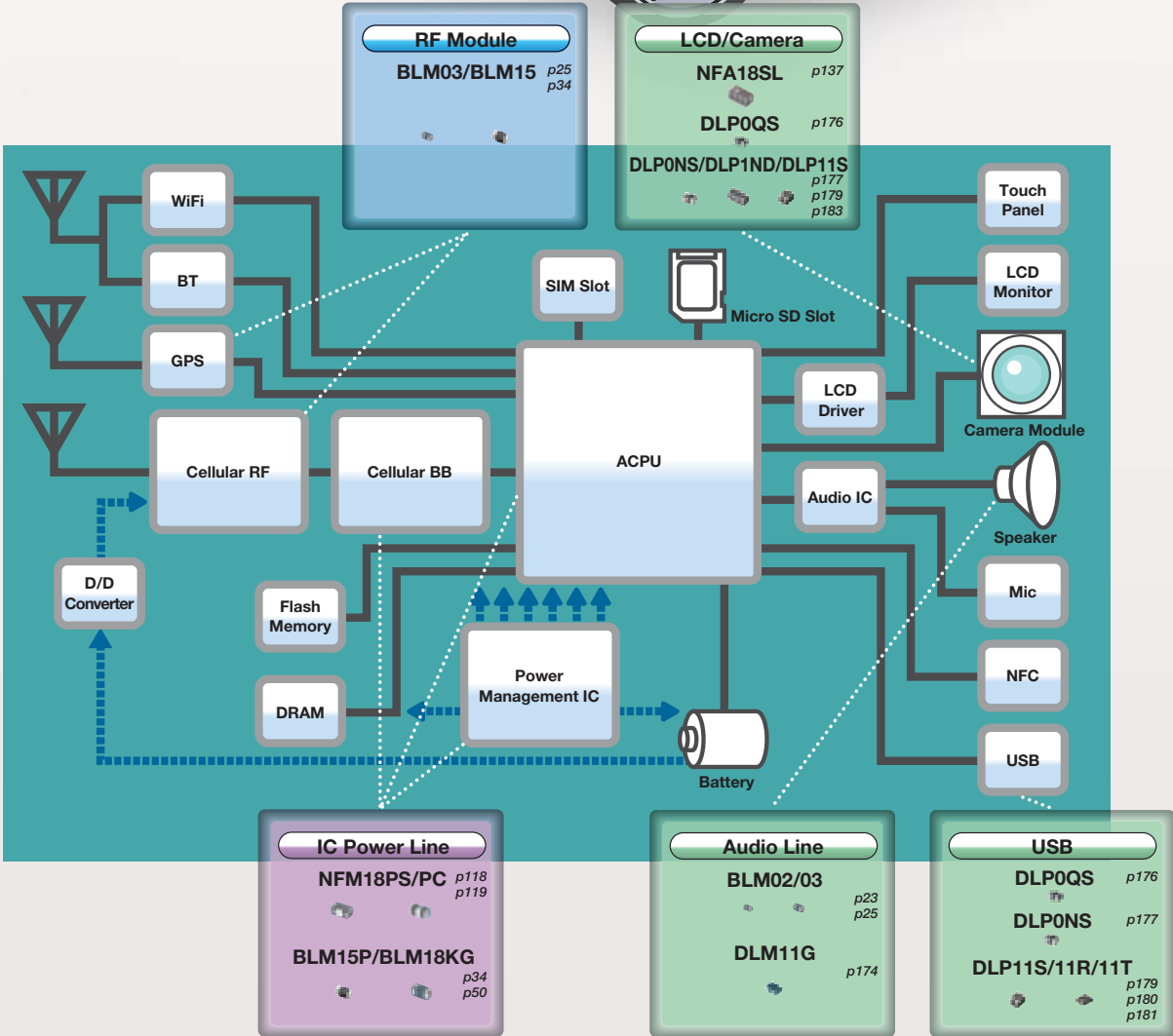

⚠Note • Please read rating and ⚠CAUTION (for storage, operating, rating, soldering, mounting and handling) in this catalog to prevent smoking and/or burning, etc.
• This catalog has only typical specifications. Therefore, please approve our product specifications or transact the approval sheet for product specifications before ordering.

Blu-ray/DVD

Application Sample

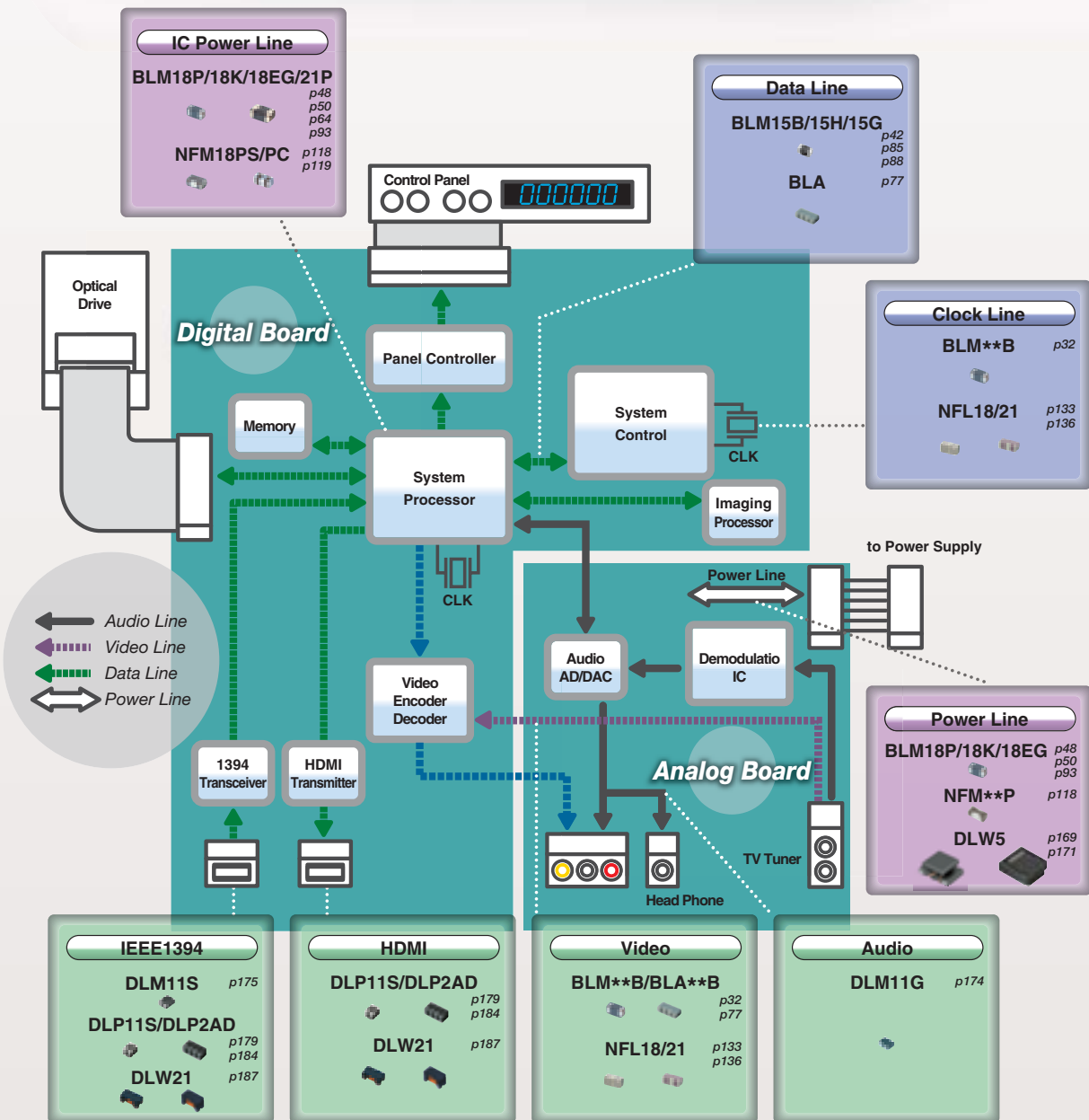

△Note • Please read rating and △CAUTION (for storage, operating, rating, soldering, mounting and handling) in this catalog to prevent smoking and/or burning, etc.
 • This catalog has only typical specifications. Therefore, please approve our product specifications or transact the approval sheet for product specifications before ordering.

LCD-TV
Application Sample

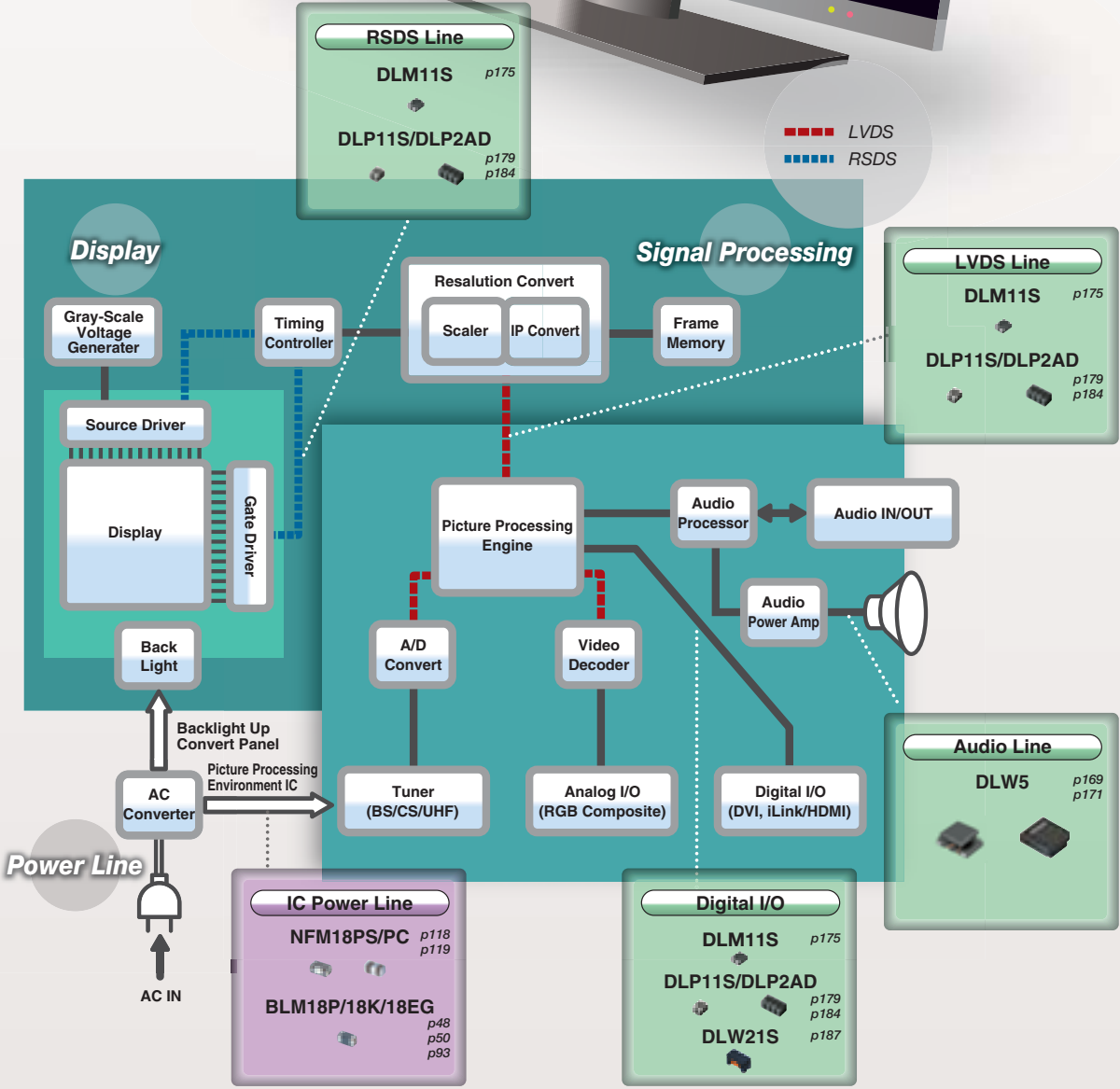

△Note • Please read rating and △CAUTION (for storage, operating, rating, soldering, mounting and handling) in this catalog to prevent smoking and/or burning, etc.
• This catalog has only typical specifications. Therefore, please approve our product specifications or transact the approval sheet for product specifications before ordering.

EMI Filter Selection by Circuits and Noise Frequency

● Chip Ferrite Bead / Chip EMIFIL®

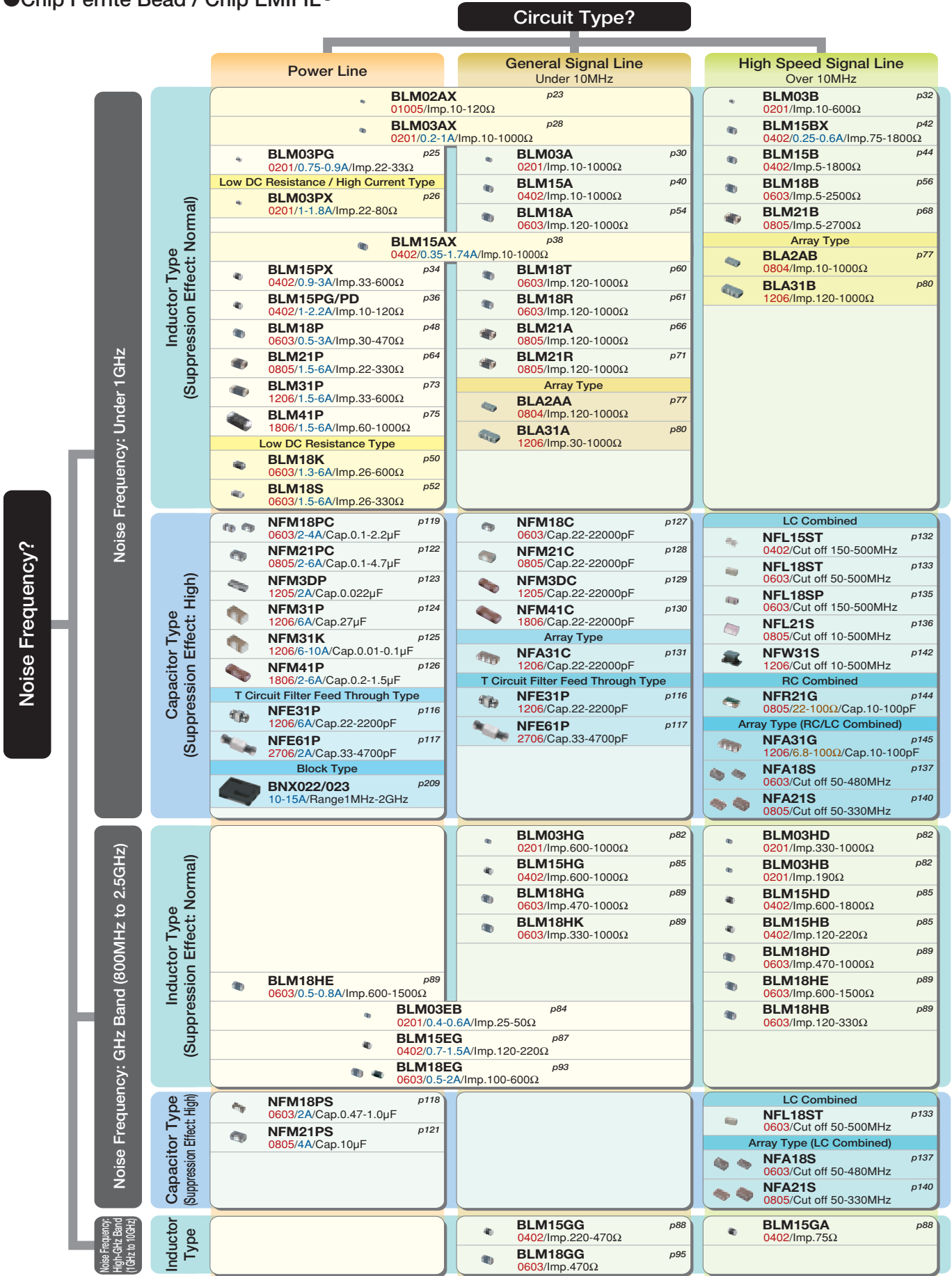

△Note • Please read rating and △CAUTION (for storage, operating, rating, soldering, mounting and handling) in this catalog to prevent smoking and/or burning, etc.
• This catalog has only typical specifications. Therefore, please approve our product specifications or transact the approval sheet for product specifications before ordering.

●Chip Common Mode Choke Coil

Circuit Type?

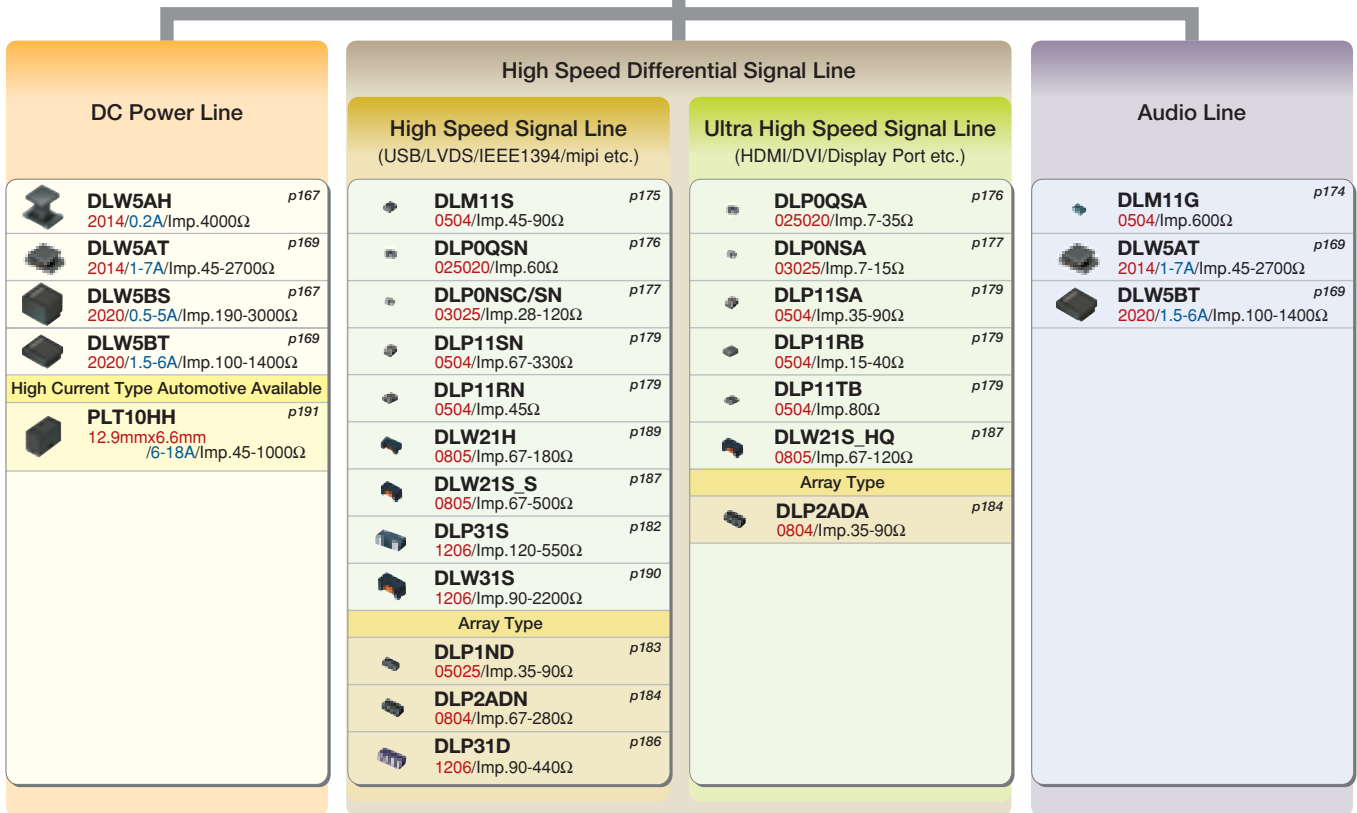

Guide of Digits in this Chart:

●for BLM03P

0201/0.75-0.9A/Imp.22-33Ω
 Size (inch) Rated Current Impedance

●for NFA18S

0603/Cut off 50-480MHz
 Size (inch) Cut-off Frequency

●for BNX022/023

10-15A/Range1MHz-2GHz
 Rated Current Effective Frequency Range

●for DLW5BS

2020/0.5-5A/Imp.190-3000Ω
 Size (inch) Rated Current Impedance

●for NFR21G

0805/22-100Ω/Cap.10-100pF
 Size (inch) Resistance Capacitance

△Note • Please read rating and △CAUTION (for storage, operating, rating, soldering, mounting and handling) in this catalog to prevent smoking and/or burning, etc.
 • This catalog has only typical specifications. Therefore, please approve our product specifications or transact the approval sheet for product specifications before ordering.



Inductor Type		Series	Size Code Inch (mm)	Impedance (Ω) at 100MHz			Effective Frequency Range (Applicable Frequency Ranges are only for reference.)															
				10	100	1000	10kHz	100kHz	1MHz	10MHz	100MHz	1GHz	10GHz									
For General Band Noise	Universal Type [Power Lines / Signal Lines]	BLM02AX ^{p23}	01005 (0402)	10	70	120																
		BLM03AX ^{p28}	0201 (0603)	10	80	120	240	600	1000													
		BLM15AX ^{p38}	0402 (1005)	10	30	70	120	220	600	1000												
	Signal Lines Type	For General Signal Lines	BLM03AG ^{p30}	0201 (0603)	10	80	120	240	600	1000												
			BLM15AG ^{p40}	0402 (1005)	10	70	120	220	600	1000												
			BLM18A ^{p54}	0603 (1608)				220	470	600	1000											
			BLM21A ^{p66}	0805 (2012)				220	470	600	1000											
			BLM18T ^{p60}	0603 (1608)				120	220	600	1000											
			BLA2AA ^{p77} (4 circuits array)	0804 (2010)				120	220	600	1000											
			BLA31A ^{p80} (4 circuits array)	1206 (3216)	30	60	120	220	600	1000												
		For High Speed Signal Lines	BLM03B ^{p32}	0201 (0603)	10	22	33	56	80	470	600											
			BLM15B ^{p42}	0402 (1005)	5	10	22	33	75	120	240	470	600	1800								
			BLM18B ^{p56}	0603 (1608)	5	10	22	33	75	140	220	420	600	1500	2200							
	BLM21B ^{p68}		0805 (2012)	5			75	200	330	470	750	1500	2200	2700								
	BLA2AB ^{p77} (4 circuits array)		0804 (2010)	10	22	47	75	120	220	470	600	1000										
	For Digital Interface Lines	BLA31B ^{p80} (4 circuits array)	1206 (3216)				120	220	470	600	1000											
		BLM18R ^{p61}	0603 (1608)				120	220	470	600	1000											
	Power Lines Type	BLM03PX* ^{p26}	0201 (0603)				33 (1.5A)	80 (1A)														
		BLM03PG ^{p25}	0201 (0603)				33 (0.75A)															
		BLM15P* ^{p34}	0402 (1005)	10 (1A)	30 (2.2A)	60 (1.7A/2.5A)	120 (1.3A/2A)	330 (1.2A)	600 (0.9A)													
BLM18P* ^{p48}		0603 (1608)	30 (1A)	60 (0.5A)	180 (1.5A)	330 (1.2A)																
BLM21P* ^{p64}		0805 (2012)	30 (4A)	22 (6A)	60 (3.5A)	120 (3A)	330 (1.5A)															
BLM31P* ^{p73}		1206 (3216)	50 (3.5A)	33 (6A)	120 (3.5A)		390 (2A)	600 (1.5A)														
BLM41P* ^{p75}		1806 (4516)	75 (3.5A)	60 (6A)	180 (3.5A)		470 (2A)	1000 (1.5A)														
BLM18K* ^{p50} (Low DC Resistance Type)		0603 (1608)	30 (5A)	26 (6A)	70 (3.5A)	100 (3A)	220 (2.2A)	470 (1.5A)														
BLM18S* ^{p52} (Low DC Resistance Type)		0603 (1608)	70 (4A)	26 (6A)	120 (3A)	330 (1.5A)																
For GHz Band Noise		Universal Type [Power Lines / Signal Lines]	BLM03EB* ^{p84}	0201 (0603)			25 (0.6A)	50 (0.4A)														
	BLM15EG* ^{p87}		0402 (1005)					220 (0.7A)	120 (1.5A)													
	BLM18EG* ^{p93}		0603 (1608)					120 (2A)	330 (0.5A)	470 (0.5A)	100 (2A)	220 (2A/1A)	390 (0.5A)	600 (0.5A)								
	BLM18HE* ^{p89}		0603 (1608)						1000 (0.6A)	600 (0.8A)	1500 (0.5A)											
	Signal Lines Type	BLM03HG ^{p82}	0201 (0603)						600	1000												
		BLM03HD ^{p82}	0201 (0603)						330	470	1000											
		BLM03HB ^{p82}	0201 (0603)					190														
		BLM15HG ^{p85}	0402 (1005)						600	1000												
		BLM15HD ^{p85}	0402 (1005)						600	1000	1800											
		BLM15HB ^{p85}	0402 (1005)				120	220														
		BLM18HG ^{p89}	0603 (1608)						600	470	1000											
		BLM18HD ^{p89}	0603 (1608)						600	470	1000											
		BLM18HB ^{p89}	0603 (1608)				120	220	330													
		BLM18HK ^{p89}	0603 (1608)							600	330	470	1000									
		Signal Lines Type	BLM15GG ^{p88}	0402 (1005)						220	470											
BLM15GA ^{p88}	0402 (1005)					75																
BLM18GG ^{p95}	0603 (1608)								470													

* The derating of rated current is required for some items according to the operating temperature on each product page.

△Note • Please read rating and △CAUTION (for storage, operating, rating, soldering, mounting and handling) in this catalog to prevent smoking and/or burning, etc.
• This catalog has only typical specifications. Therefore, please approve our product specifications or transact the approval sheet for product specifications before ordering.





Capacitor Type	Series	Size Code Inch (mm)	Capacitance (F)							Effective Frequency Range (Applicable Frequency Ranges are only for reference.)						
			10p	100p	1000p	10000p	0.1μ	1μ	10μ	10kHz	100kHz	1MHz	10MHz	100MHz	1GHz	10GHz
Signal Lines Type	NFM18C <small>p127</small>	0603 (1608)			470	2200										
	NFM21C <small>p128</small>	0805 (2012)			470	2200										
	NFM3DC <small>p129</small>	1205 (3212)			470	2200										
	NFM41C <small>p130</small>	1806 (4516)			470	2200										
	NFA31C (4 circuits array) <small>p131</small>	1206 (3216)			470	2200										
Power Lines Type	NFM18P <small>p118</small>	0603 (1608)							0.22	1.0						
	NFM21P <small>p121</small>	0805 (2012)							0.1	0.47	2.2					
	NFM3DP* <small>p123</small>	1205 (3212)					22000									
	NFM31P <small>p124</small>	1206 (3216)													27	
	NFM31K* <small>p125</small>	1206 (3216)				10000	22000									
	NFM41P <small>p126</small>	1806 (4516)							0.2	1.5						
Universal Type [Power Lines / Signal Lines]	NFE31P <small>p116</small>	1206 (3216)			470	2200										
	NFE61P <small>p117</small>	2706 (6816)			100	360	1000									
			33	68	180	680	4700									



LC(RC) Combined Type	Series	Size Code Inch (mm)	Cut-off Frequency (MHz)							Effective Frequency Range (Applicable Frequency Ranges are only for reference.)						
			10	100	500	10	100	500	10kHz	100kHz	1MHz	10MHz	100MHz	1GHz	10GHz	
Signal Lines Type	NFL15ST <small>p132</small>	0402 (1005)				150	200	300	500							
	NFL18ST <small>p133</small>	0603 (1608)				50	70	100	200	300	500					
	NFL18SP <small>p135</small>	0603 (1608)					150	200	300	500						
	NFL21S <small>p136</small>	0805 (2012)													500	
	NFA18S (4 circuits array) <small>p137</small>	0603 (1608)								200	400					
	NFA21S (4 circuits array) <small>p140</small>	0805 (2012)								280	310					
	NFW31S <small>p142</small>	1206 (3216)								200	300	330				
	NFR21G <small>p144</small>	0805 (2012)														
	NFA31G (4 circuits array) <small>p145</small>	1206 (3216)														

* The derating of rated current is required for some items according to the operating temperature on each product page.

⚠Note • Please read rating and ⚠CAUTION (for storage, operating, rating, soldering, mounting and handling) in this catalog to prevent smoking and/or burning, etc.
• This catalog has only typical specifications. Therefore, please approve our product specifications or transact the approval sheet for product specifications before ordering.

DL

Common Mode Choke Coils

Signal Lines Type	Series	Size Code Inch (mm)	Common Mode Impedance (Ω) at 100MHz			Effective Frequency Range (Applicable Frequency Ranges are only for reference.)				
			100	500	1000	1MHz	10MHz	100MHz	1GHz	10GHz
For Audio Lines For Ultra High Speed Signal Lines	DLM11G ^{p174}	0504 (1210)		600						
	DLM11S ^{p175}	0504 (1210)	45 90							
	DLP0QSN ^{p176}	025020 (0605)	60							
	DLP0QSA ^{p176}	025020 (0605)	15 7 35							
	DLP0NSC ^{p177}	03025 (0806)	28							
	DLP0NSN ^{p177}	03025 (0806)	35 90 67 120							
	DLP0NSA ^{p177}	03025 (0806)	15 7							
	DLP11SN ^{p179}	0504 (1210)	67 90 120 160 200 280 330	240						
	DLP11SA ^{p179}	0504 (1210)	35 90 67							
	DLP11RN ^{p180}	0504 (1210)	45							
	DLP11RB ^{p180}	0504 (1210)	15 40							
	DLP11TB ^{p181}	0504 (1210)	80							
	DLP31S ^{p182}	1206 (3216)	120 220 550							
	DLP1NDN (2 circuits array) ^{p183}	05025 (1506)	35 90 67							
	DLP2ADA (2 circuits array) ^{p184}	0804 (2010)	35 90 67							
	DLP2ADN (2 circuits array) ^{p184}	0804 (2010)	90 120 160 200 280	240						
	DLP31DN (2 circuits array) ^{p186}	1206 (3216)	90 130 200 320 440							
	DLW21S ^{p187}	0805 (2012)	67 90 120 180 260 370 500							
	DLW21H ^{p189}	0805 (2012)	90 120 180							
	DLW31SN ^{p190}	1206 (3216)	90 160 260 600 1000 2200							
Universal Type [Power Lines / Signal Lines]	DLW5AH/DLW5BS* ^{p167}	2014 / 2020 (5036) / (5050)	190 350 1000 3000	1500 4000						
	DLW5AT*/DLW5BT* ^{p169}	2014 / 2020 (5036) / (5050)	50 110 230 330 500 850 1100 2700	1000 1400						

PL

Large Current Common Mode Choke Coil for Automotive Available

Large Current Type for Automotive Available	Series	Size Code Inch (mm)	Common Mode Impedance (Ω) at 100MHz			Effective Frequency Range (Applicable Frequency Ranges are only for reference.)				
			100	500	1000	100kHz	1MHz	10MHz	100MHz	1GHz
	PLT10HH* ^{p191}	-	45 100	400 500	900 1000 (at 10MHz)					

BNX

Block EMIFIL®

Power Lines Type	Series	Height (mm)	Rated Voltage (Vdc)	Rated Current (A)	Effective Frequency Range (Applicable Frequency Ranges are only for reference.)						
					10kHz	100kHz	1MHz	10MHz	100MHz	1GHz	10GHz
SMD Type	BNX022* ^{p209}	3.1	50	10							
	BNX023* ^{p209}	3.1	100	15							
	BNX024* ^{p209}	3.5	50	15							
	BNX025* ^{p209}	3.5	25	15							
	Lead Type	BNX002 ^{p211}	13 max.	50	10						
		BNX003 ^{p211}	13 max.	150	10						
		BNX005 ^{p211}	13.5 max.	50	15						
		BNX012* ^{p212}	8.0 max.	50	15						
		BNX016* ^{p212}	8.0 max.	25	15						

* The derating of rated current is required for some items according to the operating temperature on each product page.

△Note • Please read rating and △CAUTION (for storage, operating, rating, soldering, mounting and handling) in this catalog to prevent smoking and/or burning, etc.
• This catalog has only typical specifications. Therefore, please approve our product specifications or transact the approval sheet for product specifications before ordering.



Chip Ferrite Bead

Series Introduction	14
Part Numbering	16
Series Line Up	17
Product Detail	23
⚠Caution/Notice	96
Soldering and Mounting	97
Packaging	101
Design Kits	102

Chip Ferrite Bead

Chip EMIFIL®

Chip Common Mode Choke Coil

Block Type EMIFIL®

Microwave Absorber

⚠Note • Please read rating and ⚠CAUTION (for storage, operating, rating, soldering, mounting and handling) in this catalog to prevent smoking and/or burning, etc.
• This catalog has only typical specifications. Therefore, please approve our product specifications or transact the approval sheet for product specifications before ordering.

BL Series Introduction

● Example of Chip Ferrite Bead BLM Series Structure

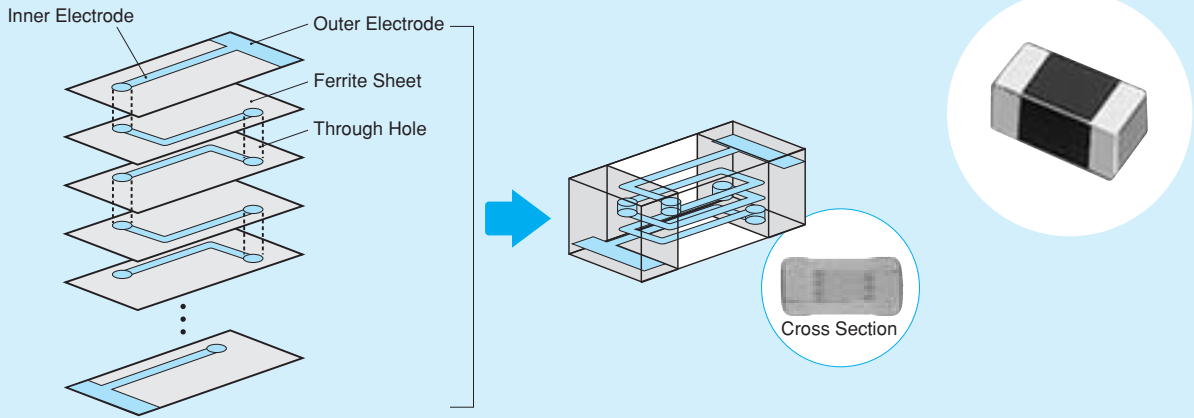

● Line Up Classification of Chip Ferrite Bead

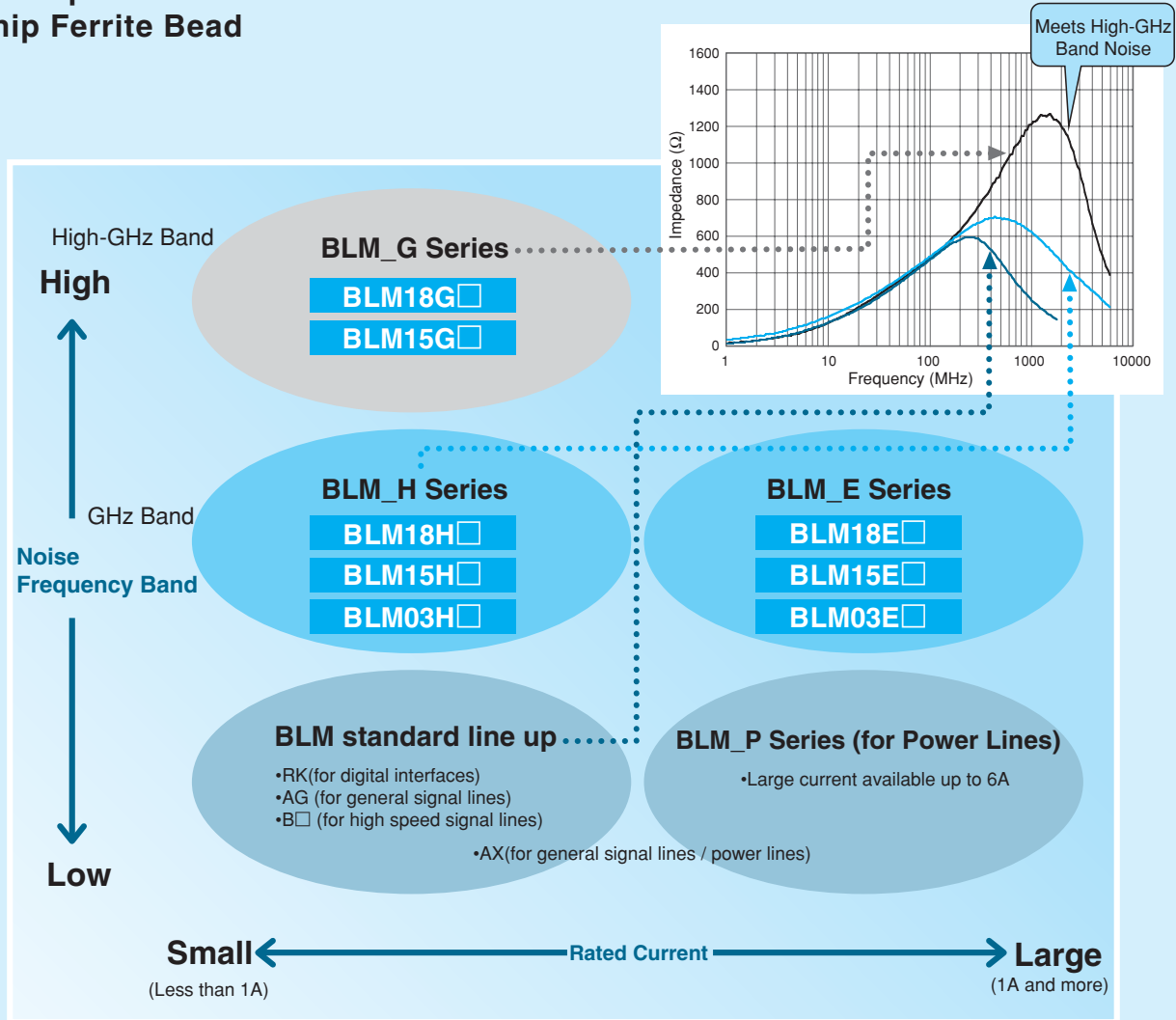

△Note • Please read rating and △CAUTION (for storage, operating, rating, soldering, mounting and handling) in this catalog to prevent smoking and/or burning, etc.
• This catalog has only typical specifications. Therefore, please approve our product specifications or transact the approval sheet for product specifications before ordering.

Chip Ferrite Bead
Chip EMIFIL®
Chip Common Mode Choke Coil
Block Type EMIFIL®
Microwave Absorber

●Difference between BLM A type and B type (HG type vs HD/HB/HE type)

A type: Impedance curve rises from low frequency range. Suppresses noise in a wide frequency range.
 B type: Impedance curve rises sharply. Less damage to signal waveforms.

■Comparison of Impedance Curve

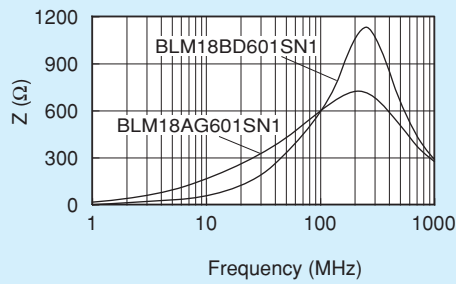

■Comparison of Resistance Element

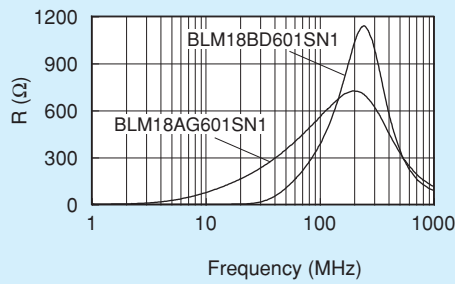

■Comparison of Test Effect (25MHz)

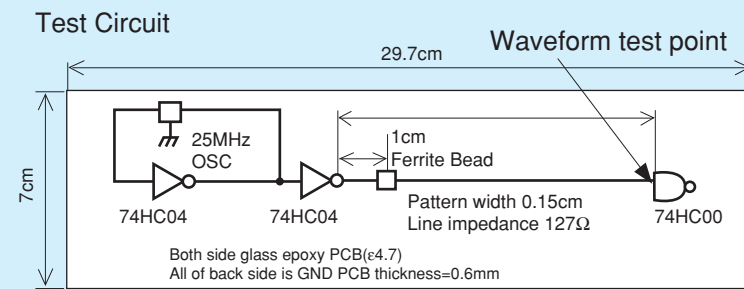

BLM_B Series has less damage to high speed signal waveform.

Waveform

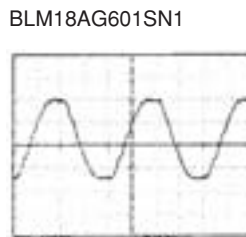
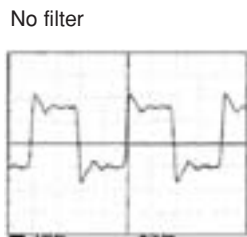

Spectrum

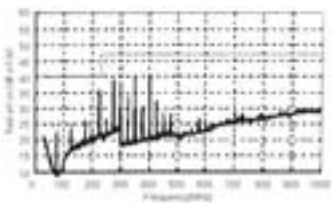
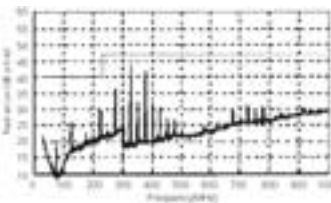
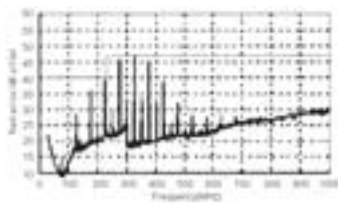

Spectrum has been reduced from low frequency range.

Noise frequency has been reduced without reducing signals of low frequency.

△Note • Please read rating and △CAUTION (for storage, operating, rating, soldering, mounting and handling) in this catalog to prevent smoking and/or burning, etc.
 • This catalog has only typical specifications. Therefore, please approve our product specifications or transact the approval sheet for product specifications before ordering.

BL Chip Ferrite Bead Part Numbering

(Part Number)

BL	M	18	AG	102	S	N	1	D
①	②	③	④	⑤	⑥	⑦	⑧	⑨

① Product ID

Product ID	
BL	Chip Ferrite Beads

② Type

Code	Type
A	Array Type
M	Ferrite Bead Single Type

③ Dimensions (L×W)

Code	Dimensions (L×W)	EIA
02	0.4×0.2mm	01005
03	0.6×0.3mm	0201
15	1.0×0.5mm	0402
18	1.6×0.8mm	0603
2A	2.0×1.0mm	0804
21	2.0×1.25mm	0805
31	3.2×1.6mm	1206
41	4.5×1.6mm	1806

④ Characteristics/Applications

Code ^{*1}	Characteristics/Applications	Series
AG	For General Use	BLM03/15/18/21, BLA2A/31
AX		BLM02/03/15
TG		BLM18
BA	For High-speed Signal Lines	BLM15/18
BB		BLM03/15/18/21, BLA2A
BC		BLM03/15
BD		BLM03/15/18/21, BLA2A/31
BX		BLM15
PD		BLM15
PG	For Power Lines	BLM03/15/18/21/31/41
PX		BLM03/15
KG	For Power Lines (Low DC Resistance Type)	BLM15
SG		BLM18
RK	For Digital Interface	BLM18/21
HG	For GHz Band General Use	BLM03/15/18
EB	For GHz Band High-speed Signal Lines (Low Direct Current Type)	BLM03
EG	For GHz Band General Use (Low DC Resistance Type)	BLM15/18
HB	For GHz Band High-speed Signal Lines	BLM03/15/18
HD		BLM03/15/18
HE		BLM18
HK	For GHz Band Digital Interface	BLM18
GA	For High-GHz Band High-speed Signal Lines	BLM15
GG	For High-GHz Band General Use	BLM15/18

^{*1} Frequency characteristics vary with each code.

⑨ Packaging

Code	Packaging	Series
K	Embossed Taping (ø330mm Reel)	BLM21 ^{*1} /31/41
L	Embossed Taping (ø180mm Reel)	
B	Bulk	All Series
J	Paper Taping (ø330mm Reel)	BLM03/15/18 ^{*3} /21 ^{*2} , BLA2A/31
D	Paper Taping (ø180mm Reel)	BLM02/03/15/18/21 ^{*2} , BLA2A/31

^{*1} BLM21BD222SN1/BLM21BD272SN1 only. ^{*2} Except for BLM21BD222SN1/BLM21BD272SN1 ^{*3} Except for BLM18T

⑤ Impedance

Expressed by three figures. The unit is in ohm (Ω) at 100MHz. The first and second figures are significant digits, and the third figure expresses the number of zeros that follow the two figures.

⑥ Electrode

Expressed by a letter.

Ex.)	Code	Electrode
	S/T	Sn Plating
	A	Au Plating

⑦ Category

Code	Category
N	Standard Type

⑧ Number of Circuits

Code	Number of Circuits
1	1 Circuit
4	4 Circuits

[△]Note • Please read rating and [△]CAUTION (for storage, operating, rating, soldering, mounting and handling) in this catalog to prevent smoking and/or burning, etc.
• This catalog has only typical specifications. Therefore, please approve our product specifications or transact the approval sheet for product specifications before ordering.

BL Chip Ferrite Bead Series Line Up

Size Code (Inch)	Thickness (mm)	Type	Part Number	Impedance		Rated Current	New	Kit	≥1A	GHz	Flow	RefFlow		
				at 100MHz/20°C	at 1GHz/20°C									
01005	0.2	Universal Type [Power lines/Signal lines]	p23 BLM02AX100SN1	10ohm±5ohm	-	750mA						RefFlow		
			BLM02AX700SN1	70ohm±25%	-	300mA						RefFlow		
			BLM02AX121SN1	120ohm±25%	-	250mA						RefFlow		
	0.3	For General Signal Lines	p30 BLM03AG100SN1	10ohm(Typ.)	-	500mA	Kit					RefFlow		
			BLM03AG700SN1	70ohm(Typ.)	-	200mA	Kit					RefFlow		
			BLM03AG800SN1	80ohm±25%	-	200mA	Kit					RefFlow		
			BLM03AG121SN1	120ohm±25%	-	200mA	Kit					RefFlow		
			BLM03AG241SN1	240ohm±25%	-	200mA	Kit					RefFlow		
			BLM03AG601SN1	600ohm±25%	-	100mA	Kit					RefFlow		
			BLM03AG102SN1	1000ohm±25%	-	100mA	Kit					RefFlow		
			0.3	Universal Type [Power lines/Signal lines]	p28 BLM03AX100SN1	10ohm(Typ.)	-	1000mA	Kit	≥1A				RefFlow
	BLM03AX800SN1	80ohm±25%			-	500mA	Kit					RefFlow		
	BLM03AX121SN1	120ohm±25%			-	450mA	Kit					RefFlow		
	BLM03AX241SN1	240ohm±25%			-	350mA	Kit					RefFlow		
	BLM03AX601SN1	600ohm±25%			-	250mA	Kit					RefFlow		
BLM03AX102SN1	1000ohm±25%	-			200mA	Kit					RefFlow			
0201	0.3	For High Speed Signal Lines (Sharp Impedance Curve)	p32 BLM03BD750SN1	75ohm±25%	-	300mA	Kit					RefFlow		
			BLM03BD121SN1	120ohm±25%	-	250mA	Kit					RefFlow		
			BLM03BD241SN1	240ohm±25%	-	200mA	Kit					RefFlow		
			BLM03BD471SN1	470ohm±25%	-	215mA	Kit					RefFlow		
			BLM03BD601SN1	600ohm±25%	-	200mA	Kit					RefFlow		
			BLM03BB100SN1	10ohm±25%	-	300mA	Kit					RefFlow		
			BLM03BB220SN1	22ohm±25%	-	200mA	Kit					RefFlow		
			BLM03BB470SN1	47ohm±25%	-	200mA	Kit					RefFlow		
			BLM03BB750SN1	75ohm±25%	-	200mA	Kit					RefFlow		
			BLM03BB121SN1	120ohm±25%	-	100mA	Kit					RefFlow		
			BLM03BC330SN1	33ohm±25%	-	150mA	Kit					RefFlow		
			BLM03BC560SN1	56ohm±25%	-	100mA	Kit					RefFlow		
			BLM03BC800SN1	80ohm±25%	-	100mA	Kit					RefFlow		
			0.3	For Power Lines	p25 BLM03PG220SN1	22ohm±25%	-	900mA	Kit					RefFlow
					BLM03PG330SN1	33ohm±25%	-	750mA	Kit					RefFlow
	p26 BLM03PX220SN1	22ohm±25%			-	1800mA	Kit	≥1A				RefFlow		
	BLM03PX330SN1	33ohm±25%			-	1500mA	Kit	≥1A				RefFlow		
	BLM03PX800SN1	80ohm±25%			-	1000mA	Kit	≥1A				RefFlow		
	0.3	For GHz Band Noise	For General Signal Lines	p82 BLM03HG601SN1	600ohm±25%	1000ohm±40%	150mA	Kit		GHz		RefFlow		
				BLM03HG102SN1	1000ohm±25%	1800ohm±40%	125mA	Kit		GHz		RefFlow		
				BLM03EB250SN1	25ohm±25%	105ohm±40%	600mA	New Kit		GHz		RefFlow		
[Power lines/Signal lines]			BLM03EB500SN1	50ohm±25%	255ohm±40%	400mA	New Kit		GHz		RefFlow			
			For High Speed Signal Lines	p82 BLM03HD331SN1	330ohm±25%	-	200mA	Kit		GHz		RefFlow		
				BLM03HD471SN1	470ohm±25%	-	175mA	Kit		GHz		RefFlow		
BLM03HD601SN1				600ohm±25%	-	150mA	Kit		GHz		RefFlow			
BLM03HD102SN1			1000ohm±25%	-	120mA	Kit		GHz		RefFlow				
BLM03HB191SN1			190ohm±25%	1150ohm±40%	150mA	New Kit		GHz		RefFlow				
0402	0.5	For General Signal Lines	p40 BLM15AG100SN1	10ohm(Typ.)	-	1000mA	Kit	≥1A				RefFlow		
			BLM15AG700SN1	70ohm(Typ.)	-	600mA	Kit					RefFlow		
			BLM15AG121SN1	120ohm±25%	-	550mA	Kit					RefFlow		
			BLM15AG221SN1	220ohm±25%	-	450mA	Kit					RefFlow		
			BLM15AG601SN1	600ohm±25%	-	300mA	Kit					RefFlow		
			BLM15AG102SN1	1000ohm±25%	-	300mA	Kit					RefFlow		
	0.5	Universal Type [Power lines/Signal lines]	p38 BLM15AX100SN1	10ohm(Typ.)	-	1740mA	Kit	≥1A				RefFlow		
			BLM15AX300SN1	30ohm±25%	-	1100mA	Kit	≥1A				RefFlow		
			BLM15AX700SN1	70ohm±25%	-	780mA	Kit					RefFlow		
			BLM15AX121SN1	120ohm±25%	-	700mA	Kit					RefFlow		
			BLM15AX221SN1	220ohm±25%	-	600mA	Kit					RefFlow		
			BLM15AX601SN1	600ohm±25%	-	500mA	Kit					RefFlow		
			BLM15AX102SN1	1000ohm±25%	-	350mA	Kit					RefFlow		

Continued on the following page.

△Note • Please read rating and △CAUTION (for storage, operating, rating, soldering, mounting and handling) in this catalog to prevent smoking and/or burning, etc.
• This catalog has only typical specifications. Therefore, please approve our product specifications or transact the approval sheet for product specifications before ordering.

Size Code (Inch)	Thickness (mm)	Type	Part Number	Impedance		Rated Current	New	Kit	≥1A	GHz	Flow	RefLow		
				at 100MHz/20°C	at 1GHz/20°C									
0402	0.5	For High Speed Signal Lines (Sharp Impedance Curve)	p42	BLM15BX750SN1	75ohm±25%	-	600mA	New	Kit			RefLow		
	0.5			BLM15BX121SN1	120ohm±25%	-	600mA	New	Kit			RefLow		
	0.5			BLM15BX221SN1	220ohm±25%	-	450mA	New	Kit			RefLow		
	0.5			BLM15BX471SN1	470ohm±25%	-	350mA	New	Kit			RefLow		
	0.5			BLM15BX601SN1	600ohm±25%	-	350mA	New	Kit			RefLow		
	0.5			BLM15BX102SN1	1000ohm±25%	-	300mA	New	Kit			RefLow		
	0.5			BLM15BX182SN1	1800ohm±25%	-	250mA	New	Kit			RefLow		
	0.5		p44	BLM15BD750SN1	75ohm±25%	-	300mA		Kit			RefLow		
	0.5			BLM15BD121SN1	120ohm±25%	-	300mA		Kit			RefLow		
	0.5			BLM15BD221SN1	220ohm±25%	-	300mA		Kit			RefLow		
	0.5			BLM15BD471SN1	470ohm±25%	-	200mA		Kit			RefLow		
	0.5			BLM15BD601SN1	600ohm±25%	-	200mA		Kit			RefLow		
	0.5			BLM15BD102SN1	1000ohm±25%	-	200mA		Kit			RefLow		
	0.5			BLM15BD182SN1	1800ohm±25%	-	100mA		Kit			RefLow		
	0.5		BLM15BB050SN1	5ohm±25%	-	500mA		Kit			RefLow			
	0.5		BLM15BB100SN1	10ohm±25%	-	300mA		Kit			RefLow			
	0.5		BLM15BB220SN1	22ohm±25%	-	300mA		Kit			RefLow			
	0.5		BLM15BB470SN1	47ohm±25%	-	300mA		Kit			RefLow			
	0.5		BLM15BB750SN1	75ohm±25%	-	300mA		Kit			RefLow			
	0.5		BLM15BB121SN1	120ohm±25%	-	300mA		Kit			RefLow			
	0.5		BLM15BB221SN1	220ohm±25%	-	200mA		Kit			RefLow			
	0.5		BLM15BC121SN1	120ohm±25%	-	350mA		Kit			RefLow			
	0.5		BLM15BC241SN1	240ohm±25%	-	250mA		Kit			RefLow			
	0.5		BLM15BA050SN1	5ohm±25%	-	300mA		Kit			RefLow			
	0.5		BLM15BA100SN1	10ohm±25%	-	300mA		Kit			RefLow			
	0.5		BLM15BA220SN1	22ohm±25%	-	300mA		Kit			RefLow			
	0.5		BLM15BA330SN1	33ohm±25%	-	300mA		Kit			RefLow			
	0.5		BLM15BA470SN1	47ohm±25%	-	200mA		Kit			RefLow			
	0.5		BLM15BA750SN1	75ohm±25%	-	200mA		Kit			RefLow			
	0.5		For Power Lines	p34	BLM15PX330SN1	33ohm±25%	-	3000mA	New	Kit	≥3A			RefLow
	0.5				BLM15PX600SN1	60ohm±25%	-	2500mA	New	Kit	≥1A			RefLow
	0.5				BLM15PX800SN1	80ohm±25%	-	2300mA	New	Kit	≥1A			RefLow
	0.5				BLM15PX121SN1	120ohm±25%	-	2000mA	New	Kit	≥1A			RefLow
	0.5				BLM15PX181SN1	180ohm±25%	-	1500mA	New	Kit	≥1A			RefLow
	0.5				BLM15PX221SN1	220ohm±25%	-	1400mA	New	Kit	≥1A			RefLow
	0.5				BLM15PX331SN1	330ohm±25%	-	1200mA	New	Kit	≥1A			RefLow
	0.5			BLM15PX471SN1	470ohm±25%	-	1000mA	New	Kit	≥1A			RefLow	
	0.5			BLM15PX601SN1	600ohm±25%	-	900mA	New	Kit				RefLow	
	0.5			p36	BLM15PG100SN1	10ohm(Typ.)	-	1000mA		Kit	≥1A			RefLow
	0.5				BLM15PD300SN1	30ohm±25%	-	2200mA		Kit	≥1A			RefLow
0.5	BLM15PD600SN1	60ohm±25%			-	1700mA		Kit	≥1A			RefLow		
0.5	BLM15PD800SN1	80ohm±25%			-	1500mA		Kit	≥1A			RefLow		
0.5	BLM15PD121SN1	120ohm±25%	-		1300mA		Kit	≥1A			RefLow			
0.5	For GHz Band Noise	p85	BLM15HG601SN1		600ohm±25%	1000ohm±40%	300mA		Kit		GHz		RefLow	
0.5			BLM15HG102SN1	1000ohm±25%	1400ohm±40%	250mA		Kit			GHz		RefLow	
0.5			BLM15HD601SN1	600ohm±25%	1400ohm±40%	300mA		Kit			GHz		RefLow	
0.5		For High Speed Signal Lines (Sharp Impedance Curve)	p85	BLM15HD102SN1	1000ohm±25%	2000ohm±40%	250mA		Kit		GHz		RefLow	
0.5				BLM15HD182SN1	1800ohm±25%	2700ohm±40%	200mA		Kit			GHz		RefLow
0.5				BLM15HB121SN1	120ohm±25%	500ohm±40%	300mA		Kit			GHz		RefLow
0.5				BLM15HB221SN1	220ohm±25%	900ohm±40%	250mA		Kit			GHz		RefLow
0.5	Universal Type [Power Lines/Signal Lines]	p87	BLM15EG121SN1	120ohm±25%	145ohm(Typ.)	1500mA		Kit	≥1A		GHz		RefLow	
0.5			BLM15EG221SN1	220ohm±25%	270ohm(Typ.)	700mA		Kit			GHz		RefLow	
0.5	For High-GHz Band Noise	p88	BLM15GG221SN1	220ohm±25%	600ohm±40%	300mA		Kit			Hi-GHz		RefLow	
0.5			BLM15GG471SN1	470ohm±25%	1200ohm±40%	200mA		Kit			Hi-GHz		RefLow	
0.5			For High Speed Signal Lines p88	BLM15GA750SN1	75ohm±25%	1000ohm±40%	200mA		Kit			Hi-GHz		RefLow

Continued on the following page. ↗

△Note • Please read rating and △CAUTION (for storage, operating, rating, soldering, mounting and handling) in this catalog to prevent smoking and/or burning, etc.
 • This catalog has only typical specifications. Therefore, please approve our product specifications or transact the approval sheet for product specifications before ordering.

Chip Ferrite Bead
Chip EMIFIL®
Chip Common Mode Choke Coil
Block Type EMIFIL®
Microwave Absorber

Size Code (Inch)	Thickness (mm)	Type	Part Number	Impedance		Rated Current	New	Kit	≥1A ≥3A	GHz Hz	Flow	Reflow	
				at 100MHz/20°C	at 1GHz/20°C								
0603	0.8	For General Signal Lines	p54 BLM18AG121SN1	120ohm±25%	-	500mA		Kit			Flow	Reflow	
	0.8		BLM18AG151SN1	150ohm±25%	-	500mA		Kit			Flow	Reflow	
	0.8		BLM18AG221SN1	220ohm±25%	-	500mA		Kit			Flow	Reflow	
	0.8		BLM18AG331SN1	330ohm±25%	-	500mA		Kit			Flow	Reflow	
	0.8		BLM18AG471SN1	470ohm±25%	-	500mA		Kit			Flow	Reflow	
	0.8		BLM18AG601SN1	600ohm±25%	-	500mA		Kit			Flow	Reflow	
	0.8		BLM18AG102SN1	1000ohm±25%	-	400mA		Kit			Flow	Reflow	
	0.6		p60 BLM18TG121TN1	120ohm±25%	-	200mA						Flow	Reflow
	0.6		BLM18TG221TN1	220ohm±25%	-	200mA						Flow	Reflow
	0.6		BLM18TG601TN1	600ohm±25%	-	200mA						Flow	Reflow
	0.6	BLM18TG102TN1	1000ohm±25%	-	100mA						Flow	Reflow	
	0.8	For High Speed Signal Lines (Sharp Impedance Curve)	p56 BLM18BD470SN1	47ohm±25%	-	500mA		Kit			Flow	Reflow	
	0.8		BLM18BD121SN1	120ohm±25%	-	200mA		Kit			Flow	Reflow	
	0.8		BLM18BD151SN1	150ohm±25%	-	200mA		Kit			Flow	Reflow	
	0.8		BLM18BD221SN1	220ohm±25%	-	200mA		Kit			Flow	Reflow	
	0.8		BLM18BD331SN1	330ohm±25%	-	200mA		Kit			Flow	Reflow	
	0.8		BLM18BD421SN1	420ohm±25%	-	200mA		Kit			Flow	Reflow	
	0.8		BLM18BD471SN1	470ohm±25%	-	200mA		Kit			Flow	Reflow	
	0.8		BLM18BD601SN1	600ohm±25%	-	200mA		Kit			Flow	Reflow	
	0.8		BLM18BD102SN1	1000ohm±25%	-	100mA		Kit			Flow	Reflow	
	0.8		BLM18BD152SN1	1500ohm±25%	-	50mA		Kit			Flow	Reflow	
	0.8		BLM18BD182SN1	1800ohm±25%	-	50mA		Kit			Flow	Reflow	
	0.8		BLM18BD222SN1	2200ohm±25%	-	50mA		Kit			Flow	Reflow	
	0.8		BLM18BD252SN1	2500ohm±25%	-	50mA		Kit			Flow	Reflow	
	0.8		BLM18BB050SN1	5ohm±25%	-	700mA		Kit			Flow	Reflow	
	0.8		BLM18BB100SN1	10ohm±25%	-	700mA		Kit			Flow	Reflow	
	0.8		BLM18BB220SN1	22ohm±25%	-	600mA		Kit			Flow	Reflow	
	0.8		BLM18BB470SN1	47ohm±25%	-	550mA		Kit			Flow	Reflow	
	0.8		BLM18BB600SN1	60ohm±25%	-	550mA		Kit			Flow	Reflow	
	0.8		BLM18BB750SN1	75ohm±25%	-	500mA		Kit			Flow	Reflow	
	0.8		BLM18BB121SN1	120ohm±25%	-	500mA		Kit			Flow	Reflow	
	0.8		BLM18BB141SN1	140ohm±25%	-	450mA					Flow	Reflow	
	0.8		BLM18BB151SN1	150ohm±25%	-	450mA		Kit			Flow	Reflow	
	0.8		BLM18BB221SN1	220ohm±25%	-	450mA		Kit			Flow	Reflow	
	0.8		BLM18BB331SN1	330ohm±25%	-	400mA		Kit			Flow	Reflow	
	0.8		BLM18BB471SN1	470ohm±25%	-	300mA		Kit			Flow	Reflow	
	0.8		BLM18BA050SN1	5ohm±25%	-	500mA		Kit			Flow	Reflow	
	0.8		BLM18BA100SN1	10ohm±25%	-	500mA		Kit			Flow	Reflow	
	0.8		BLM18BA220SN1	22ohm±25%	-	500mA					Flow	Reflow	
	0.8		BLM18BA470SN1	47ohm±25%	-	300mA		Kit			Flow	Reflow	
	0.8		BLM18BA750SN1	75ohm±25%	-	300mA		Kit			Flow	Reflow	
	0.8	BLM18BA121SN1	120ohm±25%	-	200mA		Kit			Flow	Reflow		
	0.8	For Digital Interface Lines	p61 BLM18RK121SN1	120ohm±25%	-	200mA		Kit			Flow	Reflow	
	0.8		BLM18RK221SN1	220ohm±25%	-	200mA					Flow	Reflow	
	0.8		BLM18RK471SN1	470ohm±25%	-	200mA		Kit			Flow	Reflow	
0.8	BLM18RK601SN1		600ohm±25%	-	200mA		Kit			Flow	Reflow		
0.8	BLM18RK102SN1		1000ohm±25%	-	200mA		Kit			Flow	Reflow		

Continued on the following page. ↗

△Note • Please read rating and △CAUTION (for storage, operating, rating, soldering, mounting and handling) in this catalog to prevent smoking and/or burning, etc.
• This catalog has only typical specifications. Therefore, please approve our product specifications or transact the approval sheet for product specifications before ordering.

Size Code (Inch)	Thickness (mm)	Type	Part Number	Impedance		Rated Current	New	Kit	≥1A	GHz	F _{low}	R _{eflow}	
				at 100MHz/20°C	at 1GHz/20°C								
0603	0.8	Standard Type	p48 BLM18PG300SN1	30ohm(Typ.)	-	1000mA	Kit	≥1A			F _{low}	R _{eflow}	
	0.8		BLM18PG330SN1	33ohm±25%	-	3000mA	Kit	≥3A			F _{low}	R _{eflow}	
	0.8		BLM18PG600SN1	60ohm(Typ.)	-	500mA	Kit				F _{low}	R _{eflow}	
	0.8		BLM18PG121SN1	120ohm±25%	-	2000mA	Kit	≥1A			F _{low}	R _{eflow}	
	0.8		BLM18PG181SN1	180ohm±25%	-	1500mA	Kit	≥1A			F _{low}	R _{eflow}	
	0.8		BLM18PG221SN1	220ohm±25%	-	1400mA	Kit	≥1A			F _{low}	R _{eflow}	
	0.8		BLM18PG331SN1	330ohm±25%	-	1200mA	Kit	≥1A			F _{low}	R _{eflow}	
	0.8		BLM18PG471SN1	470ohm±25%	-	1000mA	Kit	≥1A			F _{low}	R _{eflow}	
	0.6	For Power Lines	p50 BLM18KG260TN1	26ohm±25%	-	6000mA	Kit	≥3A			F _{low}	R _{eflow}	
	0.6		BLM18KG300TN1	30ohm±25%	-	5000mA	Kit	≥3A			F _{low}	R _{eflow}	
	0.6		BLM18KG700TN1	70ohm±25%	-	3500mA	Kit	≥3A			F _{low}	R _{eflow}	
	0.6		BLM18KG101TN1	100ohm±25%	-	3000mA	Kit	≥3A			F _{low}	R _{eflow}	
	0.6		BLM18KG121TN1	120ohm±25%	-	3000mA	Kit	≥3A			F _{low}	R _{eflow}	
	0.8		BLM18KG221SN1	220ohm±25%	-	2200mA	Kit	≥1A			F _{low}	R _{eflow}	
	0.8		BLM18KG331SN1	330ohm±25%	-	1700mA	Kit	≥1A			F _{low}	R _{eflow}	
	0.8		BLM18KG471SN1	470ohm±25%	-	1500mA	Kit	≥1A			F _{low}	R _{eflow}	
	0.8	Low DC Resistance Type	BLM18KG601SN1	600ohm±25%	-	1300mA	Kit	≥1A			F _{low}	R _{eflow}	
	0.5		p52	BLM18SG260TN1	26ohm±25%	-	6000mA	Kit	≥3A			F _{low}	R _{eflow}
	0.5			BLM18SG700TN1	70ohm±25%	-	4000mA	Kit	≥3A			F _{low}	R _{eflow}
	0.5			BLM18SG121TN1	120ohm±25%	-	3000mA	Kit	≥3A			F _{low}	R _{eflow}
	0.5	BLM18SG221TN1		220ohm±25%	-	2500mA	Kit	≥1A			F _{low}	R _{eflow}	
	0.5		BLM18SG331TN1	330ohm±25%	-	1500mA	Kit	≥1A			F _{low}	R _{eflow}	
	0.8	For GHz Band Noise	p89 For General Signal Lines	BLM18HG471SN1	470ohm±25%	600ohm(Typ.)	200mA	Kit		GHz	F _{low}	R _{eflow}	
	0.8			BLM18HG601SN1	600ohm±25%	700ohm(Typ.)	200mA	Kit		GHz	F _{low}	R _{eflow}	
	0.8			BLM18HG102SN1	1000ohm±25%	1000ohm(Typ.)	100mA	Kit		GHz	F _{low}	R _{eflow}	
	0.8			BLM18HE601SN1	600ohm±25%	600ohm(Typ.)	800mA	Kit		GHz	F _{low}	R _{eflow}	
	0.8		For High Speed Signal Lines (Sharp Impedance Curve)	p89 BLM18HE102SN1	1000ohm±25%	1000ohm(Typ.)	600mA	Kit		GHz	F _{low}	R _{eflow}	
	0.8			BLM18HE152SN1	1500ohm±25%	1500ohm(Typ.)	500mA	Kit		GHz	F _{low}	R _{eflow}	
	0.8			BLM18HD471SN1	470ohm±25%	1000ohm(Typ.)	100mA	Kit		GHz	F _{low}	R _{eflow}	
	0.8			BLM18HD601SN1	600ohm±25%	1200ohm(Typ.)	100mA	Kit		GHz	F _{low}	R _{eflow}	
	0.8			BLM18HD102SN1	1000ohm±25%	1700ohm(Typ.)	50mA	Kit		GHz	F _{low}	R _{eflow}	
	0.8			BLM18HB121SN1	120ohm±25%	500ohm±40%	200mA	Kit		GHz	F _{low}	R _{eflow}	
	0.8			BLM18HB221SN1	220ohm±25%	1100ohm±40%	100mA	Kit		GHz	F _{low}	R _{eflow}	
	0.8			BLM18HB331SN1	330ohm±25%	1600ohm±40%	50mA	Kit		GHz	F _{low}	R _{eflow}	
	0.8		For Digital Interface Lines	p89 BLM18HK331SN1	330ohm±25%	400ohm±40%	200mA	Kit		GHz	F _{low}	R _{eflow}	
	0.8			BLM18HK471SN1	470ohm±25%	600ohm±40%	200mA	Kit		GHz	F _{low}	R _{eflow}	
	0.8			BLM18HK601SN1	600ohm±25%	700ohm±40%	100mA	Kit		GHz	F _{low}	R _{eflow}	
	0.8			BLM18HK102SN1	1000ohm±25%	1200ohm±40%	50mA	Kit		GHz	F _{low}	R _{eflow}	
	0.5	Universal Type [Power lines/Signal lines]	p93	BLM18EG101TN1	100ohm±25%	140ohm(Typ.)	2000mA	Kit	≥1A	GHz	F _{low}	R _{eflow}	
	0.8			BLM18EG121SN1	120ohm±25%	145ohm(Typ.)	2000mA	Kit	≥1A	GHz	F _{low}	R _{eflow}	
0.8	BLM18EG221SN1			220ohm±25%	260ohm(Typ.)	2000mA	Kit	≥1A	GHz	F _{low}	R _{eflow}		
0.5	BLM18EG221TN1			220ohm±25%	300ohm(Typ.)	1000mA	Kit	≥1A	GHz	F _{low}	R _{eflow}		
0.5	BLM18EG331TN1			330ohm±25%	450ohm(Typ.)	500mA	Kit		GHz	F _{low}	R _{eflow}		
0.5	BLM18EG391TN1			390ohm±25%	520ohm(Typ.)	500mA	Kit		GHz	F _{low}	R _{eflow}		
0.8	BLM18EG471SN1			470ohm±25%	550ohm(Typ.)	500mA	Kit		GHz	F _{low}	R _{eflow}		
0.8	BLM18EG601SN1			600ohm±25%	700ohm(Typ.)	500mA	Kit		GHz	F _{low}	R _{eflow}		
0.8	For High-GHz Band Noise	p95 BLM18GG471SN1	470ohm±25%	1800ohm±30%	200mA	Kit		H _{GHz}		R _{eflow}			
0805	0.85	For General Signal Lines	p66 BLM21AG121SN1	120ohm±25%	-	800mA	Kit			F _{low}	R _{eflow}		
	0.85		BLM21AG151SN1	150ohm±25%	-	800mA	Kit			F _{low}	R _{eflow}		
	0.85		BLM21AG221SN1	220ohm±25%	-	800mA	Kit			F _{low}	R _{eflow}		
	0.85		BLM21AG331SN1	330ohm±25%	-	700mA	Kit			F _{low}	R _{eflow}		
	0.85		BLM21AG471SN1	470ohm±25%	-	700mA	Kit			F _{low}	R _{eflow}		
	0.85		BLM21AG601SN1	600ohm±25%	-	600mA	Kit			F _{low}	R _{eflow}		
	0.85		BLM21AG102SN1	1000ohm±25%	-	500mA	Kit			F _{low}	R _{eflow}		

Continued on the following page.

△Note • Please read rating and △CAUTION (for storage, operating, rating, soldering, mounting and handling) in this catalog to prevent smoking and/or burning, etc.
 • This catalog has only typical specifications. Therefore, please approve our product specifications or transact the approval sheet for product specifications before ordering.

Chip Ferrite Bead
Chip EMIFIL®
Chip Common Mode Choke Coil
Block Type EMIFIL®
Microwave Absorber

Size Code (Inch)	Thickness (mm)	Type	Part Number	Impedance		Rated Current	New	Kit	≥1A	GHz	F _{low}	R _{eflow}	
				at 100MHz/20°C	at 1GHz/20°C								
0805	0.85	For High Speed Signal Lines (Sharp Impedance Curve)	p68 BLM21BD121SN1	120ohm±25%	-	200mA		Kit			F _{low}	R _{eflow}	
	0.85		BLM21BD151SN1	150ohm±25%	-	200mA					F _{low}	R _{eflow}	
	0.85		BLM21BD221SN1	220ohm±25%	-	200mA		Kit			F _{low}	R _{eflow}	
	0.85		BLM21BD331SN1	330ohm±25%	-	200mA					F _{low}	R _{eflow}	
	0.85		BLM21BD421SN1	420ohm±25%	-	200mA		Kit			F _{low}	R _{eflow}	
	0.85		BLM21BD471SN1	470ohm±25%	-	200mA		Kit			F _{low}	R _{eflow}	
	0.85		BLM21BD601SN1	600ohm±25%	-	200mA		Kit			F _{low}	R _{eflow}	
	0.85		BLM21BD751SN1	750ohm±25%	-	200mA					F _{low}	R _{eflow}	
	0.85		BLM21BD102SN1	1000ohm±25%	-	200mA		Kit			F _{low}	R _{eflow}	
	0.85		BLM21BD152SN1	1500ohm±25%	-	200mA		Kit			F _{low}	R _{eflow}	
	0.85		BLM21BD182SN1	1800ohm±25%	-	200mA		Kit			F _{low}	R _{eflow}	
	0.85		BLM21BD222TN1	2200ohm±25%	-	200mA		Kit			F _{low}	R _{eflow}	
	1.25		BLM21BD222SN1	2250ohm(Typ.)	-	200mA		Kit				F _{low}	R _{eflow}
	1.25		BLM21BD272SN1	2700ohm±25%	-	200mA		Kit				F _{low}	R _{eflow}
	0.85		BLM21BB050SN1	5ohm±25%	-	1000mA		Kit				F _{low}	R _{eflow}
	0.85		BLM21BB600SN1	60ohm±25%	-	800mA		Kit				F _{low}	R _{eflow}
	0.85		BLM21BB750SN1	75ohm±25%	-	700mA		Kit				F _{low}	R _{eflow}
	0.85		BLM21BB121SN1	120ohm±25%	-	600mA		Kit				F _{low}	R _{eflow}
	0.85		BLM21BB151SN1	150ohm±25%	-	600mA						F _{low}	R _{eflow}
	0.85		BLM21BB201SN1	200ohm±25%	-	500mA						F _{low}	R _{eflow}
0.85	BLM21BB221SN1	220ohm±25%	-	500mA		Kit				F _{low}	R _{eflow}		
0.85	BLM21BB331SN1	330ohm±25%	-	400mA		Kit				F _{low}	R _{eflow}		
0.85	BLM21BB471SN1	470ohm±25%	-	400mA		Kit				F _{low}	R _{eflow}		
0.85	For Digital Interface Lines	p71 BLM21RK121SN1	120ohm±25%	-	200mA					F _{low}	R _{eflow}		
0.85		BLM21RK221SN1	220ohm±25%	-	200mA					F _{low}	R _{eflow}		
0.85		BLM21RK471SN1	470ohm±25%	-	200mA					F _{low}	R _{eflow}		
0.85		BLM21RK601SN1	600ohm±25%	-	200mA					F _{low}	R _{eflow}		
0.85		BLM21RK102SN1	1000ohm±25%	-	200mA					F _{low}	R _{eflow}		
0.85	For Power Lines	p64 BLM21PG220SN1	22ohm±25%	-	6000mA		Kit	≥3A		F _{low}	R _{eflow}		
0.85		BLM21PG300SN1	30ohm(Typ.)	-	4000mA		Kit	≥3A		F _{low}	R _{eflow}		
0.85		BLM21PG600SN1	60ohm±25%	-	3500mA		Kit	≥3A		F _{low}	R _{eflow}		
0.85		BLM21PG121SN1	120ohm±25%	-	3000mA		Kit	≥3A		F _{low}	R _{eflow}		
0.85		BLM21PG221SN1	220ohm±25%	-	2000mA		Kit	≥1A		F _{low}	R _{eflow}		
0.85		BLM21PG331SN1	330ohm±25%	-	1500mA		Kit	≥1A		F _{low}	R _{eflow}		
1.206	For Power Lines	p73 BLM31PG330SN1	33ohm±25%	-	6000mA		Kit	≥3A		F _{low}	R _{eflow}		
1.1		BLM31PG500SN1	50ohm(Typ.)	-	3500mA		Kit	≥3A		F _{low}	R _{eflow}		
1.1		BLM31PG121SN1	120ohm±25%	-	3500mA		Kit	≥3A		F _{low}	R _{eflow}		
1.1		BLM31PG391SN1	390ohm±25%	-	2000mA		Kit	≥1A		F _{low}	R _{eflow}		
1.1	BLM31PG601SN1	600ohm±25%	-	1500mA		Kit	≥1A		F _{low}	R _{eflow}			
1.806	For Power Lines	p75 BLM41PG600SN1	60ohm(Typ.)	-	6000mA		Kit	≥3A		F _{low}	R _{eflow}		
1.6		BLM41PG750SN1	75ohm(Typ.)	-	3500mA		Kit	≥3A		F _{low}	R _{eflow}		
1.6		BLM41PG181SN1	180ohm±25%	-	3500mA		Kit	≥3A		F _{low}	R _{eflow}		
1.6		BLM41PG471SN1	470ohm±25%	-	2000mA		Kit	≥1A		F _{low}	R _{eflow}		
1.6	BLM41PG102SN1	1000ohm±25%	-	1500mA		Kit	≥1A		F _{low}	R _{eflow}			
0.804	For General Signal Lines	p77 BLA2AAG121SN4	120ohm±25%	-	100mA						R _{eflow}		
0.5		BLA2AAG221SN4	220ohm±25%	-	50mA						R _{eflow}		
0.5		BLA2AAG601SN4	600ohm±25%	-	50mA						R _{eflow}		
0.5		BLA2AAG102SN4	1000ohm±25%	-	50mA						R _{eflow}		
0.5		For High Speed Signal Lines	p77 BLA2ABD750SN4	75ohm±25%	-	200mA						R _{eflow}	
0.5			BLA2ABD121SN4	120ohm±25%	-	200mA						R _{eflow}	
0.5			BLA2ABD221SN4	220ohm±25%	-	100mA						R _{eflow}	
0.5			BLA2ABD471SN4	470ohm±25%	-	100mA						R _{eflow}	
0.5			BLA2ABD601SN4	600ohm±25%	-	100mA						R _{eflow}	
0.5			BLA2ABD102SN4	1000ohm±25%	-	50mA						R _{eflow}	
0.5			BLA2ABB100SN4	10ohm±25%	-	200mA						R _{eflow}	
0.5			BLA2ABB220SN4	22ohm±25%	-	200mA						R _{eflow}	
0.5	BLA2ABB470SN4	47ohm±25%	-	200mA						R _{eflow}			
0.5	BLA2ABB121SN4	120ohm±25%	-	50mA						R _{eflow}			
0.5	BLA2ABB221SN4	220ohm±25%	-	50mA						R _{eflow}			

Continued on the following page.

⚠Note • Please read rating and ⚠CAUTION (for storage, operating, rating, soldering, mounting and handling) in this catalog to prevent smoking and/or burning, etc.
• This catalog has only typical specifications. Therefore, please approve our product specifications or transact the approval sheet for product specifications before ordering.

BL□ Chip Ferrite Bead **Series Line Up**

Size Code (Inch)	Thickness (mm)	Type	Part Number	Impedance		Rated Current	New	Kit	≥1A ≥3A	GHz Hi-GHz	Flow	RefFlow
				at 100MHz/20°C	at 1GHz/20°C							
1206	0.8	For General Signal Lines	BLA31AG300SN4	30ohm±25%	-	200mA					Flow	RefFlow
	0.8		BLA31AG600SN4	60ohm±25%	-	200mA					Flow	RefFlow
	0.8		BLA31AG121SN4	120ohm±25%	-	150mA					Flow	RefFlow
	0.8		BLA31AG221SN4	220ohm±25%	-	150mA					Flow	RefFlow
	0.8		BLA31AG601SN4	600ohm±25%	-	100mA					Flow	RefFlow
	0.8		BLA31AG102SN4	1000ohm±25%	-	50mA					Flow	RefFlow
	0.8	For High Speed Signal Lines	BLA31BD121SN4	120ohm±25%	-	150mA					Flow	RefFlow
	0.8		BLA31BD221SN4	220ohm±25%	-	150mA					Flow	RefFlow
	0.8		BLA31BD471SN4	470ohm±25%	-	100mA					Flow	RefFlow
	0.8		BLA31BD601SN4	600ohm±25%	-	100mA					Flow	RefFlow
0.8		BLA31BD102SN4	1000ohm±25%	-	50mA					Flow	RefFlow	

Chip Ferrite Bead

Chip EMIFIL®

Chip Common Mode Choke Coil

Block Type EMIFIL®

Microwave Absorber

△Note • Please read rating and △CAUTION (for storage, operating, rating, soldering, mounting and handling) in this catalog to prevent smoking and/or burning, etc.
 • This catalog has only typical specifications. Therefore, please approve our product specifications or transact the approval sheet for product specifications before ordering.

BLM02AX Series (01005 Size)



High spec ferrite bead ultra low dc resistance 0402mm size.



■ Dimensions

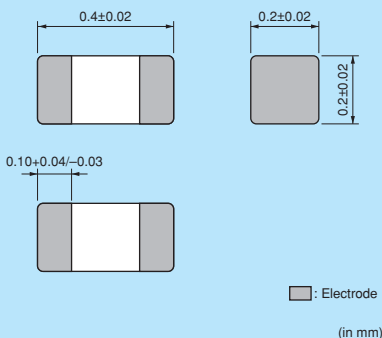

Legend: Electrode (in mm)

■ Equivalent Circuit



(Resistance element becomes dominant at high frequencies.)

■ Packaging

Code	Packaging	Minimum Quantity
D	180mm Reel Paper Tape	20000
B	Bulk(Bag)	1000

Refer to pages from p.97 to p.100 for mounting information.

■ Rated Value (□: packaging code)

Part Number	Impedance (at 100MHz/20°C)	Rated Current	DC Resistance	Operating Temperature Range
BLM02AX100SN1□	10ohm ±5 ohm	750mA	0.07ohm max.	-55°C to +125°C
BLM02AX700SN1□	70ohm ±25%	300mA	0.4ohm max.	-55°C to +125°C
BLM02AX121SN1□	120ohm ±25%	250mA	0.5ohm max.	-55°C to +125°C

Number of Circuits: 1

■ Impedance-Frequency Characteristics

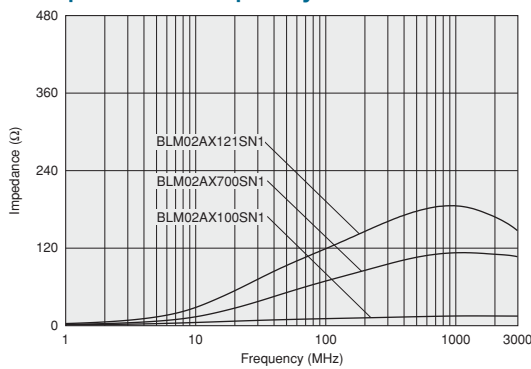

■ Impedance-Frequency Characteristics

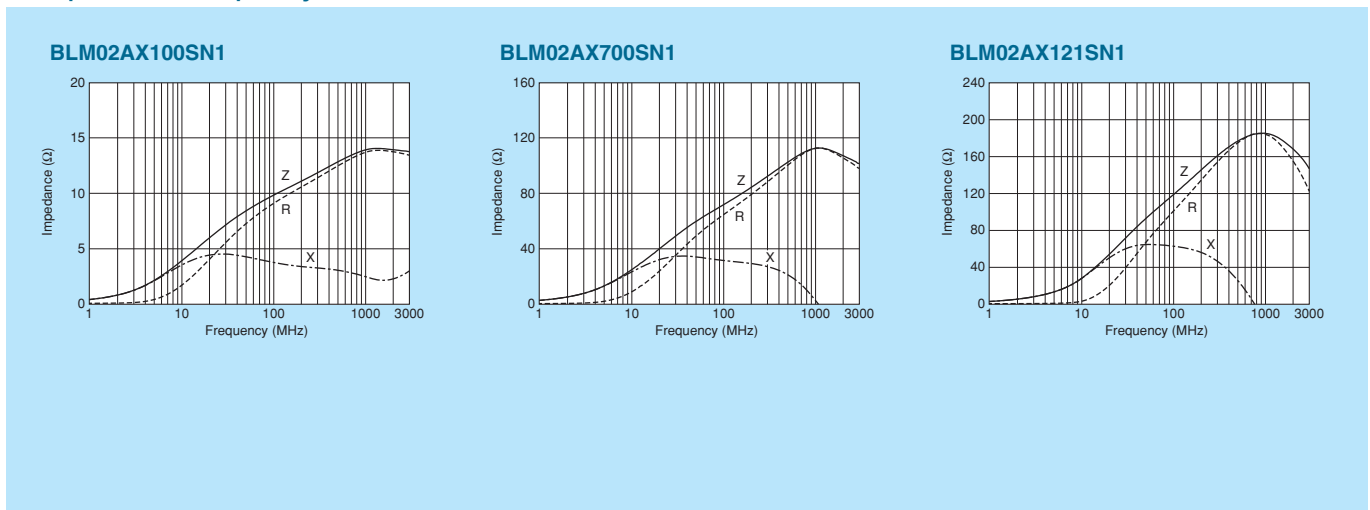

⚠Note • Please read rating and ⚠CAUTION (for storage, operating, rating, soldering, mounting and handling) in this catalog to prevent smoking and/or burning, etc.
 • This catalog has only typical specifications. Therefore, please approve our product specifications or transact the approval sheet for product specifications before ordering.

Excellent for Both Signal and Power Lines.
Multi Function Chip Ferrite Bead BLM□□AX Series

Feature

- 1/2 the DC resistance than conventional type utilizing the latest technology
 - New ferrite material
 - Optimum ferrite firing condition
 - Fine piling technology
 - Advanced coil pattern design technology
- Improved stability of performance at heat shock
- Wide line-up from 10 to 1000ohm(@100MHz) useful for signal line

Advantage

- High Rated Current
 - Good for miniaturization of high power equipment
- Lower Voltage down at Ferrite bead
 - Good for Battery driven equipment by saving running voltage margin
- Higher Reliability

Drastically Reduced DC Resistance

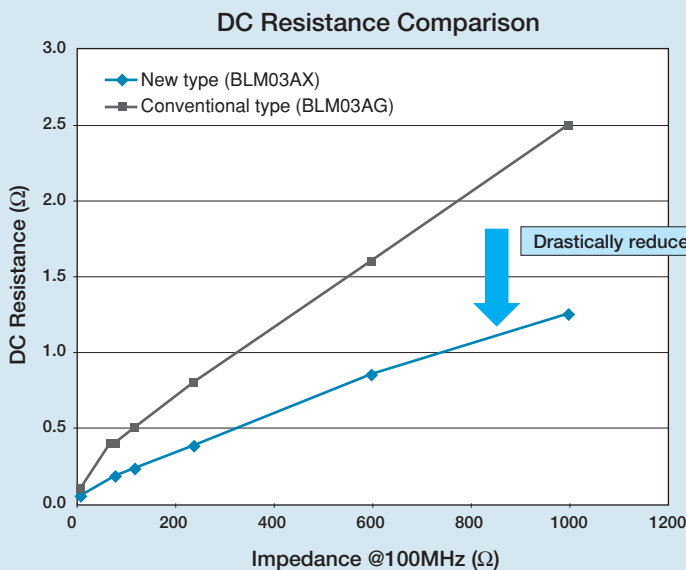

Test Result - Heat Shock

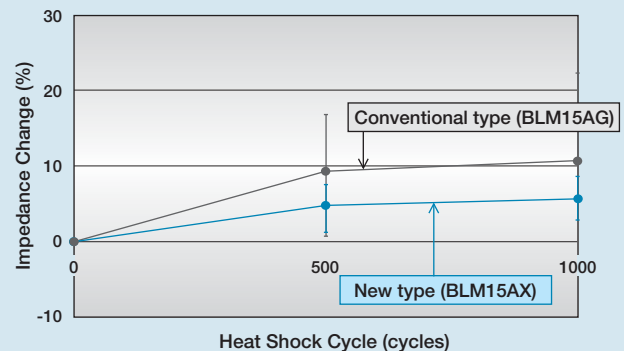

△Note • Please read rating and △CAUTION (for storage, operating, rating, soldering, mounting and handling) in this catalog to prevent smoking and/or burning, etc.
• This catalog has only typical specifications. Therefore, please approve our product specifications or transact the approval sheet for product specifications before ordering.

BLM03PG Series (0201 Size)



0201 size for power lines.

*Please refer to the products designed for both power lines and signal lines.



■ Dimensions

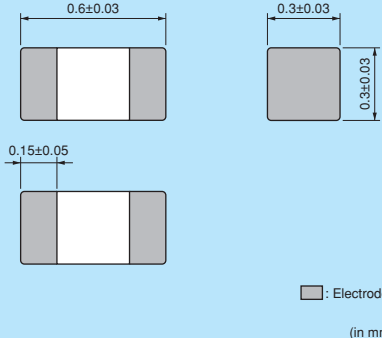

■: Electrode
(in mm)

■ Equivalent Circuit



(Resistance element becomes dominant at high frequencies.)

■ Packaging

Code	Packaging	Minimum Quantity
D	180mm Reel Paper Tape	15000
J	330mm Reel Paper Tape	50000
B	Bulk(Bag)	1000

Refer to pages from p.97 to p.100 for mounting information.

■ Rated Value (□: packaging code)

Part Number	Impedance (at 100MHz/20°C)	Rated Current	DC Resistance	Operating Temperature Range	
BLM03PG220SN1□	22ohm ±25%	900mA	0.065ohm max.	-55°C to +125°C	Kit
BLM03PG330SN1□	33ohm ±25%	750mA	0.090ohm max.	-55°C to +125°C	Kit

Number of Circuits: 1

■ Impedance-Frequency Characteristics

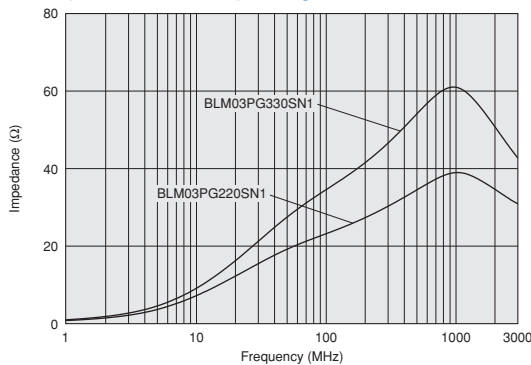

■ Impedance-Frequency Characteristics

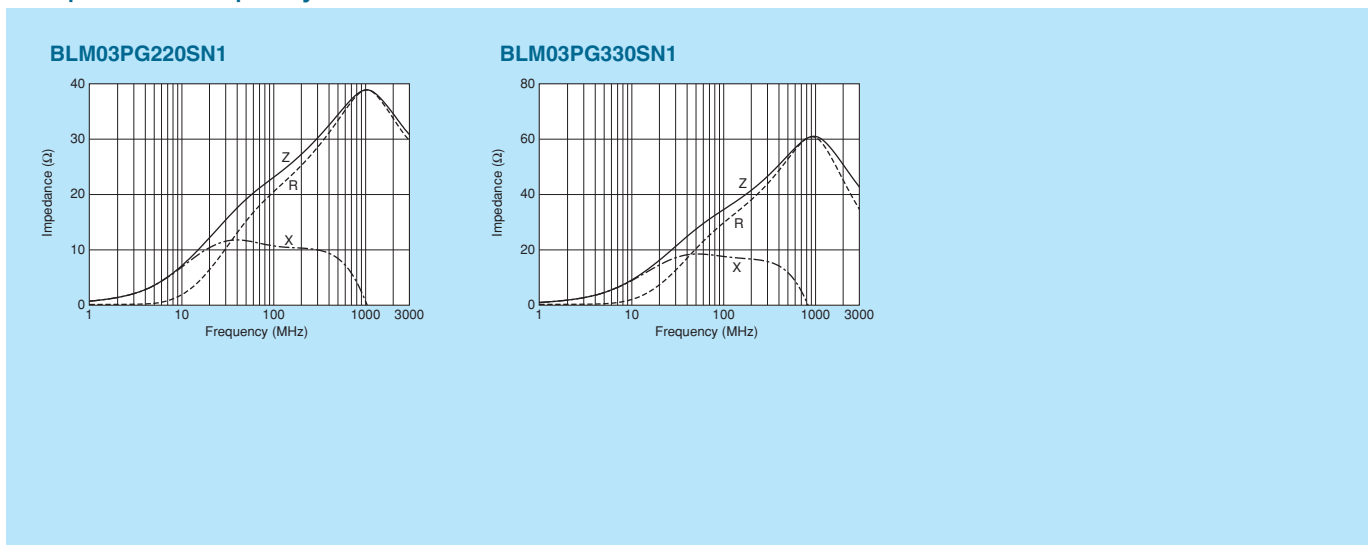

⚠Note • Please read rating and ⚠CAUTION (for storage, operating, rating, soldering, mounting and handling) in this catalog to prevent smoking and/or burning, etc.
• This catalog has only typical specifications. Therefore, please approve our product specifications or transact the approval sheet for product specifications before ordering.

BLM03PX Series (0201 Size)



Improved DC resistance meets larger current.

Chip Ferrite Bead
0201 Size

Chip EMIFIL®

Chip Common Mode Choke Coil

Block Type EMIFIL®

Microwave Absorber

■ Dimensions

(in mm)

■ Equivalent Circuit

(Resistance element becomes dominant at high frequencies.)

■ Packaging

Code	Packaging	Minimum Quantity
D	180mm Reel Paper Tape	15000
J	330mm Reel Paper Tape	50000
B	Bulk(Bag)	1000

Refer to pages from p.97 to p.100 for mounting information.

■ Rated Value (□: packaging code)

Part Number	Impedance (at 100MHz/20°C)	Rated Current	DC Resistance	Operating Temperature Range	
BLM03PX220SN1□	22ohm ±25%	1800mA	0.040ohm max.	-55°C to +125°C	Kit ≥1A
BLM03PX330SN1□	33ohm ±25%	1500mA	0.055ohm max.	-55°C to +125°C	Kit ≥1A
BLM03PX800SN1□	80ohm ±25%	1000mA	0.130ohm max.	-55°C to +125°C	Kit ≥1A

Number of Circuits: 1

■ Impedance-Frequency Characteristics

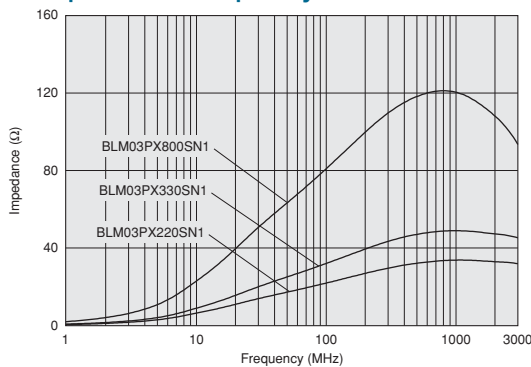

■ Notice (Rating)

In operating temperature exceeding +85°C derating of current is necessary for BLM03PX_SN1 series. Please apply the derating curve shown in chart according to the operating temperature.

Derating of Rated Current

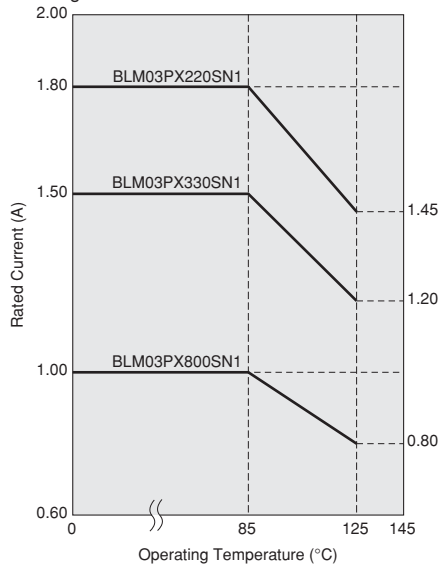

Continued on the following page.

△Note • Please read rating and △CAUTION (for storage, operating, rating, soldering, mounting and handling) in this catalog to prevent smoking and/or burning, etc.
• This catalog has only typical specifications. Therefore, please approve our product specifications or transact the approval sheet for product specifications before ordering.

Impedance-Frequency Characteristics

BLM03PX220SN1

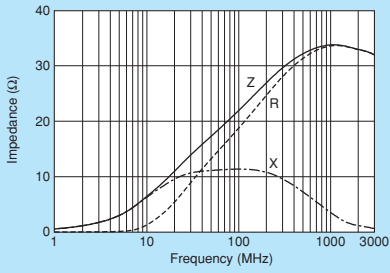

BLM03PX330SN1

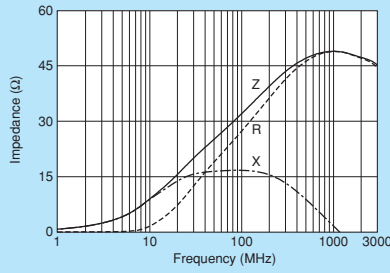

BLM03PX800SN1

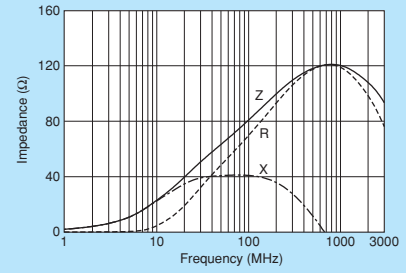

0201 Size
Chip Ferrite Bead

Chip EMIFIL®

Chip Common Mode Choke Coil

Block Type EMIFIL®

Microwave Absorber

⚠Note • Please read rating and ⚠CAUTION (for storage, operating, rating, soldering, mounting and handling) in this catalog to prevent smoking and/or burning, etc.
 • This catalog has only typical specifications. Therefore, please approve our product specifications or transact the approval sheet for product specifications before ordering.

BLM03AX Series (0201 Size)



High Spec Ferrite Bead Ultra low dc resistance and wide impedance line up. Fit for both power lines and signal lines.

Chip Ferrite Bead
0201 Size

Chip EMIFIL®

Chip Common Mode Choke Coil

Block Type EMIFIL®

Microwave Absorber



■ Dimensions

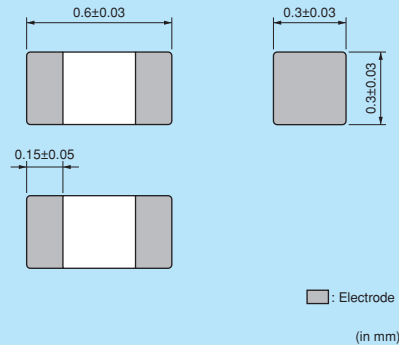

■ Equivalent Circuit

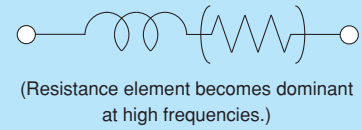

■ Packaging

Code	Packaging	Minimum Quantity
D	180mm Reel Paper Tape	15000
J	330mm Reel Paper Tape	50000
B	Bulk(Bag)	1000

Refer to pages from p.97 to p.100 for mounting information.

■ Rated Value (□: packaging code)

Part Number	Impedance (at 100MHz/20°C)	Rated Current	DC Resistance	Operating Temperature Range	
BLM03AX100SN1□	10ohm (Typ.)	1000mA	0.05ohm max.	-55°C to +125°C	Kit ≥1A
BLM03AX800SN1□	80ohm ±25%	500mA	0.18ohm max.	-55°C to +125°C	Kit
BLM03AX121SN1□	120ohm ±25%	450mA	0.23ohm max.	-55°C to +125°C	Kit
BLM03AX241SN1□	240ohm ±25%	350mA	0.38ohm max.	-55°C to +125°C	Kit
BLM03AX601SN1□	600ohm ±25%	250mA	0.85ohm max.	-55°C to +125°C	Kit
BLM03AX102SN1□	1000ohm ±25%	200mA	1.25ohm max.	-55°C to +125°C	Kit

Number of Circuits: 1

■ Impedance-Frequency Characteristics

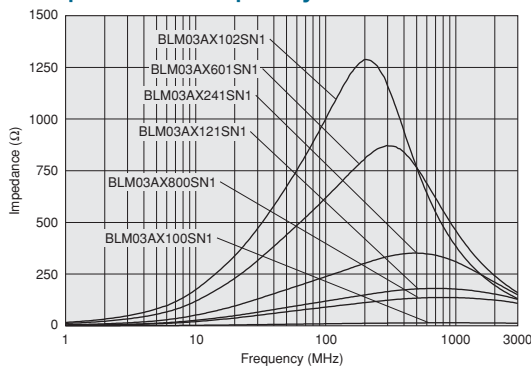

■ Impedance-Frequency Characteristics

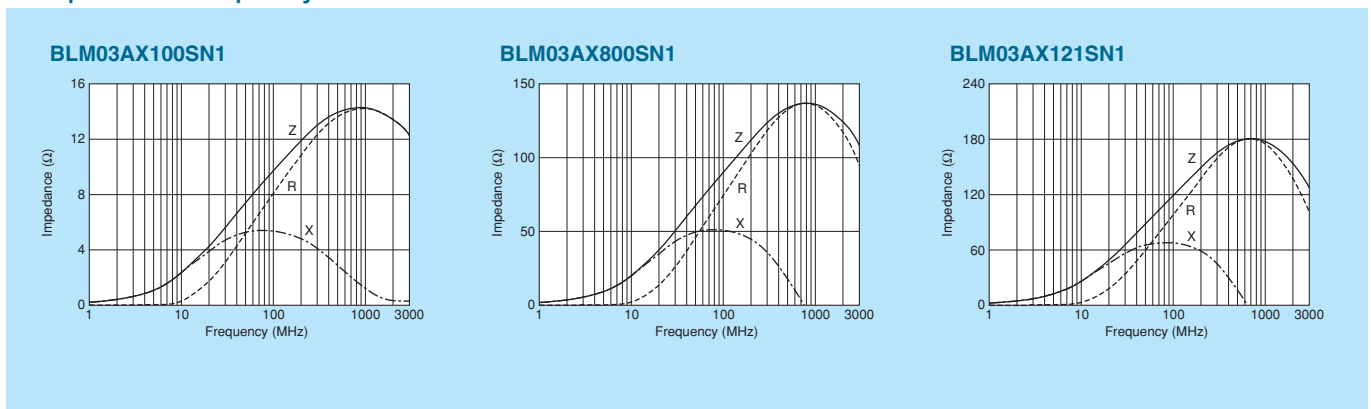

Continued on the following page.

△Note • Please read rating and △CAUTION (for storage, operating, rating, soldering, mounting and handling) in this catalog to prevent smoking and/or burning, etc.
• This catalog has only typical specifications. Therefore, please approve our product specifications or transact the approval sheet for product specifications before ordering.

Impedance-Frequency Characteristics

BLM03AX241SN1

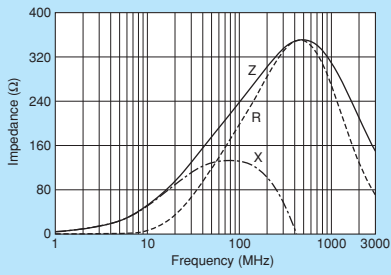

BLM03AX601SN1

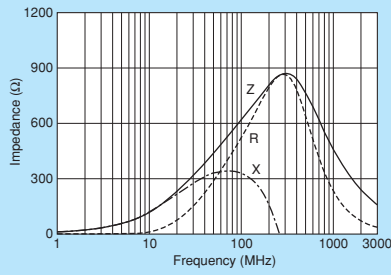

BLM03AX102SN1

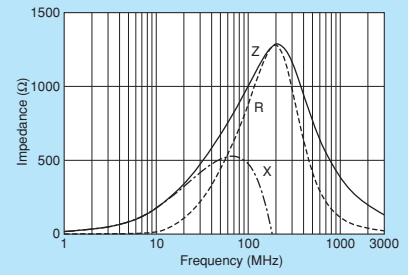

0201 Size
Chip Ferrite Bead

Chip EMIFIL®

Chip Common Mode Choke Coil

Block Type EMIFIL®

Microwave Absorber

⚠Note • Please read rating and ⚠CAUTION (for storage, operating, rating, soldering, mounting and handling) in this catalog to prevent smoking and/or burning, etc.
 • This catalog has only typical specifications. Therefore, please approve our product specifications or transact the approval sheet for product specifications before ordering.

BLM03AG Series (0201 Size)



0201 size for general signal lines.

Chip Ferrite Bead
0201 Size

Chip EMIFIL®

Chip Common Mode Choke Coil

Block Type EMIFIL®

Microwave Absorber



Dimensions

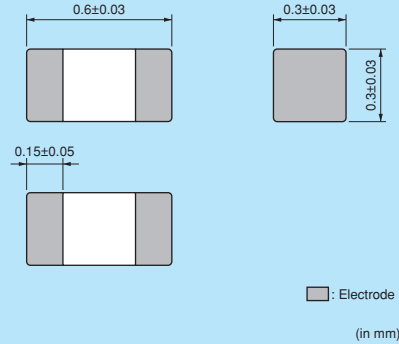

Equivalent Circuit

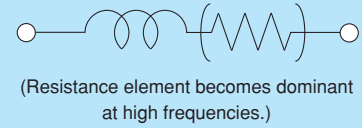

Packaging

Code	Packaging	Minimum Quantity
D	180mm Reel Paper Tape	15000
J	330mm Reel Paper Tape	50000
B	Bulk(Bag)	1000

Refer to pages from p.97 to p.100 for mounting information.

Rated Value (□: packaging code)

Part Number	Impedance (at 100MHz/20°C)	Rated Current	DC Resistance	Operating Temperature Range	
BLM03AG100SN1□	10ohm (Typ.)	500mA	0.1ohm max.	-55°C to +125°C	Kit
BLM03AG700SN1□	70ohm (Typ.)	200mA	0.4ohm max.	-55°C to +125°C	Kit
BLM03AG800SN1□	80ohm ±25%	200mA	0.4ohm max.	-55°C to +125°C	Kit
BLM03AG121SN1□	120ohm ±25%	200mA	0.5ohm max.	-55°C to +125°C	Kit
BLM03AG241SN1□	240ohm ±25%	200mA	0.8ohm max.	-55°C to +125°C	Kit
BLM03AG601SN1□	600ohm ±25%	100mA	1.5ohm max.	-55°C to +125°C	Kit
BLM03AG102SN1□	1000ohm ±25%	100mA	2.5ohm max.	-55°C to +125°C	Kit

Number of Circuits: 1

Impedance-Frequency Characteristics

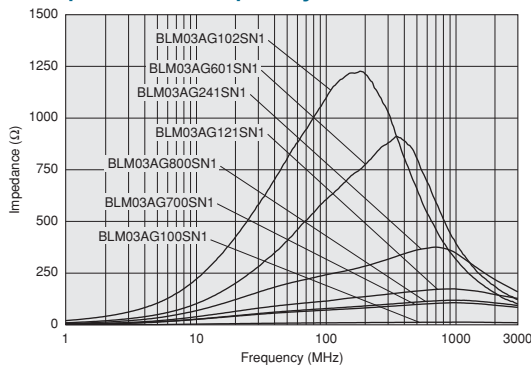

Impedance-Frequency Characteristics

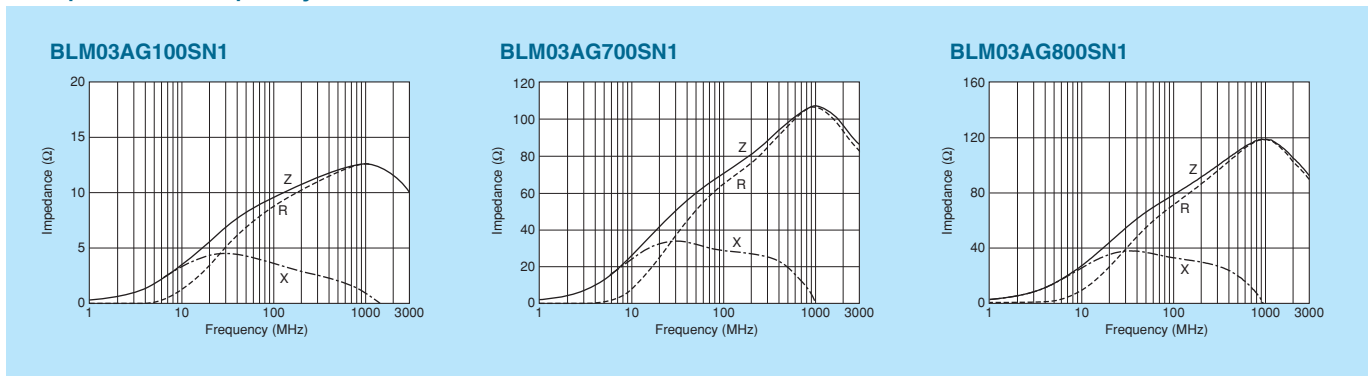

Continued on the following page.

⚠Note • Please read rating and ⚠CAUTION (for storage, operating, rating, soldering, mounting and handling) in this catalog to prevent smoking and/or burning, etc.
• This catalog has only typical specifications. Therefore, please approve our product specifications or transact the approval sheet for product specifications before ordering.

Impedance-Frequency Characteristics

BLM03AG121SN1

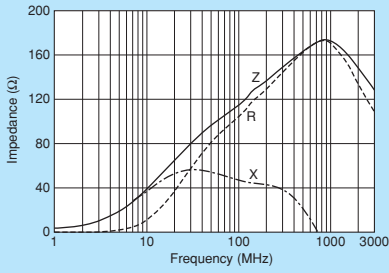

BLM03AG241SN1

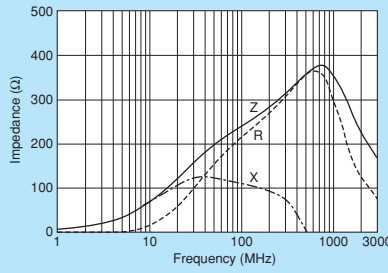

BLM03AG601SN1

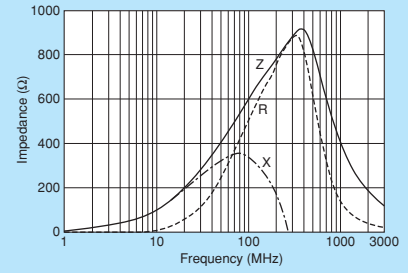

BLM03AG102SN1

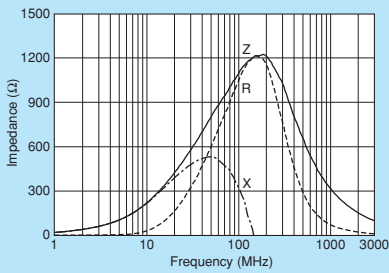

0201 Size
Chip Ferrite Bead

Chip EMIFIL®

Chip Common Mode Choke Coil

Block Type EMIFIL®

Microwave Absorber

⚠Note • Please read rating and ⚠CAUTION (for storage, operating, rating, soldering, mounting and handling) in this catalog to prevent smoking and/or burning, etc.
 • This catalog has only typical specifications. Therefore, please approve our product specifications or transact the approval sheet for product specifications before ordering.

BLM03B Series (0201 Size)



0201 size for high speed signal lines.

Chip Ferrite Bead
0201 Size

Chip EMIFIL®

Chip Common Mode Choke Coil

Block Type EMIFIL®

Microwave Absorber



Dimensions

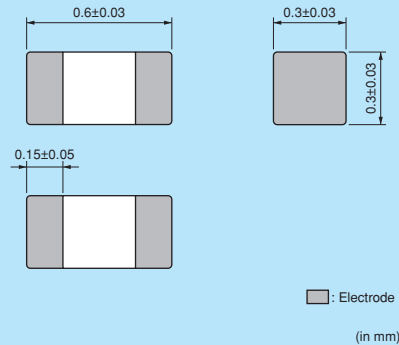

Equivalent Circuit

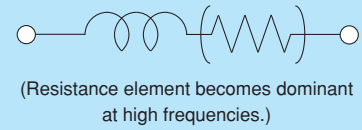

Packaging

Code	Packaging	Minimum Quantity
D	180mm Reel Paper Tape	15000
J	330mm Reel Paper Tape	50000
B	Bulk(Bag)	1000

Refer to pages from p.97 to p.100 for mounting information.

Rated Value (□: packaging code)

Part Number	Impedance (at 100MHz/20°C)	Rated Current	DC Resistance	Operating Temperature Range	
BLM03BD750SN1□	75ohm ±25%	300mA	0.4ohm max.	-55°C to +125°C	Kit
BLM03BD121SN1□	120ohm ±25%	250mA	0.5ohm max.	-55°C to +125°C	Kit
BLM03BD241SN1□	240ohm ±25%	200mA	0.8ohm max.	-55°C to +125°C	Kit
BLM03BD471SN1□	470ohm ±25%	215mA	1.5ohm max.	-55°C to +125°C	Kit
BLM03BD601SN1□	600ohm ±25%	200mA	1.7ohm max.	-55°C to +125°C	Kit
BLM03BB100SN1□	10ohm ±25%	300mA	0.4ohm max.	-55°C to +125°C	Kit
BLM03BB220SN1□	22ohm ±25%	200mA	0.5ohm max.	-55°C to +125°C	Kit
BLM03BB470SN1□	47ohm ±25%	200mA	0.7ohm max.	-55°C to +125°C	Kit
BLM03BB750SN1□	75ohm ±25%	200mA	1.0ohm max.	-55°C to +125°C	Kit
BLM03BB121SN1□	120ohm ±25%	100mA	1.5ohm max.	-55°C to +125°C	Kit
BLM03BC330SN1□	33ohm ±25%	150mA	0.85ohm max.	-55°C to +125°C	Kit
BLM03BC560SN1□	56ohm ±25%	100mA	1.05ohm max.	-55°C to +125°C	Kit
BLM03BC800SN1□	80ohm ±25%	100mA	1.40ohm max.	-55°C to +125°C	Kit

Number of Circuits: 1

Impedance-Frequency Characteristics BLM03BD Series

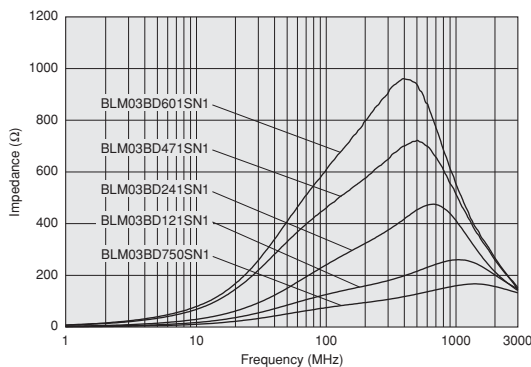

Impedance-Frequency Characteristics BLM03BB Series

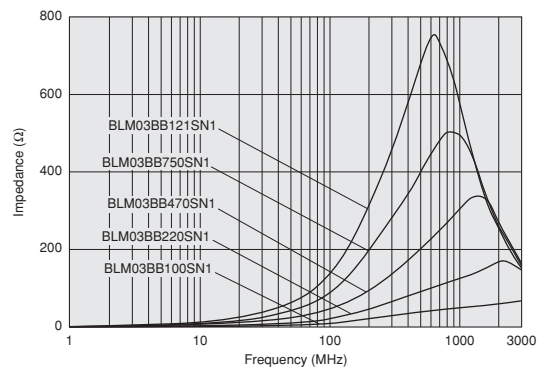

Continued on the following page. ↗

△Note • Please read rating and △CAUTION (for storage, operating, rating, soldering, mounting and handling) in this catalog to prevent smoking and/or burning, etc.
• This catalog has only typical specifications. Therefore, please approve our product specifications or transact the approval sheet for product specifications before ordering.

Impedance-Frequency Characteristics
 BLM03BC Series

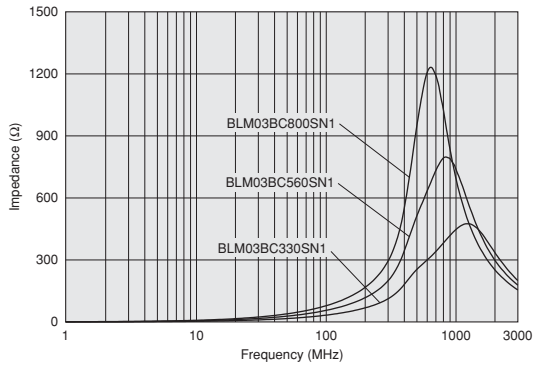

Impedance-Frequency Characteristics

BLM03BD750SN1

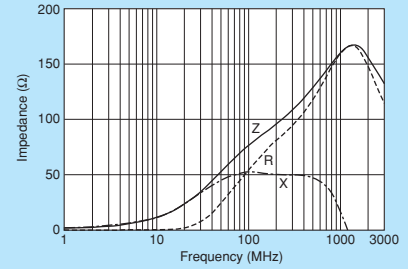

BLM03BD121SN1

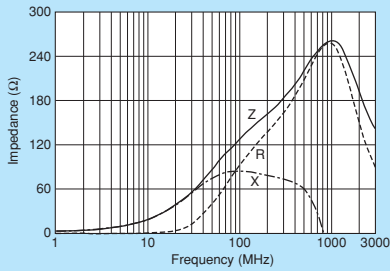

BLM03BD241SN1

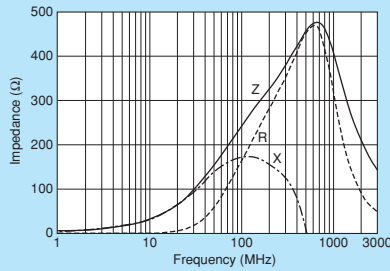

BLM03BD471SN1

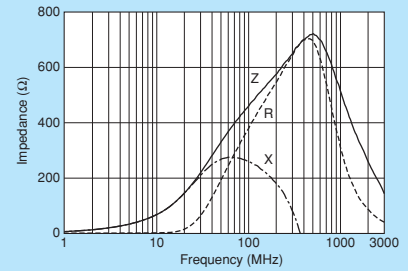

BLM03BD601SN1

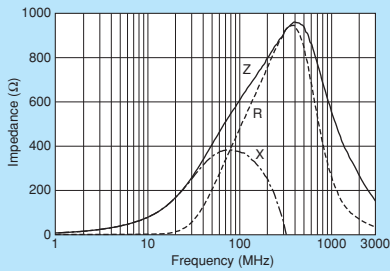

BLM03BB100SN1

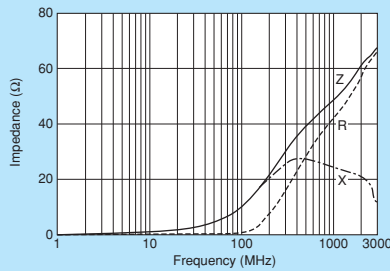

BLM03BB220SN1

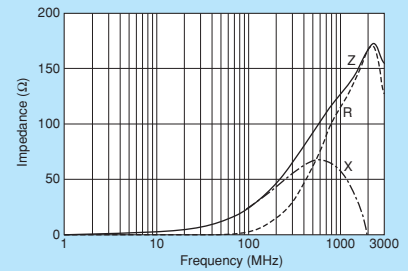

BLM03BB470SN1

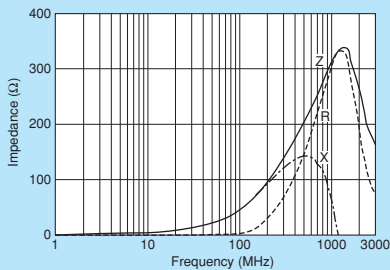

BLM03BB750SN1

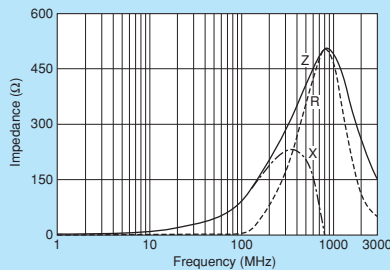

BLM03BB121SN1

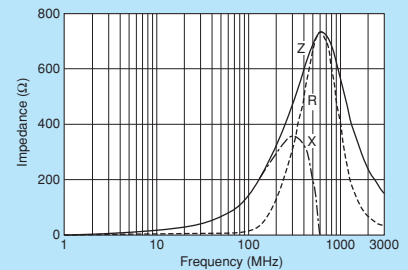

BLM03BC330SN1

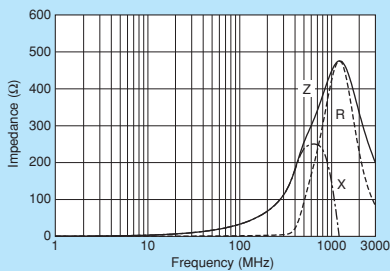

BLM03BC560SN1

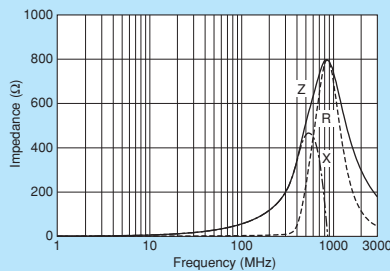

BLM03BC800SN1

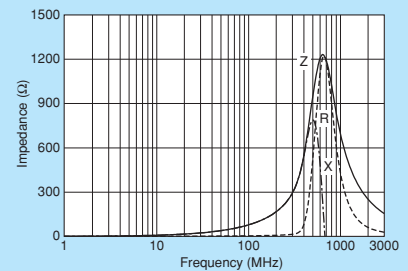

Note • Please read rating and CAUTION (for storage, operating, rating, soldering, mounting and handling) in this catalog to prevent smoking and/or burning, etc.
 • This catalog has only typical specifications. Therefore, please approve our product specifications or transact the approval sheet for product specifications before ordering.

BLM15PX Series (0402 Size)



3A max, high performance type for power lines up to 600ohm.

Chip Ferrite Bead
0402 Size

Chip EMIFIL®

Chip Common Mode Choke Coil

Block Type EMIFIL®

Microwave Absorber

■ Dimensions

(in mm)

■ Equivalent Circuit

(Resistance element becomes dominant at high frequencies.)

■ Packaging

Code	Packaging	Minimum Quantity
D	180mm Reel Paper Tape	10000
J	330mm Reel Paper Tape	50000
B	Bulk(Bag)	1000

Refer to pages from p.97 to p.100 for mounting information.

■ Rated Value (□: packaging code)

Part Number	Impedance (at 100MHz/20°C)	Rated Current	DC Resistance	Operating Temperature Range	
BLM15PX330SN1□	33ohm ±25%	3000mA	0.022ohm max.	-55°C to +125°C	New Kit ≥3A
BLM15PX600SN1□	60ohm ±25%	2500mA	0.032ohm max.	-55°C to +125°C	New Kit ≥1A
BLM15PX800SN1□	80ohm ±25%	2300mA	0.038ohm max.	-55°C to +125°C	New Kit ≥1A
BLM15PX121SN1□	120ohm ±25%	2000mA	0.055ohm max.	-55°C to +125°C	New Kit ≥1A
BLM15PX181SN1□	180ohm ±25%	1500mA	0.090ohm max.	-55°C to +125°C	New Kit ≥1A
BLM15PX221SN1□	220ohm ±25%	1400mA	0.10ohm max.	-55°C to +125°C	New Kit ≥1A
BLM15PX331SN1□	330ohm ±25%	1200mA	0.15ohm max.	-55°C to +125°C	New Kit ≥1A
BLM15PX471SN1□	470ohm ±25%	1000mA	0.20ohm max.	-55°C to +125°C	New Kit ≥1A
BLM15PX601SN1□	600ohm ±25%	900mA	0.23ohm max.	-55°C to +125°C	New Kit

Number of Circuits: 1

■ Impedance-Frequency Characteristics

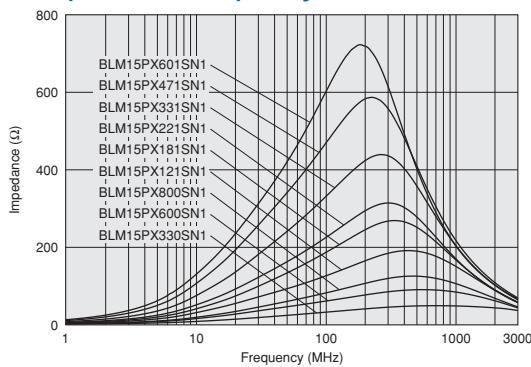

■ Notice (Rating)

In operating temperature exceeding +85°C, derating of current is necessary for BLM15PX series.

Please apply the derating curve shown in chart according to the operating temperature.

Derating of Rated Current

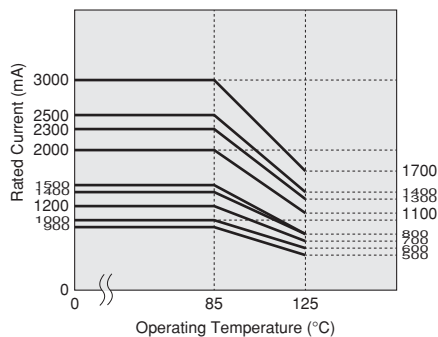

Continued on the following page. ↗

△Note • Please read rating and △CAUTION (for storage, operating, rating, soldering, mounting and handling) in this catalog to prevent smoking and/or burning, etc.
• This catalog has only typical specifications. Therefore, please approve our product specifications or transact the approval sheet for product specifications before ordering.

Impedance-Frequency Characteristics

BLM15PX330SN1

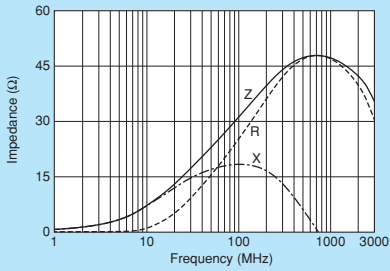

BLM15PX600SN1

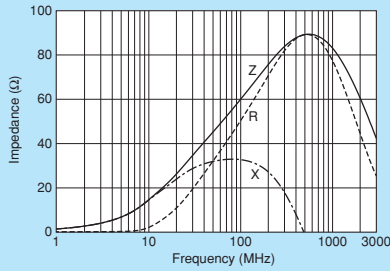

BLM15PX800SN1

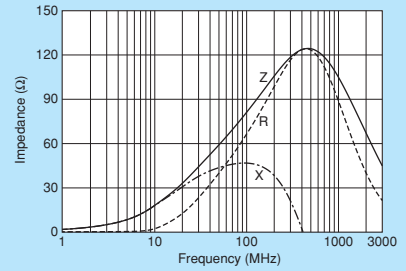

BLM15PX121SN1

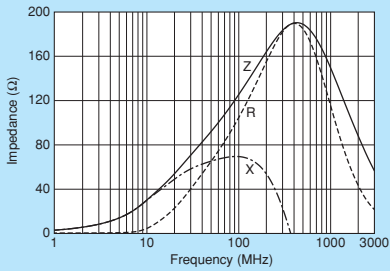

BLM15PX181SN1

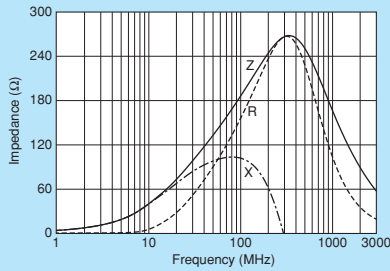

BLM15PX221SN1

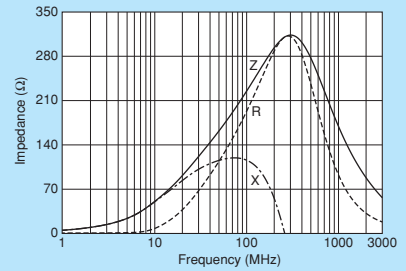

BLM15PX331SN1

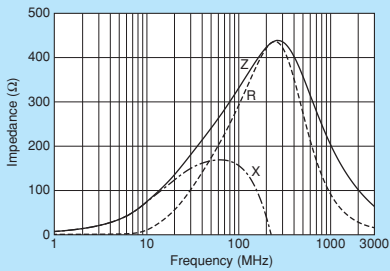

BLM15PX471SN1

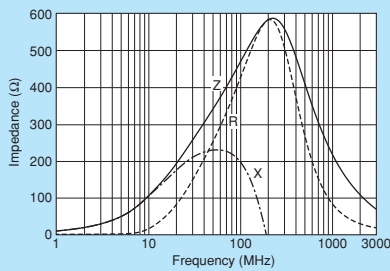

BLM15PX601SN1

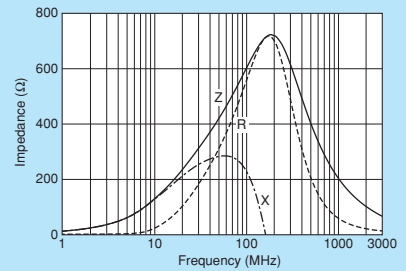

0402 Size
Chip Ferrite Bead

Chip EMIFIL®

Chip Common Mode Choke Coil

Block Type EMIFIL®

Microwave Absorber

⚠Note • Please read rating and ⚠CAUTION (for storage, operating, rating, soldering, mounting and handling) in this catalog to prevent smoking and/or burning, etc.
 • This catalog has only typical specifications. Therefore, please approve our product specifications or transact the approval sheet for product specifications before ordering.

BLM15PG/BLM15PD Series (0402 Size)



0402 size for power lines.

*Please refer to the products which are designed for both power lines and signal lines.

Chip Ferrite Bead
0402 Size

Chip EMIFIL®

Chip Common Mode Choke Coil

Block Type EMIFIL®

Microwave Absorber

■ Dimensions

(in mm)

■ : Electrode

■ Equivalent Circuit

(Resistance element becomes dominant at high frequencies.)

■ Packaging

Code	Packaging	Minimum Quantity
D	180mm Reel Paper Tape	10000
J	330mm Reel Paper Tape	50000
B	Bulk(Bag)	1000

Refer to pages from p.97 to p.100 for mounting information.

■ Rated Value (□: packaging code)

Part Number	Impedance (at 100MHz/20°C)	Rated Current	DC Resistance	Operating Temperature Range	
BLM15PG100SN1□	10ohm (Typ.)	1000mA	0.025ohm max.	-55°C to +125°C	Kit ≥1A
BLM15PD300SN1□	30ohm ±25%	2200mA	0.035ohm max.	-55°C to +125°C	Kit ≥1A
BLM15PD600SN1□	60ohm ±25%	1700mA	0.06ohm max.	-55°C to +125°C	Kit ≥1A
BLM15PD800SN1□	80ohm ±25%	1500mA	0.07ohm max.	-55°C to +125°C	Kit ≥1A
BLM15PD121SN1□	120ohm ±25%	1300mA	0.09ohm max.	-55°C to +125°C	Kit ≥1A

Number of Circuits: 1

■ Impedance-Frequency Characteristics

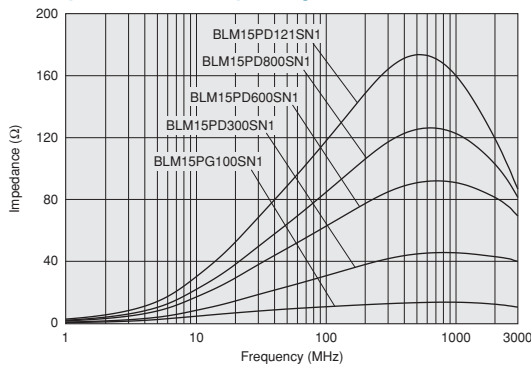

■ Notice (Rating)

In operating temperature exceeding +85°C, derating of current is necessary for BLM15PD series.

Please apply the derating curve shown in chart according to the operating temperature.

Derating of Rated Current

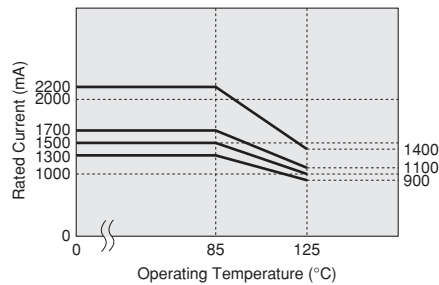

Continued on the following page.

⚠Note • Please read rating and ⚠CAUTION (for storage, operating, rating, soldering, mounting and handling) in this catalog to prevent smoking and/or burning, etc.
• This catalog has only typical specifications. Therefore, please approve our product specifications or transact the approval sheet for product specifications before ordering.

Impedance-Frequency Characteristics

BLM15PG100SN1

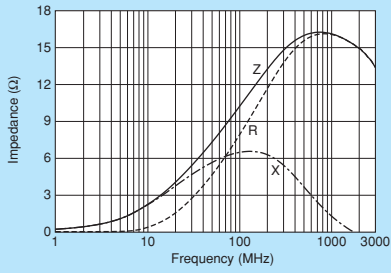

BLM15PD300SN1

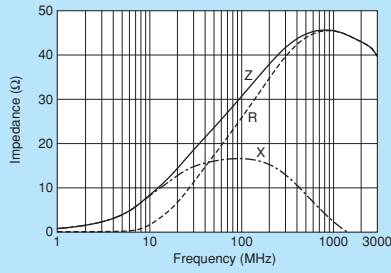

BLM15PD600SN1

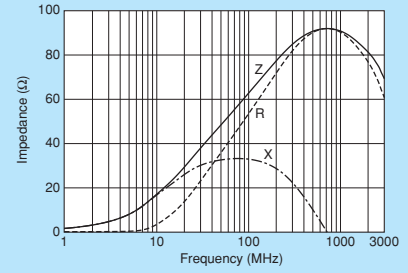

BLM15PD800SN1

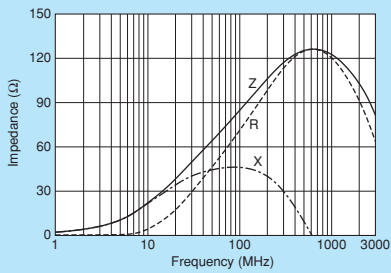

BLM15PD121SN1

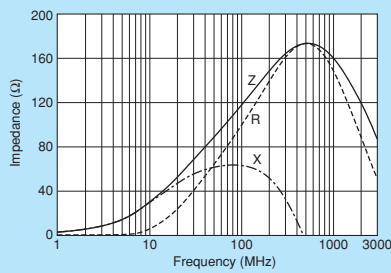

0402 Size
Chip Ferrite Bead

Chip EMIFIL®

Chip Common Mode Choke Coil

Block Type EMIFIL®

Microwave Absorber

⚠Note • Please read rating and ⚠CAUTION (for storage, operating, rating, soldering, mounting and handling) in this catalog to prevent smoking and/or burning, etc.
 • This catalog has only typical specifications. Therefore, please approve our product specifications or transact the approval sheet for product specifications before ordering.

BLM15AX Series (0402 Size)



High Spec Ferrite Bead Ultra low dc resistance and wide impedance line up. Fit for both power lines and signal lines.

Chip Ferrite Bead
0402 Size

Chip EMIFIL®

Chip Common Mode Choke Coil

Block Type EMIFIL®

Microwave Absorber

■ Dimensions

(in mm)

■: Electrode

■ Equivalent Circuit

(Resistance element becomes dominant at high frequencies.)

■ Packaging

Code	Packaging	Minimum Quantity
D	180mm Reel Paper Tape	10000
J	330mm Reel Paper Tape	50000
B	Bulk(Bag)	1000

Refer to pages from p.97 to p.100 for mounting information.

■ Rated Value (□: packaging code)

Part Number	Impedance (at 100MHz/20°C)	Rated Current	DC Resistance	Operating Temperature Range	
BLM15AX100SN1□	10ohm (Typ.)	1740mA	0.015ohm max.	-55°C to +125°C	Kit ≥1A
BLM15AX300SN1□	30ohm ±25%	1100mA	0.06ohm max.	-55°C to +125°C	Kit ≥1A
BLM15AX700SN1□	70ohm ±25%	780mA	0.1ohm max.	-55°C to +125°C	Kit
BLM15AX121SN1□	120ohm ±25%	700mA	0.13ohm max.	-55°C to +125°C	Kit
BLM15AX221SN1□	220ohm ±25%	600mA	0.18ohm max.	-55°C to +125°C	Kit
BLM15AX601SN1□	600ohm ±25%	500mA	0.34ohm max.	-55°C to +125°C	Kit
BLM15AX102SN1□	1000ohm ±25%	350mA	0.49ohm max.	-55°C to +125°C	Kit

Number of Circuits: 1

■ Impedance-Frequency Characteristics

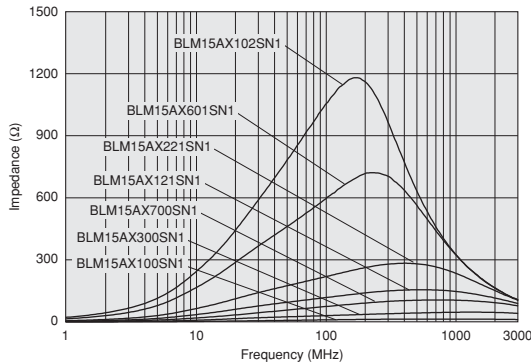

Continued on the following page. ↗

△Note • Please read rating and △CAUTION (for storage, operating, rating, soldering, mounting and handling) in this catalog to prevent smoking and/or burning, etc.
• This catalog has only typical specifications. Therefore, please approve our product specifications or transact the approval sheet for product specifications before ordering.

Impedance-Frequency Characteristics

BLM15AX100SN1

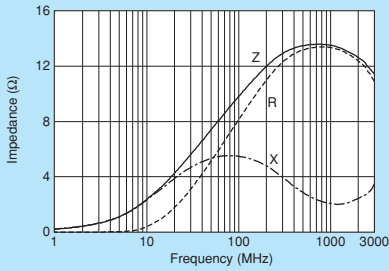

BLM15AX300SN1

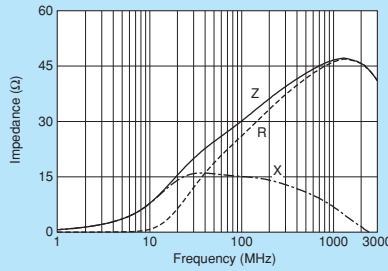

BLM15AX700SN1

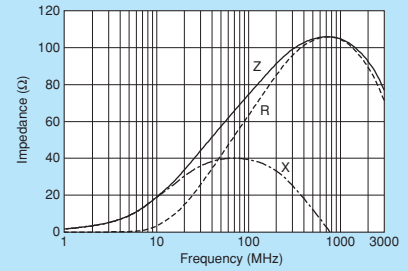

BLM15AX121SN1

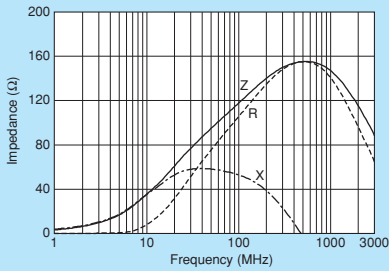

BLM15AX221SN1

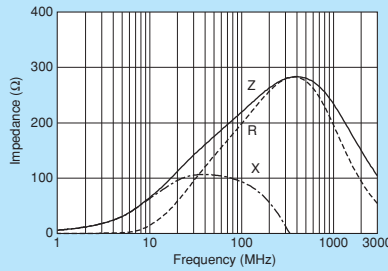

BLM15AX601SN1

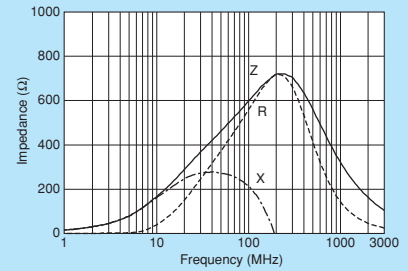

BLM15AX102SN1

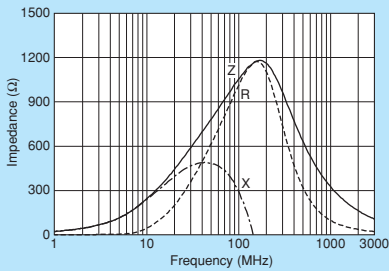

0402 Size
Chip Ferrite Bead

Chip EMIFIL®

Chip Common Mode Choke Coil

Block Type EMIFIL®

Microwave Absorber

⚠Note • Please read rating and ⚠CAUTION (for storage, operating, rating, soldering, mounting and handling) in this catalog to prevent smoking and/or burning, etc.
 • This catalog has only typical specifications. Therefore, please approve our product specifications or transact the approval sheet for product specifications before ordering.

BLM15AG Series (0402 Size)



0402 size for general signal lines.

Chip Ferrite Bead
0402 Size

Chip EMIFIL®

Chip Common Mode Choke Coil

Block Type EMIFIL®

Microwave Absorber



Dimensions

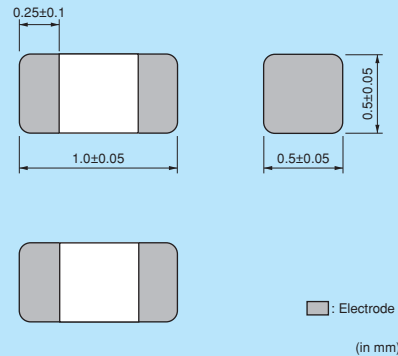

Equivalent Circuit

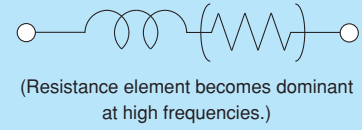

Packaging

Code	Packaging	Minimum Quantity
D	180mm Reel Paper Tape	10000
J	330mm Reel Paper Tape	50000
B	Bulk(Bag)	1000

Refer to pages from p.97 to p.100 for mounting information.

Rated Value (□: packaging code)

Part Number	Impedance (at 100MHz/20°C)	Rated Current	DC Resistance	Operating Temperature Range	
BLM15AG100SN1□	10ohm (Typ.)	1000mA	0.025ohm max.	-55°C to +125°C	Kit $\geq 1A$
BLM15AG700SN1□	70ohm (Typ.)	600mA	0.15ohm max.	-55°C to +125°C	Kit
BLM15AG121SN1□	120ohm $\pm 25\%$	550mA	0.19ohm max.	-55°C to +125°C	Kit
BLM15AG221SN1□	220ohm $\pm 25\%$	450mA	0.29ohm max.	-55°C to +125°C	Kit
BLM15AG601SN1□	600ohm $\pm 25\%$	300mA	0.52ohm max.	-55°C to +125°C	Kit
BLM15AG102SN1□	1000ohm $\pm 25\%$	300mA	0.65ohm max.	-55°C to +125°C	Kit

Number of Circuits: 1

Impedance-Frequency Characteristics

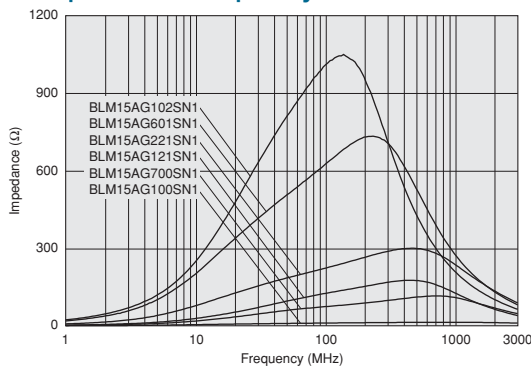

Impedance-Frequency Characteristics

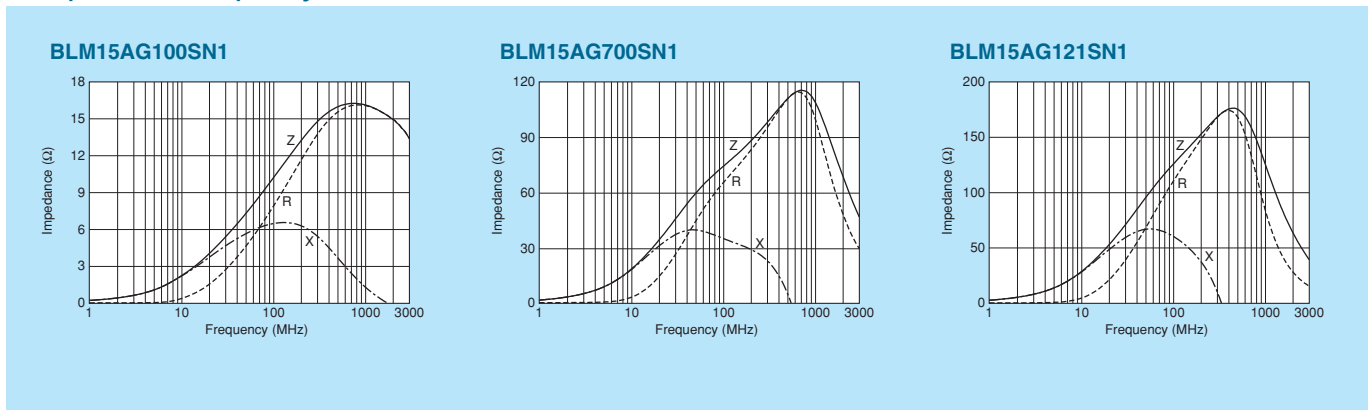

Continued on the following page.

⚠Note • Please read rating and ⚠CAUTION (for storage, operating, rating, soldering, mounting and handling) in this catalog to prevent smoking and/or burning, etc.
• This catalog has only typical specifications. Therefore, please approve our product specifications or transact the approval sheet for product specifications before ordering.

Impedance-Frequency Characteristics

BLM15AG221SN1

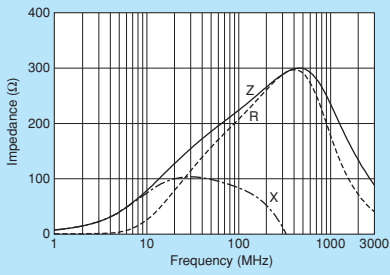

BLM15AG601SN1

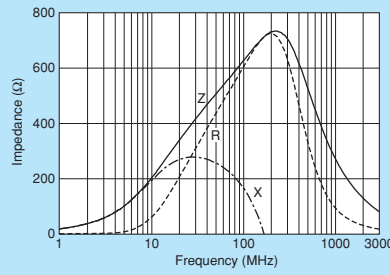

BLM15AG102SN1

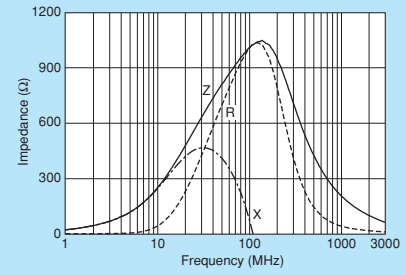

0402 Size
Chip Ferrite Bead

Chip EMIFIL®

Chip Common Mode Choke Coil

Block Type EMIFIL®

Microwave Absorber

⚠Note • Please read rating and ⚠CAUTION (for storage, operating, rating, soldering, mounting and handling) in this catalog to prevent smoking and/or burning, etc.
 • This catalog has only typical specifications. Therefore, please approve our product specifications or transact the approval sheet for product specifications before ordering.

BLM15BX Series (0402 Size)



0402 size for high speed signal lines, low DC resistance.

Chip Ferrite Bead
0402 Size

Chip EMIFIL®

Chip Common Mode Choke Coil

Block Type EMIFIL®

Microwave Absorber

■ Dimensions

(in mm)

■ Equivalent Circuit

(Resistance element becomes dominant at high frequencies.)

■ Packaging

Code	Packaging	Minimum Quantity
D	180mm Reel Paper Tape	10000
J	330mm Reel Paper Tape	50000
B	Bulk(Bag)	1000

Refer to pages from p.97 to p.100 for mounting information.

■ Rated Value (□: packaging code)

Part Number	Impedance (at 100MHz/20°C)	Rated Current	DC Resistance	Operating Temperature Range	
BLM15BX750SN1□	75ohm ±25%	600mA	0.15ohm max.	-55°C to +125°C	New Kit
BLM15BX121SN1□	120ohm ±25%	600mA	0.17ohm max.	-55°C to +125°C	New Kit
BLM15BX221SN1□	220ohm ±25%	450mA	0.27ohm max.	-55°C to +125°C	New Kit
BLM15BX471SN1□	470ohm ±25%	350mA	0.41ohm max.	-55°C to +125°C	New Kit
BLM15BX601SN1□	600ohm ±25%	350mA	0.46ohm max.	-55°C to +125°C	New Kit
BLM15BX102SN1□	1000ohm ±25%	300mA	0.65ohm max.	-55°C to +125°C	New Kit
BLM15BX182SN1□	1800ohm ±25%	250mA	0.90ohm max.	-55°C to +125°C	New Kit

Number of Circuits: 1

■ Impedance-Frequency Characteristics

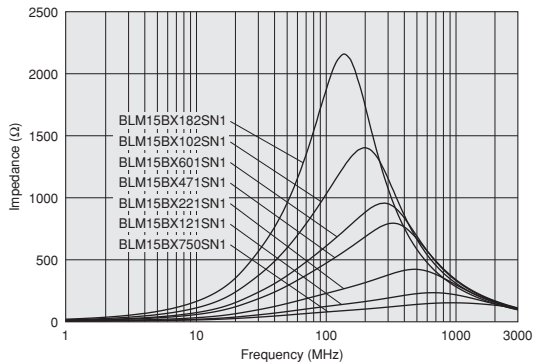

Continued on the following page.

△Note • Please read rating and △CAUTION (for storage, operating, rating, soldering, mounting and handling) in this catalog to prevent smoking and/or burning, etc.
• This catalog has only typical specifications. Therefore, please approve our product specifications or transact the approval sheet for product specifications before ordering.

Impedance-Frequency Characteristics

BLM15BX750SN1

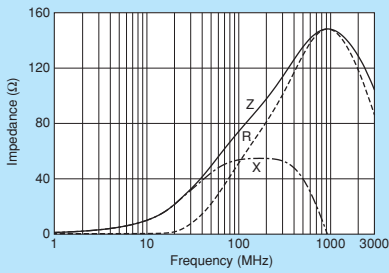

BLM15BX121SN1

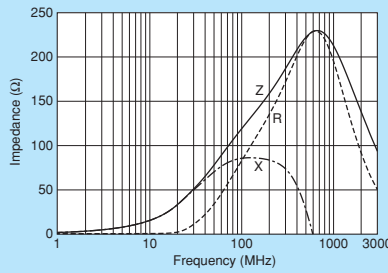

BLM15BX221SN1

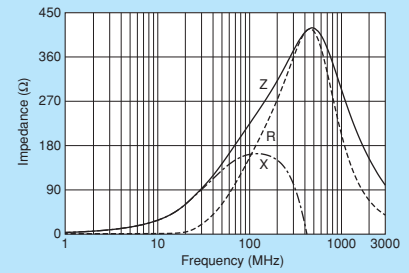

BLM15BX471SN1

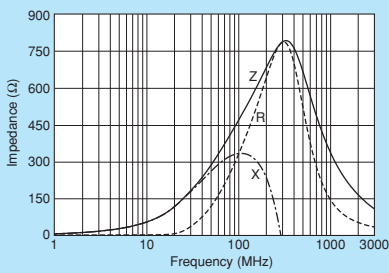

BLM15BX601SN1

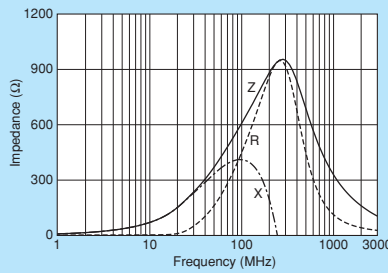

BLM15BX102SN1

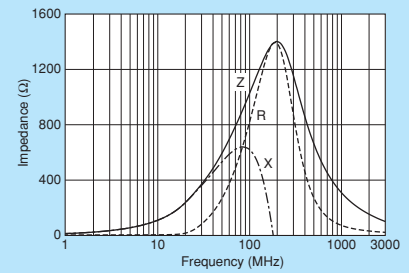

BLM15BX182SN1

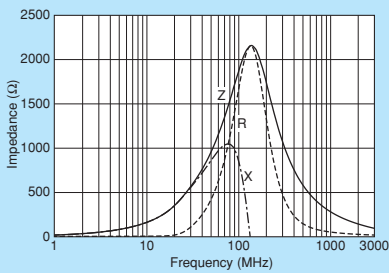

0402 Size
Chip Ferrite Bead

Chip EMIFIL®

Chip Common Mode Choke Coil

Block Type EMIFIL®

Microwave Absorber

⚠Note • Please read rating and ⚠CAUTION (for storage, operating, rating, soldering, mounting and handling) in this catalog to prevent smoking and/or burning, etc.
 • This catalog has only typical specifications. Therefore, please approve our product specifications or transact the approval sheet for product specifications before ordering.

BLM15B Series (0402 Size)



0402 size for high speed signal lines.

Chip Ferrite Bead
0402 Size

Chip EMIFIL®

Chip Common Mode Choke Coil

Block Type EMIFIL®

Microwave Absorber



■ Dimensions

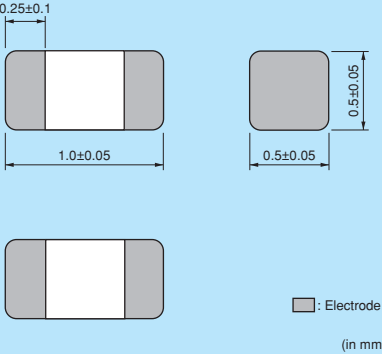

(in mm)

■ Equivalent Circuit



(Resistance element becomes dominant at high frequencies.)

■ Packaging

Code	Packaging	Minimum Quantity
D	180mm Reel Paper Tape	10000
J	330mm Reel Paper Tape	50000
B	Bulk(Bag)	1000

Refer to pages from p.97 to p.100 for mounting information.

■ Rated Value (□: packaging code)

Part Number	Impedance (at 100MHz/20°C)	Rated Current	DC Resistance	Operating Temperature Range	
BLM15BD750SN1□	75ohm ±25%	300mA	0.20ohm max.	-55°C to +125°C	Kit
BLM15BD121SN1□	120ohm ±25%	300mA	0.30ohm max.	-55°C to +125°C	Kit
BLM15BD221SN1□	220ohm ±25%	300mA	0.40ohm max.	-55°C to +125°C	Kit
BLM15BD471SN1□	470ohm ±25%	200mA	0.60ohm max.	-55°C to +125°C	Kit
BLM15BD601SN1□	600ohm ±25%	200mA	0.65ohm max.	-55°C to +125°C	Kit
BLM15BD102SN1□	1000ohm ±25%	200mA	0.90ohm max.	-55°C to +125°C	Kit
BLM15BD182SN1□	1800ohm ±25%	100mA	1.40ohm max.	-55°C to +125°C	Kit
BLM15BB050SN1□	5ohm ±25%	500mA	0.08ohm max.	-55°C to +125°C	Kit
BLM15BB100SN1□	10ohm ±25%	300mA	0.10ohm max.	-55°C to +125°C	Kit
BLM15BB220SN1□	22ohm ±25%	300mA	0.20ohm max.	-55°C to +125°C	Kit
BLM15BB470SN1□	47ohm ±25%	300mA	0.35ohm max.	-55°C to +125°C	Kit
BLM15BB750SN1□	75ohm ±25%	300mA	0.40ohm max.	-55°C to +125°C	Kit
BLM15BB121SN1□	120ohm ±25%	300mA	0.55ohm max.	-55°C to +125°C	Kit
BLM15BB221SN1□	220ohm ±25%	200mA	0.80ohm max.	-55°C to +125°C	Kit
BLM15BC121SN1□	120ohm ±25%	350mA	0.45ohm max.	-55°C to +125°C	Kit
BLM15BC241SN1□	240ohm ±25%	250mA	0.70ohm max.	-55°C to +125°C	Kit
BLM15BA050SN1□	5ohm ±25%	300mA	0.10ohm max.	-55°C to +125°C	Kit
BLM15BA100SN1□	10ohm ±25%	300mA	0.20ohm max.	-55°C to +125°C	Kit
BLM15BA220SN1□	22ohm ±25%	300mA	0.30ohm max.	-55°C to +125°C	Kit
BLM15BA330SN1□	33ohm ±25%	300mA	0.40ohm max.	-55°C to +125°C	Kit
BLM15BA470SN1□	47ohm ±25%	200mA	0.60ohm max.	-55°C to +125°C	Kit
BLM15BA750SN1□	75ohm ±25%	200mA	0.80ohm max.	-55°C to +125°C	Kit

Number of Circuits: 1

Continued on the following page.

△Note • Please read rating and △CAUTION (for storage, operating, rating, soldering, mounting and handling) in this catalog to prevent smoking and/or burning, etc.
• This catalog has only typical specifications. Therefore, please approve our product specifications or transact the approval sheet for product specifications before ordering.

Impedance-Frequency Characteristics

BLM15BD Series

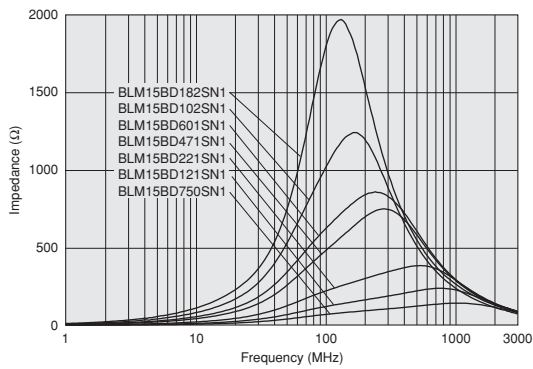

BLM15BB Series

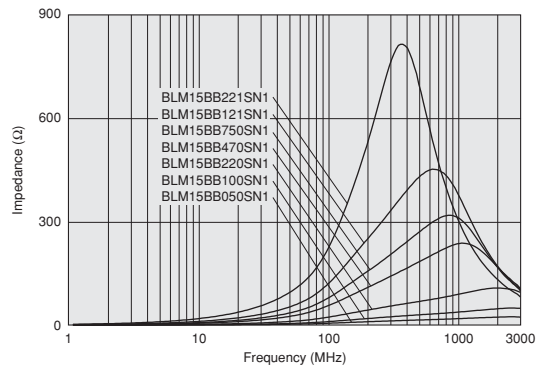

BLM15BC Series

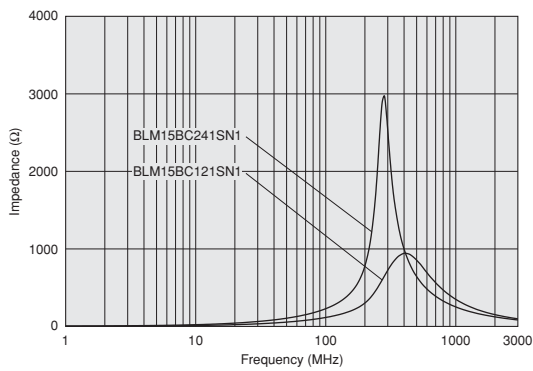

BLM15BA Series

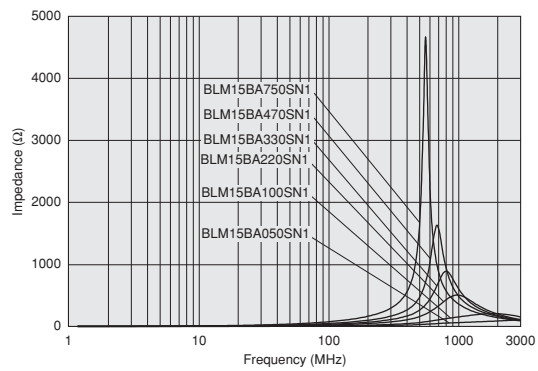

Impedance-Frequency Characteristics

BLM15BD750SN1

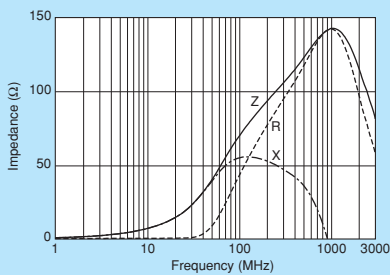

BLM15BD121SN1

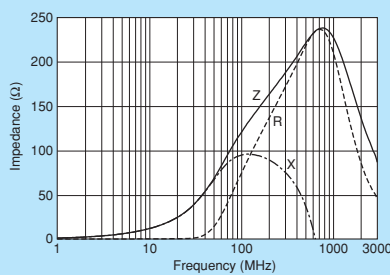

BLM15BD221SN1

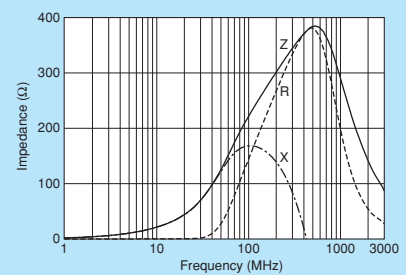

BLM15BD471SN1

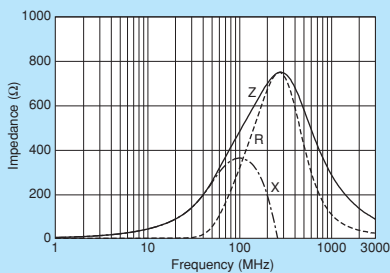

BLM15BD601SN1

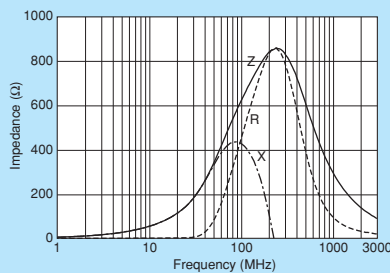

BLM15BD102SN1

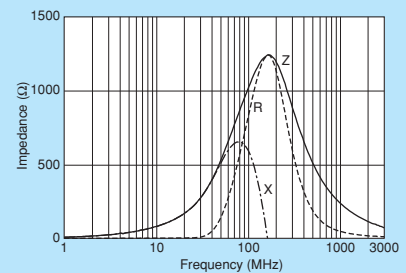

Continued on the following page.

Note • Please read rating and **CAUTION** (for storage, operating, rating, soldering, mounting and handling) in this catalog to prevent smoking and/or burning, etc.
 • This catalog has only typical specifications. Therefore, please approve our product specifications or transact the approval sheet for product specifications before ordering.

Impedance-Frequency Characteristics

BLM15BD182SN1

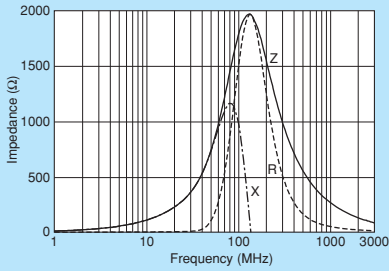

BLM15BB050SN1

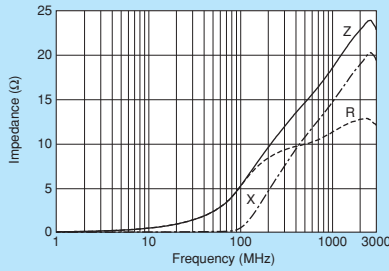

BLM15BB100SN1

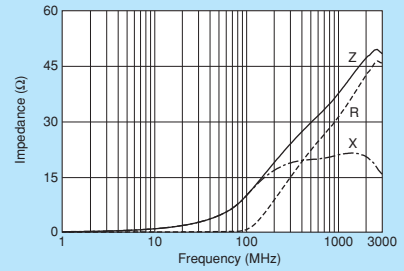

BLM15BB220SN1

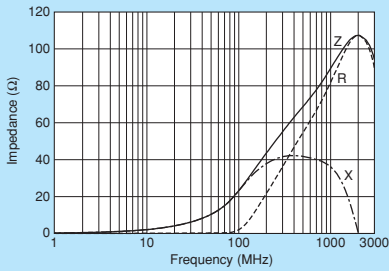

BLM15BB470SN1

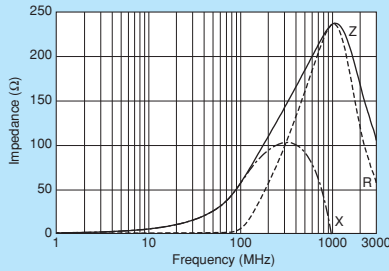

BLM15BB750SN1

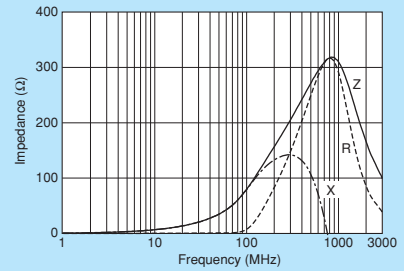

BLM15BB121SN1

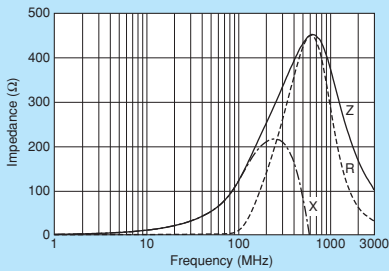

BLM15BB221SN1

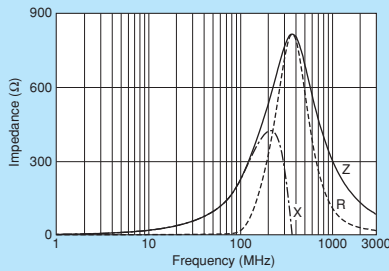

BLM15BC121SN1

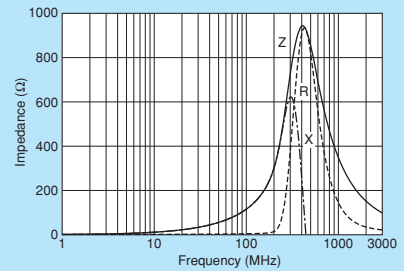

BLM15BC241SN1

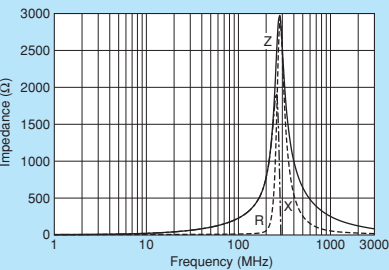

BLM15BA050SN1

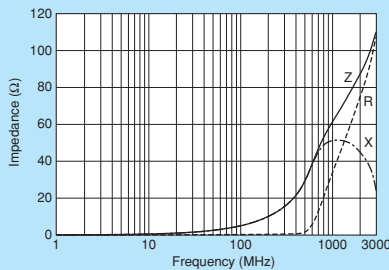

BLM15BA100SN1

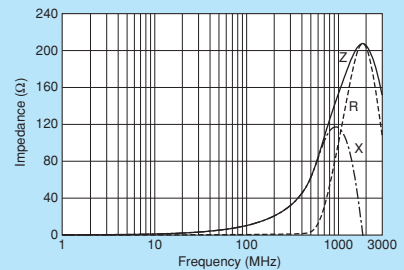

BLM15BA220SN1

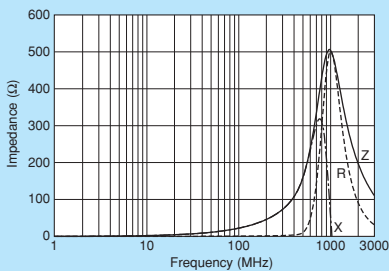

BLM15BA330SN1

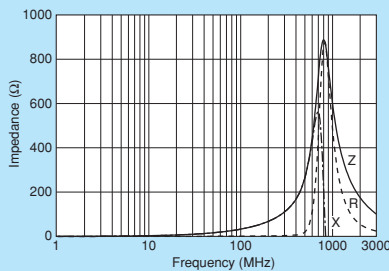

BLM15BA470SN1

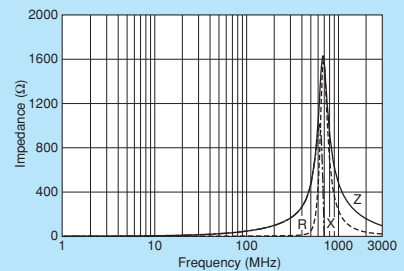

Continued on the following page.

Note • Please read rating and CAUTION (for storage, operating, rating, soldering, mounting and handling) in this catalog to prevent smoking and/or burning, etc.
 • This catalog has only typical specifications. Therefore, please approve our product specifications or transact the approval sheet for product specifications before ordering.

Chip Ferrite Bead
 0402 Size

Chip EMIFIL®

Chip Common Mode Choke Coil

Block Type EMIFIL®

Microwave Absorber

Impedance-Frequency Characteristics

BLM15BA750SN1

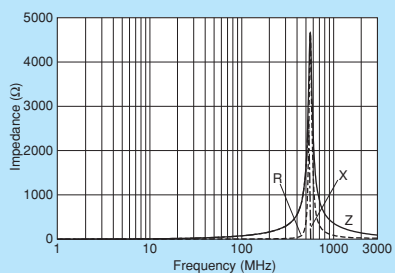

0402 Size
Chip Ferrite Bead

Chip EMIFIL®

Chip Common Mode Choke Coil

Block Type EMIFIL®

Microwave Absorber

⚠Note • Please read rating and ⚠CAUTION (for storage, operating, rating, soldering, mounting and handling) in this catalog to prevent smoking and/or burning, etc.
• This catalog has only typical specifications. Therefore, please approve our product specifications or transact the approval sheet for product specifications before ordering.

BLM18P Series (0603 Size)



0603 size for power lines.

*Please refer to the products designed for both power lines and signal lines.

Chip Ferrite Bead
0603 Size

Chip EMIFIL®

Chip Common Mode Choke Coil

Block Type EMIFIL®

Microwave Absorber



■ Dimensions

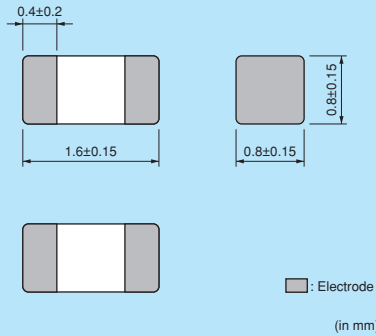

■ Equivalent Circuit

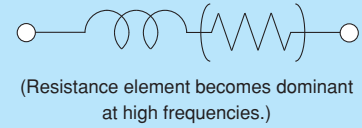

■ Packaging

Code	Packaging	Minimum Quantity
D	180mm Reel Paper Tape	4000
J	330mm Reel Paper Tape	10000
B	Bulk(Bag)	1000

Refer to pages from p.97 to p.100 for mounting information.

■ Rated Value (□: packaging code)

Part Number	Impedance (at 100MHz/20°C)	Rated Current	DC Resistance	Operating Temperature Range	
BLM18PG300SN1□	30ohm (Typ.)	1000mA	0.05ohm max.	-55°C to +125°C	Kit ≥1A
BLM18PG330SN1□	33ohm ±25%	3000mA	0.025ohm max.	-55°C to +125°C	Kit ≥3A
BLM18PG600SN1□	60ohm (Typ.)	500mA	0.10ohm max.	-55°C to +125°C	Kit
BLM18PG121SN1□	120ohm ±25%	2000mA	0.05ohm max.	-55°C to +125°C	Kit ≥1A
BLM18PG181SN1□	180ohm ±25%	1500mA	0.09ohm max.	-55°C to +125°C	Kit ≥1A
BLM18PG221SN1□	220ohm ±25%	1400mA	0.10ohm max.	-55°C to +125°C	Kit ≥1A
BLM18PG331SN1□	330ohm ±25%	1200mA	0.15ohm max.	-55°C to +125°C	Kit ≥1A
BLM18PG471SN1□	470ohm ±25%	1000mA	0.20ohm max.	-55°C to +125°C	Kit ≥1A

Number of Circuits: 1

■ Impedance-Frequency Characteristics

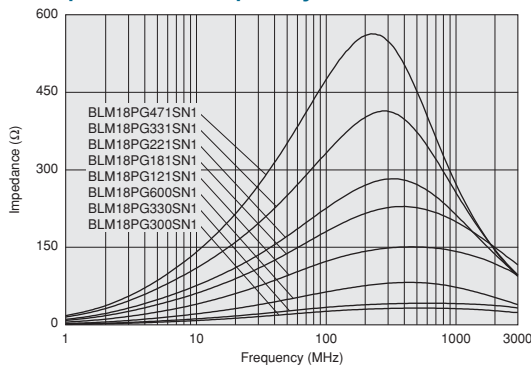

■ Notice (Rating)

In operating temperature exceeding +85°C, derating of current is necessary for BLM18PG series.

Please apply the derating curve shown in chart according to the operating temperature.

Derating of Rated Current

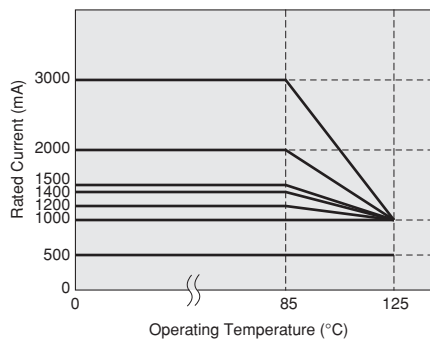

Continued on the following page. ↗

△Note • Please read rating and △CAUTION (for storage, operating, rating, soldering, mounting and handling) in this catalog to prevent smoking and/or burning, etc.
 • This catalog has only typical specifications. Therefore, please approve our product specifications or transact the approval sheet for product specifications before ordering.

Impedance-Frequency Characteristics

BLM18PG300SN1

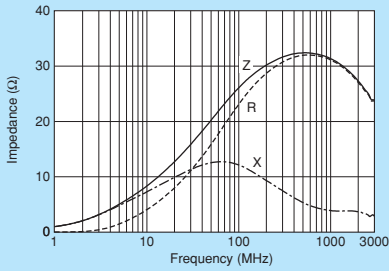

BLM18PG330SN1

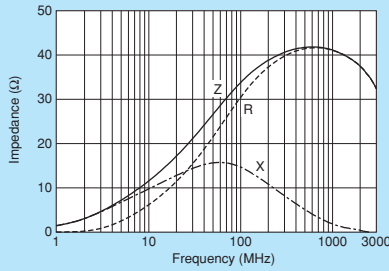

BLM18PG600SN1

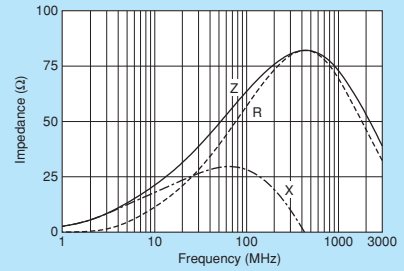

BLM18PG121SN1

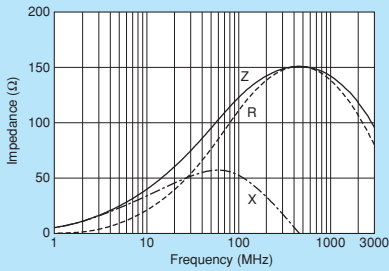

BLM18PG181SN1

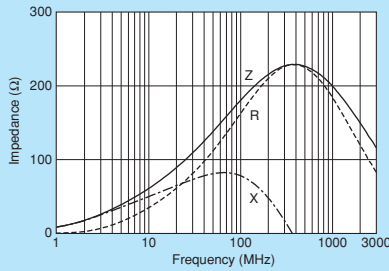

BLM18PG221SN1

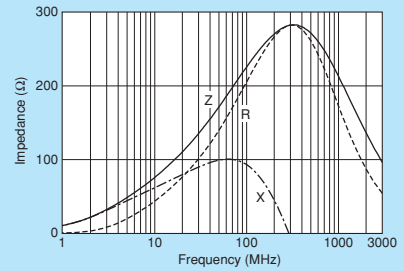

BLM18PG331SN1

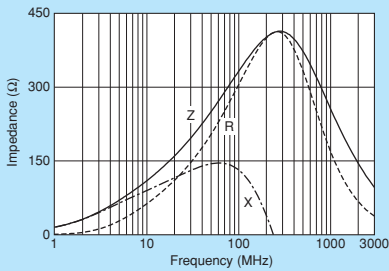

BLM18PG471SN1

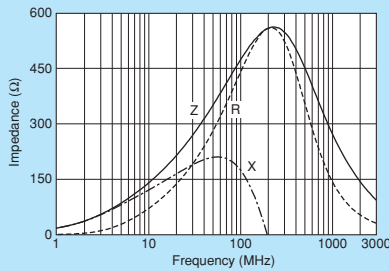

0603 Size
Chip Ferrite Bead

Chip EMIFIL®

Chip Common Mode Choke Coil

Block Type EMIFIL®

Microwave Absorber

⚠Note • Please read rating and ⚠CAUTION (for storage, operating, rating, soldering, mounting and handling) in this catalog to prevent smoking and/or burning, etc.
 • This catalog has only typical specifications. Therefore, please approve our product specifications or transact the approval sheet for product specifications before ordering.

BLM18K Series (0603 Size)



6A max, high performance type for power lines up to 600ohm.

*Please refer to the products designed for both power lines and signal lines.

Chip Ferrite Bead
0603 Size

Chip EMIFIL®

Chip Common Mode Choke Coil

Block Type EMIFIL®

Microwave Absorber



■ Dimensions

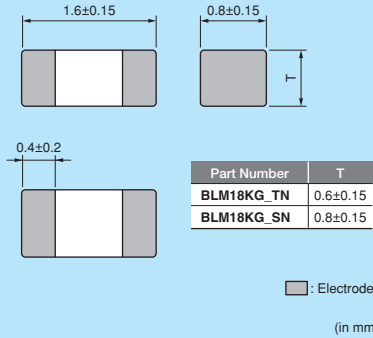

■ Equivalent Circuit

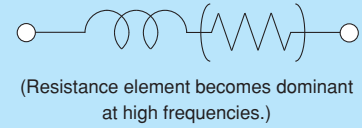

■ Packaging

Code	Packaging	Minimum Quantity
D	180mm Reel Paper Tape	4000
J	330mm Reel Paper Tape	10000
B	Bulk(Bag)	1000

Refer to pages from p.97 to p.100 for mounting information.

■ Rated Value (□: packaging code)

Part Number	Impedance (at 100MHz/20°C)	Rated Current	DC Resistance	Operating Temperature Range	Kit	Current Rating
BLM18KG260TN1□	26ohm ±25%	6000mA	0.007ohm max.	-55°C to +125°C	Kit	≥3A
BLM18KG300TN1□	30ohm ±25%	5000mA	0.010ohm max.	-55°C to +125°C	Kit	≥3A
BLM18KG700TN1□	70ohm ±25%	3500mA	0.022ohm max.	-55°C to +125°C	Kit	≥3A
BLM18KG101TN1□	100ohm ±25%	3000mA	0.030ohm max.	-55°C to +125°C	Kit	≥3A
BLM18KG121TN1□	120ohm ±25%	3000mA	0.030ohm max.	-55°C to +125°C	Kit	≥3A
BLM18KG221SN1□	220ohm ±25%	2200mA	0.050ohm max.	-55°C to +125°C	Kit	≥1A
BLM18KG331SN1□	330ohm ±25%	1700mA	0.080ohm max.	-55°C to +125°C	Kit	≥1A
BLM18KG471SN1□	470ohm ±25%	1500mA	0.130ohm max.	-55°C to +125°C	Kit	≥1A
BLM18KG601SN1□	600ohm ±25%	1300mA	0.150ohm max.	-55°C to +125°C	Kit	≥1A

Number of Circuits: 1

■ Impedance-Frequency Characteristics

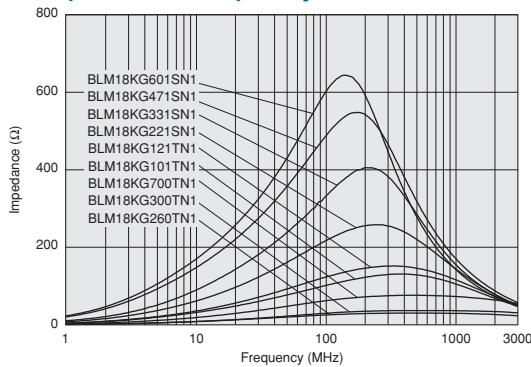

■ Notice (Rating)

In operating temperature exceeding +85°C, derating of current is necessary for BLM18KG series. Please apply the derating curve shown in chart according to the operating temperature.

Derating of Rated Current

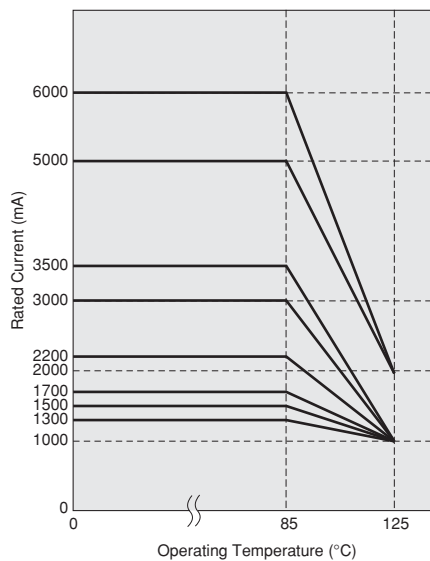

Continued on the following page.

△Note • Please read rating and △CAUTION (for storage, operating, rating, soldering, mounting and handling) in this catalog to prevent smoking and/or burning, etc.
• This catalog has only typical specifications. Therefore, please approve our product specifications or transact the approval sheet for product specifications before ordering.

Impedance-Frequency Characteristics

BLM18KG260TN1

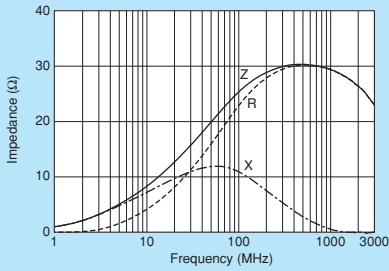

BLM18KG300TN1

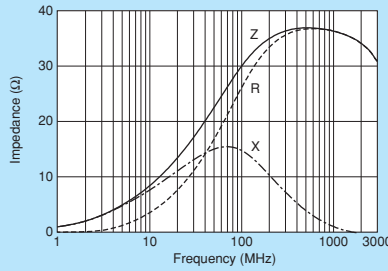

BLM18KG700TN1

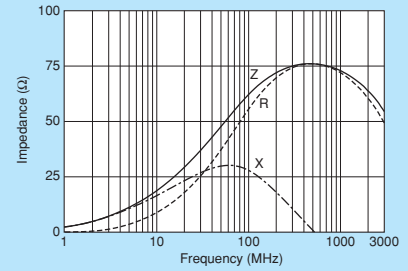

BLM18KG101TN1

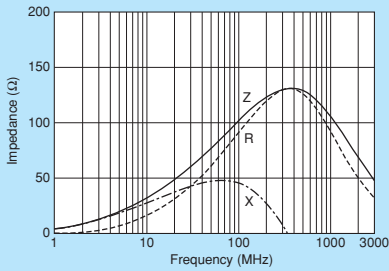

BLM18KG121TN1

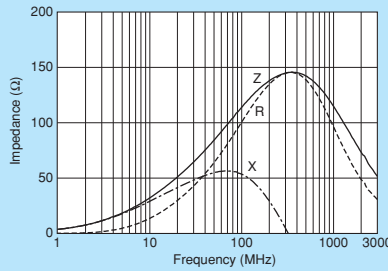

BLM18KG221SN1

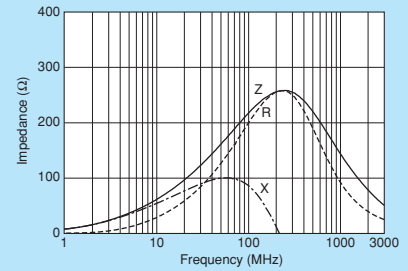

BLM18KG331SN1

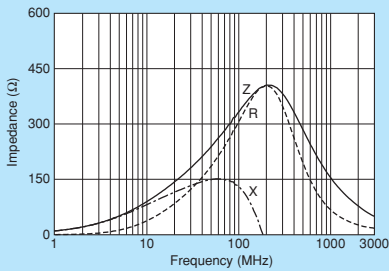

BLM18KG471SN1

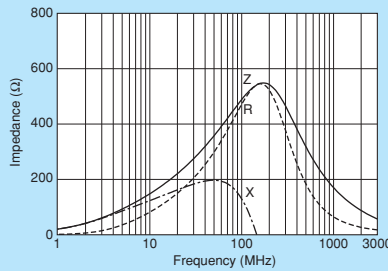

BLM18KG601SN1

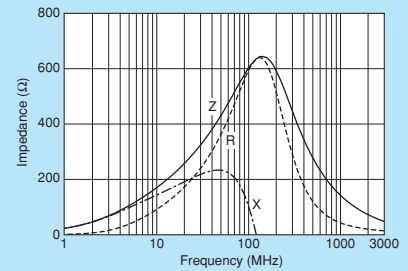

0603 Size
Chip Ferrite Bead

Chip EMIFIL®

Chip Common Mode Choke Coil

Block Type EMIFIL®

Microwave Absorber

⚠Note • Please read rating and ⚠CAUTION (for storage, operating, rating, soldering, mounting and handling) in this catalog to prevent smoking and/or burning, etc.
 • This catalog has only typical specifications. Therefore, please approve our product specifications or transact the approval sheet for product specifications before ordering.

BLM18S Series (0603 Size)



6A max, high performance type for power lines.

*Please refer to the products designed for both power lines and signal lines.

Chip Ferrite Bead
0603 Size

Chip EMIFIL®

Chip Common Mode Choke Coil

Block Type EMIFIL®

Microwave Absorber

■ Dimensions

(in mm)

■ Equivalent Circuit

(Resistance element becomes dominant at high frequencies.)

■ Packaging

Code	Packaging	Minimum Quantity
D	180mm Reel Paper Tape	10000
J	330mm Reel Paper Tape	30000
B	Bulk(Bag)	1000

Refer to pages from p.97 to p.100 for mounting information.

■ Rated Value (□: packaging code)

Part Number	Impedance (at 100MHz/20°C)	Rated Current	DC Resistance	Operating Temperature Range	Kit	Current
BLM18SG260TN1□	26ohm ±25%	6000mA	0.007ohm max.	-55°C to +125°C	Kit	≥3A
BLM18SG700TN1□	70ohm ±25%	4000mA	0.020ohm max.	-55°C to +125°C	Kit	≥3A
BLM18SG121TN1□	120ohm ±25%	3000mA	0.025ohm max.	-55°C to +125°C	Kit	≥3A
BLM18SG221TN1□	220ohm ±25%	2500mA	0.040ohm max.	-55°C to +125°C	Kit	≥1A
BLM18SG331TN1□	330ohm ±25%	1500mA	0.070ohm max.	-55°C to +125°C	Kit	≥1A

Number of Circuits: 1

■ Impedance-Frequency Characteristics

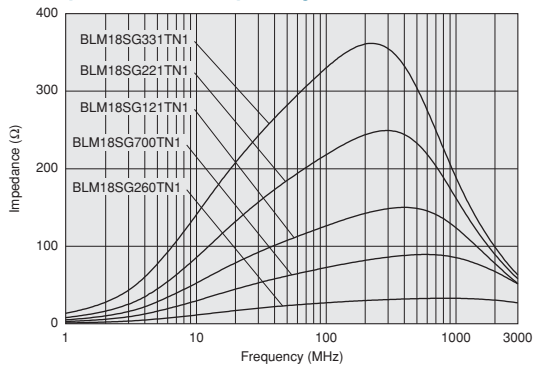

■ Notice (Rating)

In operating temperature exceeding +85°C, derating of current is necessary for BLM18SG series.

Please apply the derating curve shown in chart according to the operating temperature.

Derating of Rated Current

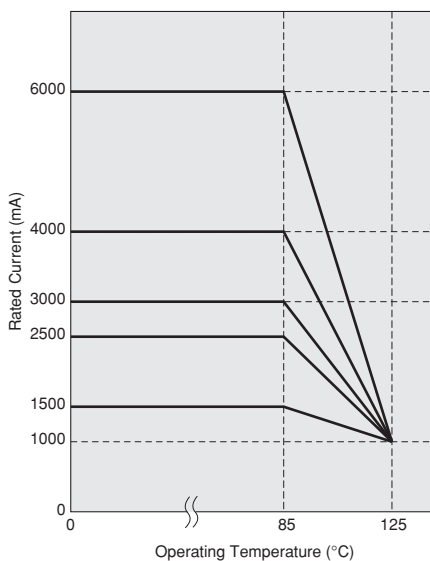

Continued on the following page.

△Note • Please read rating and △CAUTION (for storage, operating, rating, soldering, mounting and handling) in this catalog to prevent smoking and/or burning, etc.
• This catalog has only typical specifications. Therefore, please approve our product specifications or transact the approval sheet for product specifications before ordering.

Impedance-Frequency Characteristics

BLM18SG260TN1

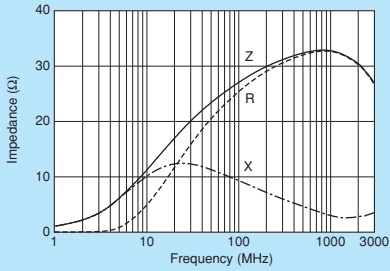

BLM18SG700TN1

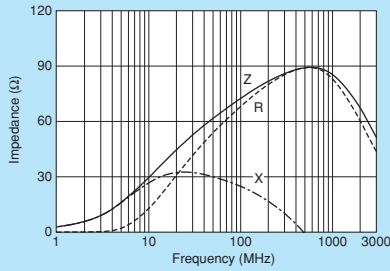

BLM18SG121TN1

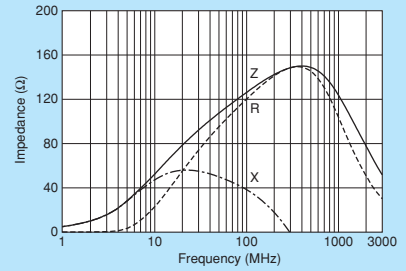

BLM18SG221TN1

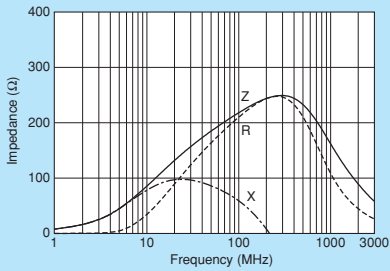

BLM18SG331TN1

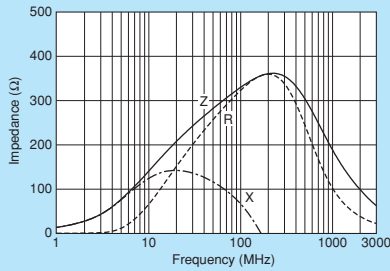

0603 Size
 Chip Ferrite Bead

Chip EMIFIL®

Chip Common Mode Choke Coil

Block Type EMIFIL®

Microwave Absorber

⚠Note • Please read rating and ⚠CAUTION (for storage, operating, rating, soldering, mounting and handling) in this catalog to prevent smoking and/or burning, etc.
 • This catalog has only typical specifications. Therefore, please approve our product specifications or transact the approval sheet for product specifications before ordering.

BLM18A Series (0603 Size)



0603 size for general signal lines.

*Please refer to BLM15A for downsizing.

Chip Ferrite Bead
0603 Size

Chip EMIFIL®

Chip Common Mode Choke Coil

Block Type EMIFIL®

Microwave Absorber



■ Dimensions

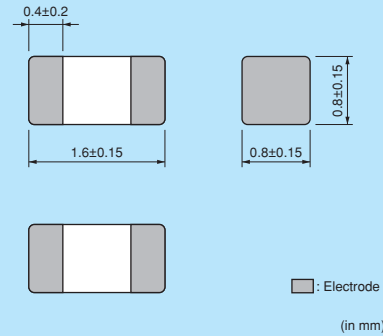

■ Equivalent Circuit

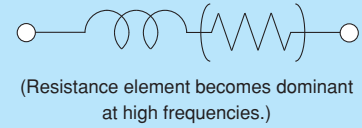

■ Packaging

Code	Packaging	Minimum Quantity
D	180mm Reel Paper Tape	4000
J	330mm Reel Paper Tape	10000
B	Bulk(Bag)	1000

Refer to pages from p.97 to p.100 for mounting information.

■ Rated Value (□: packaging code)

Part Number	Impedance (at 100MHz/20°C)	Rated Current	DC Resistance	Operating Temperature Range	
BLM18AG121SN1□	120ohm ±25%	500mA	0.18ohm max.	-55°C to +125°C	Kit
BLM18AG151SN1□	150ohm ±25%	500mA	0.25ohm max.	-55°C to +125°C	Kit
BLM18AG221SN1□	220ohm ±25%	500mA	0.25ohm max.	-55°C to +125°C	Kit
BLM18AG331SN1□	330ohm ±25%	500mA	0.30ohm max.	-55°C to +125°C	Kit
BLM18AG471SN1□	470ohm ±25%	500mA	0.35ohm max.	-55°C to +125°C	Kit
BLM18AG601SN1□	600ohm ±25%	500mA	0.38ohm max.	-55°C to +125°C	Kit
BLM18AG102SN1□	1000ohm ±25%	400mA	0.50ohm max.	-55°C to +125°C	Kit

Number of Circuits: 1

■ Impedance-Frequency Characteristics

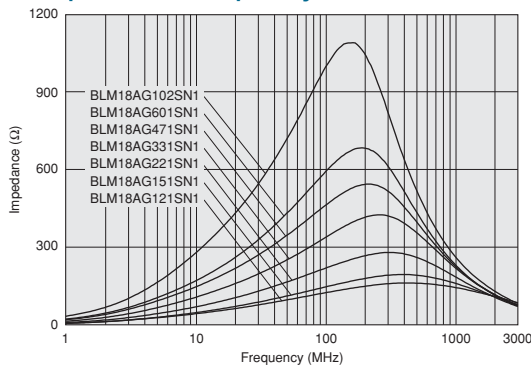

■ Impedance-Frequency Characteristics

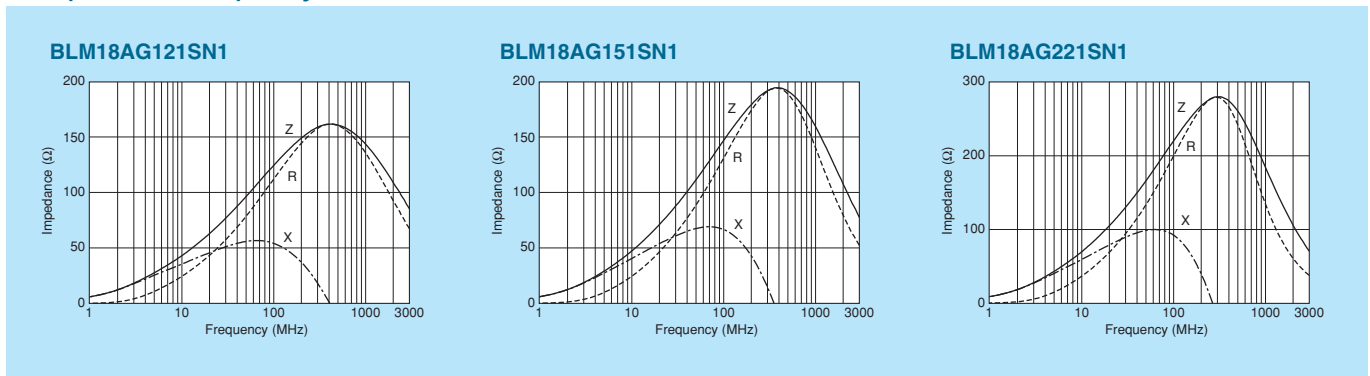

Continued on the following page. ↗

△Note • Please read rating and △CAUTION (for storage, operating, rating, soldering, mounting and handling) in this catalog to prevent smoking and/or burning, etc.
• This catalog has only typical specifications. Therefore, please approve our product specifications or transact the approval sheet for product specifications before ordering.

Impedance-Frequency Characteristics

BLM18AG331SN1

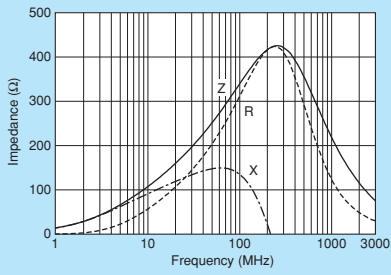

BLM18AG471SN1

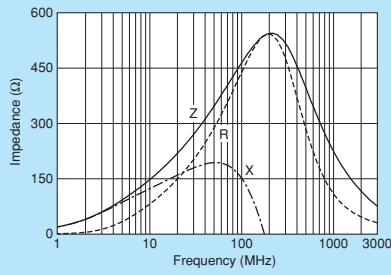

BLM18AG601SN1

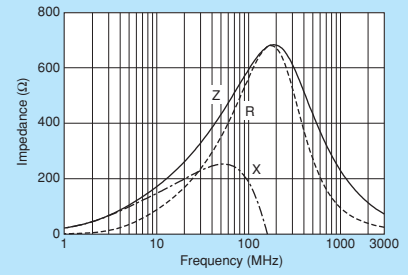

BLM18AG102SN1

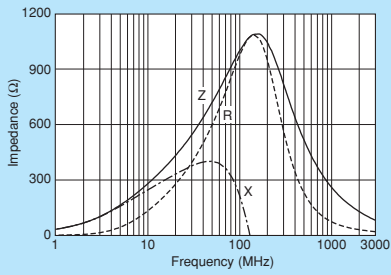

0603 Size
Chip Ferrite Bead

Chip EMIFIL®

Chip Common Mode Choke Coil

Block Type EMIFIL®

Microwave Absorber

⚠Note • Please read rating and ⚠CAUTION (for storage, operating, rating, soldering, mounting and handling) in this catalog to prevent smoking and/or burning, etc.
 • This catalog has only typical specifications. Therefore, please approve our product specifications or transact the approval sheet for product specifications before ordering.

BLM18B Series (0603 Size)



0603 size for high speed signal lines.

*Please refer to BLM15B for downsizing.

■ Dimensions

(in mm)

■ Equivalent Circuit

(Resistance element becomes dominant at high frequencies.)

■ Packaging

Code	Packaging	Minimum Quantity
D	180mm Reel Paper Tape	4000
J	330mm Reel Paper Tape	10000
B	Bulk(Bag)	1000

Refer to pages from p.97 to p.100 for mounting information.

■ Rated Value (□: packaging code)

Part Number	Impedance (at 100MHz/20°C)	Rated Current	DC Resistance	Operating Temperature Range	
BLM18BD470SN1□	47ohm ±25%	500mA	0.30ohm max.	-55°C to +125°C	Kit
BLM18BD121SN1□	120ohm ±25%	200mA	0.40ohm max.	-55°C to +125°C	Kit
BLM18BD151SN1□	150ohm ±25%	200mA	0.40ohm max.	-55°C to +125°C	Kit
BLM18BD221SN1□	220ohm ±25%	200mA	0.45ohm max.	-55°C to +125°C	Kit
BLM18BD331SN1□	330ohm ±25%	200mA	0.50ohm max.	-55°C to +125°C	Kit
BLM18BD421SN1□	420ohm ±25%	200mA	0.55ohm max.	-55°C to +125°C	Kit
BLM18BD471SN1□	470ohm ±25%	200mA	0.55ohm max.	-55°C to +125°C	Kit
BLM18BD601SN1□	600ohm ±25%	200mA	0.65ohm max.	-55°C to +125°C	Kit
BLM18BD102SN1□	1000ohm ±25%	100mA	0.85ohm max.	-55°C to +125°C	Kit
BLM18BD152SN1□	1500ohm ±25%	50mA	1.20ohm max.	-55°C to +125°C	Kit
BLM18BD182SN1□	1800ohm ±25%	50mA	1.50ohm max.	-55°C to +125°C	Kit
BLM18BD222SN1□	2200ohm ±25%	50mA	1.50ohm max.	-55°C to +125°C	Kit
BLM18BD252SN1□	2500ohm ±25%	50mA	1.50ohm max.	-55°C to +125°C	Kit
BLM18BB050SN1□	5ohm ±25%	700mA	0.05ohm max.	-55°C to +125°C	Kit
BLM18BB100SN1□	10ohm ±25%	700mA	0.10ohm max.	-55°C to +125°C	Kit
BLM18BB220SN1□	22ohm ±25%	600mA	0.20ohm max.	-55°C to +125°C	Kit
BLM18BB470SN1□	47ohm ±25%	550mA	0.25ohm max.	-55°C to +125°C	Kit
BLM18BB600SN1□	60ohm ±25%	550mA	0.25ohm max.	-55°C to +125°C	Kit
BLM18BB750SN1□	75ohm ±25%	500mA	0.30ohm max.	-55°C to +125°C	Kit
BLM18BB121SN1□	120ohm ±25%	500mA	0.30ohm max.	-55°C to +125°C	Kit
BLM18BB141SN1□	140ohm ±25%	450mA	0.35ohm max.	-55°C to +125°C	
BLM18BB151SN1□	150ohm ±25%	450mA	0.37ohm max.	-55°C to +125°C	Kit
BLM18BB221SN1□	220ohm ±25%	450mA	0.45ohm max.	-55°C to +125°C	Kit
BLM18BB331SN1□	330ohm ±25%	400mA	0.58ohm max.	-55°C to +125°C	Kit
BLM18BB471SN1□	470ohm ±25%	300mA	0.85ohm max.	-55°C to +125°C	Kit
BLM18BA050SN1□	5ohm ±25%	500mA	0.20ohm max.	-55°C to +125°C	Kit
BLM18BA100SN1□	10ohm ±25%	500mA	0.25ohm max.	-55°C to +125°C	Kit
BLM18BA220SN1□	22ohm ±25%	500mA	0.35ohm max.	-55°C to +125°C	
BLM18BA470SN1□	47ohm ±25%	300mA	0.55ohm max.	-55°C to +125°C	Kit
BLM18BA750SN1□	75ohm ±25%	300mA	0.70ohm max.	-55°C to +125°C	Kit
BLM18BA121SN1□	120ohm ±25%	200mA	0.90ohm max.	-55°C to +125°C	Kit

Number of Circuits: 1

Continued on the following page.

△Note • Please read rating and △CAUTION (for storage, operating, rating, soldering, mounting and handling) in this catalog to prevent smoking and/or burning, etc.
 • This catalog has only typical specifications. Therefore, please approve our product specifications or transact the approval sheet for product specifications before ordering.

Chip Ferrite Bead 0603 Size

Chip EMIFIL®

Chip Common Mode Choke Coil

Block Type EMIFIL®

Microwave Absorber

Impedance-Frequency Characteristics
 BLM18BD Series (47ohm to 420ohm)

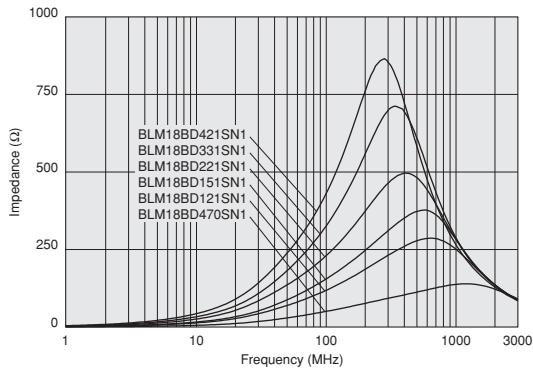

BLM18BD Series (470ohm to 2500ohm)

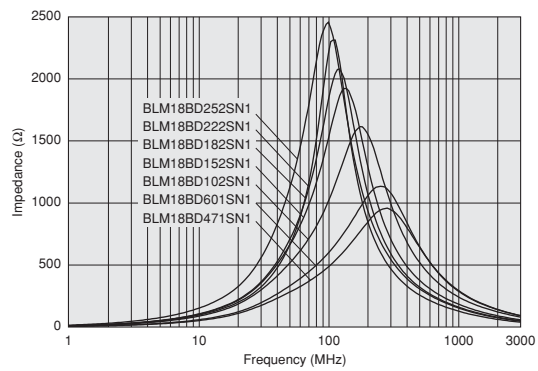

BLM18BB Series (5ohm to 75ohm)

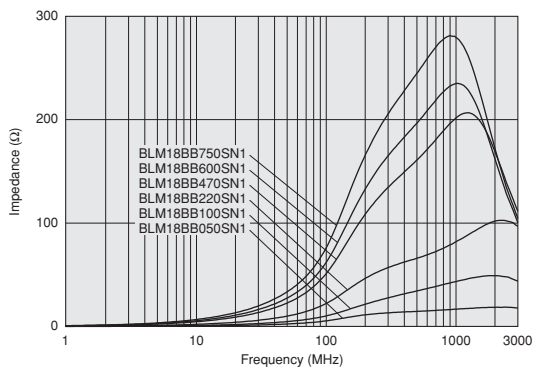

BLM18BB Series (120ohm to 470ohm)

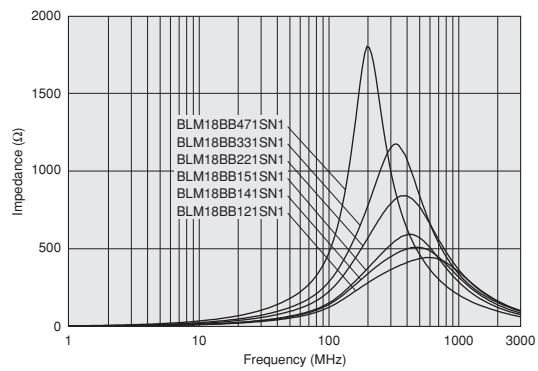

BLM18BA Series (5ohm to 220ohm)

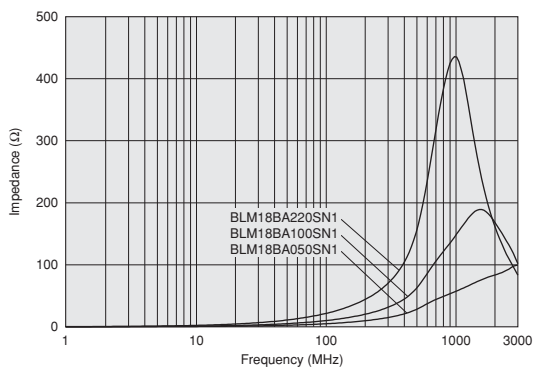

BLM18BA Series (47ohm to 120ohm)

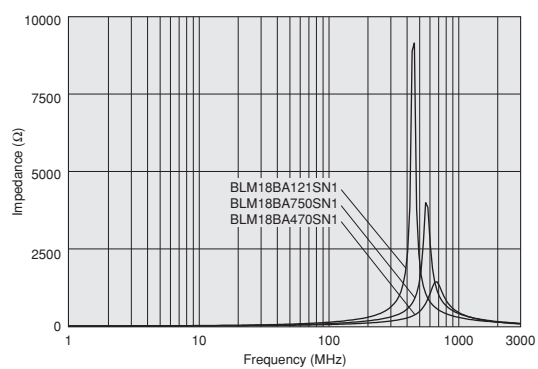

Impedance-Frequency Characteristics

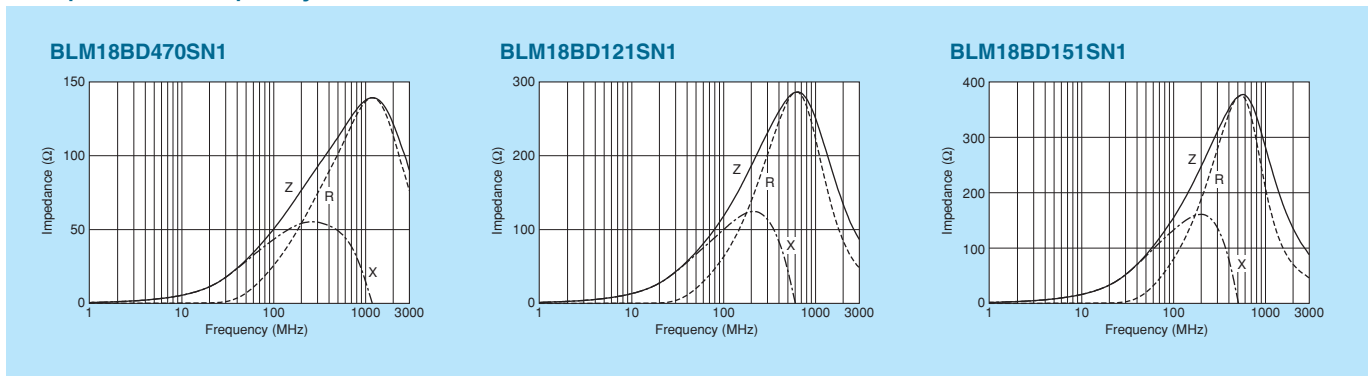

Continued on the following page.

Note • Please read rating and **CAUTION** (for storage, operating, rating, soldering, mounting and handling) in this catalog to prevent smoking and/or burning, etc.
 • This catalog has only typical specifications. Therefore, please approve our product specifications or transact the approval sheet for product specifications before ordering.

Impedance-Frequency Characteristics

Chip Ferrite Bead
 0603 Size

Chip EMIFIL®

Chip Common Mode Choke Coil

Block Type EMIFIL®

Microwave Absorber

BLM18BD221SN1

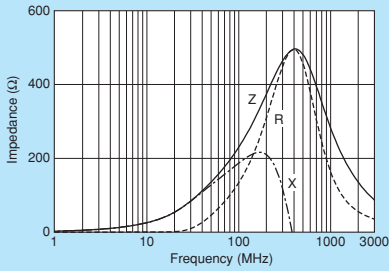

BLM18BD331SN1

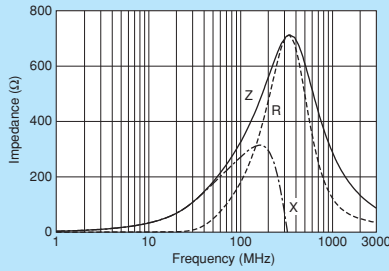

BLM18BD421SN1

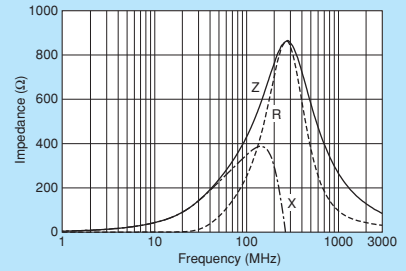

BLM18BD471SN1

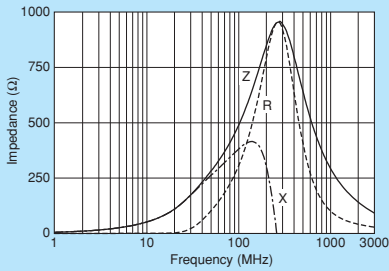

BLM18BD601SN1

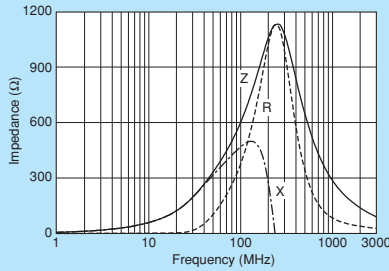

BLM18BD102SN1

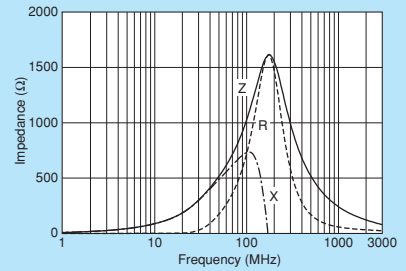

BLM18BD152SN1

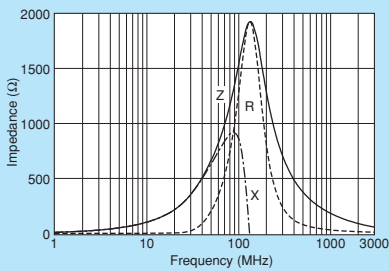

BLM18BD182SN1

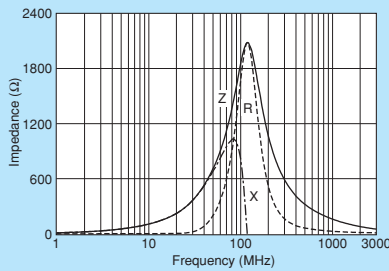

BLM18BD222SN1

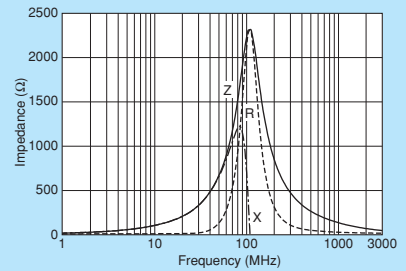

BLM18BD252SN1

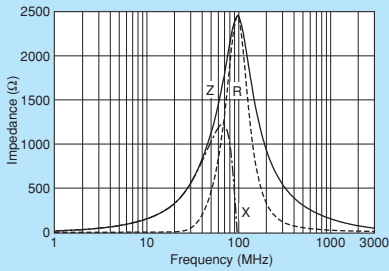

BLM18BB050SN1

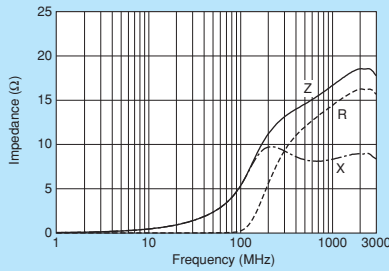

BLM18BB100SN1

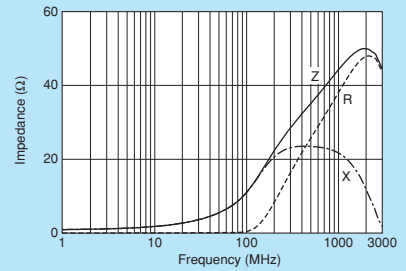

BLM18BB220SN1

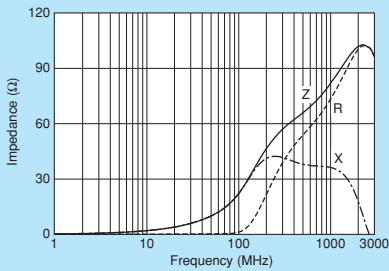

BLM18BB470SN1

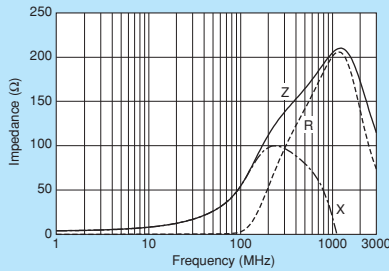

BLM18BB600SN1

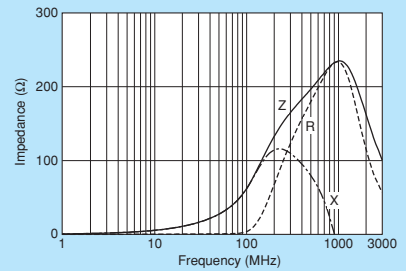

Continued on the following page.

△Note • Please read rating and △CAUTION (for storage, operating, rating, soldering, mounting and handling) in this catalog to prevent smoking and/or burning, etc.
 • This catalog has only typical specifications. Therefore, please approve our product specifications or transact the approval sheet for product specifications before ordering.

Impedance-Frequency Characteristics

BLM18BB750SN1

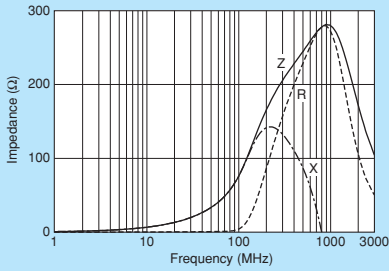

BLM18BB121SN1

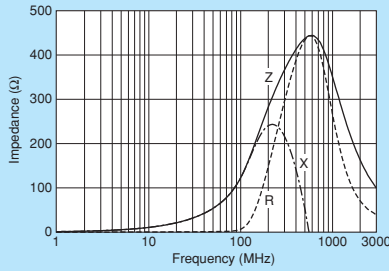

BLM18BB141SN1

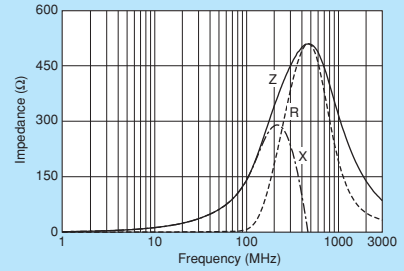

BLM18BB151SN1

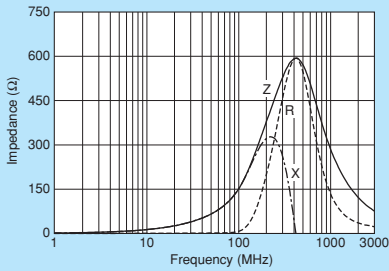

BLM18BB221SN1

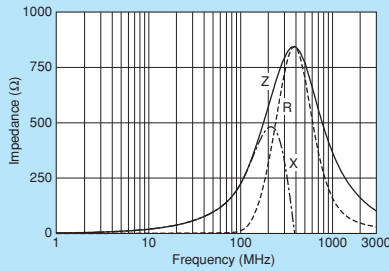

BLM18BB331SN1

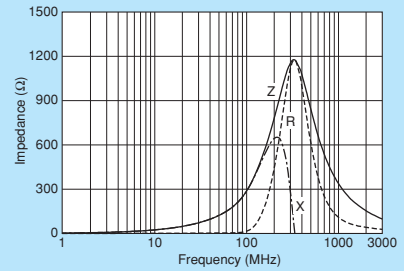

BLM18BB471SN1

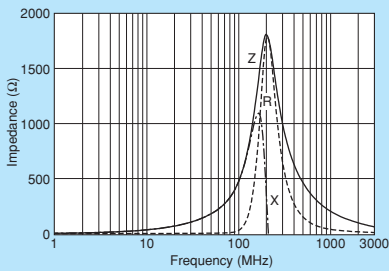

BLM18BA050SN1

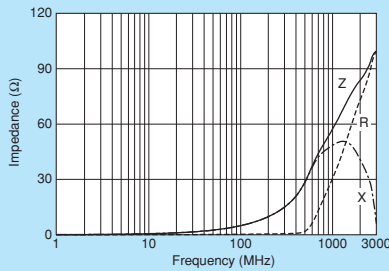

BLM18BA100SN1

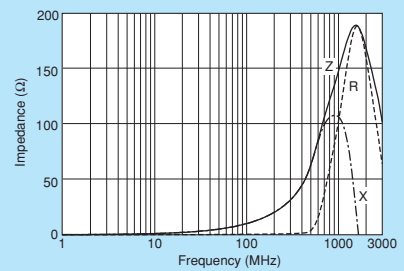

BLM18BA220SN1

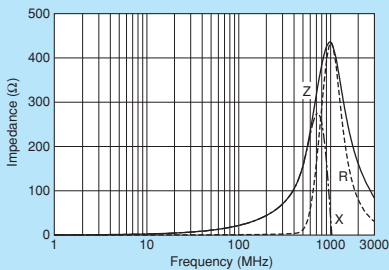

BLM18BA470SN1

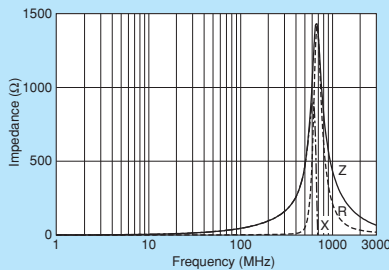

BLM18BA750SN1

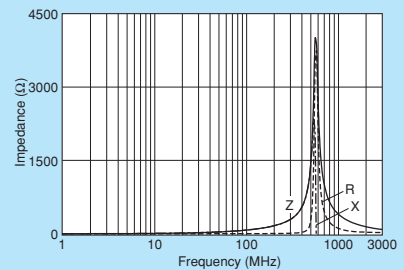

BLM18BA121SN1

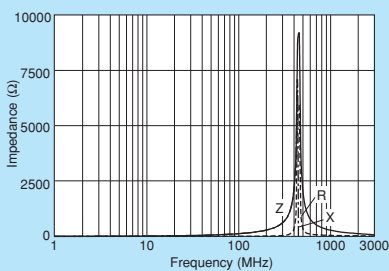

0603 Size
Chip Ferrite Bead

Chip EMIFIL®

Chip Common Mode Choke Coil

Block Type EMIFIL®

Microwave Absorber

⚠Note • Please read rating and ⚠CAUTION (for storage, operating, rating, soldering, mounting and handling) in this catalog to prevent smoking and/or burning, etc.
 • This catalog has only typical specifications. Therefore, please approve our product specifications or transact the approval sheet for product specifications before ordering.

BLM18T Series (0603 Size)



Thin 0603 size for general signal lines.

Chip Ferrite Bead
0603 Size

Chip EMIFIL®

Chip Common Mode Choke Coil

Block Type EMIFIL®

Microwave Absorber



■ Dimensions

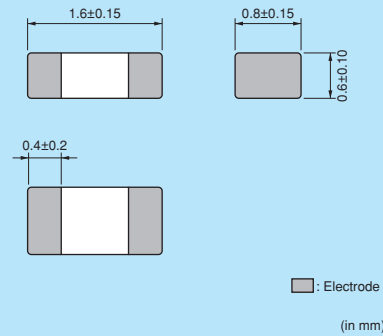

■ Equivalent Circuit



(Resistance element becomes dominant at high frequencies.)

■ Packaging

Code	Packaging	Minimum Quantity
D	180mm Reel Paper Tape	10000
B	Bulk (Bag)	1000

Refer to pages from p.97 to p.100 for mounting information.

■ Rated Value (□: packaging code)

Part Number	Impedance (at 100MHz/20°C)	Rated Current	DC Resistance	Operating Temperature Range
BLM18TG121TN1□	120ohm $\pm 25\%$	200mA	0.25ohm max.	-55°C to +125°C
BLM18TG221TN1□	220ohm $\pm 25\%$	200mA	0.30ohm max.	-55°C to +125°C
BLM18TG601TN1□	600ohm $\pm 25\%$	200mA	0.45ohm max.	-55°C to +125°C
BLM18TG102TN1□	1000ohm $\pm 25\%$	100mA	0.60ohm max.	-55°C to +125°C

Number of Circuits: 1

■ Impedance-Frequency Characteristics

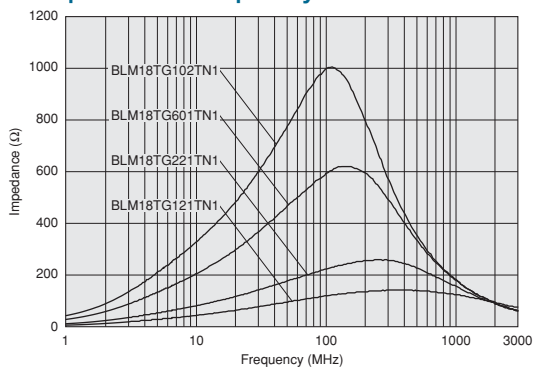

■ Impedance-Frequency Characteristics

BLM18TG121TN1

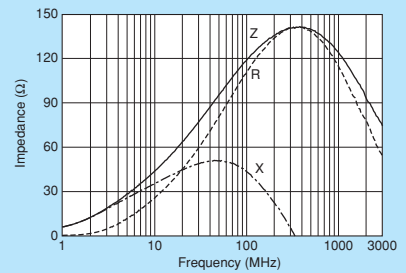

BLM18TG221TN1

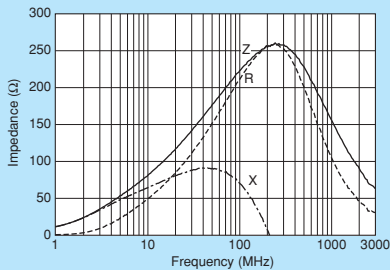

BLM18TG601TN1

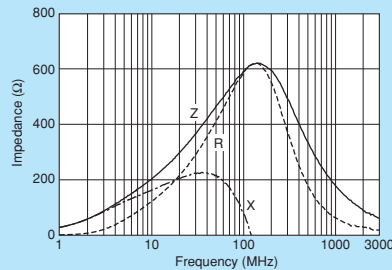

BLM18TG102TN1

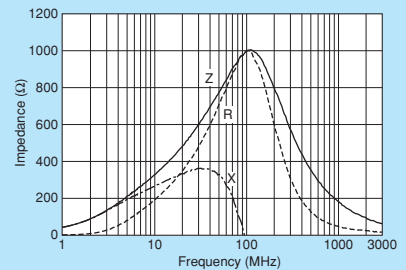

⚠ Note • Please read rating and ⚠ CAUTION (for storage, operating, rating, soldering, mounting and handling) in this catalog to prevent smoking and/or burning, etc.
 • This catalog has only typical specifications. Therefore, please approve our product specifications or transact the approval sheet for product specifications before ordering.

BLM18R Series (0603 Size)



For digital I/F. Reduces the distortion of waveform created by resonance.



■ Dimensions

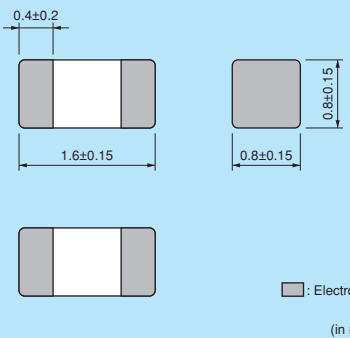

(in mm)

■ Equivalent Circuit



(Resistance element becomes dominant at high frequencies.)

■ Packaging

Code	Packaging	Minimum Quantity
D	180mm Reel Paper Tape	4000
J	330mm Reel Paper Tape	10000
B	Bulk(Bag)	1000

Refer to pages from p.97 to p.100 for mounting information.

■ Rated Value (□: packaging code)

Part Number	Impedance (at 100MHz/20°C)	Rated Current	DC Resistance	Operating Temperature Range	
BLM18RK121SN1□	120ohm ±25%	200mA	0.25ohm max.	-55°C to +125°C	Kit
BLM18RK221SN1□	220ohm ±25%	200mA	0.30ohm max.	-55°C to +125°C	
BLM18RK471SN1□	470ohm ±25%	200mA	0.50ohm max.	-55°C to +125°C	Kit
BLM18RK601SN1□	600ohm ±25%	200mA	0.60ohm max.	-55°C to +125°C	Kit
BLM18RK102SN1□	1000ohm ±25%	200mA	0.80ohm max.	-55°C to +125°C	Kit

Number of Circuits: 1

■ Impedance-Frequency Characteristics

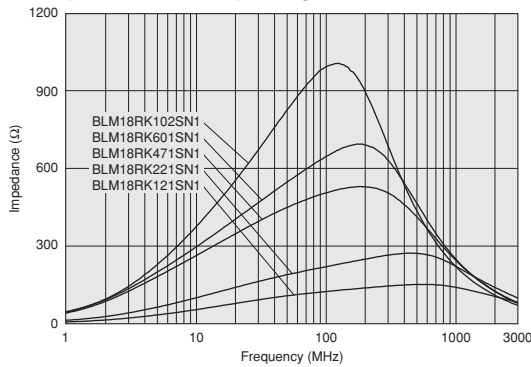

■ Impedance-Frequency Characteristics

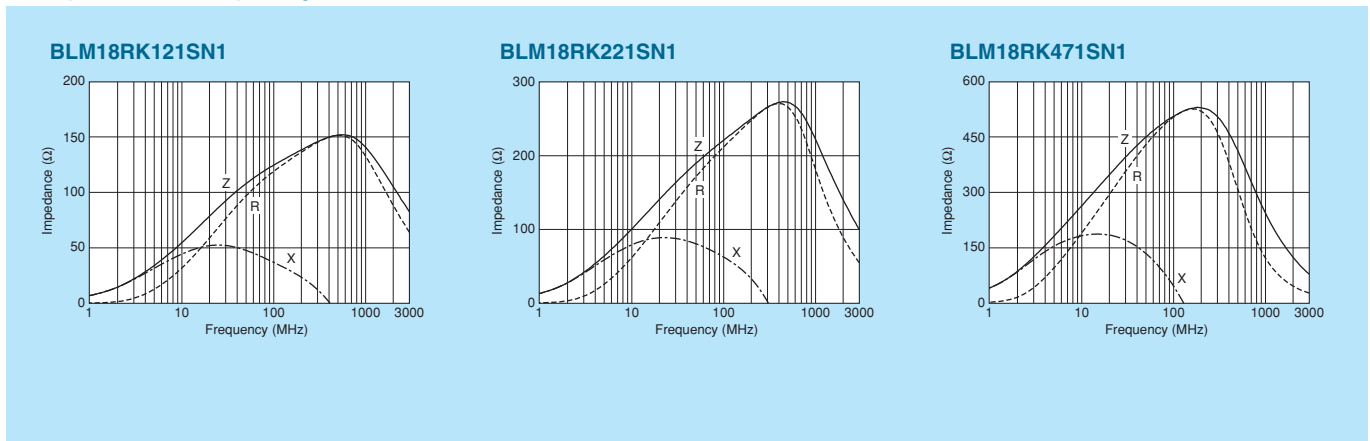

Continued on the following page.

⚠Note • Please read rating and ⚠CAUTION (for storage, operating, rating, soldering, mounting and handling) in this catalog to prevent smoking and/or burning, etc.
 • This catalog has only typical specifications. Therefore, please approve our product specifications or transact the approval sheet for product specifications before ordering.

■ Impedance-Frequency Characteristics

Chip Ferrite Bead
 0603 Size

Chip EMIFIL®

Chip Common Mode Choke Coil

Block Type EMIFIL®

Microwave Absorber

BLM18RK601SN1

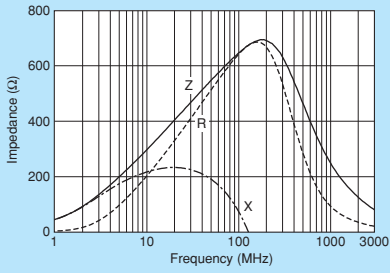

BLM18RK102SN1

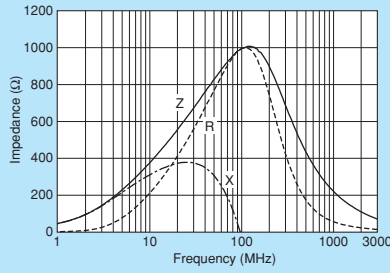

⚠Note • Please read rating and ⚠CAUTION (for storage, operating, rating, soldering, mounting and handling) in this catalog to prevent smoking and/or burning, etc.
 • This catalog has only typical specifications. Therefore, please approve our product specifications or transact the approval sheet for product specifications before ordering.

Waveform Distortion Suppressing Performance of BLM□□R Series

Measuring Circuits

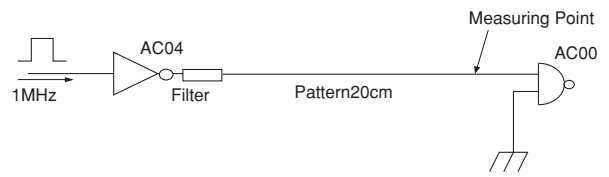

Type of Filter	EMI Suppression Effect / Description		
Initial (No filter)	<p>Signal waveform (100nsec/div, 2V/div)</p>	<p>Expand (10nsec/div, 2V/div)</p>	<p>Spectrum</p>
	<p>Ringing is caused on the signal waveform. Such ringing contains several hundred MHz harmonic components and generates noise.</p>		
	Resistor (47Ω) is used	<p>Signal waveform (100nsec/div, 2V/div)</p>	<p>Expand (10nsec/div, 2V/div)</p>
<p>Comparing initial waveform, ringing is suppressed a little. However, high level waveform distortion still remains.</p>			
BLM18RK221SN1 (220Ω at 100MHz) is used		<p>Signal waveform (100nsec/div, 2V/div)</p>	<p>Expand (10nsec/div, 2V/div)</p>
	<p>BLM18R has excellent performance for noise suppression and waveform distortion suppression. BLM18R suppresses drastically not only the spectrum level in more than 100MHz range but waveform distortion.</p>		

△Note • Please read rating and △CAUTION (for storage, operating, rating, soldering, mounting and handling) in this catalog to prevent smoking and/or burning, etc.
• This catalog has only typical specifications. Therefore, please approve our product specifications or transact the approval sheet for product specifications before ordering.

BLM21P Series (0805 Size)



0805 size for power lines.

*Please refer to the products designed for both power lines and signal lines. *Please refer to BLM18K for downsizing.

Chip Ferrite Bead
0805 Size

Chip EMIFIL®

Chip Common Mode Choke Coil

Block Type EMIFIL®

Microwave Absorber



■ Dimensions

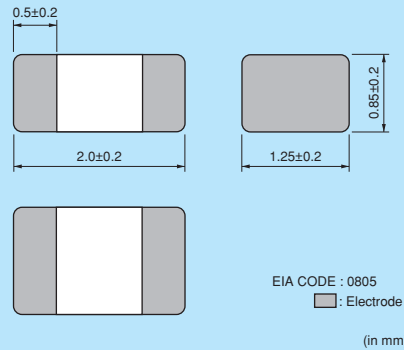

■ Equivalent Circuit

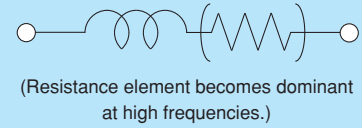

■ Packaging

Code	Packaging	Minimum Quantity
D	180mm Reel Paper Tape	4000
J	330mm Reel Paper Tape	10000
B	Bulk(Bag)	1000

Refer to pages from p.97 to p.100 for mounting information.

■ Rated Value (□: packaging code)

Part Number	Impedance (at 100MHz/20°C)	Rated Current	DC Resistance	Operating Temperature Range	Kit	Current
BLM21PG220SN1□	22ohm ±25%	6000mA	0.009ohm max.	-55°C to +125°C	Kit	≥3A
BLM21PG300SN1□	30ohm (Typ.)	4000mA	0.014ohm max.	-55°C to +125°C	Kit	≥3A
BLM21PG600SN1□	60ohm ±25%	3500mA	0.02ohm max.	-55°C to +125°C	Kit	≥3A
BLM21PG121SN1□	120ohm ±25%	3000mA	0.03ohm max.	-55°C to +125°C	Kit	≥3A
BLM21PG221SN1□	220ohm ±25%	2000mA	0.045ohm max.	-55°C to +125°C	Kit	≥1A
BLM21PG331SN1□	330ohm ±25%	1500mA	0.07ohm max.	-55°C to +125°C	Kit	≥1A

Number of Circuits: 1

■ Impedance-Frequency Characteristics

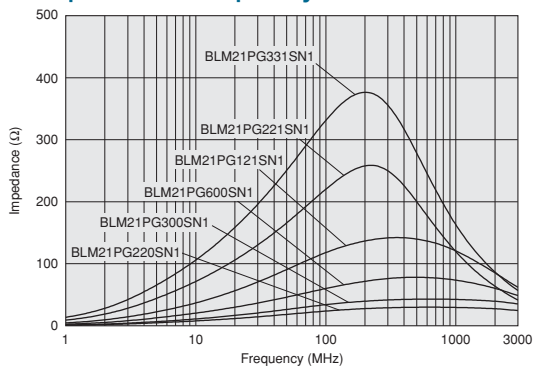

■ Notice (Rating)

In operating temperature exceeding +85°C, derating of current is necessary for BLM21PG series.

Please apply the derating curve shown in chart according to the operating temperature.

Derating of Rated Current

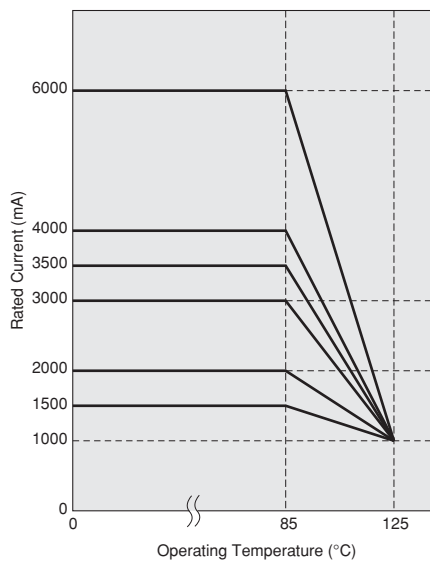

Continued on the following page.

△Note • Please read rating and △CAUTION (for storage, operating, rating, soldering, mounting and handling) in this catalog to prevent smoking and/or burning, etc.
• This catalog has only typical specifications. Therefore, please approve our product specifications or transact the approval sheet for product specifications before ordering.

Impedance-Frequency Characteristics

BLM21PG220SN1

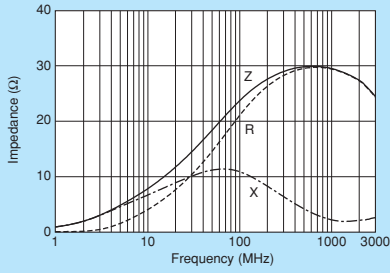

BLM21PG300SN1

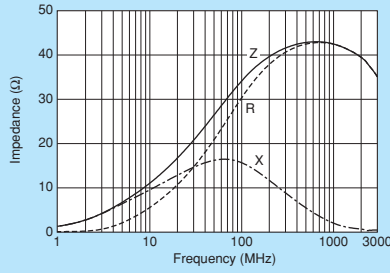

BLM21PG600SN1

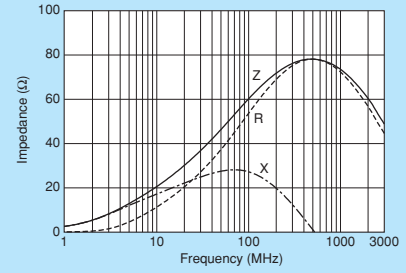

BLM21PG121SN1

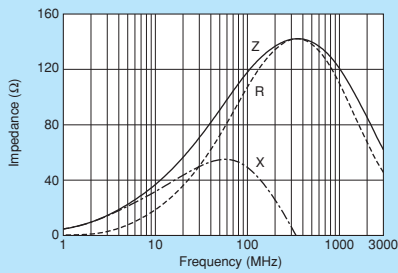

BLM21PG221SN1

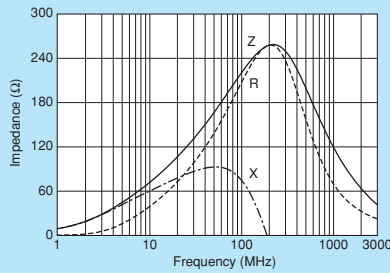

BLM21PG331SN1

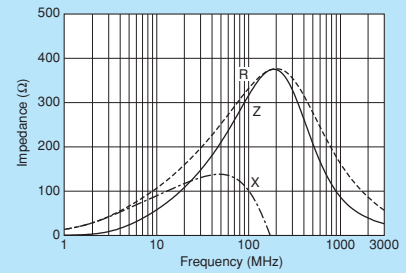

0805 Size
Chip Ferrite Bead

Chip EMIFIL®

Chip Common Mode Choke Coil

Block Type EMIFIL®

Microwave Absorber

⚠Note • Please read rating and ⚠CAUTION (for storage, operating, rating, soldering, mounting and handling) in this catalog to prevent smoking and/or burning, etc.
 • This catalog has only typical specifications. Therefore, please approve our product specifications or transact the approval sheet for product specifications before ordering.

BLM21A Series (0805 Size)



0805 size for general signal lines.

Chip Ferrite Bead
0805 Size

Chip EMIFIL®

Chip Common Mode Choke Coil

Block Type EMIFIL®

Microwave Absorber



Dimensions

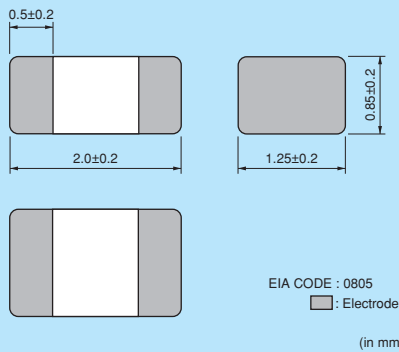

Equivalent Circuit

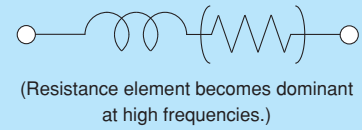

Packaging

Code	Packaging	Minimum Quantity
D	180mm Reel Paper Tape	4000
J	330mm Reel Paper Tape	10000
B	Bulk(Bag)	1000

Refer to pages from p.97 to p.100 for mounting information.

Rated Value (□: packaging code)

Part Number	Impedance (at 100MHz/20°C)	Rated Current	DC Resistance	Operating Temperature Range	
BLM21AG121SN1□	120ohm ±25%	800mA	0.10ohm max.	-55°C to +125°C	Kit
BLM21AG151SN1□	150ohm ±25%	800mA	0.10ohm max.	-55°C to +125°C	Kit
BLM21AG221SN1□	220ohm ±25%	800mA	0.13ohm max.	-55°C to +125°C	Kit
BLM21AG331SN1□	330ohm ±25%	700mA	0.16ohm max.	-55°C to +125°C	Kit
BLM21AG471SN1□	470ohm ±25%	700mA	0.19ohm max.	-55°C to +125°C	Kit
BLM21AG601SN1□	600ohm ±25%	600mA	0.21ohm max.	-55°C to +125°C	Kit
BLM21AG102SN1□	1000ohm ±25%	500mA	0.28ohm max.	-55°C to +125°C	Kit

Number of Circuits: 1

Impedance-Frequency Characteristics

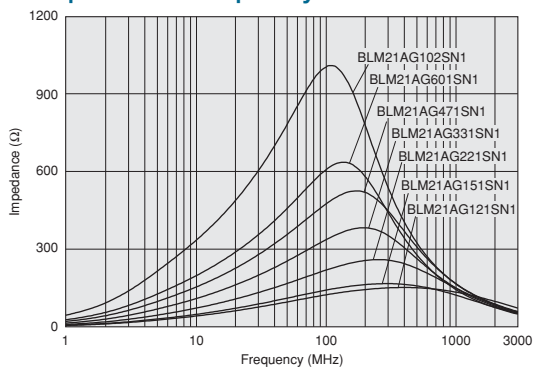

Impedance-Frequency Characteristics

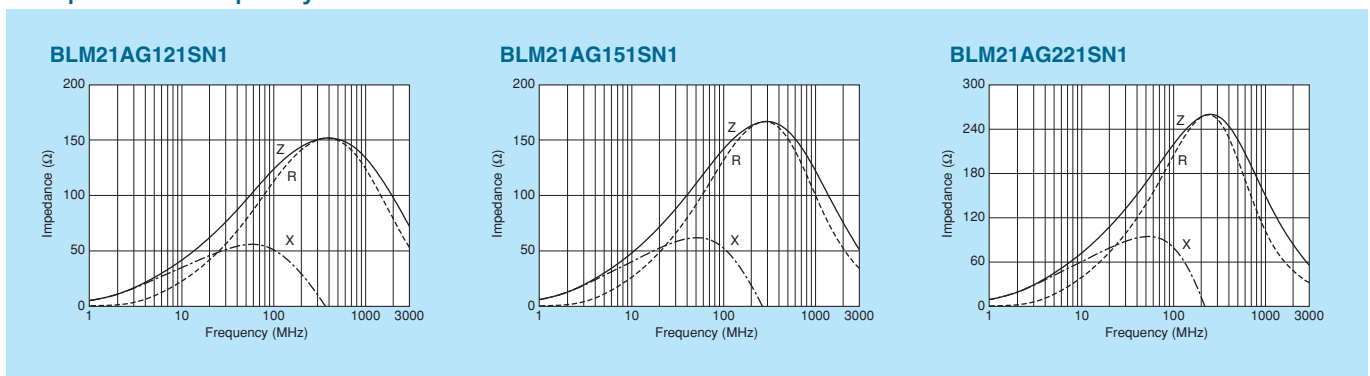

Continued on the following page. ↗

△Note • Please read rating and △CAUTION (for storage, operating, rating, soldering, mounting and handling) in this catalog to prevent smoking and/or burning, etc.
• This catalog has only typical specifications. Therefore, please approve our product specifications or transact the approval sheet for product specifications before ordering.

Impedance-Frequency Characteristics

BLM21AG331SN1

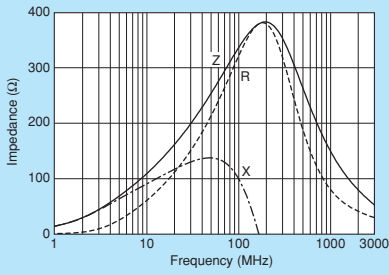

BLM21AG471SN1

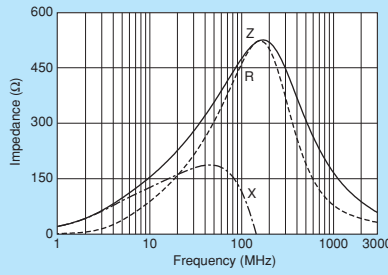

BLM21AG601SN1

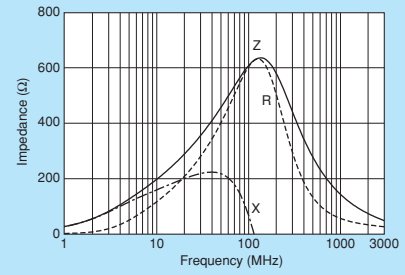

BLM21AG102SN1

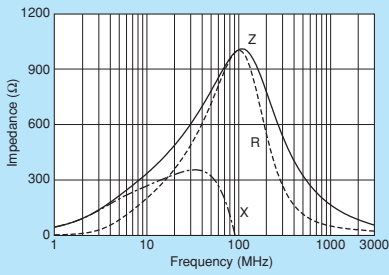

0805 Size
Chip Ferrite Bead

Chip EMIFIL®

Chip Common Mode Choke Coil

Block Type EMIFIL®

Microwave Absorber

⚠Note • Please read rating and ⚠CAUTION (for storage, operating, rating, soldering, mounting and handling) in this catalog to prevent smoking and/or burning, etc.
 • This catalog has only typical specifications. Therefore, please approve our product specifications or transact the approval sheet for product specifications before ordering.

BLM21B Series (0805 Size)



0805 size for high speed signal lines.



■ Dimensions

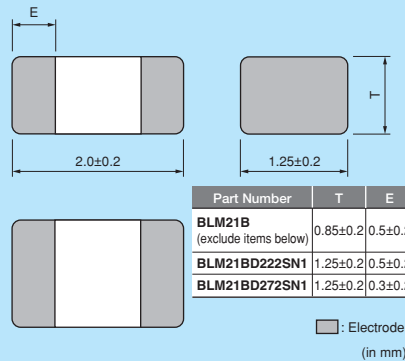

■ Equivalent Circuit

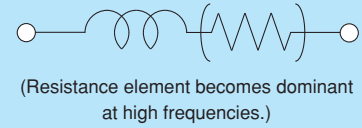

■ Packaging

• All except for BLM21BD222SN1/21BD272SN1

Code	Packaging	Minimum Quantity
D	180mm Reel Paper Tape	4000
J	330mm Reel Paper Tape	10000
B	Bulk(Bag)	1000

• BLM21BD222SN1/21BD272SN1 only

Code	Packaging	Minimum Quantity
L	180mm Reel Plastic Tape	3000
K	330mm Reel Plastic Tape	10000
B	Bulk(Bag)	1000

Refer to pages from p.97 to p.100 for mounting information.

■ Rated Value (□: packaging code)

Part Number	Impedance (at 100MHz/20°C)	Rated Current	DC Resistance	Operating Temperature Range	
BLM21BD121SN1□	120ohm ±25%	200mA	0.25ohm max.	-55°C to +125°C	Kit
BLM21BD151SN1□	150ohm ±25%	200mA	0.25ohm max.	-55°C to +125°C	
BLM21BD221SN1□	220ohm ±25%	200mA	0.25ohm max.	-55°C to +125°C	Kit
BLM21BD331SN1□	330ohm ±25%	200mA	0.30ohm max.	-55°C to +125°C	
BLM21BD421SN1□	420ohm ±25%	200mA	0.30ohm max.	-55°C to +125°C	Kit
BLM21BD471SN1□	470ohm ±25%	200mA	0.35ohm max.	-55°C to +125°C	Kit
BLM21BD601SN1□	600ohm ±25%	200mA	0.35ohm max.	-55°C to +125°C	Kit
BLM21BD751SN1□	750ohm ±25%	200mA	0.40ohm max.	-55°C to +125°C	
BLM21BD102SN1□	1000ohm ±25%	200mA	0.40ohm max.	-55°C to +125°C	Kit
BLM21BD152SN1□	1500ohm ±25%	200mA	0.45ohm max.	-55°C to +125°C	Kit
BLM21BD182SN1□	1800ohm ±25%	200mA	0.50ohm max.	-55°C to +125°C	Kit
BLM21BD222TN1□	2200ohm ±25%	200mA	0.60ohm max.	-55°C to +125°C	Kit
BLM21BD222SN1□	2250ohm (Typ.)	200mA	0.60ohm max.	-55°C to +125°C	Kit
BLM21BD272SN1□	2700ohm ±25%	200mA	0.80ohm max.	-55°C to +125°C	Kit
BLM21BB050SN1□	5ohm ±25%	1000mA	0.02ohm max.	-55°C to +125°C	Kit
BLM21BB600SN1□	60ohm ±25%	800mA	0.13ohm max.	-55°C to +125°C	Kit
BLM21BB750SN1□	75ohm ±25%	700mA	0.16ohm max.	-55°C to +125°C	Kit
BLM21BB121SN1□	120ohm ±25%	600mA	0.19ohm max.	-55°C to +125°C	Kit
BLM21BB151SN1□	150ohm ±25%	600mA	0.21ohm max.	-55°C to +125°C	
BLM21BB201SN1□	200ohm ±25%	500mA	0.26ohm max.	-55°C to +125°C	
BLM21BB221SN1□	220ohm ±25%	500mA	0.26ohm max.	-55°C to +125°C	Kit
BLM21BB331SN1□	330ohm ±25%	400mA	0.33ohm max.	-55°C to +125°C	Kit
BLM21BB471SN1□	470ohm ±25%	400mA	0.40ohm max.	-55°C to +125°C	Kit

Number of Circuits: 1

Continued on the following page. ↗

△Note • Please read rating and △CAUTION (for storage, operating, rating, soldering, mounting and handling) in this catalog to prevent smoking and/or burning, etc.
• This catalog has only typical specifications. Therefore, please approve our product specifications or transact the approval sheet for product specifications before ordering.

Chip Ferrite Bead
0805 Size

Chip EMIFIL®

Chip Common Mode Choke Coil

Block Type EMIFIL®

Microwave Absorber

Impedance-Frequency Characteristics

BLM21BD Series

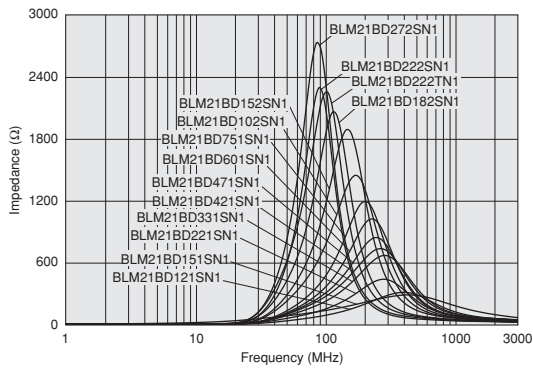

BLM21BB Series

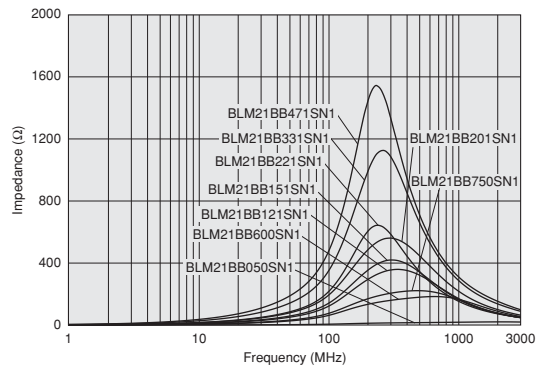

Impedance-Frequency Characteristics

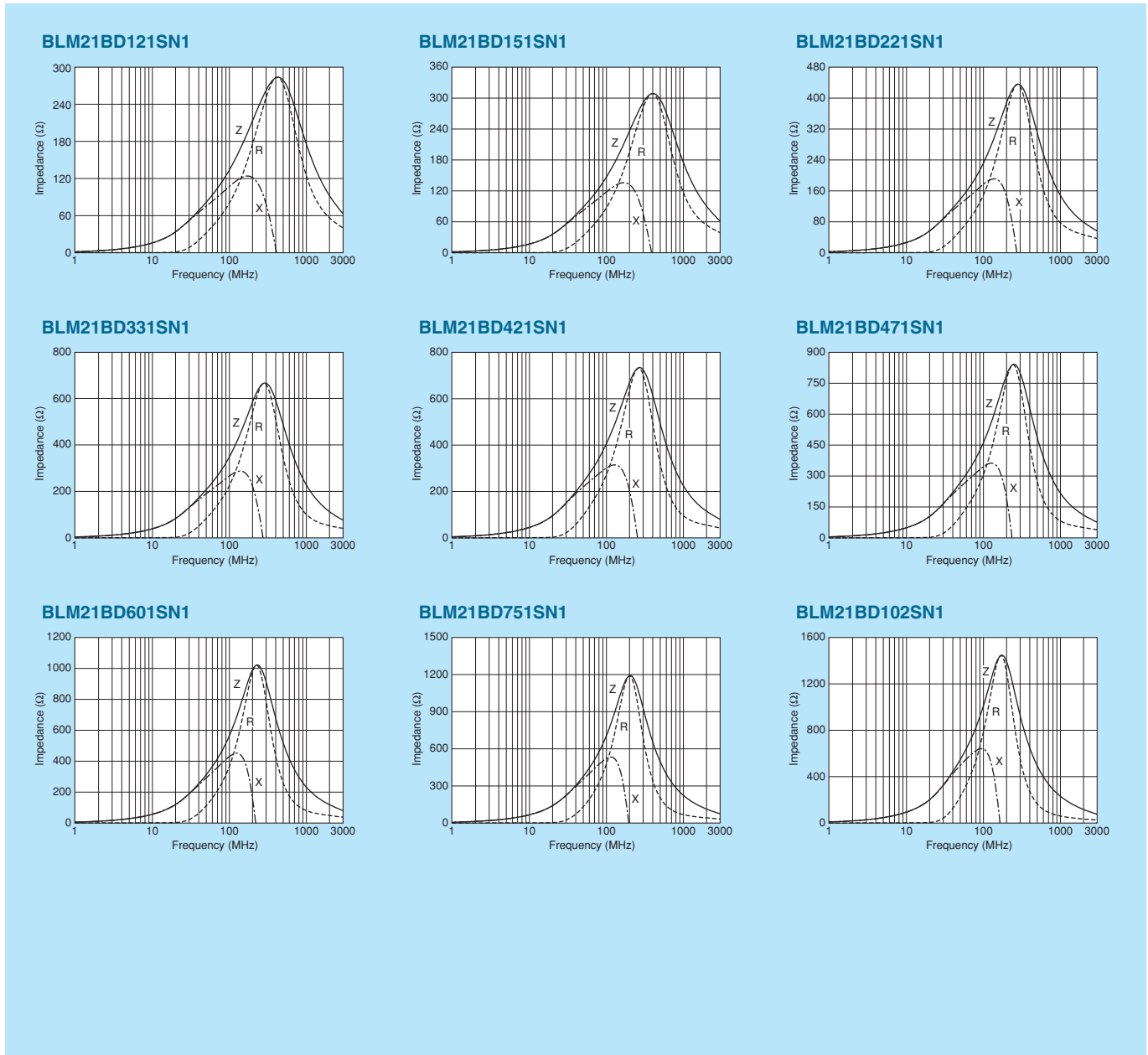

Continued on the following page.

Note • Please read rating and **CAUTION** (for storage, operating, rating, soldering, mounting and handling) in this catalog to prevent smoking and/or burning, etc.
 • This catalog has only typical specifications. Therefore, please approve our product specifications or transact the approval sheet for product specifications before ordering.

Impedance-Frequency Characteristics

Chip Ferrite Bead
 0805 Size

Chip EMIFIL®

Chip Common Mode Choke Coil

Block Type EMIFIL®

Microwave Absorber

BLM21BD152SN1

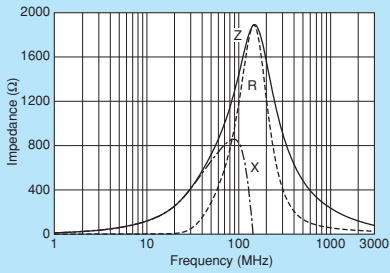

BLM21BD182SN1

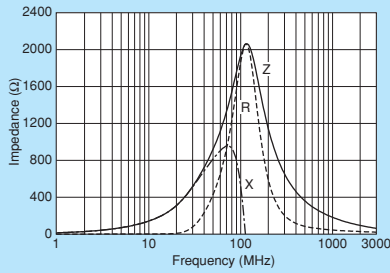

BLM21BD222TN1

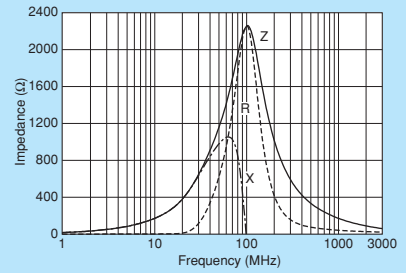

BLM21BD222SN1

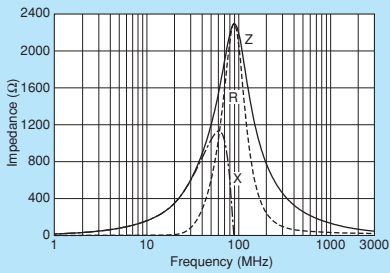

BLM21BD272SN1

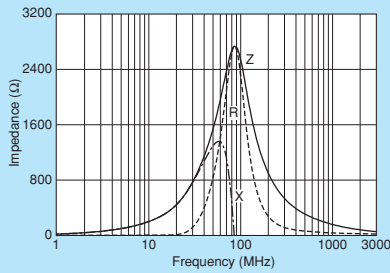

BLM21BB050SN1

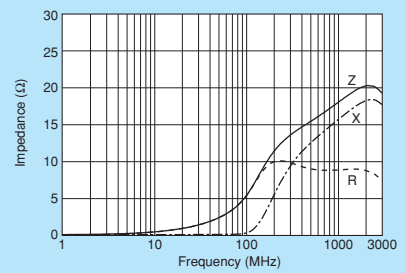

BLM21BB600SN1

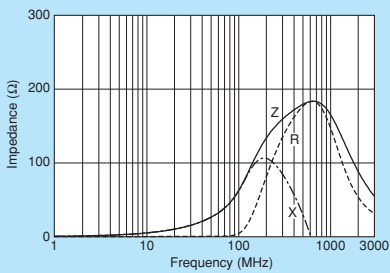

BLM21BB750SN1

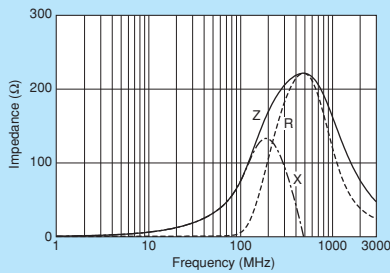

BLM21BB121SN1

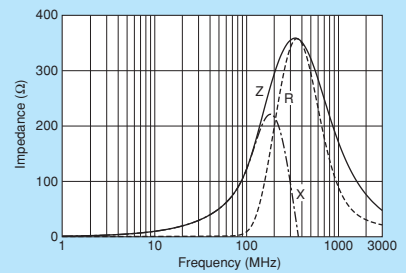

BLM21BB151SN1

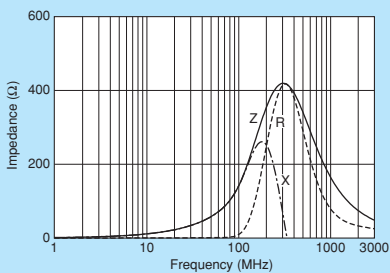

BLM21BB201SN1

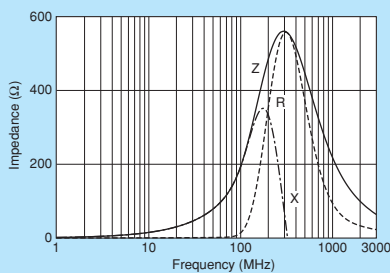

BLM21BB221SN1

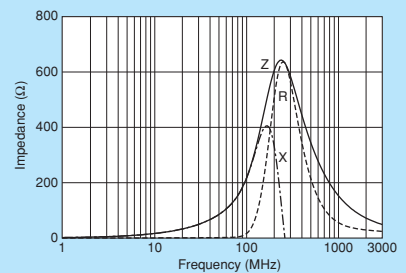

BLM21BB331SN1

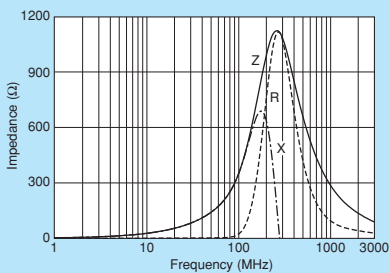

BLM21BB471SN1

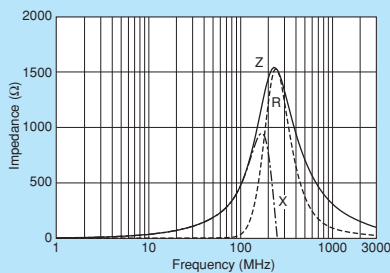

△Note • Please read rating and △CAUTION (for storage, operating, rating, soldering, mounting and handling) in this catalog to prevent smoking and/or burning, etc.
 • This catalog has only typical specifications. Therefore, please approve our product specifications or transact the approval sheet for product specifications before ordering.

BLM21R Series (0805 Size)



For digital I/F. Reduces the distortion of waveform created by resonance.



■ Dimensions

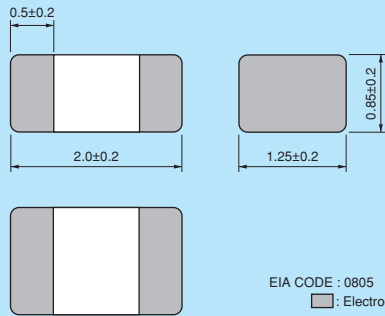

EIA CODE : 0805
 Electrode
 (in mm)

■ Equivalent Circuit



(Resistance element becomes dominant at high frequencies.)

■ Packaging

Code	Packaging	Minimum Quantity
D	180mm Reel Paper Tape	4000
J	330mm Reel Paper Tape	10000
B	Bulk(Bag)	1000

Refer to pages from p.97 to p.100 for mounting information.

■ Rated Value (□: packaging code)

Part Number	Impedance (at 100MHz/20°C)	Rated Current	DC Resistance	Operating Temperature Range
BLM21RK121SN1□	120ohm ±25%	200mA	0.15ohm max.	-55°C to +125°C
BLM21RK221SN1□	220ohm ±25%	200mA	0.20ohm max.	-55°C to +125°C
BLM21RK471SN1□	470ohm ±25%	200mA	0.25ohm max.	-55°C to +125°C
BLM21RK601SN1□	600ohm ±25%	200mA	0.30ohm max.	-55°C to +125°C
BLM21RK102SN1□	1000ohm ±25%	200mA	0.50ohm max.	-55°C to +125°C

Number of Circuits: 1

■ Impedance-Frequency Characteristics

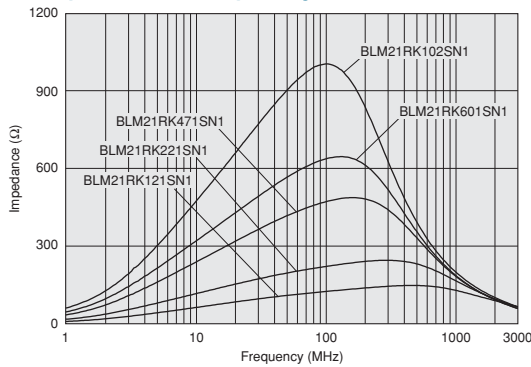

■ Impedance-Frequency Characteristics

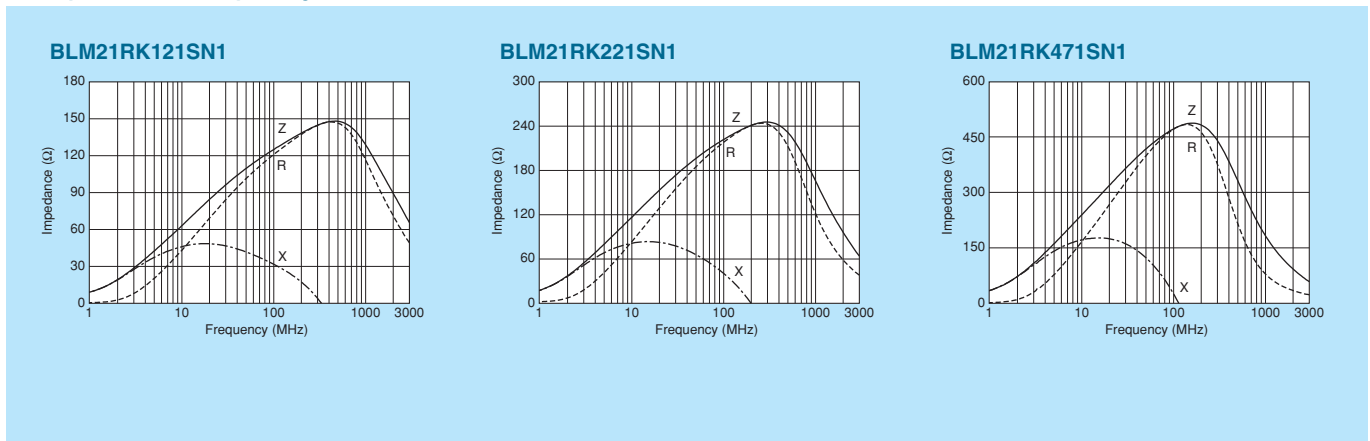

Continued on the following page.

⚠Note • Please read rating and ⚠CAUTION (for storage, operating, rating, soldering, mounting and handling) in this catalog to prevent smoking and/or burning, etc.
 • This catalog has only typical specifications. Therefore, please approve our product specifications or transact the approval sheet for product specifications before ordering.

Impedance-Frequency Characteristics

BLM21RK601SN1

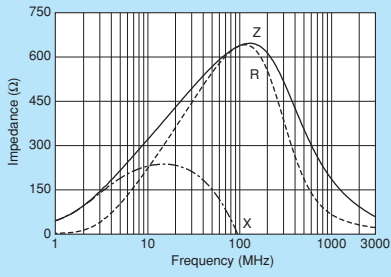

BLM21RK102SN1

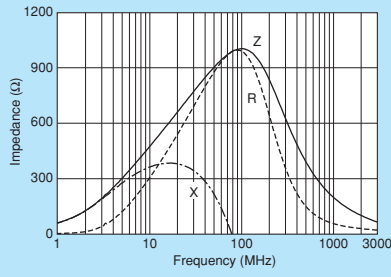

⚠Note • Please read rating and ⚠CAUTION (for storage, operating, rating, soldering, mounting and handling) in this catalog to prevent smoking and/or burning, etc.
 • This catalog has only typical specifications. Therefore, please approve our product specifications or transact the approval sheet for product specifications before ordering.

Chip Ferrite Bead 0805 Size
 Chip EMIFIL®
 Chip Common Mode Choke Coil
 Block Type EMIFIL®
 Microwave Absorber

BLM31P Series (1206 Size)



1206 size for power lines.

*Please refer to the products designed for both power lines and signal lines.



■ Dimensions

(in mm)

■ Equivalent Circuit



(Resistance element becomes dominant at high frequencies.)

■ Packaging

Code	Packaging	Minimum Quantity
L	180mm Reel Embossed Tape	3000
K	330mm Reel Embossed Tape	10000
B	Bulk(Bag)	1000

Refer to pages from p.97 to p.100 for mounting information.

■ Rated Value (□: packaging code)

Part Number	Impedance (at 100MHz/20°C)	Rated Current	DC Resistance	Operating Temperature Range	Kit	≥3A
BLM31PG330SN1□	33ohm ±25%	6000mA	0.009ohm max.	-55°C to +125°C	Kit	≥3A
BLM31PG500SN1□	50ohm (Typ.)	3500mA	0.015ohm max.	-55°C to +125°C	Kit	≥3A
BLM31PG121SN1□	120ohm ±25%	3500mA	0.02ohm max.	-55°C to +125°C	Kit	≥3A
BLM31PG391SN1□	390ohm ±25%	2000mA	0.05ohm max.	-55°C to +125°C	Kit	≥1A
BLM31PG601SN1□	600ohm ±25%	1500mA	0.08ohm max.	-55°C to +125°C	Kit	≥1A

Number of Circuits: 1

■ Impedance-Frequency Characteristics

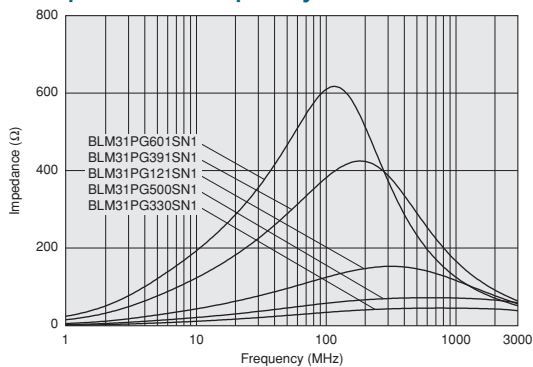

■ Notice (Rating)

In operating temperature exceeding +85°C, derating of current is necessary for BLM31PG series.

Please apply the derating curve shown in chart according to the operating temperature.

Derating of Rated Current

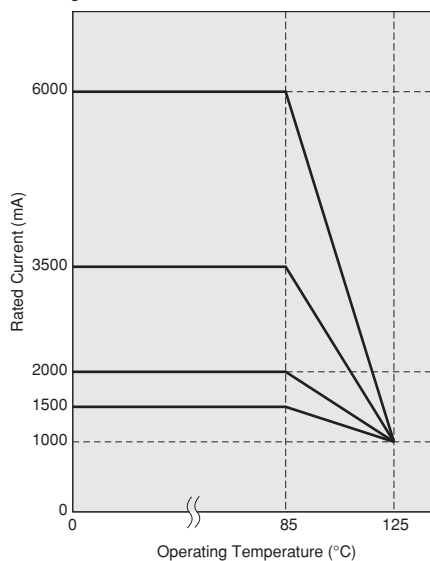

Continued on the following page.

△Note • Please read rating and ⚠CAUTION (for storage, operating, rating, soldering, mounting and handling) in this catalog to prevent smoking and/or burning, etc.
 • This catalog has only typical specifications. Therefore, please approve our product specifications or transact the approval sheet for product specifications before ordering.

Impedance-Frequency Characteristics

BLM31PG330SN1

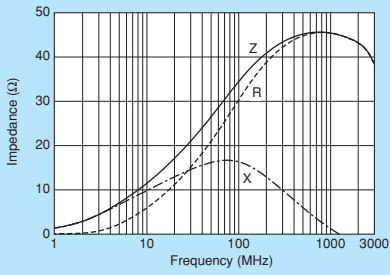

BLM31PG500SN1

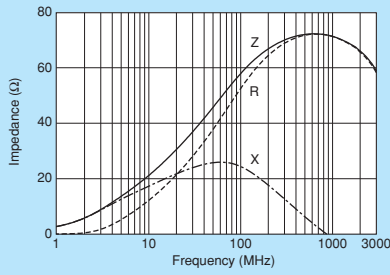

BLM31PG121SN1

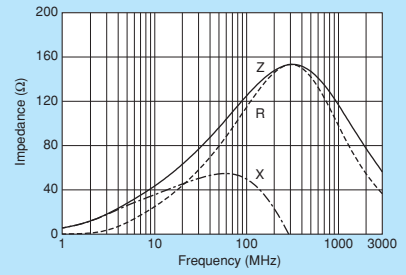

BLM31PG391SN1

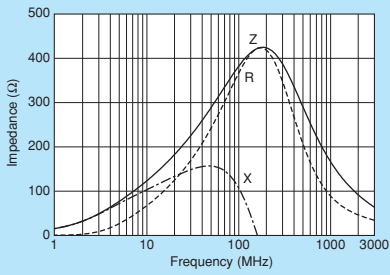

BLM31PG601SN1

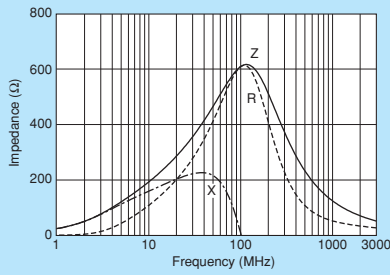

⚠Note • Please read rating and ⚠CAUTION (for storage, operating, rating, soldering, mounting and handling) in this catalog to prevent smoking and/or burning, etc.
 • This catalog has only typical specifications. Therefore, please approve our product specifications or transact the approval sheet for product specifications before ordering.

Chip Ferrite Bead
 1206 Size

Chip EMIFIL®

Chip Common Mode Choke Coil

Block Type EMIFIL®

Microwave Absorber

BLM41P Series (1806 Size)



1806 size for power lines.

*Please refer to the products designed for both power lines and signal lines.



■ Dimensions

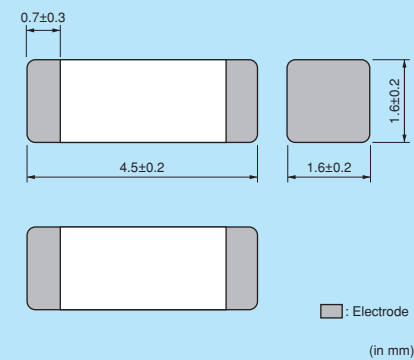

(in mm)

■ Equivalent Circuit



(Resistance element becomes dominant at high frequencies.)

■ Packaging

Code	Packaging	Minimum Quantity
L	180mm Reel Embossed Tape	2500
K	330mm Reel Embossed Tape	8000
B	Bulk(Bag)	1000

Refer to pages from p.97 to p.100 for mounting information.

■ Rated Value (□: packaging code)

Part Number	Impedance (at 100MHz/20°C)	Rated Current	DC Resistance	Operating Temperature Range	Kit	Current
BLM41PG600SN1□	60ohm (Typ.)	6000mA	0.009ohm max.	-55°C to +125°C	Kit	≥3A
BLM41PG750SN1□	75ohm (Typ.)	3500mA	0.015ohm max.	-55°C to +125°C	Kit	≥3A
BLM41PG181SN1□	180ohm ±25%	3500mA	0.02ohm max.	-55°C to +125°C	Kit	≥3A
BLM41PG471SN1□	470ohm ±25%	2000mA	0.05ohm max.	-55°C to +125°C	Kit	≥1A
BLM41PG102SN1□	1000ohm ±25%	1500mA	0.09ohm max.	-55°C to +125°C	Kit	≥1A

Number of Circuits: 1

■ Impedance-Frequency Characteristics BLM41PG Series (60ohm to 75ohm)

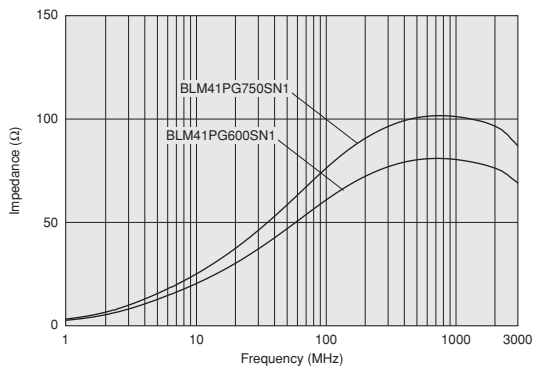

■ Impedance-Frequency Characteristics BLM41PG Series (180ohm to 1000ohm)

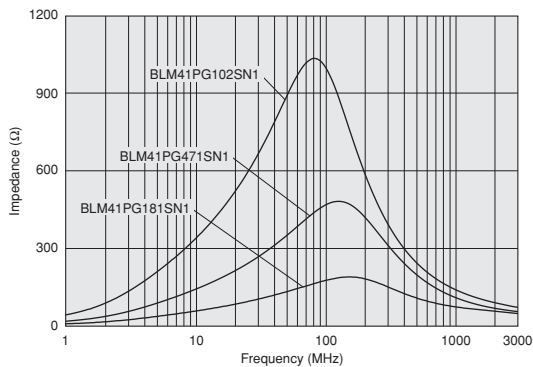

■ Notice (Rating)

In operating temperature exceeding +85°C, derating of current is necessary for BLM41PG series.

Please apply the derating curve shown in chart according to the operating temperature.

Derating of Rated Current

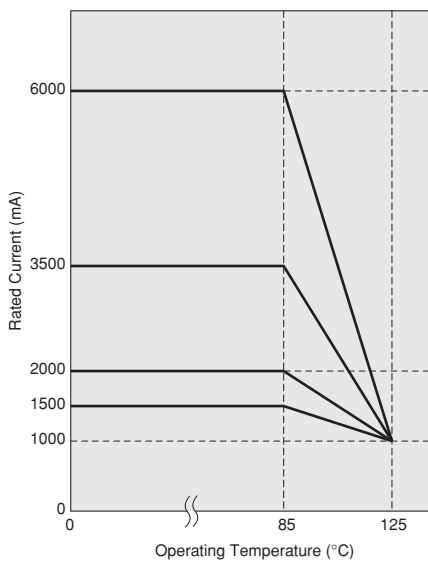

Continued on the following page.

△Note • Please read rating and △CAUTION (for storage, operating, rating, soldering, mounting and handling) in this catalog to prevent smoking and/or burning, etc.
 • This catalog has only typical specifications. Therefore, please approve our product specifications or transact the approval sheet for product specifications before ordering.

Impedance-Frequency Characteristics

BLM41PG600SN1

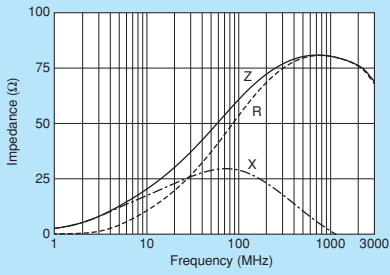

BLM41PG750SN1

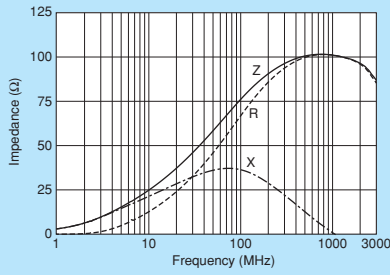

BLM41PG181SN1

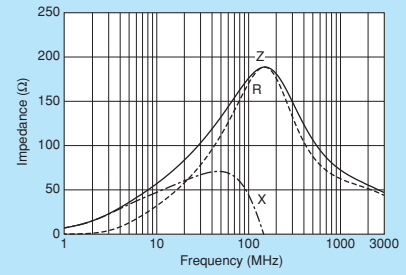

BLM41PG471SN1

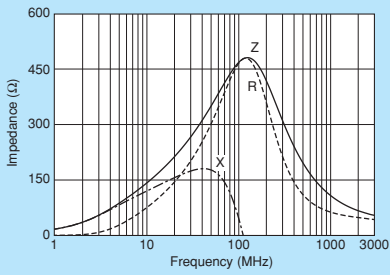

BLM41PG102SN1

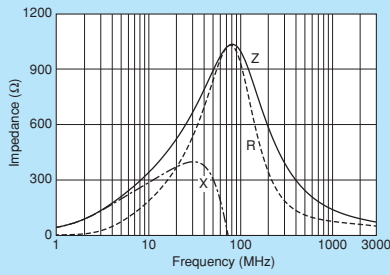

⚠Note • Please read rating and ⚠CAUTION (for storage, operating, rating, soldering, mounting and handling) in this catalog to prevent smoking and/or burning, etc.
 • This catalog has only typical specifications. Therefore, please approve our product specifications or transact the approval sheet for product specifications before ordering.

Chip Ferrite Bead
 1806 Size

Chip EMIFIL®

Chip Common Mode Choke Coil

Block Type EMIFIL®

Microwave Absorber

BLA2AA/BLA2AB Series (0804 Size)



4-line array, 0804 size.

■ Dimensions

(in mm)

■ Equivalent Circuit

No polarity.

■ Packaging

Code	Packaging	Minimum Quantity
D	180mm Reel Paper Tape	10000
J	330mm Reel Paper Tape	50000
B	Bulk(Bag)	1000

Refer to pages from p.97 to p.100 for mounting information.

■ Rated Value (□: packaging code)

Part Number	Impedance (at 100MHz/20°C)	Rated Current	DC Resistance	Operating Temperature Range
BLA2AAG121SN4□	120ohm ±25%	100mA	0.50ohm max.	-55°C to +125°C
BLA2AAG221SN4□	220ohm ±25%	50mA	0.70ohm max.	-55°C to +125°C
BLA2AAG601SN4□	600ohm ±25%	50mA	1.10ohm max.	-55°C to +125°C
BLA2AAG102SN4□	1000ohm ±25%	50mA	1.30ohm max.	-55°C to +125°C
BLA2ABD750SN4□	75ohm ±25%	200mA	0.20ohm max.	-55°C to +125°C
BLA2ABD121SN4□	120ohm ±25%	200mA	0.35ohm max.	-55°C to +125°C
BLA2ABD221SN4□	220ohm ±25%	100mA	0.40ohm max.	-55°C to +125°C
BLA2ABD471SN4□	470ohm ±25%	100mA	0.65ohm max.	-55°C to +125°C
BLA2ABD601SN4□	600ohm ±25%	100mA	0.80ohm max.	-55°C to +125°C
BLA2ABD102SN4□	1000ohm ±25%	50mA	1.00ohm max.	-55°C to +125°C
BLA2ABB100SN4□	10ohm ±25%	200mA	0.1ohm max.	-55°C to +125°C
BLA2ABB220SN4□	22ohm ±25%	200mA	0.2ohm max.	-55°C to +125°C
BLA2ABB470SN4□	47ohm ±25%	200mA	0.35ohm max.	-55°C to +125°C
BLA2ABB121SN4□	120ohm ±25%	50mA	0.60ohm max.	-55°C to +125°C
BLA2ABB221SN4□	220ohm ±25%	50mA	0.90ohm max.	-55°C to +125°C

Number of Circuits: 4

■ Impedance-Frequency Characteristics

BLA2AAG Series

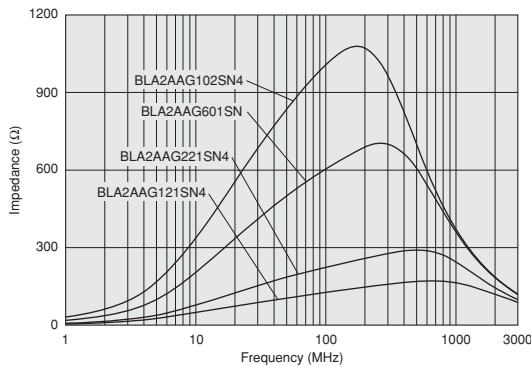

BLA2ABD Series

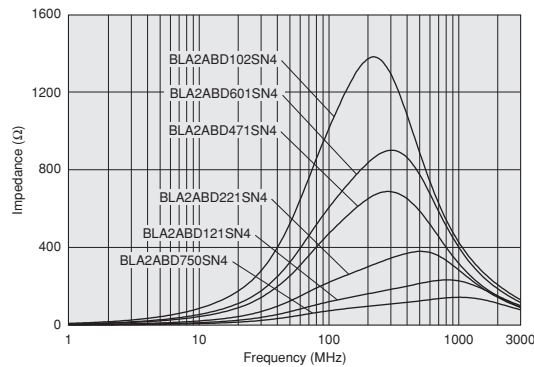

Continued on the following page. ↗

⚠Note • Please read rating and ⚠CAUTION (for storage, operating, rating, soldering, mounting and handling) in this catalog to prevent smoking and/or burning, etc.
 • This catalog has only typical specifications. Therefore, please approve our product specifications or transact the approval sheet for product specifications before ordering.

Impedance-Frequency Characteristics
 BLA2ABB Series

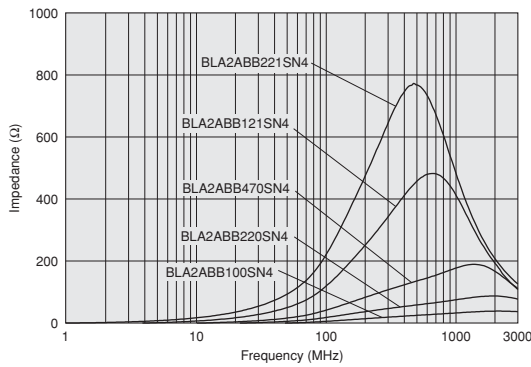

Impedance-Frequency Characteristics

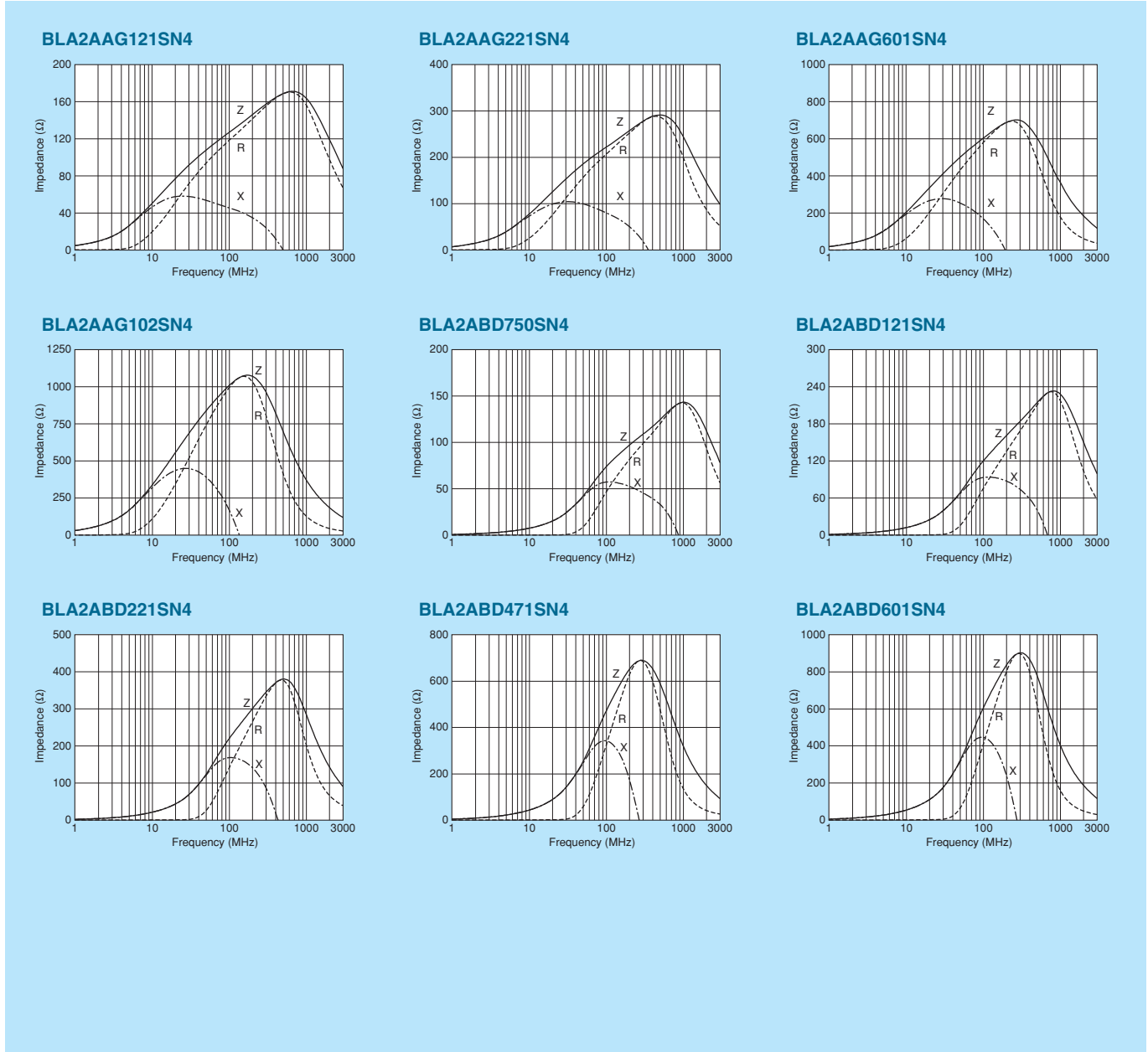

Continued on the following page.

Note • Please read rating and **CAUTION** (for storage, operating, rating, soldering, mounting and handling) in this catalog to prevent smoking and/or burning, etc.
 • This catalog has only typical specifications. Therefore, please approve our product specifications or transact the approval sheet for product specifications before ordering.

Chip Ferrite Bead
0804 Size

Chip EMIFIL®

Chip Common Mode Choke Coil

Block Type EMIFIL®

Microwave Absorber

Impedance-Frequency Characteristics

BLA2ABD102SN4

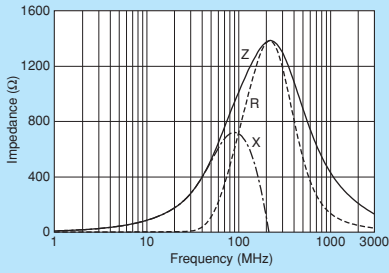

BLA2ABB100SN4

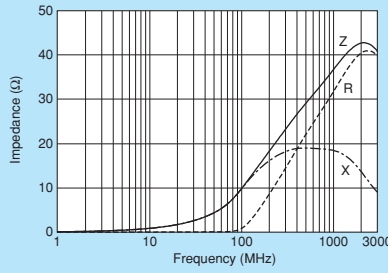

BLA2ABB220SN4

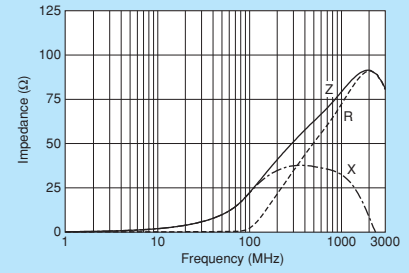

BLA2ABB470SN4

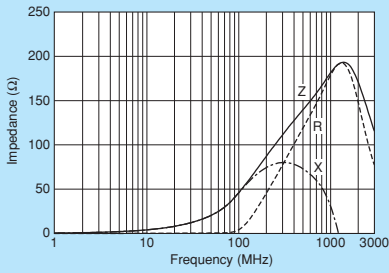

BLA2ABB121SN4

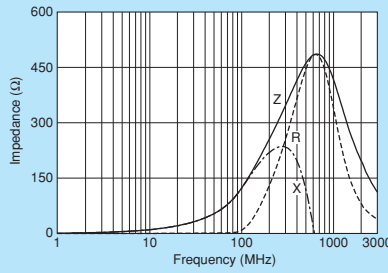

BLA2ABB221SN4

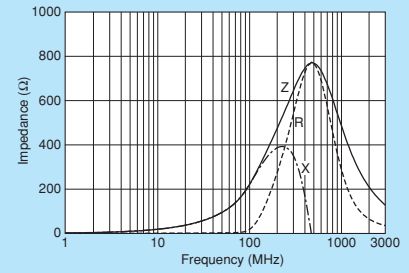

0804 Size
Chip Ferrite Bead

Chip EMIFIL®

Chip Common Mode Choke Coil

Block Type EMIFIL®

Microwave Absorber

⚠Note • Please read rating and ⚠CAUTION (for storage, operating, rating, soldering, mounting and handling) in this catalog to prevent smoking and/or burning, etc.
 • This catalog has only typical specifications. Therefore, please approve our product specifications or transact the approval sheet for product specifications before ordering.

BLA31A/BLA31B Series (1206 Size)



4-line array, 1206 size.

Chip Ferrite Bead
1206 Size

Chip EMIFIL®

Chip Common Mode Choke Coil

Block Type EMIFIL®

Microwave Absorber

■ Dimensions

Legend: Electrode (in mm)

■ Equivalent Circuit

No polarity.

■ Packaging

Code	Packaging	Minimum Quantity
D	180mm Reel Paper Tape	4000
J	330mm Reel Paper Tape	10000
B	Bulk (Bag)	1000

Refer to pages from p.97 to p.100 for mounting information.

■ Rated Value (□: packaging code)

Part Number	Impedance (at 100MHz/20°C)	Rated Current	DC Resistance	Operating Temperature Range
BLA31AG300SN4□	30ohm ±25%	200mA	0.10ohm max.	-55°C to +125°C
BLA31AG600SN4□	60ohm ±25%	200mA	0.15ohm max.	-55°C to +125°C
BLA31AG121SN4□	120ohm ±25%	150mA	0.20ohm max.	-55°C to +125°C
BLA31AG221SN4□	220ohm ±25%	150mA	0.25ohm max.	-55°C to +125°C
BLA31AG601SN4□	600ohm ±25%	100mA	0.35ohm max.	-55°C to +125°C
BLA31AG102SN4□	1000ohm ±25%	50mA	0.45ohm max.	-55°C to +125°C
BLA31BD121SN4□	120ohm ±25%	150mA	0.30ohm max.	-55°C to +125°C
BLA31BD221SN4□	220ohm ±25%	150mA	0.35ohm max.	-55°C to +125°C
BLA31BD471SN4□	470ohm ±25%	100mA	0.40ohm max.	-55°C to +125°C
BLA31BD601SN4□	600ohm ±25%	100mA	0.45ohm max.	-55°C to +125°C
BLA31BD102SN4□	1000ohm ±25%	50mA	0.55ohm max.	-55°C to +125°C

Number of Circuits: 4

■ Impedance-Frequency Characteristics

BLA31AG Series

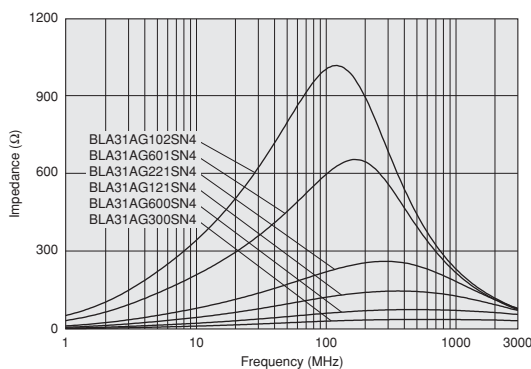

BLA31BD Series

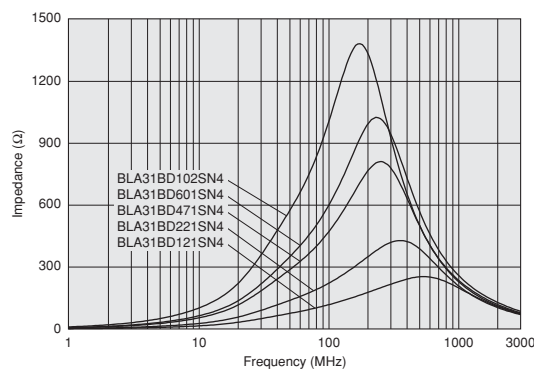

Continued on the following page.

⚠Note • Please read rating and ⚠CAUTION (for storage, operating, rating, soldering, mounting and handling) in this catalog to prevent smoking and/or burning, etc.
• This catalog has only typical specifications. Therefore, please approve our product specifications or transact the approval sheet for product specifications before ordering.

Impedance-Frequency Characteristics

BLA31AG300SN4

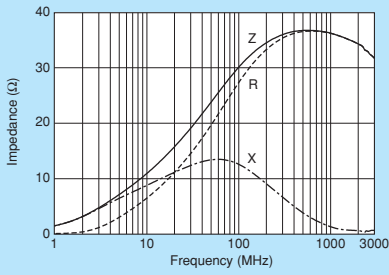

BLA31AG600SN4

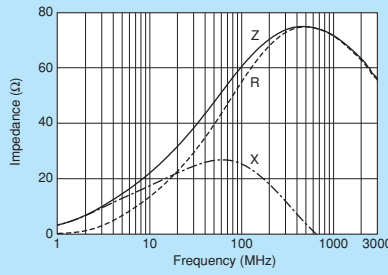

BLA31AG121SN4

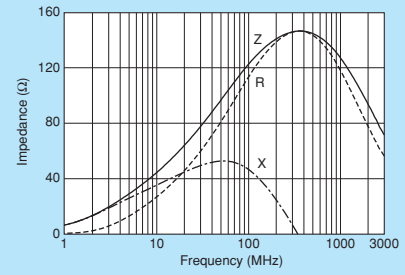

BLA31AG221SN4

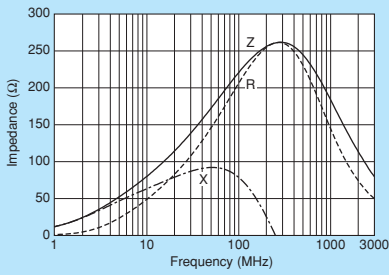

BLA31AG601SN4

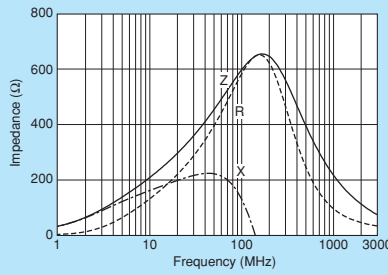

BLA31AG102SN4

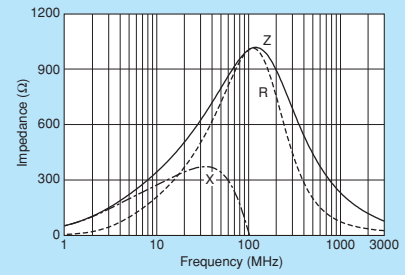

BLA31BD121SN4

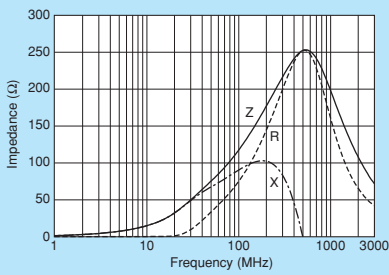

BLA31BD221SN4

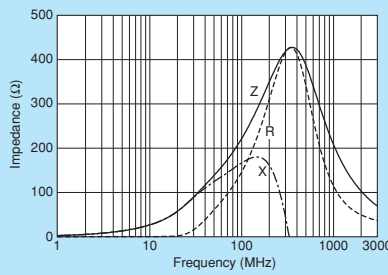

BLA31BD471SN4

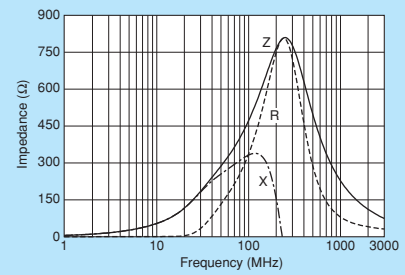

BLA31BD601SN4

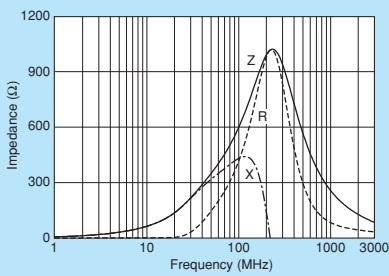

BLA31BD102SN4

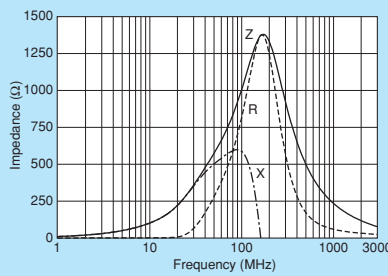

1206 Size
Chip Ferrite Bead

Chip EMIFIL®

Chip Common Mode Choke Coil

Block Type EMIFIL®

Microwave Absorber

⚠Note • Please read rating and ⚠CAUTION (for storage, operating, rating, soldering, mounting and handling) in this catalog to prevent smoking and/or burning, etc.
 • This catalog has only typical specifications. Therefore, please approve our product specifications or transact the approval sheet for product specifications before ordering.

BLM03H Series (0201 Size)



0201 size for GHz band noise.

Chip Ferrite Bead
0201 Size

Chip EMIFIL®

Chip Common Mode Choke Coil

Block Type EMIFIL®

Microwave Absorber

■ Dimensions

■ Equivalent Circuit

(Resistance element becomes dominant at high frequencies.)

■ Packaging

Code	Packaging	Minimum Quantity
D	180mm Reel Paper Tape	15000
J	330mm Reel Paper Tape	50000
B	Bulk(Bag)	1000

Refer to pages from p.97 to p.100 for mounting information.

■ Rated Value (□: packaging code)

Part Number	Impedance (at 100MHz/20°C)	Impedance (at 1GHz/20°C)	Rated Current	DC Resistance	Operating Temperature Range	
BLM03HG601SN1□	600ohm ±25%	1000ohm ±40%	150mA	1.6ohm max.	-55°C to +125°C	Kit
BLM03HG102SN1□	1000ohm ±25%	1800ohm ±40%	125mA	2.6ohm max.	-55°C to +125°C	Kit
BLM03HD331SN1□	330ohm ±25%	750ohm ±40%	200mA	1.0ohm max.	-55°C to +125°C	Kit
BLM03HD471SN1□	470ohm ±25%	1000ohm ±40%	175mA	1.3ohm max.	-55°C to +125°C	Kit
BLM03HD601SN1□	600ohm ±25%	1500ohm ±40%	150mA	1.7ohm max.	-55°C to +125°C	Kit
BLM03HD102SN1□	1000ohm ±25%	2300ohm ±40%	120mA	2.9ohm max.	-55°C to +125°C	Kit
BLM03HB191SN1□	190ohm ±25%	1150ohm ±40%	150mA	2.0ohm max.	-55°C to +125°C	New Kit

Number of Circuits: 1

■ Impedance-Frequency Characteristics

BLM03HG Series

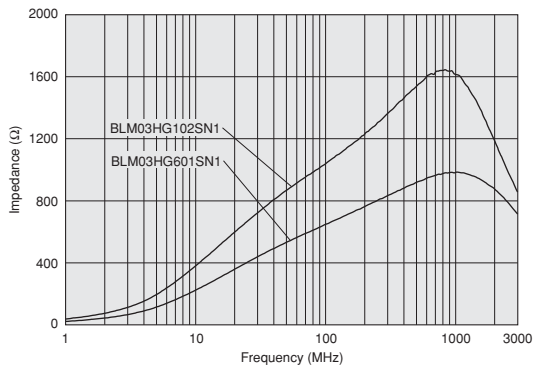

BLM03HD Series

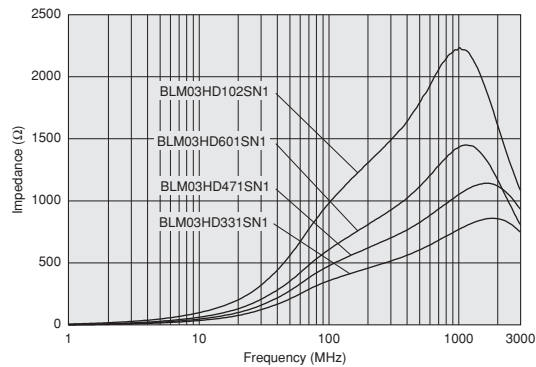

BLM03HB Series

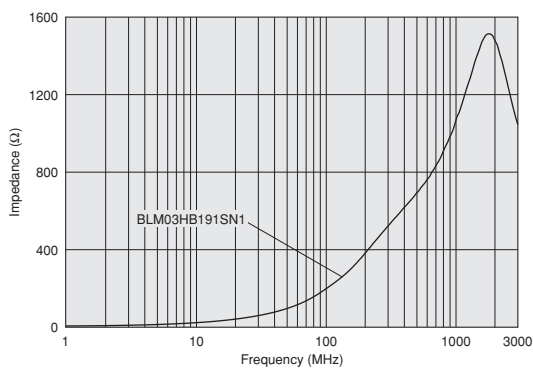

Continued on the following page.

△Note • Please read rating and △CAUTION (for storage, operating, rating, soldering, mounting and handling) in this catalog to prevent smoking and/or burning, etc.
• This catalog has only typical specifications. Therefore, please approve our product specifications or transact the approval sheet for product specifications before ordering.

Impedance-Frequency Characteristics

BLM03HG601SN1

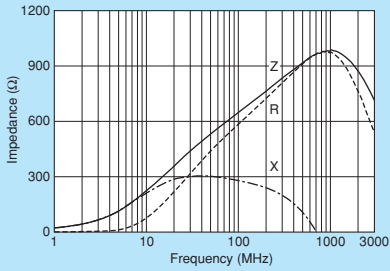

BLM03HG102SN1

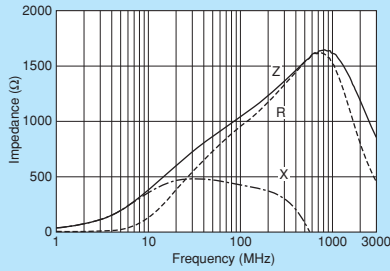

BLM03HD331SN1

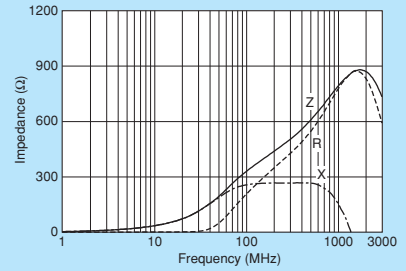

BLM03HD471SN1

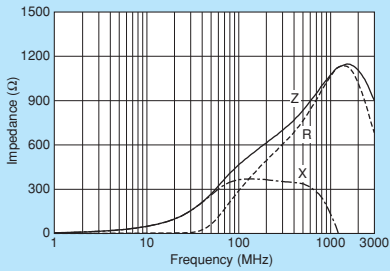

BLM03HD601SN1

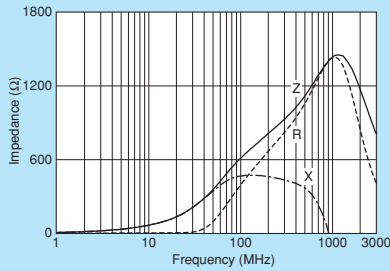

BLM03HD102SN1

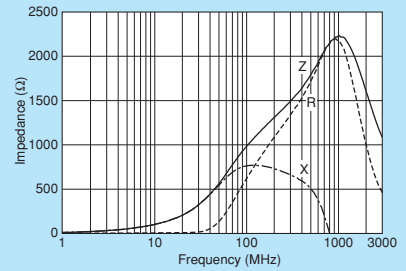

BLM03HB191SN1

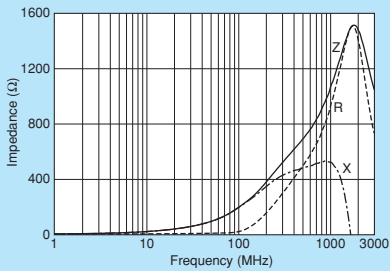

0201 Size
Chip Ferrite Bead

Chip EMIFIL®

Chip Common Mode Choke Coil

Block Type EMIFIL®

Microwave Absorber

⚠Note • Please read rating and ⚠CAUTION (for storage, operating, rating, soldering, mounting and handling) in this catalog to prevent smoking and/or burning, etc.
 • This catalog has only typical specifications. Therefore, please approve our product specifications or transact the approval sheet for product specifications before ordering.

BLM03E Series (0201 Size)



For GHz band noise and capable of large current.

Chip Ferrite Bead
0201 Size

Chip EMIFIL®

Chip Common Mode Choke Coil

Block Type EMIFIL®

Microwave Absorber



■ Dimensions

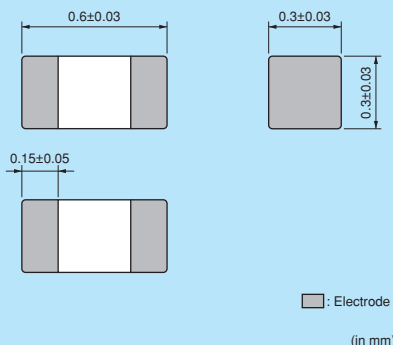

■ Equivalent Circuit

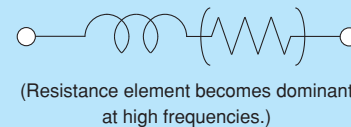

■ Packaging

Code	Packaging	Minimum Quantity
D	180mm Reel Paper Tape	15000
J	330mm Reel Paper Tape	50000
B	Bulk(Bag)	1000

Refer to pages from p.97 to p.100 for mounting information.

■ Rated Value (□: packaging code)

Part Number	Impedance (at 100MHz/20°C)	Impedance (at 1GHz/20°C)	Rated Current	DC Resistance	Operating Temperature Range	New	Kit
BLM03EB250SN1 □	25ohm ±25%	105ohm ±40%	600mA	0.26ohm max.	-55°C to +125°C	<input type="checkbox"/>	<input type="checkbox"/>
BLM03EB500SN1 □	50ohm ±25%	255ohm ±40%	400mA	0.58ohm max.	-55°C to +125°C	<input type="checkbox"/>	<input type="checkbox"/>

Number of Circuits: 1

■ Impedance-Frequency Characteristics

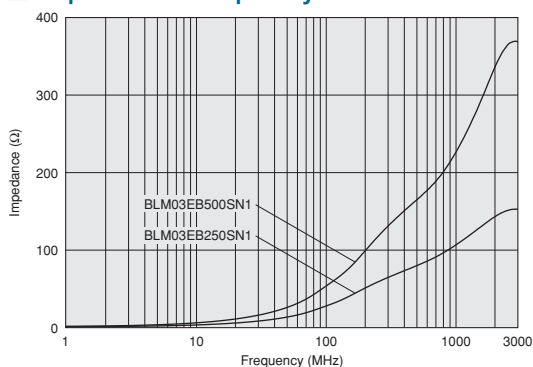

■ Notice (Rating)

In operating temperature exceeding +85°C, derating of current is necessary for BLM03E series. Please apply the derating curve shown in chart according to the operating temperature.

Derating of Rated Current

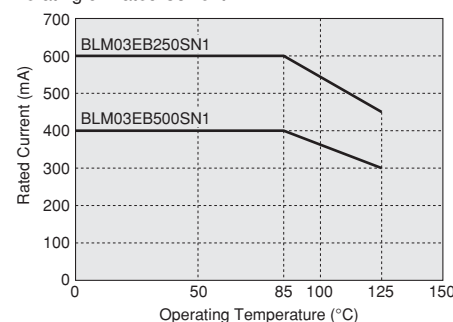

■ Impedance-Frequency Characteristics

BLM03EB250SN1

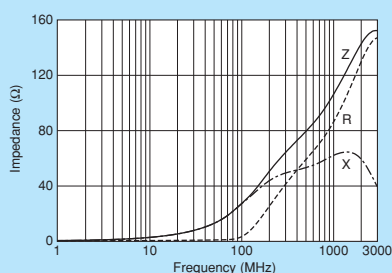

BLM03EB500SN1

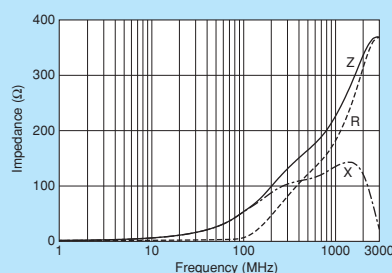

△Note • Please read rating and △CAUTION (for storage, operating, rating, soldering, mounting and handling) in this catalog to prevent smoking and/or burning, etc.
• This catalog has only typical specifications. Therefore, please approve our product specifications or transact the approval sheet for product specifications before ordering.

BLM15H Series (0402 Size)



0402 size for GHz band noise.

■ Dimensions

0.25±0.1
1.0±0.05
0.5±0.05
0.5±0.05

■ Electrode
(in mm)

■ Equivalent Circuit

(Resistance element becomes dominant at high frequencies.)

■ Packaging

Code	Packaging	Minimum Quantity
D	180mm Reel Paper Tape	10000
J	330mm Reel Paper Tape	50000
B	Bulk(Bag)	1000

Refer to pages from p.97 to p.100 for mounting information.

■ Rated Value (□: packaging code)

Part Number	Impedance (at 100MHz/20°C)	Impedance (at 1GHz/20°C)	Rated Current	DC Resistance	Operating Temperature Range	
BLM15HG601SN1□	600ohm ±25%	1000ohm ±40%	300mA	0.7ohm max.	-55°C to +125°C	Kit
BLM15HG102SN1□	1000ohm ±25%	1400ohm ±40%	250mA	1.1ohm max.	-55°C to +125°C	Kit
BLM15HD601SN1□	600ohm ±25%	1400ohm ±40%	300mA	0.85ohm max.	-55°C to +125°C	Kit
BLM15HD102SN1□	1000ohm ±25%	2000ohm ±40%	250mA	1.25ohm max.	-55°C to +125°C	Kit
BLM15HD182SN1□	1800ohm ±25%	2700ohm ±40%	200mA	2.2ohm max.	-55°C to +125°C	Kit
BLM15HB121SN1□	120ohm ±25%	500ohm ±40%	300mA	0.7ohm max.	-55°C to +125°C	Kit
BLM15HB221SN1□	220ohm ±25%	900ohm ±40%	250mA	1.0ohm max.	-55°C to +125°C	Kit

Number of Circuits: 1

■ Impedance-Frequency Characteristics

BLM15HG Series (For General Signal Lines)

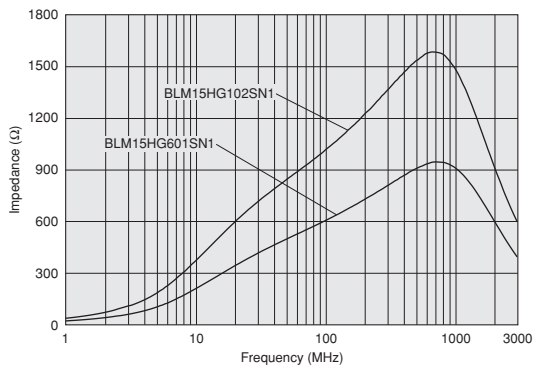

BLM15HD Series (For High Speed Signal Lines)

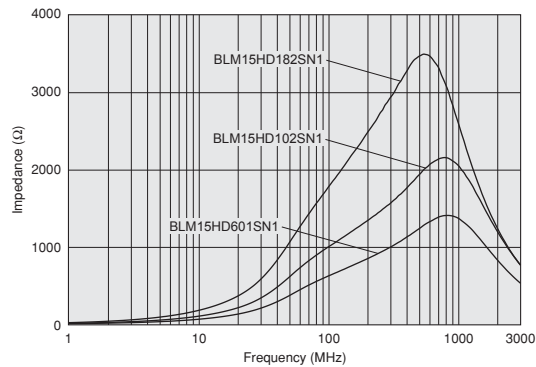

BLM15HB Series (For High Speed Signal Lines)

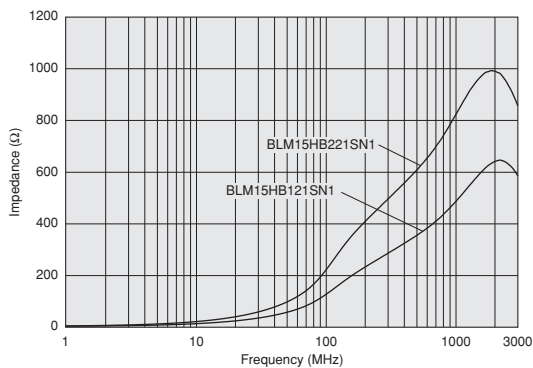

Continued on the following page.

△Note • Please read rating and △CAUTION (for storage, operating, rating, soldering, mounting and handling) in this catalog to prevent smoking and/or burning, etc.
• This catalog has only typical specifications. Therefore, please approve our product specifications or transact the approval sheet for product specifications before ordering.

Impedance-Frequency Characteristics

BLM15HG601SN1

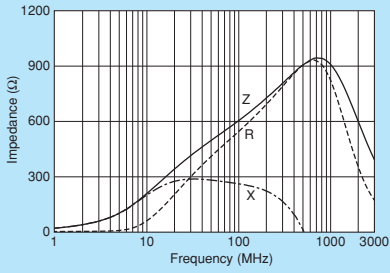

BLM15HG102SN1

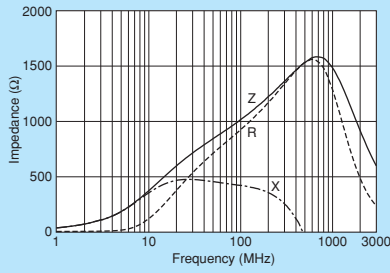

BLM15HD601SN1

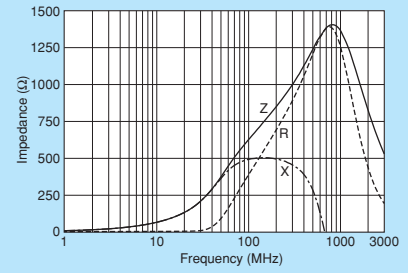

BLM15HD102SN1

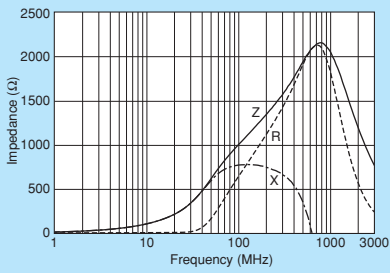

BLM15HD182SN1

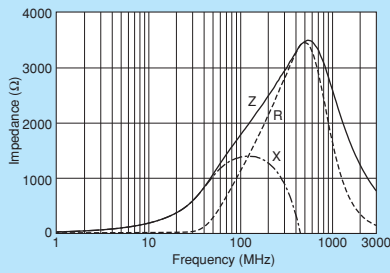

BLM15HB121SN1

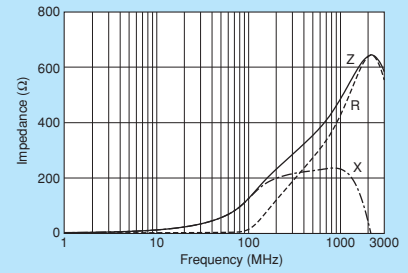

BLM15HB221SN1

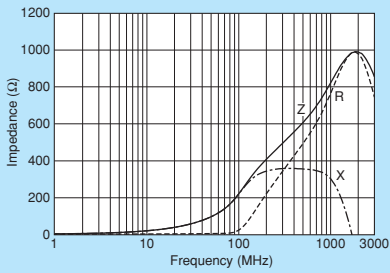

⚠ Note • Please read rating and ⚠ CAUTION (for storage, operating, rating, soldering, mounting and handling) in this catalog to prevent smoking and/or burning, etc.
 • This catalog has only typical specifications. Therefore, please approve our product specifications or transact the approval sheet for product specifications before ordering.

Chip Ferrite Bead
 0402 Size

Chip EMIFIL®

Chip Common Mode Choke Coil

Block Type EMIFIL®

Microwave Absorber

BLM15E Series (0402 Size)



For GHz band noise, also capable to large current.



■ Dimensions

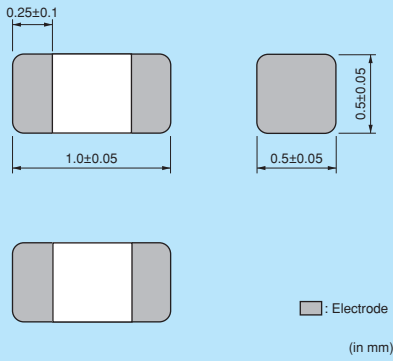

(in mm)

■ Equivalent Circuit



(Resistance element becomes dominant at high frequencies.)

■ Packaging

Code	Packaging	Minimum Quantity
D	180mm Reel Paper Tape	10000
J	330mm Reel Paper Tape	50000
B	Bulk(Bag)	1000

Refer to pages from p.97 to p.100 for mounting information.

■ Rated Value (□: packaging code)

Part Number	Impedance (at 100MHz/20°C)	Impedance (at 1GHz/20°C)	Rated Current	DC Resistance	Operating Temperature Range	
BLM15EG121SN1□	120ohm ±25%	145ohm (Typ.)	1500mA	0.095ohm max.	-55°C to +125°C	Kit ≥1A
BLM15EG221SN1□	220ohm ±25%	270ohm (Typ.)	700mA	0.28ohm max.	-55°C to +125°C	Kit

Number of Circuits: 1

■ Impedance-Frequency Characteristics

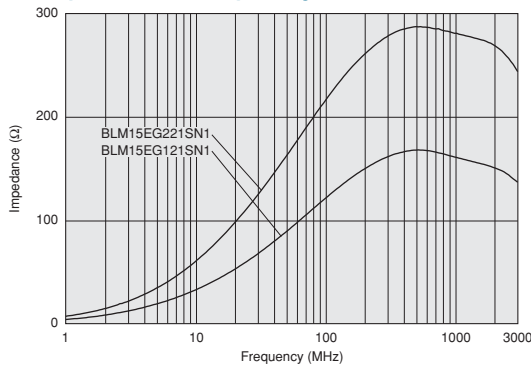

■ Notice (Rating)

In operating temperature exceeding +85°C, derating of current is necessary for BLM15E series. Please apply the derating curve shown in chart according to the operating temperature.

Derating of Rated Current

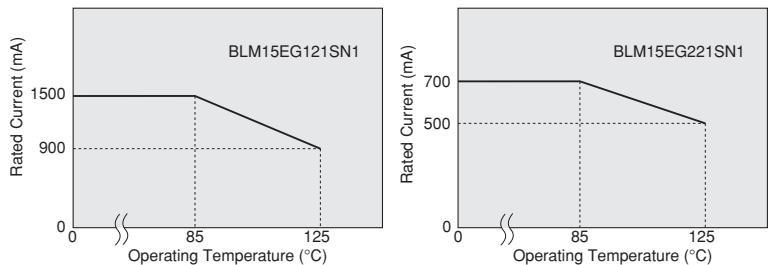

■ Impedance-Frequency Characteristics

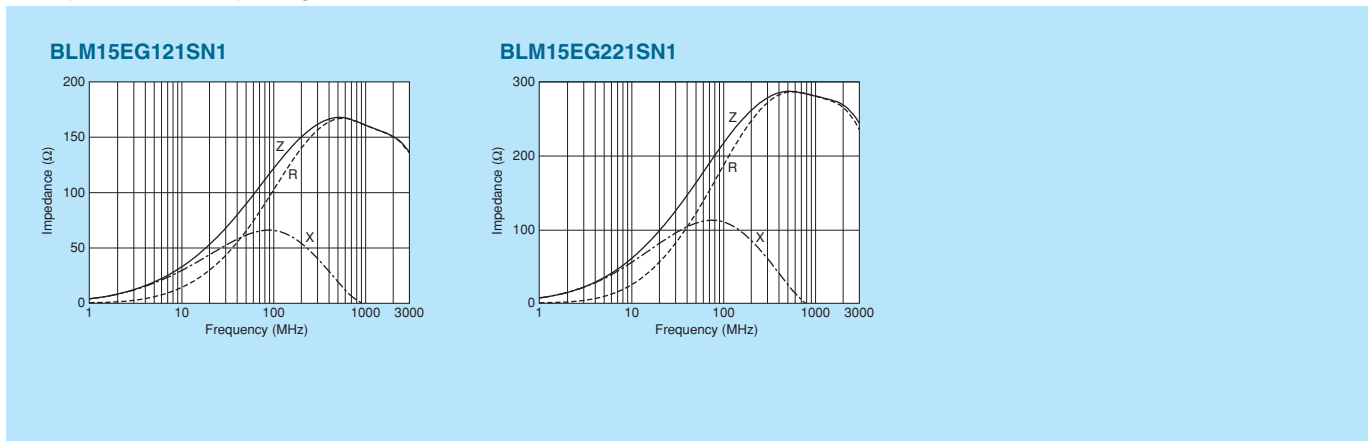

⚠Note • Please read rating and ⚠CAUTION (for storage, operating, rating, soldering, mounting and handling) in this catalog to prevent smoking and/or burning, etc.
 • This catalog has only typical specifications. Therefore, please approve our product specifications or transact the approval sheet for product specifications before ordering.

BLM15G Series (0402 Size)



Available up to high-GHz band noise.

Chip Ferrite Bead
0402 Size

Chip EMIFIL®

Chip Common Mode Choke Coil

Block Type EMIFIL®

Microwave Absorber



■ Dimensions

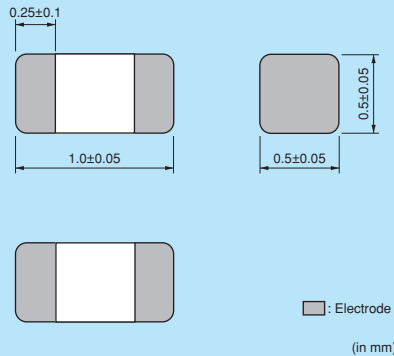

■ Equivalent Circuit

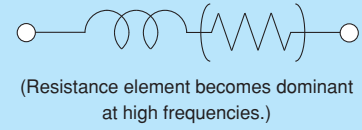

■ Packaging

Code	Packaging	Minimum Quantity
D	180mm Reel Paper Tape	10000
J	330mm Reel Paper Tape	50000
B	Bulk(Bag)	1000

Refer to pages from p.97 to p.100 for mounting information.

■ Rated Value (□: packaging code)

Part Number	Impedance (at 100MHz/20°C)	Impedance (at 1GHz/20°C)	Rated Current	DC Resistance	Operating Temperature Range	
BLM15GG221SN1□	220ohm ±25%	600ohm ±40%	300mA	0.7ohm max.	-55°C to +125°C	Kit
BLM15GG471SN1□	470ohm ±25%	1200ohm ±40%	200mA	1.3ohm max.	-55°C to +125°C	Kit
BLM15GA750SN1□	75ohm ±25%	1000ohm ±40%	200mA	1.3ohm max.	-55°C to +125°C	Kit

Number of Circuits: 1

■ Impedance-Frequency Characteristics

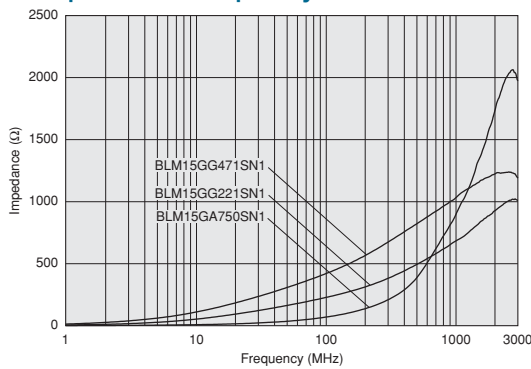

■ Impedance-Frequency Characteristics

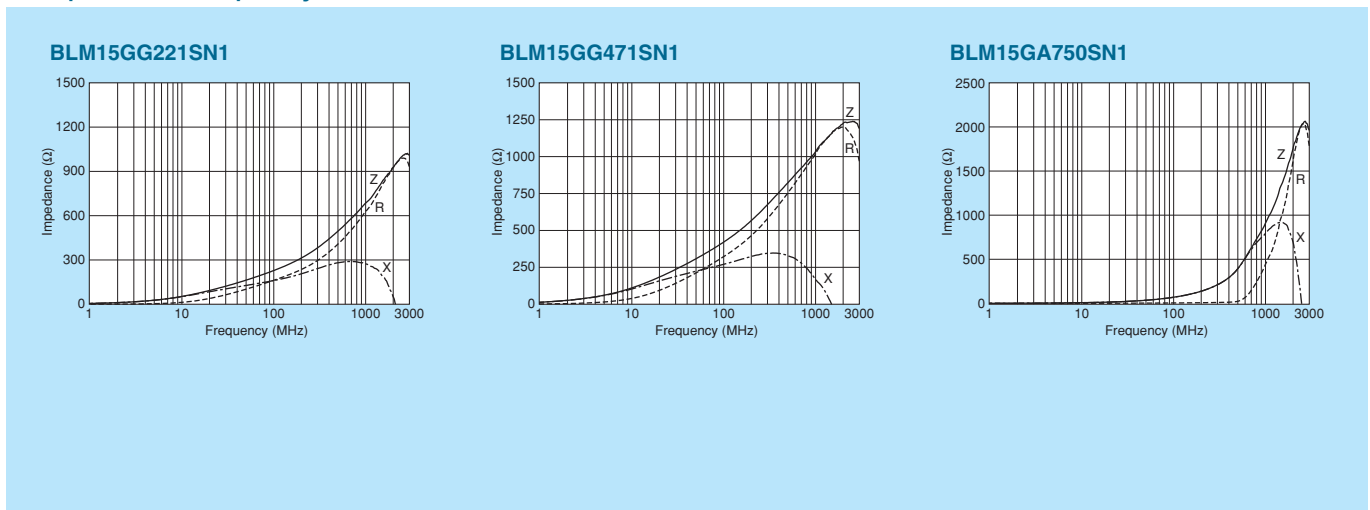

⚠Note • Please read rating and ⚠CAUTION (for storage, operating, rating, soldering, mounting and handling) in this catalog to prevent smoking and/or burning, etc.
• This catalog has only typical specifications. Therefore, please approve our product specifications or transact the approval sheet for product specifications before ordering.

BLM18H Series (0603 Size)



0603 size for GHz band noise. BLM18HE also supports power lines.

*Please refer to BLM15H for downsizing.



■ Dimensions

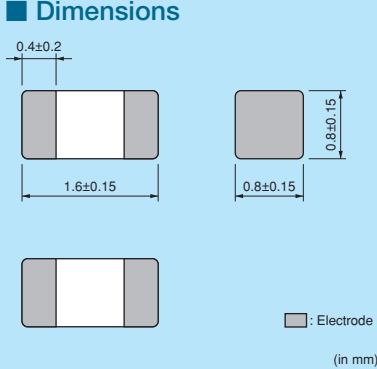

(in mm)

■ Equivalent Circuit



(Resistance element becomes dominant at high frequencies.)

■ Packaging

Code	Packaging	Minimum Quantity
D	180mm Reel Paper Tape	4000
J	330mm Reel Paper Tape	10000
B	Bulk(Bag)	1000

Refer to pages from p.97 to p.100 for mounting information.

■ Rated Value (□: packaging code)

Part Number	Impedance (at 100MHz/20°C)	Impedance (at 1GHz/20°C)	Rated Current	DC Resistance	Operating Temperature Range	
BLM18HG471SN1□	470ohm ±25%	600ohm (Typ.)	200mA	0.85ohm max.	-55°C to +125°C	Kit
BLM18HG601SN1□	600ohm ±25%	700ohm (Typ.)	200mA	1.00ohm max.	-55°C to +125°C	Kit
BLM18HG102SN1□	1000ohm ±25%	1000ohm (Typ.)	100mA	1.60ohm max.	-55°C to +125°C	Kit
BLM18HE601SN1□	600ohm ±25%	600ohm (Typ.)	800mA	0.25ohm max.	-55°C to +125°C	Kit
BLM18HE102SN1□	1000ohm ±25%	1000ohm (Typ.)	600mA	0.35ohm max.	-55°C to +125°C	Kit
BLM18HE152SN1□	1500ohm ±25%	1500ohm (Typ.)	500mA	0.50ohm max.	-55°C to +125°C	Kit
BLM18HD471SN1□	470ohm ±25%	1000ohm (Typ.)	100mA	1.20ohm max.	-55°C to +125°C	Kit
BLM18HD601SN1□	600ohm ±25%	1200ohm (Typ.)	100mA	1.50ohm max.	-55°C to +125°C	Kit
BLM18HD102SN1□	1000ohm ±25%	1700ohm (Typ.)	50mA	1.80ohm max.	-55°C to +125°C	Kit
BLM18HB121SN1□	120ohm ±25%	500ohm ±40%	200mA	0.50ohm max.	-55°C to +125°C	Kit
BLM18HB221SN1□	220ohm ±25%	1100ohm ±40%	100mA	0.80ohm max.	-55°C to +125°C	Kit
BLM18HB331SN1□	330ohm ±25%	1600ohm ±40%	50mA	1.20ohm max.	-55°C to +125°C	Kit
BLM18HK331SN1□	330ohm ±25%	400ohm ±40%	200mA	0.50ohm max.	-55°C to +125°C	Kit
BLM18HK471SN1□	470ohm ±25%	600ohm ±40%	200mA	0.70ohm max.	-55°C to +125°C	Kit
BLM18HK601SN1□	600ohm ±25%	700ohm ±40%	100mA	0.90ohm max.	-55°C to +125°C	Kit
BLM18HK102SN1□	1000ohm ±25%	1200ohm ±40%	50mA	1.50ohm max.	-55°C to +125°C	Kit

Number of Circuits: 1

■ Impedance-Frequency Characteristics

BLM18HG Series (For General Signal Lines)

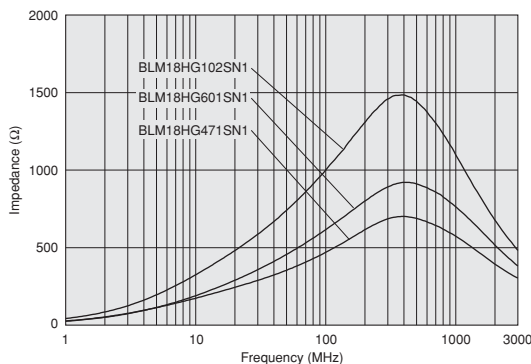

BLM18HE Series (For High Speed Signal Lines)

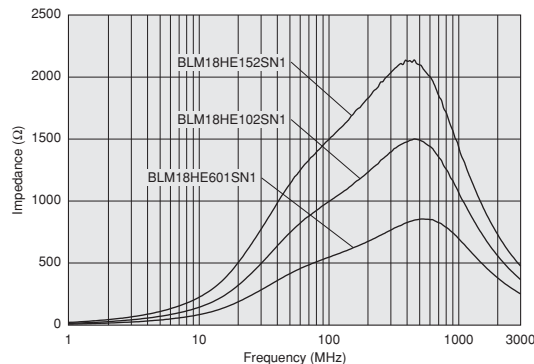

Continued on the following page. ↗

△Note • Please read rating and △CAUTION (for storage, operating, rating, soldering, mounting and handling) in this catalog to prevent smoking and/or burning, etc.
 • This catalog has only typical specifications. Therefore, please approve our product specifications or transact the approval sheet for product specifications before ordering.

Impedance-Frequency Characteristics
BLM18HD Series (For High Speed Signal Lines)

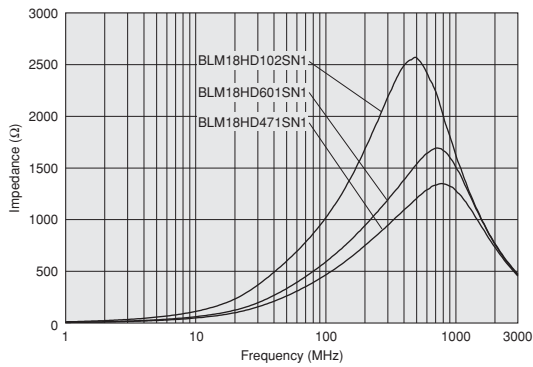

BLM18HB Series (For High Speed Signal Lines)

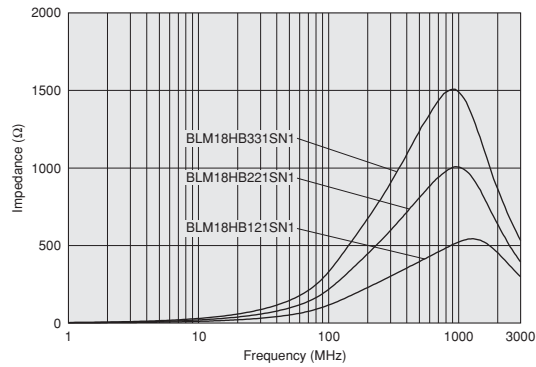

BLM18HK Series (For Digital Interface Lines)

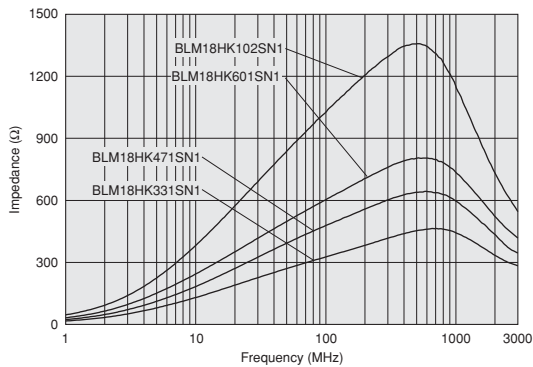

Notice (Rating)

In operating temperature exceeding +85°C, derating of current is necessary for BLM18HE series.

Please apply the derating curve shown in chart according to the operating temperature.

Derating of Rated Current

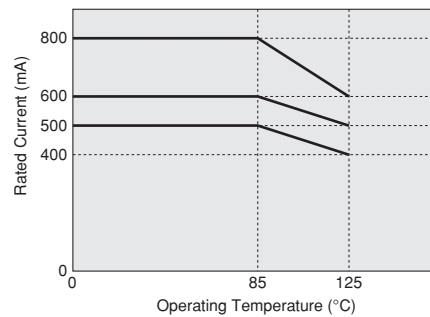

Impedance-Frequency Characteristics

BLM18HG471SN1

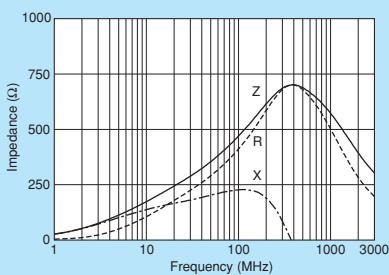

BLM18HG601SN1

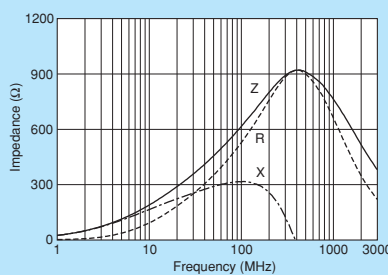

BLM18HG102SN1

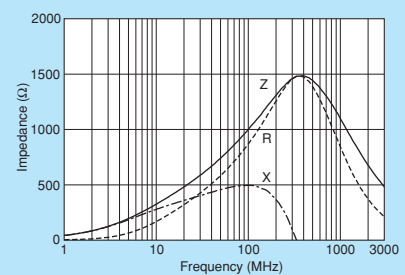

BLM18HE601SN1

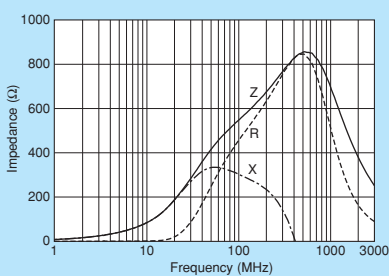

BLM18HE102SN1

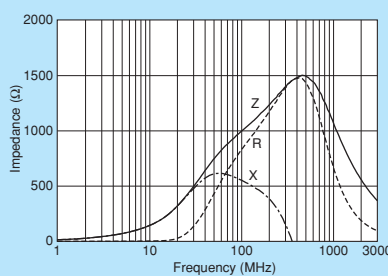

BLM18HE152SN1

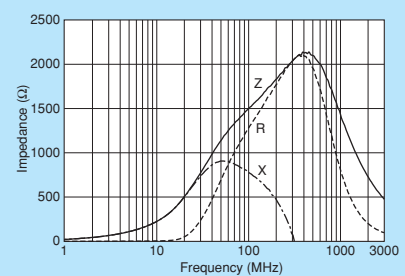

Continued on the following page.

Note • Please read rating and **CAUTION** (for storage, operating, rating, soldering, mounting and handling) in this catalog to prevent smoking and/or burning, etc.
 • This catalog has only typical specifications. Therefore, please approve our product specifications or transact the approval sheet for product specifications before ordering.

Chip Ferrite Bead
 0603 Size

Chip EMIFIL®

Chip Common Mode Choke Coil

Block Type EMIFIL®

Microwave Absorber

Impedance-Frequency Characteristics

BLM18HD471SN1

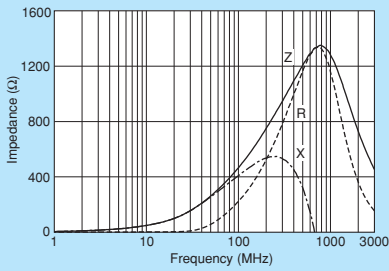

BLM18HD601SN1

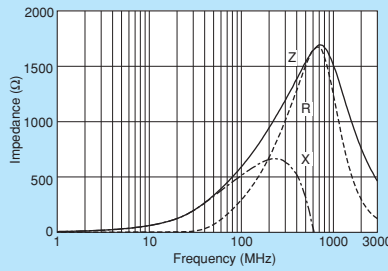

BLM18HD102SN1

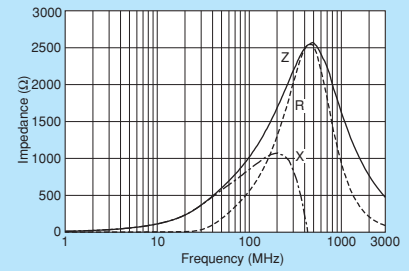

BLM18HB121SN1

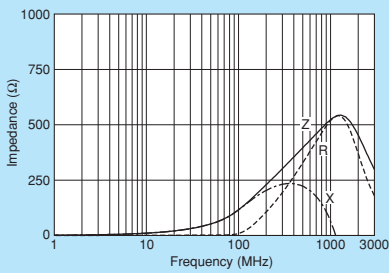

BLM18HB221SN1

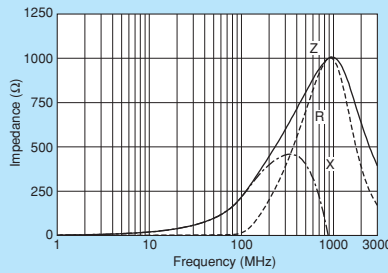

BLM18HB331SN1

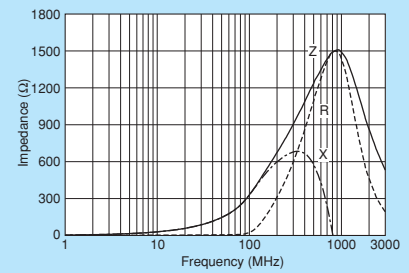

BLM18HK331SN1

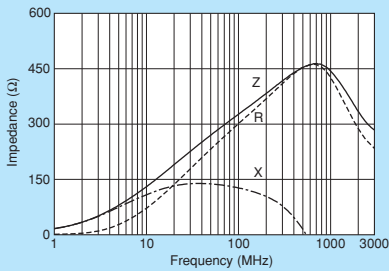

BLM18HK471SN1

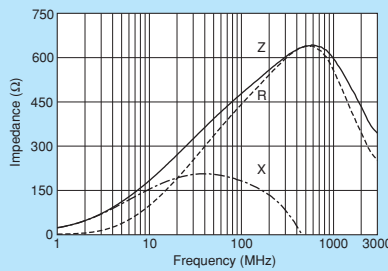

BLM18HK601SN1

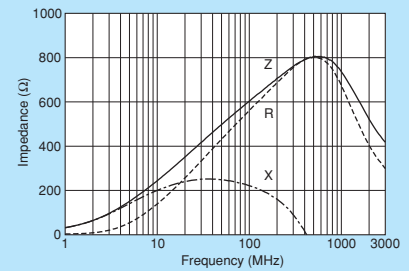

BLM18HK102SN1

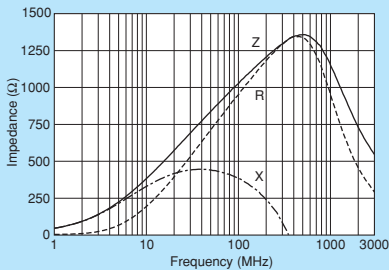

0603 Size
Chip Ferrite Bead

Chip EMIFIL®

Chip Common Mode Choke Coil

Block Type EMIFIL®

Microwave Absorber

⚠Note • Please read rating and ⚠CAUTION (for storage, operating, rating, soldering, mounting and handling) in this catalog to prevent smoking and/or burning, etc.
 • This catalog has only typical specifications. Therefore, please approve our product specifications or transact the approval sheet for product specifications before ordering.

Noise Suppression of BLM18H in UHF Range

Testing Circuit

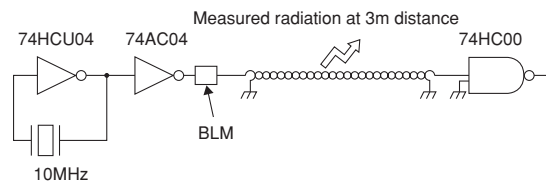

Type of Filter EMI Suppression Effect / Description

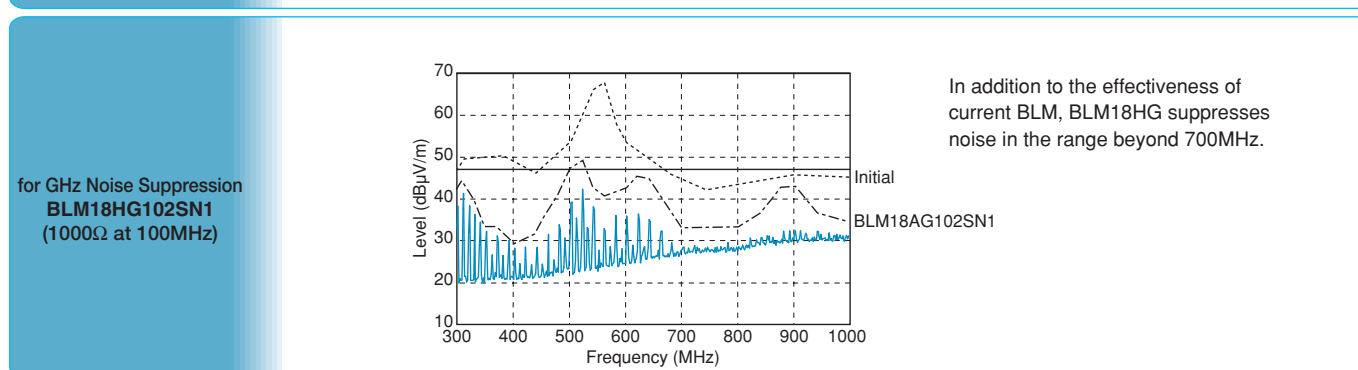
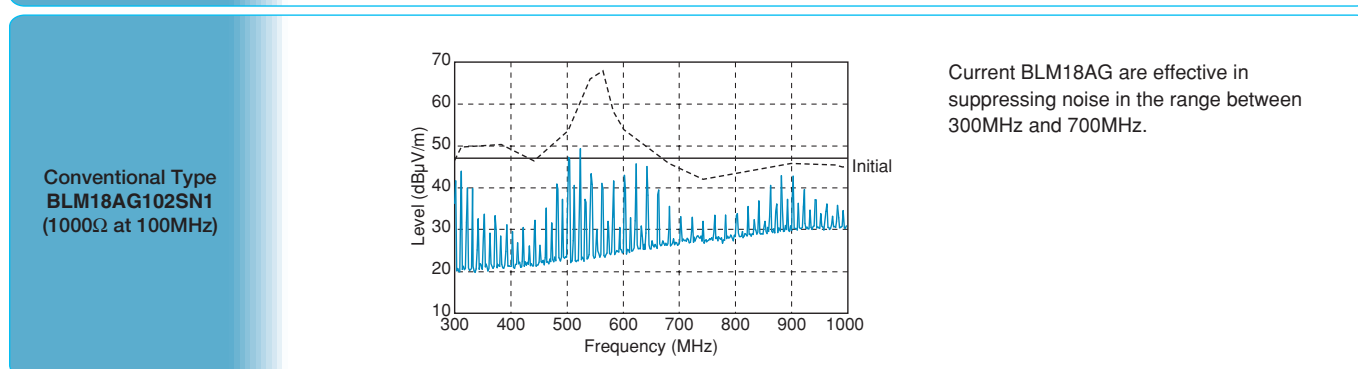
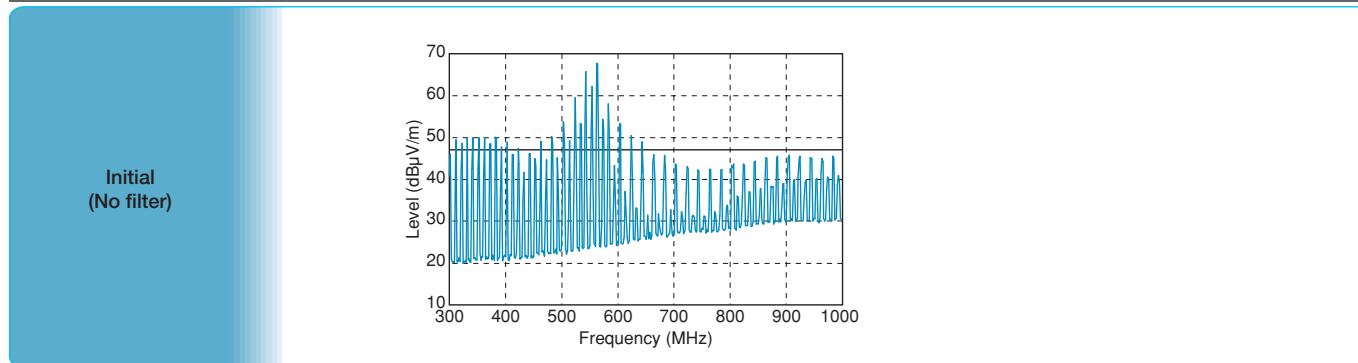

Comparison between BLM18HG102SN1 and BLM18AG102SN1 (Current Item)

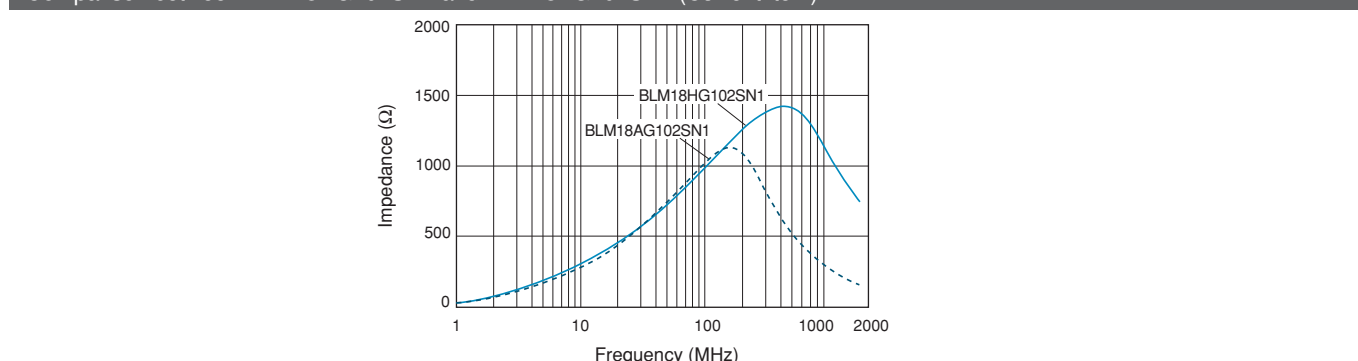

△Note • Please read rating and △CAUTION (for storage, operating, rating, soldering, mounting and handling) in this catalog to prevent smoking and/or burning, etc.
• This catalog has only typical specifications. Therefore, please approve our product specifications or transact the approval sheet for product specifications before ordering.

Chip Ferrite Bead

Chip EMIFIL®

Chip Common Mode Choke Coil

Block Type EMIFIL®

Microwave Absorber

BLM18E Series (0603 Size)



For GHz band noise, also capable to large current.



■ Dimensions

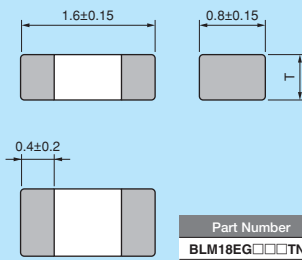

Part Number	T
BLM18EG□□□TN1	0.5±0.15
BLM18EG□□□SN1	0.8±0.15

□: Electrode
(in mm)

■ Equivalent Circuit



(Resistance element becomes dominant at high frequencies.)

■ Packaging

Code	Packaging	Minimum Quantity
D	180mm Reel Paper Tape	4000
J	330mm Reel Paper Tape	10000
B	Bulk(Bag)	1000

Refer to pages from p.97 to p.100 for mounting information.

■ Rated Value (□: packaging code)

Part Number	Impedance (at 100MHz/20°C)	Impedance (at 1GHz/20°C)	Rated Current	DC Resistance	Operating Temperature Range	Kit
BLM18EG101TN1□	100ohm ±25%	140ohm (Typ.)	2000mA	0.045ohm max.	-55°C to +125°C	Kit ≥1A
BLM18EG121SN1□	120ohm ±25%	145ohm (Typ.)	2000mA	0.04ohm max.	-55°C to +125°C	Kit ≥1A
BLM18EG221SN1□	220ohm ±25%	260ohm (Typ.)	2000mA	0.05ohm max.	-55°C to +125°C	Kit ≥1A
BLM18EG221TN1□	220ohm ±25%	300ohm (Typ.)	1000mA	0.15ohm max.	-55°C to +125°C	Kit ≥1A
BLM18EG331TN1□	330ohm ±25%	450ohm (Typ.)	500mA	0.21ohm max.	-55°C to +125°C	Kit
BLM18EG391TN1□	390ohm ±25%	520ohm (Typ.)	500mA	0.3ohm max.	-55°C to +125°C	Kit
BLM18EG471SN1□	470ohm ±25%	550ohm (Typ.)	500mA	0.21ohm max.	-55°C to +125°C	Kit
BLM18EG601SN1□	600ohm ±25%	700ohm (Typ.)	500mA	0.35ohm max.	-55°C to +125°C	Kit

Number of Circuits: 1

■ Impedance-Frequency Characteristics

BLM18EG_TN1 Series

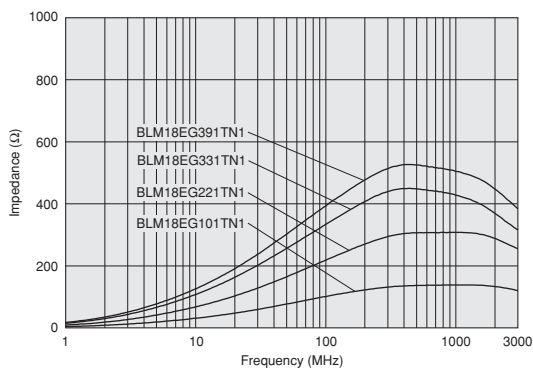

BLM18EG_SN1 Series

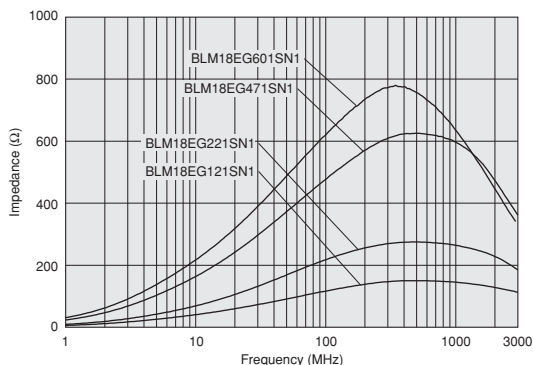

■ Notice (Rating)

In operating temperature exceeding +85°C, derating of current is necessary for BLM18EG series. Please apply the derating curve shown in chart according to the operating temperature.

Derating of Rated Current

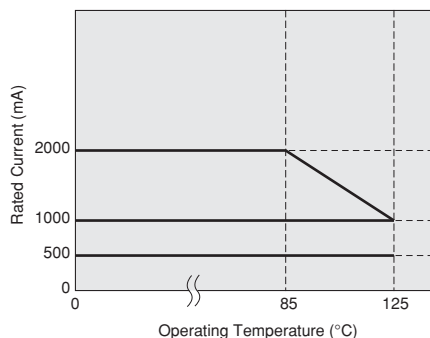

Continued on the following page.

⚠Note • Please read rating and ⚠CAUTION (for storage, operating, rating, soldering, mounting and handling) in this catalog to prevent smoking and/or burning, etc.
• This catalog has only typical specifications. Therefore, please approve our product specifications or transact the approval sheet for product specifications before ordering.

Impedance-Frequency Characteristics

BLM18EG101TN1

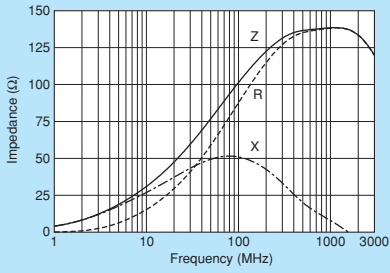

BLM18EG121SN1

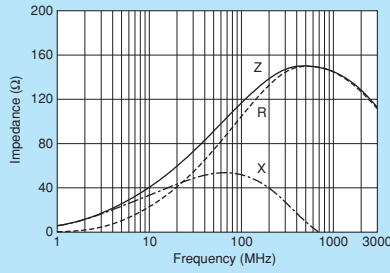

BLM18EG221SN1

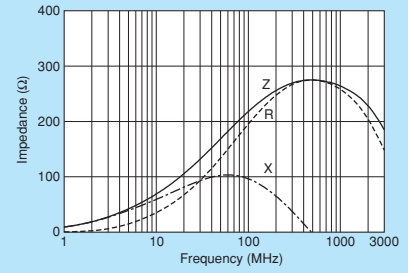

BLM18EG221TN1

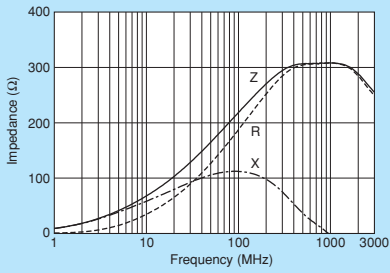

BLM18EG331TN1

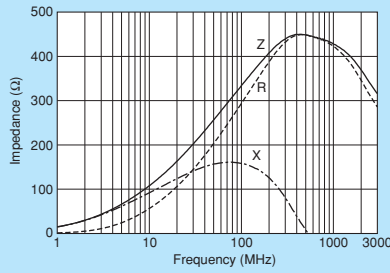

BLM18EG391TN1

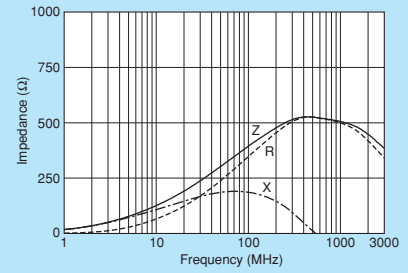

BLM18EG471SN1

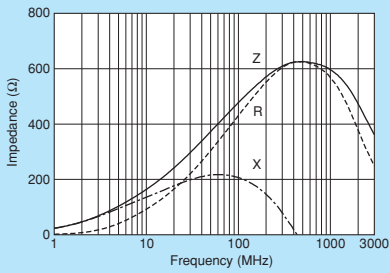

BLM18EG601SN1

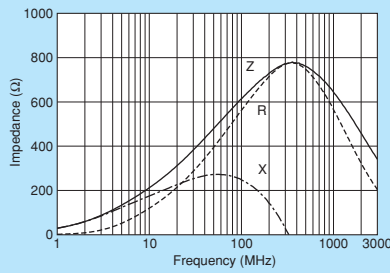

⚠ Note • Please read rating and ⚠ CAUTION (for storage, operating, rating, soldering, mounting and handling) in this catalog to prevent smoking and/or burning, etc.
 • This catalog has only typical specifications. Therefore, please approve our product specifications or transact the approval sheet for product specifications before ordering.

Chip Ferrite Bead
 0603 Size

Chip EMIFIL®

Chip Common Mode Choke Coil

Block Type EMIFIL®

Microwave Absorber

BLM18G Series (0603 Size)



Available up to high-GHz band noise.



■ Dimensions

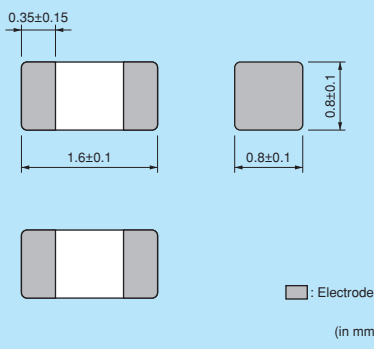

(in mm)

■ Equivalent Circuit



(Resistance element becomes dominant at high frequencies.)

■ Packaging

Code	Packaging	Minimum Quantity
D	180mm Reel Paper Tape	4000
J	330mm Reel Paper Tape	10000
B	Bulk(Bag)	1000

Refer to pages from p.97 to p.100 for mounting information.

■ Rated Value (□: packaging code)

Part Number	Impedance (at 100MHz/20°C)	Impedance (at 1GHz/20°C)	Rated Current	DC Resistance	Operating Temperature Range	
BLM18GG471SN1 □	470ohm ±25%	1800ohm ±30%	200mA	1.0ohm ±0.3ohm	-55°C to +125°C	Kit

Number of Circuits: 1

■ Impedance-Frequency Characteristics

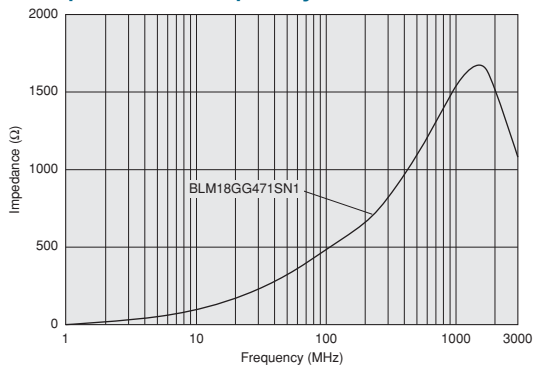

■ Impedance-Frequency Characteristics



⚠Note • Please read rating and ⚠CAUTION (for storage, operating, rating, soldering, mounting and handling) in this catalog to prevent smoking and/or burning, etc.
 • This catalog has only typical specifications. Therefore, please approve our product specifications or transact the approval sheet for product specifications before ordering.

⚠ Caution

● Rating

1. About the Rated Current
Do not use products beyond the rated current as this may create excessive heat and deteriorate the insulation resistance.
2. About the Excessive Surge Current
Excessive surge current (pulse current or rush current) than specified rated current applied to the product may cause a critical failure, such as an open circuit, burnout caused by excessive temperature rise. Please contact us in advance in case of applying the surge current.

● Soldering and Mounting

- Self-heating
Please provide special attention when mounting chip ferrite beads BLM_AX/P/K/S series in close proximity to other products that radiate heat.
The heat generated by other products may deteriorate the insulation resistance and cause excessive heat in this component.

Notice

● Storage and Operating Conditions

<Operating Environment>

Do not use products in a chemical atmosphere such as chlorine gas, acid or sulfide gas.

Do not use products in the environment close to the organic solvent.

<Storage and Handling Requirements>

1. Storage Period
BLM15E/15H/15G series should be used within 12 months, the other series should be used within 6 months.
Solderability should be checked if this period is exceeded.
2. Storage Conditions
 - (1) Storage temperature: -10 to +40°C
Relative humidity: 15 to 85%
Avoid sudden changes in temperature and humidity.
 - (2) Do not store products in a chemical atmosphere such as chlorine gas, acid or sulfide gas.

● Handling

1. Resin Coating
Using resin for coating/molding products may affect the products performance.
So please pay careful attention in selecting resin.
Prior to use, please make the reliability evaluation with the product mounted in your application set.
2. Handling of a Substrate
After mounting products on a substrate, do not apply any stress to the product caused by bending or twisting to the substrate when cropping the substrate, inserting and removing a connector from the substrate or tightening screw to the substrate.
Excessive mechanical stress may cause cracking in the Product.

Bending

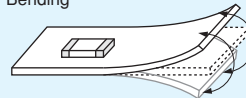

Twisting

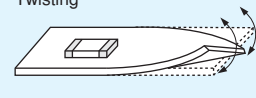

● Notice (Soldering and Mounting)

1. Cleaning
Failure and degradation of a product are caused by the cleaning method. When you clean in conditions that are not in mounting information, please contact Murata engineering.
2. Soldering
Reliability decreases with improper soldering methods. Please solder by the standard soldering conditions shown in mounting information.
3. Other
Noise suppression levels resulting from Murata's EMI suppression filters EMIFIL® may vary, depending on the circuits and ICs used, type of noise, mounting pattern, mounting location, and other operating conditions. Be sure to check and confirm in advance the noise suppression effect of each filter, in actual circuits, etc. before applying the filter in a commercial-purpose equipment design.

⚠ Note • Please read rating and ⚠ CAUTION (for storage, operating, rating, soldering, mounting and handling) in this catalog to prevent smoking and/or burning, etc.
• This catalog has only typical specifications. Therefore, please approve our product specifications or transact the approval sheet for product specifications before ordering.

1. Standard Land Pattern Dimensions

Land Pattern + Solder Resist
 Land Pattern
 Solder Resist

(in mm)

BLM02
BLM03
BLM15
BLM18
BLM21
BLM31
BLM41

●Reflow and Flow
BLM Series

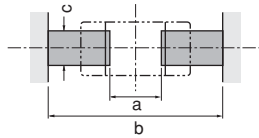

BLM□□AX/P/K/S/E

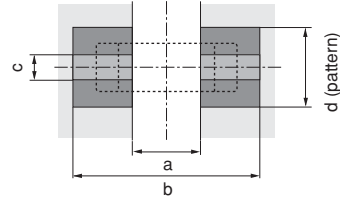

Type	Soldering	a	b	c
BLM02	Reflow	0.16-0.2	0.4-0.56	0.2-0.23
BLM03	Reflow	0.2-0.3	0.6-0.9	0.3
BLM15	Reflow	0.4	1.2-1.4	0.5
BLM18	Flow (except 18G)	0.7	2.2-2.6	0.7
	Reflow		1.8-2.0	
BLM21	Flow/ Reflow	1.2	3.0-4.0	1.0

• Except for BLM03PG·PX·EB/15AX·PD·PG·PX/
18PG·KG·SG/21PG. And BLM02/03/15/18G
is specially adapted for reflow soldering.

Type	Rated Current (A)	Soldering	a	b	c	Land Pad Thickness and Dimension d		
						18μm	35μm	70μm
BLM03AX BLM03P □ BLM03EB	0.9max.	Reflow	0.2-0.3	0.6-0.9	0.3	0.3	0.3	0.3
	1.8max.					1.2	0.7	0.3
BLM15AX BLM15PD BLM15PG BLM15PX	1.5max.	Reflow	0.4	1.2-1.4	0.5	0.5	0.5	0.5
	2.2max.					1.2	0.7	0.5
	3.0max.					2.4	1.2	0.5
BLM18PG BLM18KG BLM18SG	0.5-1.5	Flow/ Reflow	0.7	Flow 2.2-2.6 Reflow 1.8-2.0	0.7	0.7	0.7	0.7
	1.7-2.5					1.2	0.7	0.7
	3-4					2.4	1.2	0.7
BLM21PG	5-6	Flow/ Reflow	1.2	3.0-4.0	1.0	6.4	3.3	1.65
	1.5					1.0	1.0	1.0
	2					1.2	1.0	1.0
	3-4					2.4	1.2	1.0
BLM31PG	6	Flow/ Reflow	2.0	4.2-5.2	1.2	6.4	3.3	1.65
	1.5-2					1.2	1.2	1.2
	3.5					2.4	1.2	1.2
BLM41PG	6	Flow/ Reflow	3.0	5.5-6.5	1.2	2.4	1.2	1.2
	3.5					6.4	3.3	1.65

• Do not apply narrower pattern than listed above to
BLM□□AX/P/K/S.
Narrow pattern can cause excessive heat or open circuit.

BLA2A
BLA31

●Reflow Soldering

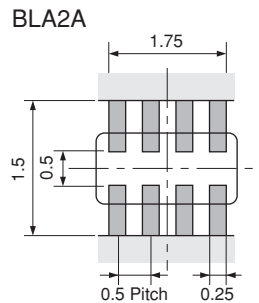

●Reflow and Flow

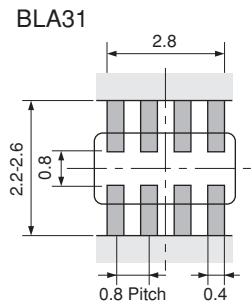

• If there are high amounts of self-heating on pattern, the
contact points of PCB and part may become damaged.

△Note • Please read rating and △CAUTION (for storage, operating, rating, soldering, mounting and handling) in this catalog to prevent smoking and/or burning, etc.
• This catalog has only typical specifications. Therefore, please approve our product specifications or transact the approval sheet for product specifications before ordering.

● PCB Warping

PCB should be designed so that products are not subjected to the mechanical stress caused by warping the board.

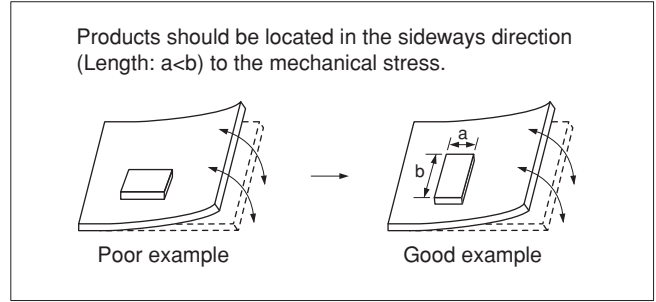

2. Solder Paste Printing and Adhesive Application

When reflow soldering the chip ferrite beads, the printing must be conducted in accordance with the following cream solder printing conditions.

If too much solder is applied, the chip will be prone to damage by mechanical and thermal stress from the PCB and may crack.

Standard land dimensions should be used for resist and copper foil patterns.

When flow soldering the chip ferrite beads, apply the adhesive in accordance with the following conditions. If too much adhesive is applied, then it may overflow into the land or termination areas and yield poor solderability. In contrast, if insufficient adhesive is applied, or if the adhesive is not sufficiently hardened, then the chip may become detached during flow soldering process.

(in mm)

Series	Solder Paste Printing	Adhesive Application
BLM	<ul style="list-style-type: none"> ● Ensure that solder is applied smoothly to a minimum height of 0.2mm to 0.3mm at the end surface of the part. ● Guideline of solder paste thickness: 50-80µm: BLM02 100-150µm: BLM03 100-200µm: BLM15/18/21/31/41 	<ul style="list-style-type: none"> ■ BLM18/21/31/41 Series (Except for BLM18G Series) Coating amount is illustrated in the following diagram.
BLA	<ul style="list-style-type: none"> ● Guideline of solder paste thickness: 100-150µm: BLA2A 150-200µm: BLA31 	<ul style="list-style-type: none"> ■ BLA31 Series Coating amount is illustrated in the following diagram.

△Note • Please read rating and △CAUTION (for storage, operating, rating, soldering, mounting and handling) in this catalog to prevent smoking and/or burning, etc.
 • This catalog has only typical specifications. Therefore, please approve our product specifications or transact the approval sheet for product specifications before ordering.

Soldering and Mounting Chip Ferrite Bead
 Chip EMIFIL®
 Chip Common Mode Choke Coil
 Block Type EMIFIL®
 Microwave Absorber

3. Standard Soldering Conditions

(1) Soldering Methods

Use flow and reflow soldering methods only.
 Use standard soldering conditions when soldering chip ferrite beads.
 In cases where several different parts are soldered, each having different soldering conditions, use those conditions requiring the least heat and minimum time.

Solder: Use Sn-3.0Ag-0.5Cu solder. Use of Sn-Zn based solder will deteriorate performance of products.
 If using BLA series with Sn-Zn based solder, please contact Murata in advance.

Flux:

- Use Rosin-based flux.
 In case of using RA type solder, products should be cleaned completely with no residual flux.
- Do not use strong acidic flux (with chlorine content exceeding 0.20wt%)
- Do not use water-soluble flux.

For additional mounting methods, please contact Murata.

(2) Soldering Profile

● Flow Soldering Profile (Sn-3.0Ag-0.5Cu Solder)

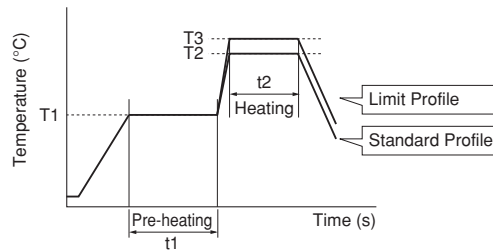

Series	Pre-heating		Standard Profile			Limit Profile		
	Temp. (T1)	Time. (t1)	Heating		Cycle of Flow	Heating		Cycle of Flow
			Temp. (T2)	Time. (t2)		Temp. (T3)	Time. (t2)	
BLM (Except for BLM02/03/15/18G) BLA31	150°C	60s min.	250°C	4 to 6s	2 times max.	265±3°C	5s max.	2 times max.

● Reflow Soldering Profile (Sn-3.0Ag-0.5Cu Solder)

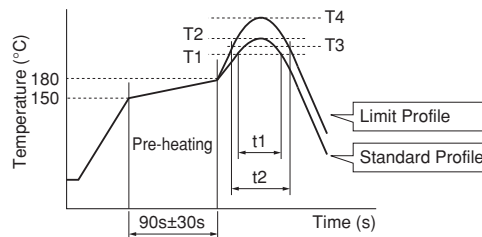

Series	Standard Profile				Limit Profile			
	Heating		Peak Temperature (T2)	Cycle of Reflow	Heating		Peak Temperature (T4)	Cycle of Reflow
	Temp. (T1)	Time. (t1)			Temp. (T3)	Time. (t2)		
BLM BLA	220°C min.	30 to 60s	245±3°C	2 times max.	230°C min.	60s max.	260°C/10s	2 times max.

△Note • Please read rating and △CAUTION (for storage, operating, rating, soldering, mounting and handling) in this catalog to prevent smoking and/or burning, etc.
 • This catalog has only typical specifications. Therefore, please approve our product specifications or transact the approval sheet for product specifications before ordering.

(3) Reworking with Solder Iron

The following conditions must be strictly followed when using a soldering iron. (Except for BLM02 Series)

Pre-heating: 150°C 60s min.

Soldering iron power output / Tip diameter:

80W max. / ø3mm max.

Temperature of soldering iron tip / Soldering time / Times:
350°C max. / 3-4s / 2 times

Do not allow the tip of the soldering iron to directly contact the chip.

For additional methods of reworking with a soldering iron, please contact Murata engineering.

4. Cleaning

Following conditions should be observed when cleaning chip ferrite beads.

(1) Cleaning Temperature: 60°C max. (40°C max. for alcohol type cleaner)

(2) Ultrasonic

Output: 20W/liter max.

Duration: 5 minutes max.

Frequency: 28 to 40kHz

(3) Cleaning Agent

The following list of cleaning agents have been tested on the individual components. Evaluation of final assembly should be completed prior to production.

(a) Alcohol cleaning agent

Isopropyl alcohol (IPA)

(b) Aqueous cleaning agent

Pine Alpha ST-100S

(4) Ensure that flux residue is completely removed.

Component should be thoroughly dried after aqueous agent has been removed with deionized water.

(5) BLM_G type is processed with resin. On rinsing the product, using water for ultrasonic cleaning may affect the resin quality used for the product by water element. In case of set cleaning conditions, please make sure the reliability according to the cleaning conditions.

■ Minimum Quantity and Dimensions of 8mm Width Paper / Embossed Tape

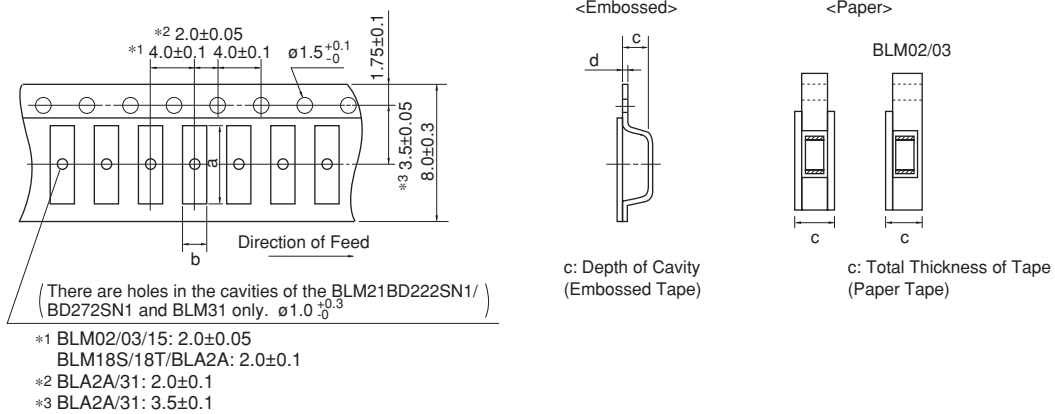

Dimension of the cavity of embossed tape is measured at the bottom side.

Part Number	Dimensions				Minimum Qty. (pcs.)				Bulk
					ø180mm Reel		ø330mm Reel		
	a	b	c	d	Paper Tape	Embossed Tape	Paper Tape	Embossed Tape	
BLM02	0.45	0.25	0.40 max.	-	20000	-	-	-	1000
BLM03	0.70	0.40	0.55 max.	-	15000	-	50000	-	1000
BLM15	1.15	0.65	0.8 max.	-	10000	-	50000	-	1000
BLM18A/B/P/R/H/G	1.85	1.05	1.1 max.	-	4000	-	10000	-	1000
BLM18EG/KG_TN	1.85	1.05	0.85 max.	-	4000	-	10000	-	1000
BLM18EG/KG_SN			1.1 max.						
BLM18S	1.85	1.05	0.90 max.	-	10000	-	30000	-	1000
BLM18T	1.85	1.05	0.90 max.	-	10000	-	-	-	1000
BLM21	2.25	1.45	1.1 max.	-	4000	-	10000	-	1000
BLM31	3.5	1.9	1.3	0.2	-	3000	-	10000	1000
BLM21BD222SN1/272SN1	2.25	1.45	1.3	0.2	-	3000	-	10000	1000
BLA2A	2.2	1.2	0.8 max.	-	10000	-	50000	-	1000
BLA31	3.4	1.8	1.1 max.	-	4000	-	10000	-	1000

(in mm)

■ Minimum Quantity and Dimensions of 12mm Width Embossed Tape

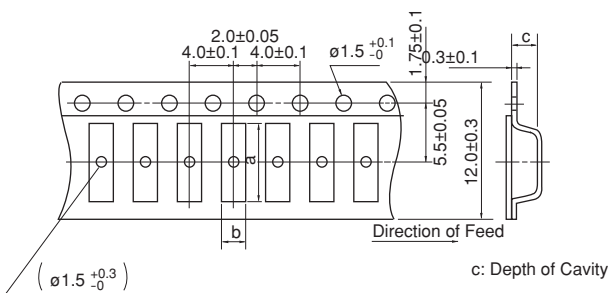

Dimension of the cavity is measured at the bottom side.

Part Number	Dimensions			Minimum Qty. (pcs.)		
	a	b	c	ø180mm Reel	ø330mm Reel	Bulk
BLM41	4.8	1.9	1.75	2500	8000	1000

(in mm)

"Minimum Quantity" means the number of units of each delivery or order. The quantity should be an integral multiple of the "Minimum Quantity."

△Note • Please read rating and △CAUTION (for storage, operating, rating, soldering, mounting and handling) in this catalog to prevent smoking and/or burning, etc.
• This catalog has only typical specifications. Therefore, please approve our product specifications or transact the approval sheet for product specifications before ordering.

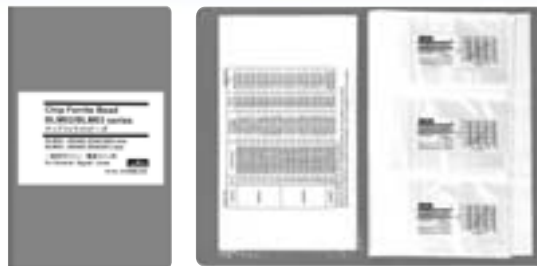

●EKEMBL03L (Chip Ferrite Beads 01005 Size / 0201 Size)

No.	Part Number	Quantity (pcs.)	Impedance typ. (at 100MHz, 20 degrees C)	Rated Current (mA)	DC Resistance (Ω) max.
1	BLM02AX100SN1	20	10Ω±5Ω	750	0.07
2	BLM02AX700SN1	20	70Ω±25%	300	0.4
3	BLM02AX121SN1	20	120Ω±25%	250	0.5
4	BLM03AG100SN1	20	10Ω (Typ.)	500	0.1
5	BLM03AG700SN1	20	70Ω (Typ.)	200	0.4
6	BLM03AG800SN1	20	80Ω±25%	200	0.4
7	BLM03AG121SN1	20	120Ω±25%	200	0.5
8	BLM03AG241SN1	20	240Ω±25%	200	0.8
9	BLM03AG601SN1	20	600Ω±25%	100	1.5
10	BLM03AG102SN1	20	1000Ω±25%	100	2.5
11	BLM03AX100SN1	20	10Ω (Typ.)	1000	0.05
12	BLM03AX800SN1	20	80Ω±25%	500	0.18
13	BLM03AX121SN1	20	120Ω±25%	450	0.23
14	BLM03AX241SN1	20	240Ω±25%	350	0.38
15	BLM03AX601SN1	20	600Ω±25%	250	0.85
16	BLM03AX102SN1	20	1000Ω±25%	200	1.25
17	BLM03BB100SN1	20	10Ω±25%	300	0.4
18	BLM03BB220SN1	20	22Ω±25%	200	0.5
19	BLM03BB470SN1	20	47Ω±25%	200	0.7
20	BLM03BB750SN1	20	75Ω±25%	200	1.0
21	BLM03BB121SN1	20	120Ω±25%	100	1.5
22	BLM03BD750SN1	20	75Ω±25%	300	0.4
23	BLM03BD121SN1	20	120Ω±25%	250	0.5
24	BLM03BD241SN1	20	240Ω±25%	200	0.8
25	BLM03BD471SN1	20	470Ω±25%	215	1.5
26	BLM03BD601SN1	20	600Ω±25%	200	1.7
27	BLM03BC330SN1	20	33Ω±25%	150	0.85
28	BLM03BC560SN1	20	56Ω±25%	100	1.05
29	BLM03BC800SN1	20	80Ω±25%	100	1.40
30	BLM03EB250SN1	20	25Ω±25%	600	0.26
31	BLM03EB500SN1	20	50Ω±25%	400	0.58
32	BLM03HG601SN1	20	600Ω±25%	150	1.6
33	BLM03HG102SN1	20	1000Ω±25%	125	2.6
34	BLM03HB191SN1	20	190Ω±25%	150	2.0
35	BLM03HD331SN1	20	330Ω±25%	200	1.0
36	BLM03HD471SN1	20	470Ω±25%	175	1.3
37	BLM03HD601SN1	20	600Ω±25%	150	1.7
38	BLM03HD102SN1	20	1000Ω±25%	120	2.9
39	BLM03PG220SN1	20	22Ω±25%	900	0.065
40	BLM03PG330SN1	20	33Ω±25%	750	0.090
41	BLM03PX220SN1	20	22Ω±25%	1800	0.040
42	BLM03PX330SN1	20	33Ω±25%	1500	0.055
43	BLM03PX800SN1	20	80Ω±25%	1000	0.130

●EKEMBL15Q (Chip Ferrite Beads 0402 Size)

No.	Part Number	Quantity (pcs.)	Impedance typ. (at 100MHz, 20 degrees C)	Rated Current (mA)	DC Resistance (Ω) max.
1	BLM15AG100SN1	20	10Ω (Typ.)	1000	0.025
2	BLM15AG700SN1	20	70Ω (Typ.)	600	0.15
3	BLM15AG121SN1	20	120Ω±25%	550	0.19
4	BLM15AG221SN1	20	220Ω±25%	450	0.29
5	BLM15AG601SN1	20	600Ω±25%	300	0.52
6	BLM15AG102SN1	20	1000Ω±25%	300	0.65
7	BLM15AX100SN1	20	10Ω (Typ.)	1740	0.015
8	BLM15AX300SN1	20	30Ω±25%	1100	0.06

Continued on the following page.

△Note • Please read rating and △CAUTION (for storage, operating, rating, soldering, mounting and handling) in this catalog to prevent smoking and/or burning, etc.
• This catalog has only typical specifications. Therefore, please approve our product specifications or transact the approval sheet for product specifications before ordering.

Design Kits
Chip Ferrite Bead

Chip EMIFIL®

Chip Common Mode Choke Coil

Block Type EMIFIL®

Microwave Absorber

Continued from the preceding page.

No.	Part Number	Quantity (pcs.)	Impedance typ. (at 100MHz, 20 degrees C)	Rated Current (mA)	DC Resistance (Ω) max.
9	BLM15AX700SN1	20	70 Ω ±25%	780	0.10
10	BLM15AX121SN1	20	120 Ω ±25%	700	0.13
11	BLM15AX221SN1	20	220 Ω ±25%	600	0.18
12	BLM15AX601SN1	20	600 Ω ±25%	500	0.34
13	BLM15AX102SN1	20	1000 Ω ±25%	350	0.49
14	BLM15BA050SN1	20	5 Ω ±25%	300	0.10
15	BLM15BA100SN1	20	10 Ω ±25%	300	0.20
16	BLM15BA220SN1	20	22 Ω ±25%	300	0.30
17	BLM15BA330SN1	20	33 Ω ±25%	300	0.40
18	BLM15BA470SN1	20	47 Ω ±25%	200	0.60
19	BLM15BA750SN1	20	75 Ω ±25%	200	0.80
20	BLM15BB050SN1	20	5 Ω ±25%	500	0.08
21	BLM15BB100SN1	20	10 Ω ±25%	300	0.10
22	BLM15BB220SN1	20	22 Ω ±25%	300	0.20
23	BLM15BB470SN1	20	47 Ω ±25%	300	0.35
24	BLM15BB750SN1	20	75 Ω ±25%	300	0.40
25	BLM15BB121SN1	20	120 Ω ±25%	300	0.55
26	BLM15BB221SN1	20	220 Ω ±25%	200	0.80
27	BLM15BC121SN1	20	120 Ω ±25%	350	0.45
28	BLM15BC241SN1	20	240 Ω ±25%	250	0.70
29	BLM15BD750SN1	20	75 Ω ±25%	300	0.20
30	BLM15BD121SN1	20	120 Ω ±25%	300	0.30
31	BLM15BD221SN1	20	220 Ω ±25%	300	0.40
32	BLM15BD471SN1	20	470 Ω ±25%	200	0.60
33	BLM15BD601SN1	20	600 Ω ±25%	200	0.65
34	BLM15BD102SN1	20	1000 Ω ±25%	200	0.90
35	BLM15BD182SN1	20	1800 Ω ±25%	100	1.40
36	BLM15BX750SN1	20	75 Ω ±25%	600	0.15
37	BLM15BX121SN1	20	120 Ω ±25%	600	0.17
38	BLM15BX221SN1	20	220 Ω ±25%	450	0.27
39	BLM15BX471SN1	20	470 Ω ±25%	350	0.41
40	BLM15BX601SN1	20	600 Ω ±25%	350	0.46
41	BLM15BX102SN1	20	1000 Ω ±25%	300	0.65
42	BLM15BX182SN1	20	1800 Ω ±25%	250	0.90
43	BLM15HD601SN1	20	600 Ω ±25%	300	0.85
44	BLM15HD102SN1	20	1000 Ω ±25%	250	1.25
45	BLM15HD182SN1	20	1800 Ω ±25%	200	2.20
46	BLM15HG601SN1	20	600 Ω ±25%	300	0.70
47	BLM15HG102SN1	20	1000 Ω ±25%	250	1.10
48	BLM15HB121SN1	20	120 Ω ±25%	300	0.70
49	BLM15HB221SN1	20	220 Ω ±25%	250	1.00
50	BLM15EG121SN1	20	120 Ω ±25%	1500	0.095
51	BLM15EG221SN1	20	220 Ω ±25%	700	0.28
52	BLM15GG221SN1	20	220 Ω ±25%	300	0.70
53	BLM15GG471SN1	20	470 Ω ±25%	200	1.30
54	BLM15GA750SN1	20	75 Ω ±25%	200	1.30
55	BLM15PG100SN1	20	10 Ω (Typ.)	1000	0.025
56	BLM15PD300SN1	20	30 Ω ±25%	2200	0.035
57	BLM15PD600SN1	20	60 Ω ±25%	1700	0.06
58	BLM15PD800SN1	20	80 Ω ±25%	1500	0.07
59	BLM15PD121SN1	20	120 Ω ±25%	1300	0.09
60	BLM15PX330SN1	20	33 Ω ±25%	3000	0.022
61	BLM15PX600SN1	20	60 Ω ±25%	2500	0.032
62	BLM15PX800SN1	20	80 Ω ±25%	2300	0.038
63	BLM15PX121SN1	20	120 Ω ±25%	2000	0.055
64	BLM15PX181SN1	20	180 Ω ±25%	1500	0.090
65	BLM15PX221SN1	20	220 Ω ±25%	1400	0.10
66	BLM15PX331SN1	20	330 Ω ±25%	1200	0.15
67	BLM15PX471SN1	20	470 Ω ±25%	1000	0.20
68	BLM15PX601SN1	20	600 Ω ±25%	900	0.23

⚠Note • Please read rating and ⚠CAUTION (for storage, operating, rating, soldering, mounting and handling) in this catalog to prevent smoking and/or burning, etc.
 • This catalog has only typical specifications. Therefore, please approve our product specifications or transact the approval sheet for product specifications before ordering.

●EKEMBL18J (Chip Ferrite Beads 0603 Size)

No.	Part Number	Quantity (pcs.)	Impedance typ. (at 100MHz, 20 degrees C)	Rated Current (mA)	DC Resistance (Ω) max.
1	BLM18AG121SN1	20	120Ω±25%	500	0.18
2	BLM18AG151SN1	20	150Ω±25%	500	0.25
3	BLM18AG221SN1	20	220Ω±25%	500	0.25
4	BLM18AG331SN1	20	330Ω±25%	500	0.30
5	BLM18AG471SN1	20	470Ω±25%	500	0.35
6	BLM18AG601SN1	20	600Ω±25%	500	0.38
7	BLM18AG102SN1	20	1000Ω±25%	400	0.50
8	BLM18BA050SN1	20	5Ω±25%	500	0.20
9	BLM18BA100SN1	20	10Ω±25%	500	0.25
10	BLM18BA470SN1	20	47Ω±25%	300	0.55
11	BLM18BA750SN1	20	75Ω±25%	300	0.70
12	BLM18BA121SN1	20	120Ω±25%	200	0.90
13	BLM18BB050SN1	20	5Ω±25%	700	0.05
14	BLM18BB100SN1	20	10Ω±25%	700	0.10
15	BLM18BB220SN1	20	22Ω±25%	600	0.20
16	BLM18BB470SN1	20	47Ω±25%	550	0.25
17	BLM18BB600SN1	20	60Ω±25%	550	0.25
18	BLM18BB750SN1	20	75Ω±25%	500	0.30
19	BLM18BB121SN1	20	120Ω±25%	500	0.30
20	BLM18BB151SN1	20	150Ω±25%	450	0.37
21	BLM18BB221SN1	20	220Ω±25%	450	0.45
22	BLM18BB331SN1	20	330Ω±25%	400	0.58
23	BLM18BB471SN1	20	470Ω±25%	300	0.85
24	BLM18BD470SN1	20	47Ω±25%	500	0.30
25	BLM18BD121SN1	20	120Ω±25%	200	0.40
26	BLM18BD151SN1	20	150Ω±25%	200	0.40
27	BLM18BD221SN1	20	220Ω±25%	200	0.45
28	BLM18BD331SN1	20	330Ω±25%	200	0.50
29	BLM18BD421SN1	20	420Ω±25%	200	0.55
30	BLM18BD471SN1	20	470Ω±25%	200	0.55
31	BLM18BD601SN1	20	600Ω±25%	200	0.65
32	BLM18BD102SN1	20	1000Ω±25%	100	0.85
33	BLM18BD152SN1	20	1500Ω±25%	50	1.20
34	BLM18BD182SN1	20	1800Ω±25%	50	1.50
35	BLM18BD222SN1	20	2200Ω±25%	50	1.50
36	BLM18BD252SN1	20	2500Ω±25%	50	1.50
37	BLM18PG300SN1	20	30Ω (Typ.)	1000	0.05
38	BLM18PG330SN1	20	33Ω±25%	3000	0.025
39	BLM18PG600SN1	20	60Ω (Typ.)	500	0.10
40	BLM18PG121SN1	20	120Ω±25%	2000	0.05
41	BLM18PG181SN1	20	180Ω±25%	1500	0.09
42	BLM18PG221SN1	20	220Ω±25%	1400	0.10
43	BLM18PG331SN1	20	330Ω±25%	1200	0.15
44	BLM18PG471SN1	20	470Ω±25%	1000	0.20
45	BLM18KG260TN1	20	26Ω±25%	6000	0.007
46	BLM18KG300TN1	20	30Ω±25%	5000	0.010
47	BLM18KG700TN1	20	70Ω±25%	3500	0.022
48	BLM18KG101TN1	20	100Ω±25%	3000	0.030
49	BLM18KG121TN1	20	120Ω±25%	3000	0.030
50	BLM18KG221SN1	20	220Ω±25%	2200	0.050
51	BLM18KG331SN1	20	330Ω±25%	1700	0.080
52	BLM18KG471SN1	20	470Ω±25%	1500	0.130
53	BLM18KG601SN1	20	600Ω±25%	1300	0.150
54	BLM18SG260TN1	20	26Ω±25%	6000	0.007
55	BLM18SG700TN1	20	70Ω±25%	4000	0.020
56	BLM18SG121TN1	20	120Ω±25%	3000	0.025
57	BLM18SG221TN1	20	220Ω±25%	2500	0.040
58	BLM18SG331TN1	20	330Ω±25%	1500	0.070

●EKEMBL8GB (Chip Ferrite Beads 0603 Size / for High Frequency Type)

No.	Part Number	Quantity (pcs.)	Impedance (at 100MHz, 20 degrees C)	Impedance (at 1GHz, 20 degrees C)	Rated Current (mA)	DC Resistance (Ω) max.
1	BLM18HG471SN1	20	470Ω±25%	600Ω (Typ.)	200	0.85
2	BLM18HG601SN1	20	600Ω±25%	700Ω (Typ.)	200	1.00
3	BLM18HG102SN1	20	1000Ω±25%	1000Ω (Typ.)	100	1.60

Continued on the following page.

△Note • Please read rating and △CAUTION (for storage, operating, rating, soldering, mounting and handling) in this catalog to prevent smoking and/or burning, etc.
 • This catalog has only typical specifications. Therefore, please approve our product specifications or transact the approval sheet for product specifications before ordering.

Design Kits
Chip Ferrite Bead

Chip EMIFIL®

Chip Common Mode Choke Coil

Block Type EMIFIL®

Microwave Absorber

Continued from the preceding page.

No.	Part Number	Quantity (pcs.)	Impedance (at 100MHz, 20 degrees C)	Impedance (at 1GHz, 20 degrees C)	Rated Current (mA)	DC Resistance (Ω) max.
4	BLM18HB121SN1	20	120Ω±25%	500Ω±40%	200	0.50
5	BLM18HB221SN1	20	220Ω±25%	1100Ω±40%	100	0.80
6	BLM18HB331SN1	20	330Ω±25%	1600Ω±40%	50	1.20
7	BLM18HD471SN1	20	470Ω±25%	1000Ω (Typ.)	100	1.20
8	BLM18HD601SN1	20	600Ω±25%	1200Ω (Typ.)	100	1.50
9	BLM18HD102SN1	20	1000Ω±25%	1700Ω (Typ.)	50	1.80
10	BLM18HE601SN1	20	600Ω±25%	600Ω (Typ.)	800	0.25
11	BLM18HE102SN1	20	1000Ω±25%	1000Ω (Typ.)	600	0.35
12	BLM18HE152SN1	20	1500Ω±25%	1500Ω (Typ.)	500	0.50
13	BLM18HK331SN1	20	330Ω±25%	400Ω (Typ.)	200	0.50
14	BLM18HK471SN1	20	470Ω±25%	600Ω (Typ.)	200	0.70
15	BLM18HK601SN1	20	600Ω±25%	700Ω (Typ.)	100	0.90
16	BLM18HK102SN1	20	1000Ω±25%	1200Ω (Typ.)	50	1.50
17	BLM18EG101TN1	20	100Ω±25%	140Ω (Typ.)	2000	0.045
18	BLM18EG121SN1	20	120Ω±25%	145Ω (Typ.)	2000	0.04
19	BLM18EG221TN1	20	220Ω±25%	300Ω (Typ.)	1000	0.15
20	BLM18EG221SN1	20	220Ω±25%	260Ω (Typ.)	2000	0.05
21	BLM18EG331TN1	20	330Ω±25%	450Ω (Typ.)	500	0.21
22	BLM18EG391TN1	20	390Ω±25%	520Ω (Typ.)	500	0.30
23	BLM18EG471SN1	20	470Ω±25%	550Ω (Typ.)	500	0.21
24	BLM18EG601SN1	20	600Ω±25%	700Ω (Typ.)	500	0.35
25	BLM18GG471SN1	20	470Ω±25%	1800Ω±30%	200	1.30

●EKEMBL21F (Chip Ferrite Beads 0805 Size / for Large-current P Type)

No.	Part Number	Quantity (pcs.)	Impedance typ. (at 100MHz, 20 degrees C)	Rated Current (mA)	DC Resistance (Ω) max.
1	BLM21AG121SN1	20	120Ω±25%	800	0.10
2	BLM21AG151SN1	20	150Ω±25%	800	0.10
3	BLM21AG221SN1	20	220Ω±25%	800	0.13
4	BLM21AG331SN1	20	330Ω±25%	700	0.16
5	BLM21AG471SN1	20	470Ω±25%	700	0.19
6	BLM21AG601SN1	20	600Ω±25%	600	0.21
7	BLM21AG102SN1	20	1000Ω±25%	500	0.28
8	BLM21BB050SN1	20	5Ω±25%	1000	0.02
9	BLM21BB600SN1	20	60Ω±25%	800	0.13
10	BLM21BB750SN1	20	75Ω±25%	700	0.16
11	BLM21BB121SN1	20	120Ω±25%	600	0.19
12	BLM21BB221SN1	20	220Ω±25%	500	0.26
13	BLM21BB331SN1	20	330Ω±25%	400	0.33
14	BLM21BB471SN1	20	470Ω±25%	400	0.40
15	BLM21BD121SN1	20	120Ω±25%	200	0.25
16	BLM21BD221SN1	20	220Ω±25%	200	0.25
17	BLM21BD421SN1	20	420Ω±25%	200	0.30
18	BLM21BD471SN1	20	470Ω±25%	200	0.35
19	BLM21BD601SN1	20	600Ω±25%	200	0.35
20	BLM21BD102SN1	20	1000Ω±25%	200	0.40
21	BLM21BD152SN1	20	1500Ω±25%	200	0.45
22	BLM21BD182SN1	20	1800Ω±25%	200	0.50
23	BLM21BD222SN1	20	2250Ω (Typ.)	200	0.60
24	BLM21BD222TN1	20	2200Ω±25%	200	0.60
25	BLM21BD272SN1	20	2700Ω±25%	200	0.80
26	BLM21PG220SN1	20	22Ω±25%	6000	0.009
27	BLM21PG300SN1	20	30Ω (Typ.)	4000	0.014
28	BLM21PG600SN1	20	60Ω±25%	3500	0.02
29	BLM21PG121SN1	20	120Ω±25%	3000	0.03
30	BLM21PG221SN1	20	220Ω±25%	2000	0.045
31	BLM21PG331SN1	20	330Ω±25%	1500	0.07
32	BLM31PG330SN1	20	33Ω±25%	6000	0.009
33	BLM31PG500SN1	20	50Ω (Typ.)	3500	0.015
34	BLM31PG121SN1	20	120Ω±25%	3500	0.02
35	BLM31PG391SN1	20	390Ω (Typ.)	2000	0.05
36	BLM31PG601SN1	20	600Ω (Typ.)	1500	0.08
37	BLM41PG600SN1	20	60Ω (Typ.)	6000	0.009
38	BLM41PG750SN1	20	75Ω (Typ.)	3500	0.015
39	BLM41PG181SN1	20	180Ω (Typ.)	3500	0.02

Continued on the following page.

⚠Note • Please read rating and ⚠CAUTION (for storage, operating, rating, soldering, mounting and handling) in this catalog to prevent smoking and/or burning, etc.
 • This catalog has only typical specifications. Therefore, please approve our product specifications or transact the approval sheet for product specifications before ordering.

Continued from the preceding page.

No.	Part Number	Quantity (pcs.)	Impedance typ. (at 100MHz, 20 degrees C)	Rated Current (mA)	DC Resistance (Ω) max.
40	BLM41PG471SN1	20	470Ω (Typ.)	2000	0.05
41	BLM41PG102SN1	20	1000Ω (Typ.)	1500	0.09

Design Kits
Chip Ferrite Bead

Chip EMIFIL®

Chip Common Mode Choke Coil

Block Type EMIFIL®

Microwave Absorber

△Note • Please read rating and △CAUTION (for storage, operating, rating, soldering, mounting and handling) in this catalog to prevent smoking and/or burning, etc.
• This catalog has only typical specifications. Therefore, please approve our product specifications or transact the approval sheet for product specifications before ordering.



Chip EMIFIL®

Series Introduction	108
Part Numbering	110
Series Line Up	113
Product Detail	116
⚠Caution/Notice	146
Soldering and Mounting	147
Packaging	153
Design Kits	155

Chip Ferrite Bead

Chip EMIFIL®

Chip Common Mode Choke Coil

Block Type EMIFIL®

Microwave Absorber

⚠Note • Please read rating and ⚠CAUTION (for storage, operating, rating, soldering, mounting and handling) in this catalog to prevent smoking and/or burning, etc.
• This catalog has only typical specifications. Therefore, please approve our product specifications or transact the approval sheet for product specifications before ordering.

NF Series Introduction

Chip Ferrite Bead

Chip EMIFIL®

Chip Common Mode Choke Coil

Block Type EMIFIL®



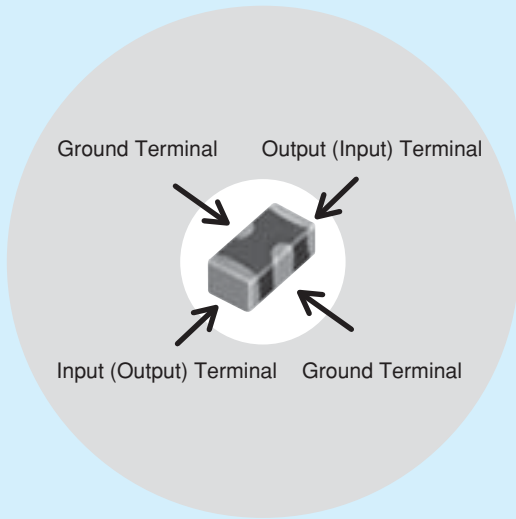





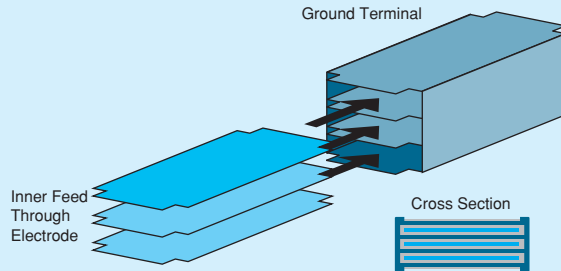







Microwave Absorber



Example of 3-Terminal Capacitor Structure

Chip 3-terminal capacitor is a chip-shaped 3-terminal capacitor designed for noise suppression. Its inner structure, like a feed-through capacitor, makes its ground impedance quite low. Owing to this structure, the 3-terminal capacitor has a good noise suppression effect at a high frequency range up to several hundred MHz.



Series	Equivalent Circuit	Part Number
NFM Series (3-terminal capacitor)		 NFM18CC
		 NFM21CC
		 NFM18PC
		 NFM18PS
		 NFM21PC
NFL / NFW Series (LC filter)		 NFL15ST
		 NFL18ST
		 NFL18SP  NFL21SP  NFW31SP
NFA Series		 NFA21S
		 NFA18S
NFR Series (RC filter)		 NFR21GD  NFA31GD
NFE Series (Feed through capacitor with ferrite cores)		 NFE31PT  NFE61PT

△Note • Please read rating and △CAUTION (for storage, operating, rating, soldering, mounting and handling) in this catalog to prevent smoking and/or burning, etc.
• This catalog has only typical specifications. Therefore, please approve our product specifications or transact the approval sheet for product specifications before ordering.

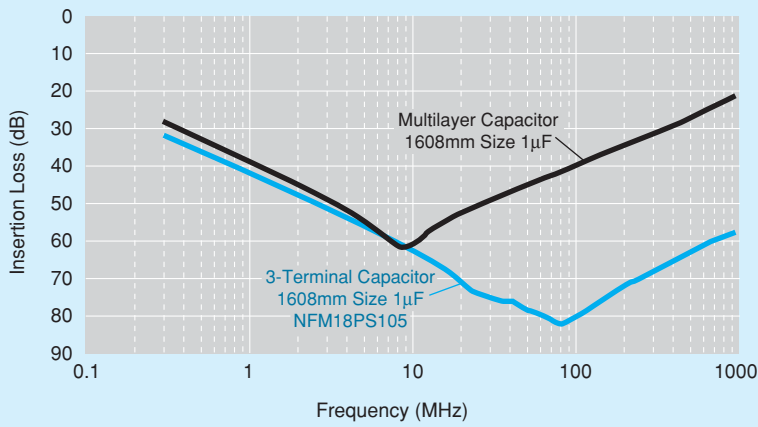

Insertion Loss Sample	Features	Classification		Applications	Example
		Code	Description		
	Standard of 3-terminal capacitor	NFM_CC	Standard type with varied capacitance	Noise suppression in low speed signal lines	<ul style="list-style-type: none"> Low speed interface lines Sensor
		NFM_PC	Meet large current, high capacitance available, for power lines	Noise suppression in power lines	<ul style="list-style-type: none"> Individual IC power lines
	Sharp insertion loss curve enables low damage to signal waveform	NFL_ST	T-type filter, effective in low impedance circuits	Noise suppression in high speed signal lines	<ul style="list-style-type: none"> High speed interface lines Bus lines LCD lines Camera I/Fs High speed analog lines RGB / D terminal
		NFL_SP	π-type filter, effective in high impedance circuits		
		NFW_SP	π-type filter, designed for low impedance circuits		
		NFA_SL	4-line array, suitable for bus lines or flat cables		
	Limit noise using resistor, also loop back to ground			Noise suppression in signal line with unstable ground	<ul style="list-style-type: none"> Interface lines Clock lines
	Meets large current, good high frequency performance because of its feed through structure			Noise suppression in power lines / low impedance lines	<ul style="list-style-type: none"> Various power lines Sensor

Chip Ferrite Bead

Chip EMIFIL®

Chip Common Mode Choke Coil

Block Type EMIFIL®

Microwave Absorber

⚠Note • Please read rating and ⚠CAUTION (for storage, operating, rating, soldering, mounting and handling) in this catalog to prevent smoking and/or burning, etc.
 • This catalog has only typical specifications. Therefore, please approve our product specifications or transact the approval sheet for product specifications before ordering.

NF Chip EMIFIL® Part Numbering

Capacitor

(Part Number)

NF	M	3D	CC	102	R	1H	3	L
①	②	③	④	⑤	⑥	⑦	⑧	⑨

*NFA□□SL/SD Series, please refer to p.112 (LC Combined (2)).

*NFA□□GD Series, please refer to p.112 (RC Combined).

① Product ID

Product ID	
NF	Chip EMIFIL®

② Structure

Code	Structure
M	Capacitor Type
A	Capacitor Array Type

③ Dimensions (L×W)

Code	Dimensions (L×W)	EIA
18	1.6×0.8mm	0603
21	2.0×1.25mm	0805
3D	3.2×1.25mm	1205
31	3.2×1.6mm	1206
41	4.5×1.6mm	1806

④ Features

Code	Features
CC	Capacitor Type for Signal Lines
PC	Capacitor Type for Large Current
PS	High Insertion Loss Type for Large Current
KC	Capacitor Type for Very Large Current

⑤ Capacitance

Expressed by three figures. The unit is in pico-farad (pF). The first and second figures are significant digits, and the third figure expresses the number of zeros that follow the two figures.

⑨ Packaging

Code	Packaging	Series
L	Embossed Taping (ø180mm Reel)	NFM3D/NFM31/NFM41
B	Bulk	All series
D	Paper Taping (ø180mm Reel)	NFM18/NFM21/NFA□□CC

⑥ Characteristics

Code	Capacitance Change (Temperature Characteristics)
B	±10%, ±12.5%, +10/-13%
F	+30/-80%, +30/-84%
R	±15%, +15/-18%
U	-750 ±120ppm/°C
S	+350 to -1000ppm/°C

⑦ Rated Voltage

Code	Rated Voltage
0J	6.3V
1A	10V
1C	16V
1E	25V
1H	50V
2A	100V

⑧ Electrode/Others (NFM Series)

Code	Electrode	Series
3	Sn Plating	NFM

⑧ Number of Circuits (NFA□□CC Series)

Code	Number of Circuits
4	4 Circuits

LC Combined (1)

(Part Number)

NF	L	18	ST	107	X	1C	3	L
①	②	③	④	⑤	⑥	⑦	⑧	⑨

① Product ID

Product ID	
NF	Chip EMIFIL®

② Structure

Code	Structure
L	Multilayer, LC Combined Type
W	Wire Wound, LC Combined Type
E	Block, LC Combined Type

③ Dimensions (L×W)

Code	Dimensions (L×W)	EIA
15	1.0×0.5mm	0402
18	1.6×0.8mm	0603
21	2.0×1.25mm	0805
31	3.2×1.6mm	1206
61	6.8×1.6mm	2706

④ Features

Code	Features
SP	π Circuit for Signal Lines
ST	T Circuit for Signal Lines
PT	T Circuit for Large Current

⑤ Cut-off Frequency (NFL/NFW Series)

Expressed by three figures. The unit is in hertz (Hz). The first and second figures are significant digits, and the third figure expresses the number of zeros that follow the two figures.

⑤ Capacitance (NFE Series)

Expressed by three figures. The unit is in pico-farad (pF). The first and second figures are significant digits, and the third figure expresses the number of zeros that follow the two figures.

⑨ Packaging

Code	Packaging	Series
K	Embossed Taping (ø330mm Reel)	NFW31/NFE
L	Embossed Taping (ø180mm Reel)	NFW31/NFE
B	Bulk	NFL18/NFL21/NFE
D	Paper Taping (ø180mm Reel)	NFL15/NFL18/NFL21

⑥ Characteristics (NFL/NFW Series)

Code	Characteristics
H/X	Cut-off Frequency

⑥ Characteristics (NFE Series)

Code	Capacitance Change (Temperature Characteristics)
B	±10%
C	±20%, ±22%
D	+20/-30%, +22/-33%
E	+20/-55%, +22/-56%
F	+30/-80%, +22/-82%
R	±15%
U	-750 ±120ppm/ °C
Z	Other

⑦ Rated Voltage

Code	Rated Voltage
1A	10V
1C	16V
1E	25V
1H	50V
2A	100V

⑧ Electrode

Code	Electrode	Series
3/7	Sn Plating	NFL
4	Lead Free Solder Coating	NFW
9	Others	NFE

△Note • Please read rating and △CAUTION (for storage, operating, rating, soldering, mounting and handling) in this catalog to prevent smoking and/or burning, etc.
• This catalog has only typical specifications. Therefore, please approve our product specifications or transact the approval sheet for product specifications before ordering.

LC Combined (2)

(Part Number)

NF	A	21	SL	207	X	1A	4	5	L
①	②	③	④	⑤	⑥	⑦	⑧	⑨	⑩

*NFA□□CC Series, please refer to p.110.

*NFA□□GD Series, please refer to p.112 (RC Combined).

① Product ID

Product ID	
NF	Chip EMIFIL®

② Structure

Code	Structure
A	Array Type

③ Dimensions (L×W)

Code	Dimensions (L×W)	EIA
18	1.6×0.8mm	0603
21	2.0×1.25mm	0805

④ Features (1)

Code	Features
SL	L Circuit for Signal Lines
SD	L Circuit for Differential Signal

⑤ Cut-off Frequency

Expressed by three figures. The unit is in hertz (Hz). The first and second figures are significant digits, and the third figure expresses the number of zeros that follow the two figures.

⑥ Features (2)

Code	Features
X	Expressed by a letter
V	

⑦ Rated Voltage

Code	Rated Voltage
1A	10V

⑧ Number of Circuits

Code	Number of Circuits
4	4 Circuits

⑨ Dimensions (T)

Code	Dimensions (T)
5	Low Profile
8	Standard

⑩ Packaging

Code	Packaging
B	Bulk
L	Embossed Taping (ø180mm Reel)

RC Combined

(Part Number)

NF	R	21	GD	470	470	2	L
①	②	③	④	⑤	⑥	⑦	⑧

*NFA□□CC Series, please refer to p.110.

*NFA□□SL/SD Series, please refer to p.112 (LC Combined (2)).

① Product ID

Product ID	
NF	Chip EMIFIL®

② Structure

Code	Structure
R	RC Combined Type
A	RC Combined Array Type

③ Dimensions (L×W)

Code	Dimensions (L×W)	EIA
21	2.0×1.25mm	0805
31	3.2×1.6mm	1206

④ Features

Code	Features
GD	RC Combined Type for Signal Lines

⑧ Packaging

Code	Packaging	Series
L	Embossed Taping (ø180mm Reel)	NFR
B	Bulk	All Series
D	Paper Taping (ø180mm Reel)	NFA□□GD

⑤ Capacitance

Expressed by three figures. The unit is in pico-farad (pF). The first and second figures are significant digits, and the third figure expresses the number of zeros that follow the two figures.

⑥ Resistance

Expressed by three-digit alphanumerics. The unit is in ohm (Ω). The first and second figures are significant digits, and the third figure expresses the number of zeros that follow the two figures. If there is a decimal point, it is expressed by the capital letter "R." In this case, all figures are significant digits.

⑦ Electrode/Others (NFR Series)

Code	Electrode
2	Sn Plating

⑦ Number of Circuits (NFA□□GD Series)

Code	Number of Circuits
4	4 Circuits

△Note • Please read rating and △CAUTION (for storage, operating, rating, soldering, mounting and handling) in this catalog to prevent smoking and/or burning, etc.
• This catalog has only typical specifications. Therefore, please approve our product specifications or transact the approval sheet for product specifications before ordering.

Type	Size Code (Inch)	Thickness (mm)	Part Number	Rated Voltage	Capacitance	Nominal Cut-off Frequency	Rated Current	New	Kit	$\geq 1A$	$\geq 3A$	$\geq 10A$	DTV	Flow	RefFlow		
Capacitor Type for Signal Lines	p127	0.6	NFM18CC220U1C3	16Vdc	22pF+20%-20%	-	400mA		Kit							RefFlow	
		0.6	NFM18CC470U1C3	16Vdc	47pF+20%-20%	-	400mA		Kit								RefFlow
		0.6	NFM18CC101R1C3	16Vdc	100pF+20%-20%	-	500mA		Kit								RefFlow
		0.6	NFM18CC221R1C3	16Vdc	220pF+20%-20%	-	500mA		Kit								RefFlow
		0.6	NFM18CC471R1C3	16Vdc	470pF+20%-20%	-	500mA		Kit								RefFlow
		0.6	NFM18CC102R1C3	16Vdc	1000pF+20%-20%	-	600mA		Kit								RefFlow
		0.6	NFM18CC222R1C3	16Vdc	2200pF+20%-20%	-	700mA		Kit								RefFlow
	0603	0.6	NFM18CC223R1C3	16Vdc	2200pF+20%-20%	-	1000mA		Kit								RefFlow
		p128	0.85	NFM21CC220U1H3	50Vdc	22pF+20%-20%	-	700mA		Kit		$\geq 1A$					RefFlow
			0.85	NFM21CC470U1H3	50Vdc	47pF+20%-20%	-	700mA		Kit							RefFlow
			0.85	NFM21CC101U1H3	50Vdc	100pF+20%-20%	-	700mA		Kit							RefFlow
			0.85	NFM21CC221R1H3	50Vdc	220pF+20%-20%	-	700mA		Kit							RefFlow
			0.85	NFM21CC471R1H3	50Vdc	470pF+20%-20%	-	1000mA		Kit		$\geq 1A$					RefFlow
			0.85	NFM21CC102R1H3	50Vdc	1000pF+20%-20%	-	1000mA		Kit		$\geq 1A$					RefFlow
	0.85		NFM21CC222R1H3	50Vdc	2200pF+20%-20%	-	1000mA		Kit		$\geq 1A$					RefFlow	
	0805	0.85	NFM21CC223R1H3	50Vdc	2200pF+20%-20%	-	2000mA		Kit		$\geq 1A$					RefFlow	
		p129	0.7	NFM3DCC220U1H3	50Vdc	22pF+50%-20%	-	300mA							Flow	RefFlow	
			0.7	NFM3DCC470U1H3	50Vdc	47pF+50%-20%	-	300mA							Flow	RefFlow	
			0.7	NFM3DCC101U1H3	50Vdc	100pF+50%-20%	-	300mA							Flow	RefFlow	
			0.7	NFM3DCC221R1H3	50Vdc	220pF+50%-20%	-	300mA							Flow	RefFlow	
			0.7	NFM3DCC471R1H3	50Vdc	470pF+50%-20%	-	300mA							Flow	RefFlow	
			0.7	NFM3DCC102R1H3	50Vdc	1000pF+50%-20%	-	300mA							Flow	RefFlow	
	0.7		NFM3DCC222R1H3	50Vdc	2200pF+50%-20%	-	300mA							Flow	RefFlow		
	1205	0.7	NFM3DCC223R1H3	50Vdc	2200pF+50%-20%	-	300mA							Flow	RefFlow		
		p130	1.0	NFM41CC220U2A3	100Vdc	22pF+50%-20%	-	300mA							Flow	RefFlow	
			1.0	NFM41CC470U2A3	100Vdc	47pF+50%-20%	-	300mA							Flow	RefFlow	
			1.0	NFM41CC101U2A3	100Vdc	100pF+50%-20%	-	300mA							Flow	RefFlow	
			1.0	NFM41CC221U2A3	100Vdc	220pF+50%-20%	-	300mA							Flow	RefFlow	
1.0			NFM41CC471R2A3	100Vdc	470pF+50%-20%	-	300mA							Flow	RefFlow		
1.0			NFM41CC102R2A3	100Vdc	1000pF+50%-20%	-	300mA							Flow	RefFlow		
1.0	NFM41CC222R2A3		100Vdc	2200pF+50%-20%	-	300mA							Flow	RefFlow			
1806	1.0	NFM41CC223R2A3	100Vdc	2200pF+50%-20%	-	300mA							Flow	RefFlow			
	p131	0.8	NFA31CC220S1E4	25Vdc	22pF+20%-20%	-	200mA		Kit							RefFlow	
		0.8	NFA31CC470S1E4	25Vdc	47pF+20%-20%	-	200mA		Kit							RefFlow	
		0.8	NFA31CC101S1E4	25Vdc	100pF+20%-20%	-	200mA		Kit							RefFlow	
		0.8	NFA31CC221S1E4	25Vdc	220pF+20%-20%	-	200mA		Kit							RefFlow	
		0.8	NFA31CC471R1E4	25Vdc	470pF+20%-20%	-	200mA		Kit							RefFlow	
		0.8	NFA31CC102R1E4	25Vdc	1000pF+20%-20%	-	200mA		Kit							RefFlow	
0.8		NFA31CC222R1E4	25Vdc	2200pF+20%-20%	-	200mA		Kit							RefFlow		
1206	0.8	NFA31CC223R1C4	16Vdc	2200pF+20%-20%	-	200mA		Kit							RefFlow		

Continued on the following page.

⚠Note • Please read rating and ⚠CAUTION (for storage, operating, rating, soldering, mounting and handling) in this catalog to prevent smoking and/or burning, etc.
• This catalog has only typical specifications. Therefore, please approve our product specifications or transact the approval sheet for product specifications before ordering.

Type	Size Code (Inch)	Thickness (mm)	Part Number	Rated Voltage	Capacitance	Nominal Cut-off Frequency	Rated Current	New	Kit	≥1A	≥3A	≥10A	DTV	Flow	RefFlow	
Capacitor Type for Power Lines	0603	p118	NFM18PS474R0J3	6.3Vdc	0.47μF+20%-20%	-	2A		Kit	≥1A					RefFlow	
			NFM18PS105R0J3	6.3Vdc	1.0μF+20%-20%	-	2A		Kit	≥1A					RefFlow	
		p119	NFM18PC104R1C3	16Vdc	0.1μF+20%-20%	-	2A		Kit	≥1A						RefFlow
			NFM18PC224R0J3	6.3Vdc	0.22μF+20%-20%	-	2A		Kit	≥1A						RefFlow
			NFM18PC474R0J3	6.3Vdc	0.47μF+20%-20%	-	2A		Kit	≥1A						RefFlow
			NFM18PC105R0J3	6.3Vdc	1.0μF+20%-20%	-	4A		Kit	≥1A						RefFlow
	0805	NFM18PC225B0J3	6.3Vdc	2.2μF+20%-20%	-	2A		Kit	≥1A						RefFlow	
		NFM18PC225B1A3	10Vdc	2.2μF+20%-20%	-	4A		Kit	≥3A						RefFlow	
		p121	NFM21PS106B0J3	6.3Vdc	10μF+20%-20%	-	4A		Kit	≥3A						RefFlow
			p122	NFM21PC104R1E3	25Vdc	0.1μF+20%-20%	-	2A		Kit	≥1A					
		NFM21PC224R1C3		16Vdc	0.22μF+20%-20%	-	2A		Kit	≥1A						RefFlow
		NFM21PC474R1C3		16Vdc	0.47μF+20%-20%	-	2A		Kit	≥1A						RefFlow
		NFM21PC105B1A3		10Vdc	1.0μF+20%-20%	-	4A		Kit	≥3A						RefFlow
		NFM21PC105B1C3		16Vdc	1.0μF+20%-20%	-	4A		Kit	≥3A						RefFlow
	NFM21PC225B0J3	6.3Vdc		2.2μF+20%-20%	-	4A		Kit	≥3A						RefFlow	
	NFM21PC475B1A3	10Vdc	4.7μF+20%-20%	-	6A		Kit	≥3A						RefFlow		
	1205	p123	NFM3DPC223R1H3	50Vdc	0.022μF+20%-20%	-	2A			Kit	≥1A			Flow	RefFlow	
	1206	p124	NFM31PC276B0J3	6.3Vdc	27μF+20%-20%	-	6A		Kit	≥3A				Flow	RefFlow	
			p125	NFM31KC103R1H3	50Vdc	10000pF+20%-20%	-	10A		Kit	≥10A				Flow	RefFlow
		NFM31KC103R2A3		100Vdc	10000pF+20%-20%	-	10A		Kit	≥10A				Flow	RefFlow	
NFM31KC153R1H3		50Vdc		15000pF+20%-20%	-	10A		Kit	≥10A				Flow	RefFlow		
NFM31KC153R2A3		100Vdc		15000pF+20%-20%	-	10A		New	Kit	≥10A			Flow	RefFlow		
NFM31KC223R1H3		50Vdc		22000pF+20%-20%	-	10A		Kit	≥10A				Flow	RefFlow		
NFM31KC223R2A3		100Vdc		22000pF+20%-20%	-	10A		New	Kit	≥10A			Flow	RefFlow		
NFM31KC104R1H3		50Vdc		100000pF+20%-20%	-	6A			Kit	≥3A			Flow	RefFlow		
NFM31KC104R2A3		100Vdc		100000pF+20%-20%	-	6A		New	Kit	≥3A			Flow	RefFlow		
1806		p126	NFM41PC204F1H3	50Vdc	0.2μF+80%-20%	-	2A		Kit	≥1A				Flow	RefFlow	
	NFM41PC155B1E3	25Vdc	1.5μF+20%-20%	-	6A		Kit	≥3A				Flow	RefFlow			
LC Combined Type for Power Lines and Signal Lines	1206	p116	NFE31PT220R1E9	25Vdc	22pF+30%-30%	-	6A			≥3A				RefFlow		
			NFE31PT470C1E9	25Vdc	47pF+50%-20%	-	6A			≥3A				RefFlow		
			NFE31PT101C1E9	25Vdc	100pF+80%-20%	-	6A			≥3A				RefFlow		
			NFE31PT221D1E9	25Vdc	220pF+50%-20%	-	6A			≥3A				RefFlow		
			NFE31PT471F1E9	25Vdc	470pF+50%-20%	-	6A			≥3A				RefFlow		
			NFE31PT152Z1E9	25Vdc	1500pF+50%-20%	-	6A		Kit	≥3A				RefFlow		
	2706	p117	NFE61PT330B1H9	50Vdc	33pF+30%-30%	-	2A			≥1A			Flow	RefFlow		
			NFE61PT680B1H9	50Vdc	68pF+30%-30%	-	2A			≥1A			Flow	RefFlow		
			NFE61PT101Z1H9	50Vdc	100pF+30%-30%	-	2A			≥1A			Flow	RefFlow		
			NFE61PT181B1H9	50Vdc	180pF+30%-30%	-	2A			≥1A			Flow	RefFlow		
			NFE61PT361B1H9	50Vdc	360pF+20%-20%	-	2A			≥1A			Flow	RefFlow		
			NFE61PT681B1H9	50Vdc	680pF+30%-30%	-	2A			≥1A			Flow	RefFlow		
		p118	NFE61PT102E1H9	50Vdc	1000pF+80%-20%	-	2A		Kit	≥1A			Flow	RefFlow		
			NFE61PT472C1H9	50Vdc	4700pF+80%-20%	-	2A			≥1A			Flow	RefFlow		
			0402	p132	NFL15ST157X0J3	6.3Vdc	22pF (Typ.)	150MHz	50mA		Kit			DTV		RefFlow
					NFL15ST207X0J3	6.3Vdc	17pF (Typ.)	200MHz	50mA		Kit			DTV		RefFlow
					NFL15ST307X0J3	6.3Vdc	12pF (Typ.)	300MHz	50mA		Kit					RefFlow
					NFL15ST507X0J3	6.3Vdc	7pF (Typ.)	500MHz	50mA		Kit					RefFlow
0603	p133	NFL18ST506H1A3	10Vdc	110pF (Typ.)	50MHz	75mA		Kit			DTV		RefFlow			
		NFL18ST706H1A3	10Vdc	70pF (Typ.)	70MHz	75mA		Kit			DTV		RefFlow			
		NFL18ST107H1A3	10Vdc	50pF (Typ.)	100MHz	75mA		Kit			DTV		RefFlow			
		NFL18ST207H1A3	10Vdc	22pF (Typ.)	200MHz	100mA		Kit			DTV		RefFlow			
		NFL18ST307H1A3	10Vdc	16pF (Typ.)	300MHz	100mA		Kit					RefFlow			
		NFL18ST507H1A3	10Vdc	10pF (Typ.)	500MHz	100mA		Kit					RefFlow			
	p134	NFL18ST207X1C3	16Vdc	25pF+20%-20%	200MHz	150mA		Kit					RefFlow			
		NFL18ST307X1C3	16Vdc	18pF+20%-20%	300MHz	200mA		Kit					RefFlow			
		NFL18ST507X1C3	16Vdc	10pF+20%-20%	500MHz	200mA		Kit					RefFlow			
		p135	NFL18SP157X1A3	10Vdc	34pF+20%-20%	150MHz	100mA		Kit					RefFlow		
NFL18SP207X1A3	10Vdc		24pF+20%-20%	200MHz	100mA		Kit					RefFlow				
NFL18SP307X1A3	10Vdc		19pF+20%-20%	300MHz	100mA		Kit					RefFlow				
NFL18SP507X1A3	10Vdc		11pF+20%-20%	500MHz	100mA		Kit					RefFlow				

Continued on the following page.

△Note • Please read rating and △CAUTION (for storage, operating, rating, soldering, mounting and handling) in this catalog to prevent smoking and/or burning, etc.
• This catalog has only typical specifications. Therefore, please approve our product specifications or transact the approval sheet for product specifications before ordering.

Type	Size Code (Inch)	Thickness (mm)	Part Number	Rated Voltage	Capacitance	Nominal Cut-off Frequency	Rated Current	New	Kit	$\geq 1A$	$\geq 3A$	$\geq 10A$	DTV	Flow	RefFlow			
LC Combined Multilayer Type for Signal Lines	p136	0805	0.85 NFL21SP106X1C3	16Vdc	670pF+20%-20%	10MHz	100mA		Kit							RefFlow		
			0.85 NFL21SP206X1C7	16Vdc	240pF+20%-20%	20MHz	100mA		Kit								RefFlow	
			0.85 NFL21SP506X1C3	16Vdc	84pF+20%-20%	50MHz	150mA		Kit								RefFlow	
			0.85 NFL21SP706X1C3	16Vdc	76pF+20%-20%	70MHz	150mA		Kit								RefFlow	
			0.85 NFL21SP107X1C3	16Vdc	44pF+20%-20%	100MHz	200mA		Kit								RefFlow	
			0.85 NFL21SP157X1C3	16Vdc	28pF+20%-20%	150MHz	200mA		Kit								RefFlow	
			0.85 NFL21SP207X1C3	16Vdc	22pF+20%-20%	200MHz	250mA		Kit								RefFlow	
			0.85 NFL21SP307X1C3	16Vdc	19pF+10%-10%	300MHz	300mA		Kit								RefFlow	
			0.85 NFL21SP407X1C3	16Vdc	16pF+10%-10%	400MHz	300mA		Kit						RefFlow			
			0.85 NFL21SP507X1C3	16Vdc	12pF+10%-10%	500MHz	300mA		Kit						RefFlow			
LC Combined Array Type for Signal Lines	p137	0603	0.6 NFA18SL137V1A45	10Vdc	-	130MHz	50mA		Kit				DTV		RefFlow			
			0.6 NFA18SL187V1A45	10Vdc	-	180MHz	50mA		Kit				DTV		RefFlow			
			0.6 NFA18SL207V1A45	10Vdc	-	200MHz	50mA		Kit				DTV		RefFlow			
			0.6 NFA18SL227V1A45	10Vdc	-	220MHz	25mA		Kit				DTV		RefFlow			
			0.5 NFA18SL307V1A45	10Vdc	-	300MHz	100mA		Kit							RefFlow		
			0.5 NFA18SL357V1A45	10Vdc	-	350MHz	35mA		Kit							RefFlow		
			0.5 NFA18SL407V1A45	10Vdc	-	400MHz	100mA		Kit							RefFlow		
			0.5 NFA18SL487V1A45	10Vdc	-	480MHz	100mA		Kit							RefFlow		
	p138			0.6 NFA18SL506X1A45	10Vdc	-	50MHz	25mA		Kit					RefFlow			
	p139			0.6 NFA18SD187X1A45	10Vdc	-	180MHz	25mA		Kit				DTV		RefFlow		
				0.6 NFA18SD207X1A45	10Vdc	-	200MHz	25mA		Kit				DTV		RefFlow		
	p140	0805	0.5 NFA21SL287V1A45	10Vdc	-	280MHz	100mA		Kit							RefFlow		
			0.5 NFA21SL317V1A45	10Vdc	-	310MHz	100mA		Kit							RefFlow		
			0.5 NFA21SL337V1A45	10Vdc	-	330MHz	100mA		Kit							RefFlow		
			0.85 NFA21SL287V1A48	10Vdc	-	280MHz	100mA		Kit								RefFlow	
			0.85 NFA21SL317V1A48	10Vdc	-	310MHz	100mA		Kit								RefFlow	
			0.85 NFA21SL337V1A48	10Vdc	-	330MHz	100mA		Kit								RefFlow	
			p141	0.5 NFA21SL207X1A45	10Vdc	-	200MHz	100mA		Kit								RefFlow
				0.5 NFA21SL307X1A45	10Vdc	-	300MHz	100mA		Kit								RefFlow
				0.85 NFA21SL506X1A48	10Vdc	-	50MHz	20mA		Kit								RefFlow
0.85 NFA21SL806X1A48				10Vdc	-	80MHz	20mA		Kit								RefFlow	
0.85 NFA21SL207X1A48				10Vdc	-	200MHz	100mA		Kit								RefFlow	
0.85 NFA21SL307X1A48				10Vdc	-	300MHz	100mA		Kit								RefFlow	
LC Combined Wire Wound Type for Signal Lines	p142	1206		1.8 NFW31SP106X1E4	-	-	10MHz	-		Kit					Flow	RefFlow		
				1.8 NFW31SP206X1E4	-	-	20MHz	-		Kit					Flow	RefFlow		
			1.8 NFW31SP506X1E4	-	-	50MHz	-		Kit					Flow	RefFlow			
			1.8 NFW31SP107X1E4	-	-	100MHz	-		Kit					Flow	RefFlow			
			1.8 NFW31SP157X1E4	-	-	150MHz	-		Kit					Flow	RefFlow			
			1.8 NFW31SP207X1E4	-	-	200MHz	-		Kit					Flow	RefFlow			
			1.8 NFW31SP307X1E4	-	-	300MHz	-		Kit					Flow	RefFlow			
			1.8 NFW31SP407X1E4	-	-	400MHz	-		Kit					Flow	RefFlow			
1.8 NFW31SP507X1E4	-	-	500MHz	-		Kit					Flow	RefFlow						
RC Combined Type for Signal Lines	p144	0805	0.5 NFR21GD1002202	50Vdc	10pF+20%-20%	-	50mA								RefFlow			
			0.5 NFR21GD1004702	50Vdc	10pF+20%-20%	-	35mA								RefFlow			
			0.5 NFR21GD4702202	50Vdc	47pF+20%-20%	-	50mA								RefFlow			
			0.5 NFR21GD4704702	50Vdc	47pF+20%-20%	-	35mA									RefFlow		
			0.5 NFR21GD4706802	50Vdc	47pF+20%-20%	-	30mA									RefFlow		
			0.5 NFR21GD4701012	50Vdc	47pF+20%-20%	-	25mA									RefFlow		
			0.5 NFR21GD1012202	50Vdc	100pF+20%-20%	-	50mA									RefFlow		
			0.5 NFR21GD1014702	50Vdc	100pF+20%-20%	-	35mA									RefFlow		
			0.5 NFR21GD1016802	50Vdc	100pF+20%-20%	-	30mA									RefFlow		
0.5 NFR21GD1011012	50Vdc	100pF+20%-20%	-	25mA									RefFlow					
RC Combined Array Type for Signal Lines	p145	1206	0.8 NFA31GD1006R84	6Vdc	10pF+20%-20%	-	50mA								RefFlow			
			0.8 NFA31GD1004704	6Vdc	10pF+20%-20%	-	20mA								RefFlow			
			0.8 NFA31GD1001014	6Vdc	10pF+20%-20%	-	15mA								RefFlow			
			0.8 NFA31GD4706R84	6Vdc	47pF+20%-20%	-	50mA									RefFlow		
			0.8 NFA31GD4703304	6Vdc	47pF+20%-20%	-	20mA									RefFlow		
			0.8 NFA31GD4704704	6Vdc	47pF+20%-20%	-	20mA									RefFlow		
			0.8 NFA31GD4701014	6Vdc	47pF+20%-20%	-	15mA									RefFlow		
			0.8 NFA31GD1016R84	6Vdc	100pF+20%-20%	-	50mA									RefFlow		
			0.8 NFA31GD1014704	6Vdc	100pF+20%-20%	-	20mA									RefFlow		
0.8 NFA31GD1011014	6Vdc	100pF+20%-20%	-	15mA									RefFlow					

△Note • Please read rating and △CAUTION (for storage, operating, rating, soldering, mounting and handling) in this catalog to prevent smoking and/or burning, etc.
 • This catalog has only typical specifications. Therefore, please approve our product specifications or transact the approval sheet for product specifications before ordering.

Chip Ferrite Bead

Chip EMIFIL®

Chip Common Mode Choke Coil

Block Type EMIFIL®

Microwave Absorber

NFE31P Series (1206 Size)



Meets 6A, T-type filter with built-in ferrite bead.



Dimensions

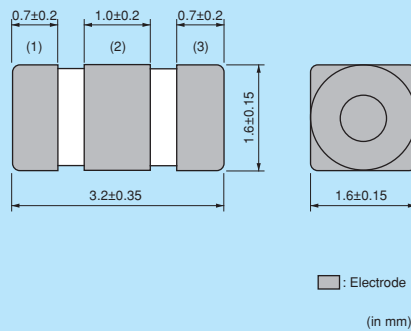

Equivalent Circuit

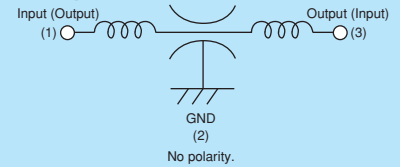

Packaging

Code	Packaging	Minimum Quantity
L	180mm Reel Embossed Tape	2000
K	330mm Reel Embossed Tape	8000
B	Bulk(Bag)	500

Refer to pages from p.147 to p.152 for mounting information.

Rated Value (□: packaging code)

Part Number	Capacitance	Rated Current	Rated Voltage	Insulation Resistance (min.)	Operating Temperature Range	
NFE31PT220R1E9□	22pF ±30%	6A	25Vdc	1000M ohm	-40°C to +85°C	≥3A
NFE31PT470C1E9□	47pF 50/-20%	6A	25Vdc	1000M ohm	-40°C to +85°C	≥3A
NFE31PT101C1E9□	100pF 80/-20%	6A	25Vdc	1000M ohm	-40°C to +85°C	≥3A
NFE31PT221D1E9□	220pF 50/-20%	6A	25Vdc	1000M ohm	-40°C to +85°C	≥3A
NFE31PT471F1E9□	470pF 50/-20%	6A	25Vdc	1000M ohm	-40°C to +85°C	≥3A
NFE31PT152Z1E9□	1500pF 50/-20%	6A	25Vdc	1000M ohm	-40°C to +85°C	Kit ≥3A
NFE31PT222Z1E9□	2200pF ±50%	6A	25Vdc	1000M ohm	-40°C to +85°C	≥3A

Number of Circuit: 1

Insertion Loss Characteristics

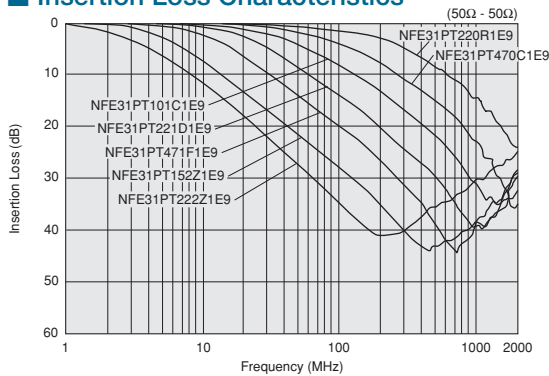

△Note • Please read rating and △CAUTION (for storage, operating, rating, soldering, mounting and handling) in this catalog to prevent smoking and/or burning, etc.
 • This catalog has only typical specifications. Therefore, please approve our product specifications or transact the approval sheet for product specifications before ordering.

Chip Ferrite Bead
 Chip EMIFIL® Universal Type [Power Lines/Signal Lines]
 Chip Common Mode Choke Coil
 Block Type EMIFIL®
 Microwave Absorber

NFE61P Series (2706 Size)



T-type filter with built-in ferrite bead.



■ Dimensions

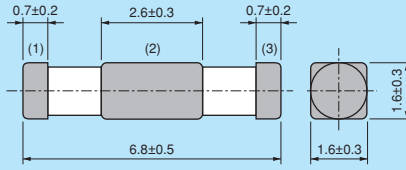

□ : Electrode
(in mm)

■ Equivalent Circuit

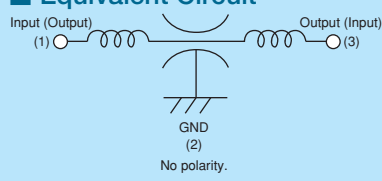

■ Packaging

Code	Packaging	Minimum Quantity
L	180mm Reel Embossed Tape	2500
K	330mm Reel Embossed Tape	8000
B	Bulk(Bag)	500

Refer to pages from p.147 to p.152 for mounting information.

■ Rated Value (□: packaging code)

Part Number	Capacitance	Rated Current	Rated Voltage	Insulation Resistance (min.)	Operating Temperature Range	
NFE61PT330B1H9□	33pF ±30%	2A	50Vdc	1000M ohm	-40°C to +85°C	≥1A
NFE61PT680B1H9□	68pF ±30%	2A	50Vdc	1000M ohm	-40°C to +85°C	≥1A
NFE61PT101Z1H9□	100pF ±30%	2A	50Vdc	1000M ohm	-40°C to +85°C	≥1A
NFE61PT181B1H9□	180pF ±30%	2A	50Vdc	1000M ohm	-40°C to +85°C	≥1A
NFE61PT361B1H9□	360pF ±20%	2A	50Vdc	1000M ohm	-40°C to +85°C	≥1A
NFE61PT681B1H9□	680pF ±30%	2A	50Vdc	1000M ohm	-40°C to +85°C	≥1A
NFE61PT102E1H9□	1000pF 80/-20%	2A	50Vdc	1000M ohm	-40°C to +85°C	Kit ≥1A
NFE61PT472C1H9□	4700pF 80/-20%	2A	50Vdc	1000M ohm	-40°C to +85°C	≥1A

Number of Circuit: 1

■ Insertion Loss Characteristics

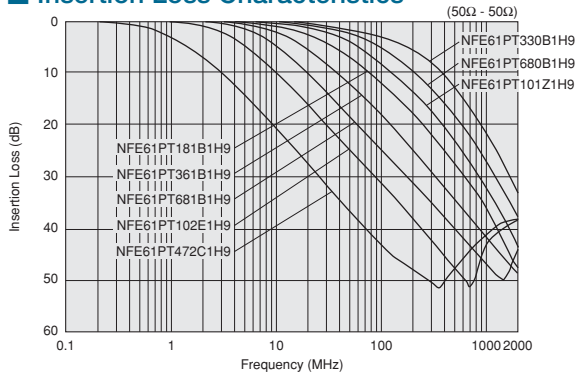

△Note • Please read rating and △CAUTION (for storage, operating, rating, soldering, mounting and handling) in this catalog to prevent smoking and/or burning, etc.
• This catalog has only typical specifications. Therefore, please approve our product specifications or transact the approval sheet for product specifications before ordering.

Chip Ferrite Bead

Universal Type [Power Lines/Signal Lines] Chip EMIFIL®

Chip Common Mode Choke Coil

Block Type EMIFIL®

Microwave Absorber

NFM18PS Series (0603 Size)



3-terminal capacitor for power lines whose ground impedance has reduced.

*Please refer to the products designed for both power lines and signal lines.



■ Dimensions

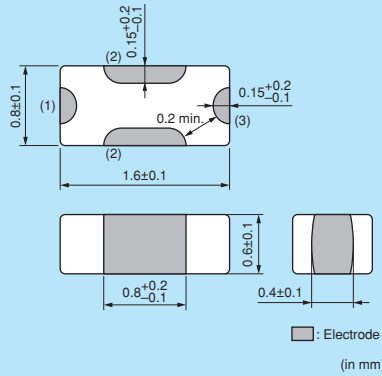

■ Equivalent Circuit

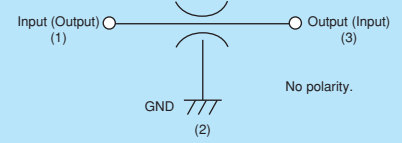

■ Packaging

Code	Packaging	Minimum Quantity
D	180mm Reel Paper Tape	4000
B	Bulk(Bag)	500

Refer to pages from p.147 to p.152 for mounting information.

■ Rated Value (□: packaging code)

Part Number	Capacitance	Rated Current	Rated Voltage	Insulation Resistance (min.)	Operating Temperature Range	
NFM18PS474R0J3□	0.47μF ±20%	2A	6.3Vdc	1000M ohm	-55°C to +125°C	Kit ≥1A
NFM18PS105R0J3□	1.0μF ±20%	2A	6.3Vdc	500M ohm	-55°C to +105°C	Kit ≥1A

Number of Circuit: 1

■ Insertion Loss Characteristics

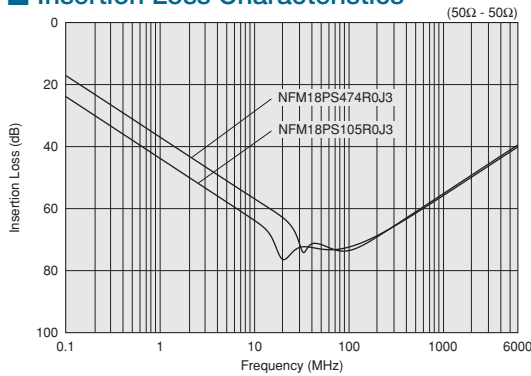

△Note • Please read rating and △CAUTION (for storage, operating, rating, soldering, mounting and handling) in this catalog to prevent smoking and/or burning, etc.
 • This catalog has only typical specifications. Therefore, please approve our product specifications or transact the approval sheet for product specifications before ordering.

Chip Ferrite Bead
Chip EMIFIL® Power Lines Type
Chip Common Mode Choke Coil
Block Type EMIFIL®
Microwave Absorber

NFM18PC Series (0603 Size)



4A max, 0603 size chip 3-terminal capacitor for power lines.

*Please refer to the products designed for both power lines and signal lines.

NFM18PC (0.1 to 0.47μF, 2.2μF - 6.3V)

■ Dimensions

■ : Electrode
(in mm)

■ Equivalent Circuit

No polarity.

■ Packaging

Code	Packaging	Minimum Quantity
D	180mm Reel Paper Tape	4000
B	Bulk(Bag)	500

NFM18PC (1μF, 2.2μF - 10V)

■ Dimensions

■ : Electrode
(in mm)

■ Equivalent Circuit

No polarity.

■ Packaging

Code	Packaging	Minimum Quantity
D	180mm Reel Paper Tape	4000
B	Bulk(Bag)	500

Refer to pages from p.147 to p.152 for mounting information.

■ Rated Value (□: packaging code)

Part Number	Capacitance	Rated Current	Rated Voltage	Insulation Resistance (min.)	Operating Temperature Range	
NFM18PC104R1C3□	0.1μF ±20%	2A	16Vdc	1000M ohm	-55°C to +125°C	Kit ≥1A
NFM18PC224R0J3□	0.22μF ±20%	2A	6.3Vdc	1000M ohm	-55°C to +125°C	Kit ≥1A
NFM18PC474R0J3□	0.47μF ±20%	2A	6.3Vdc	1000M ohm	-55°C to +125°C	Kit ≥1A
NFM18PC105R0J3□	1.0μF ±20%	4A	6.3Vdc	500M ohm	-55°C to +105°C	Kit ≥1A
NFM18PC225B0J3□	2.2μF ±20%	2A	6.3Vdc	200M ohm	-40°C to +85°C	Kit ≥1A
NFM18PC225B1A3□	2.2μF ±20%	4A	10Vdc	200M ohm	-40°C to +85°C	Kit ≥3A

Number of Circuit: 1

■ Insertion Loss Characteristics

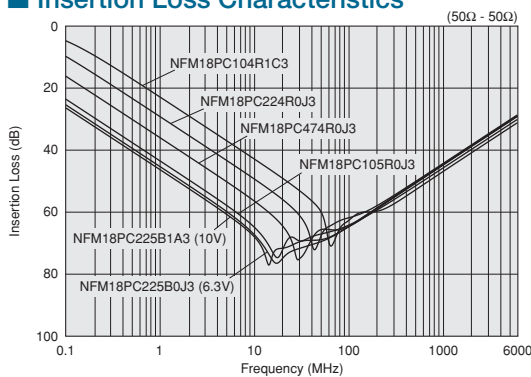

△Note • Please read rating and △CAUTION (for storage, operating, rating, soldering, mounting and handling) in this catalog to prevent smoking and/or burning, etc.
• This catalog has only typical specifications. Therefore, please approve our product specifications or transact the approval sheet for product specifications before ordering.

Chip Ferrite Bead

Power Lines Type
Chip EMIFIL®

Chip Common Mode Choke Coil

Block Type EMIFIL®

Microwave Absorber

• High frequency performance of NFM18PS series

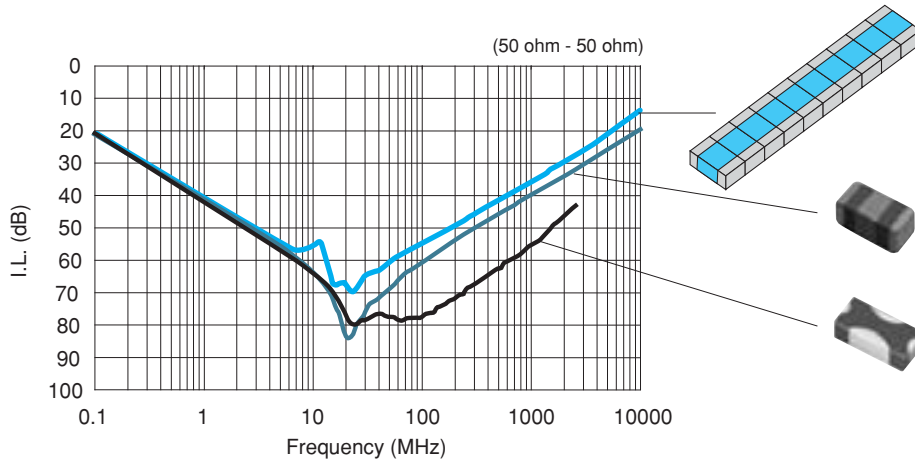

Chip 3-terminal capacitor

2 terminal MLCC: 2012mm size
(0.1μFx10pcs parallel)

NFM18PC105R0J3 1pc
: 1608mm size (1.0μFx1)

NFM18PS105R0J3 1pc
: 1608mm size (1.0μFx1)

NFM18PS series has better high-frequency performance compared to normal chip 3 terminal capacitors.

• Optimize of bypass capacitors using chip 3-terminal capacitor

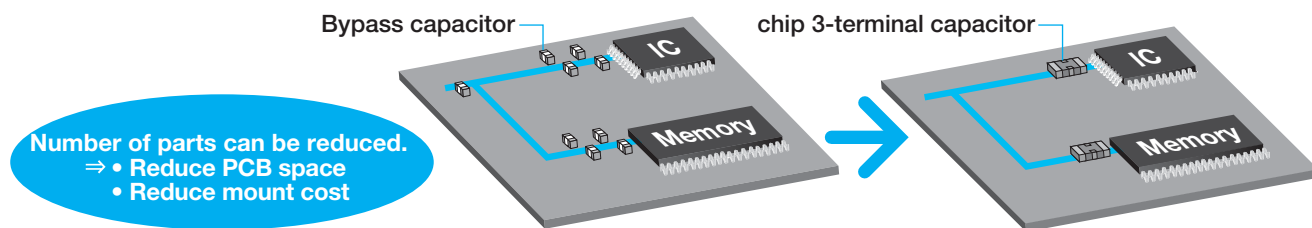

Comparison of performance as a bypass capacitor

Without capacitor

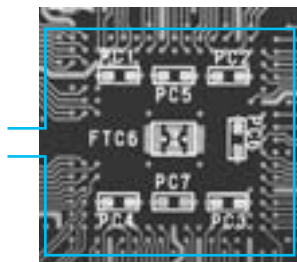

Micro computer

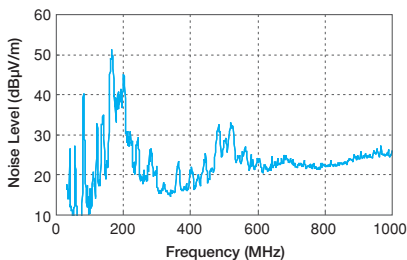
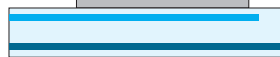

With MLCC 0.22μFx4

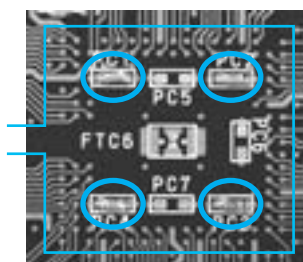

Micro computer

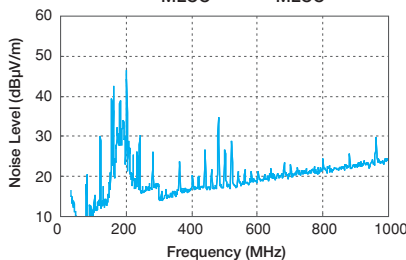
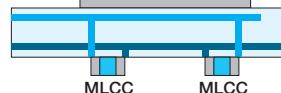

With chip 3-terminal capacitor (NFM) 1μFx1

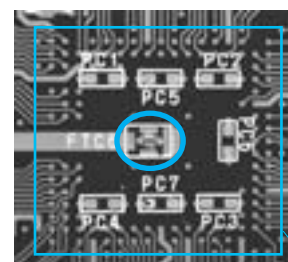

Micro computer

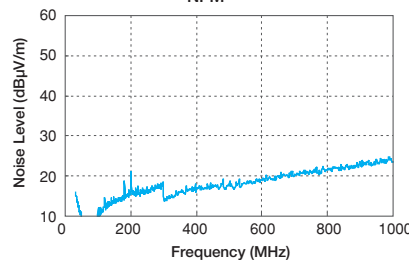

Noise suppression effect of NFM series is better than MLCCs (1 NFM is better than 4 MLCCs).

△Note • Please read rating and △CAUTION (for storage, operating, rating, soldering, mounting and handling) in this catalog to prevent smoking and/or burning, etc.
• This catalog has only typical specifications. Therefore, please approve our product specifications or transact the approval sheet for product specifications before ordering.

NFM21PS Series (0805 Size)



2012mm size 3-terminal capacitor with very low ground impedance.

■ Dimensions

(in mm)

■ Equivalent Circuit

No polarity.

■ Packaging

Code	Packaging	Minimum Quantity
D	180mm Reel Paper Tape	4000
B	Bulk(Bag)	500

Refer to pages from p.147 to p.152 for mounting information.

■ Rated Value (□: packaging code)

Part Number	Capacitance	Rated Current	Rated Voltage	Insulation Resistance (min.)	Operating Temperature Range	
NFM21PS106B0J3□	10μF ±20%	4A	6.3Vdc	50M ohm	-40°C to +85°C	Kit ≥3A

Number of Circuit: 1

■ Insertion Loss Characteristics

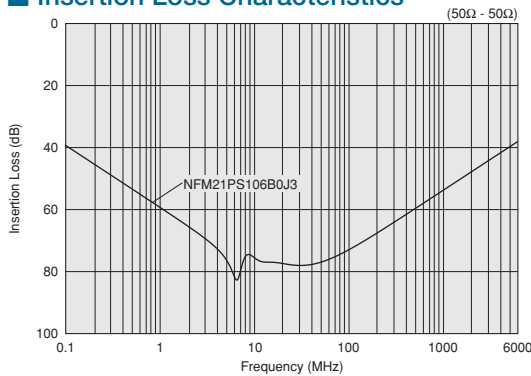

⚠Note • Please read rating and ⚠CAUTION (for storage, operating, rating, soldering, mounting and handling) in this catalog to prevent smoking and/or burning, etc.
 • This catalog has only typical specifications. Therefore, please approve our product specifications or transact the approval sheet for product specifications before ordering.

Chip Ferrite Bead
 Power Lines Type Chip EMIFIL®
 Chip Common Mode Choke Coil
 Block Type EMIFIL®
 Microwave Absorber

NFM21PC Series (0805 Size)



6A max, 0805 size chip 3-terminal capacitor for power lines.

*Please refer to the products designed for both power lines and signal lines.

■ Dimensions

(in mm)

■ Equivalent Circuit

No polarity.

■ Packaging

Code	Packaging	Minimum Quantity
D	180mm Reel Paper Tape	4000
B	Bulk(Bag)	500

Refer to pages from p.147 to p.152 for mounting information.

■ Rated Value (□: packaging code)

Part Number	Capacitance	Rated Current	Rated Voltage	Insulation Resistance (min.)	Operating Temperature Range	
NFM21PC104R1E3□	0.1μF ±20%	2A	25Vdc	1000M ohm	-55°C to +125°C	Kit ≥1A
NFM21PC224R1C3□	0.22μF ±20%	2A	16Vdc	1000M ohm	-55°C to +125°C	Kit ≥1A
NFM21PC474R1C3□	0.47μF ±20%	2A	16Vdc	1000M ohm	-55°C to +125°C	Kit ≥1A
NFM21PC105B1A3□	1.0μF ±20%	4A	10Vdc	500M ohm	-40°C to +85°C	Kit ≥3A
NFM21PC105B1C3□	1.0μF ±20%	4A	16Vdc	500M ohm	-40°C to +85°C	Kit ≥3A
NFM21PC225B0J3□	2.2μF ±20%	4A	6.3Vdc	200M ohm	-40°C to +85°C	Kit ≥3A
NFM21PC475B1A3□	4.7μF ±20%	6A	10Vdc	100M ohm	-40°C to +85°C	Kit ≥3A

Number of Circuit: 1

■ Insertion Loss Characteristics

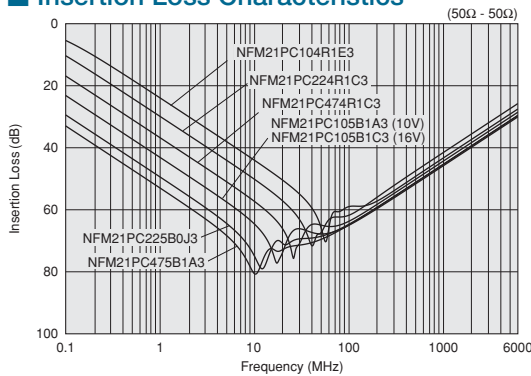

△Note • Please read rating and △CAUTION (for storage, operating, rating, soldering, mounting and handling) in this catalog to prevent smoking and/or burning, etc.
 • This catalog has only typical specifications. Therefore, please approve our product specifications or transact the approval sheet for product specifications before ordering.

Chip Ferrite Bead

Chip EMIFIL®
Power Lines Type

Chip Common Mode Choke Coil

Block Type EMIFIL®

Microwave Absorber

NFM3DP Series (1205 Size)



1205 size 3-terminal capacitor for power lines.

*Please refer to the products designed for both power lines and signal lines.

■ Dimensions

(in mm)

■ Equivalent Circuit

No polarity.

■ Packaging

Code	Packaging	Minimum Quantity
L	180mm Reel Embossed Tape	4000
B	Bulk(Bag)	500

Refer to pages from p.147 to p.152 for mounting information.

■ Rated Value (□: packaging code)

Part Number	Capacitance	Rated Current	Rated Voltage	Insulation Resistance (min.)	Operating Temperature Range	
NFM3DPC223R1H3□	0.022μF ±20%	2A	50Vdc	1000M ohm	-55°C to +125°C	≥1A

Number of Circuit: 1

■ Insertion Loss Characteristics

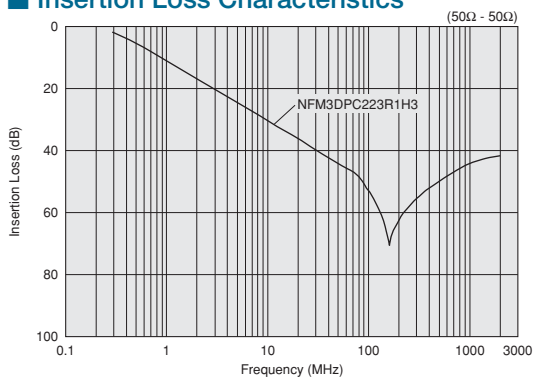

■ Notice (Rating)

When NFM3DP series is used in operating temperature exceeding +85°C, derating of current is necessary. Please apply the derating curve shown in chart according to the operating temperature.

Derating of Rated Current

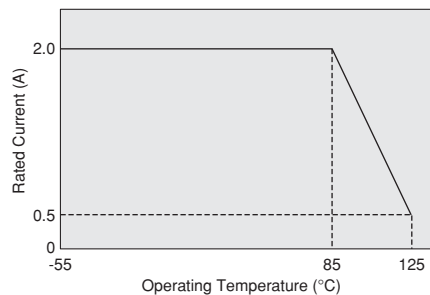

⚠Note • Please read rating and ⚠CAUTION (for storage, operating, rating, soldering, mounting and handling) in this catalog to prevent smoking and/or burning, etc.
 • This catalog has only typical specifications. Therefore, please approve our product specifications or transact the approval sheet for product specifications before ordering.

Chip Ferrite Bead
Power Lines Type Chip EMIFIL®
Chip Common Mode Choke Coil
Block Type EMIFIL®
Microwave Absorber

NFM31P Series (1206 Size)



6A/27microF, 1206 size chip 3-terminal capacitor for power lines.

*Please refer to the products designed for both power lines and signal lines.



■ Dimensions

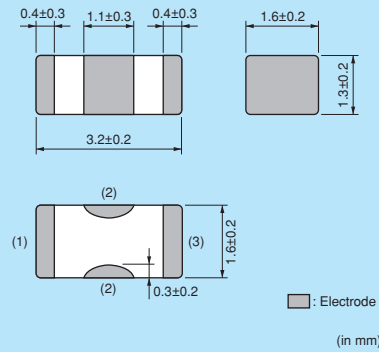

■ Equivalent Circuit

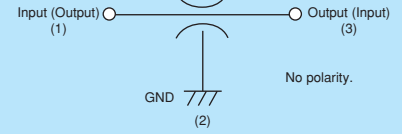

■ Packaging

Code	Packaging	Minimum Quantity
L	180mm Reel Embossed Tape	3000
B	Bulk(Bag)	500

Refer to pages from p.147 to p.152 for mounting information.

■ Rated Value (□: packaging code)

Part Number	Capacitance	Rated Current	Rated Voltage	Insulation Resistance (min.)	Operating Temperature Range	
NFM31PC276B0J3□	27μF ±20%	6A	6.3Vdc	20M ohm	-40°C to +85°C	Kit ≥3A

Number of Circuit: 1

■ Insertion Loss Characteristics

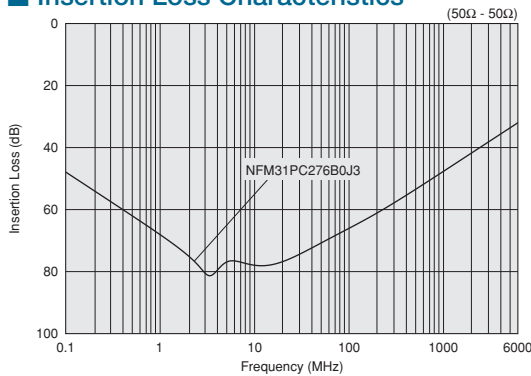

△Note • Please read rating and △CAUTION (for storage, operating, rating, soldering, mounting and handling) in this catalog to prevent smoking and/or burning, etc.
 • This catalog has only typical specifications. Therefore, please approve our product specifications or transact the approval sheet for product specifications before ordering.

Chip Ferrite Bead

Chip EMIFIL®
 Power Lines Type

Chip Common Mode Choke Coil

Block Type EMIFIL®

Microwave Absorber

NFM31K Series (1206 Size)



Capable for 10A max. Large current 3-terminal capacitor.

■ Dimensions

(in mm)

■ Equivalent Circuit

■ Packaging

Code	Packaging	Minimum Quantity
L	180mm Reel Embossed Tape	3000
B	Bulk(Bag)	500

Refer to pages from p.147 to p.152 for mounting information.

■ Rated Value (□: packaging code)

Part Number	Capacitance	Rated Current	Rated Voltage	Insulation Resistance (min.)	Operating Temperature Range	Kit	Current Rating
NFM31KC103R1H3□	10000pF ±20%	10A	50Vdc	1000M ohm	-55°C to +125°C	Kit	≥10A
NFM31KC103R2A3□	10000pF ±20%	10A	100Vdc	1000M ohm	-55°C to +125°C	Kit	≥10A
NFM31KC153R1H3□	15000pF ±20%	10A	50Vdc	1000M ohm	-55°C to +125°C	Kit	≥10A
NFM31KC153R2A3□	15000pF ±20%	10A	100Vdc	1000M ohm	-55°C to +105°C	New Kit	≥10A
NFM31KC223R1H3□	22000pF ±20%	10A	50Vdc	1000M ohm	-55°C to +125°C	Kit	≥10A
NFM31KC223R2A3□	22000pF ±20%	10A	100Vdc	1000M ohm	-55°C to +105°C	New Kit	≥10A
NFM31KC104R1H3□	100000pF ±20%	6A	50Vdc	1000M ohm	-55°C to +125°C		≥3A
NFM31KC104R2A3□	100000pF ±20%	6A	100Vdc	1000M ohm	-55°C to +105°C	New Kit	≥3A

Number of Circuit: 1

■ Insertion Loss Characteristics

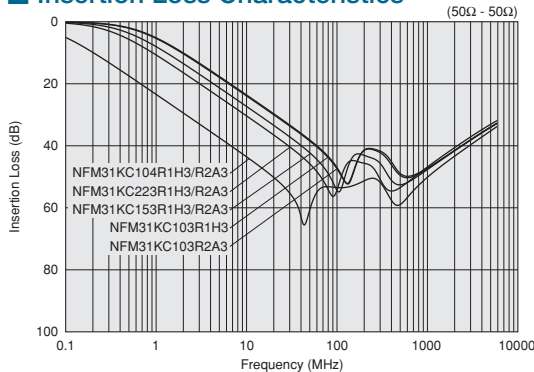

■ Notice (Rating)

When NFM31K series is used in operating temperatures exceeding +105°C, derating of current is necessary. Please apply the derating curve shown in chart according to the operating temperature.

Derating of Rated Current

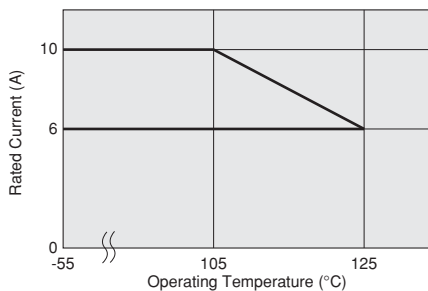

△Note • Please read rating and △CAUTION (for storage, operating, rating, soldering, mounting and handling) in this catalog to prevent smoking and/or burning, etc.
 • This catalog has only typical specifications. Therefore, please approve our product specifications or transact the approval sheet for product specifications before ordering.

Chip Ferrite Bead

Power Lines Type
Chip EMIFIL®

Chip Common Mode Choke Coil

Block Type EMIFIL®

Microwave Absorber

NFM41P Series (1806 Size)



6A max, 1806 size chip 3-terminal capacitor for power lines.

*Please refer to the products designed for both power lines and signal lines.



Dimensions

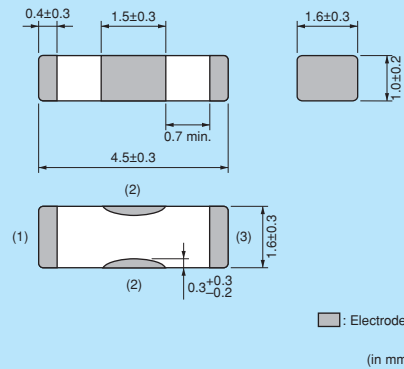

Equivalent Circuit

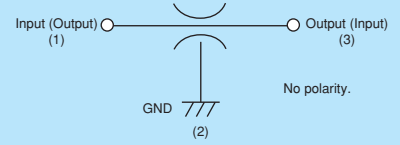

Packaging

Code	Packaging	Minimum Quantity
L	180mm Reel Embossed Tape	4000
B	Bulk(Bag)	500

Refer to pages from p.147 to p.152 for mounting information.

Rated Value (□: packaging code)

Part Number	Capacitance	Rated Current	Rated Voltage	Insulation Resistance (min.)	Operating Temperature Range	
NFM41PC204F1H3□	0.2μF +80/-20%	2A	50Vdc	1000M ohm	-55°C to +85°C	Kit ≥1A
NFM41PC155B1E3□	1.5μF ±20%	6A	25Vdc	300M ohm	-55°C to +85°C	Kit ≥3A

Number of Circuit: 1

Insertion Loss Characteristics

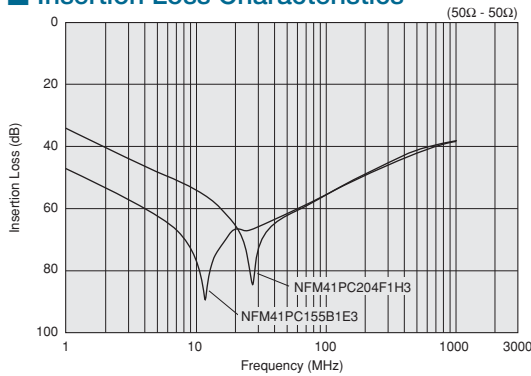

△Note • Please read rating and △CAUTION (for storage, operating, rating, soldering, mounting and handling) in this catalog to prevent smoking and/or burning, etc.
 • This catalog has only typical specifications. Therefore, please approve our product specifications or transact the approval sheet for product specifications before ordering.

Chip Ferrite Bead
 Chip EMIFIL® Power Lines Type
 Chip Common Mode Choke Coil
 Block Type EMIFIL®
 Microwave Absorber

NFM18C Series (0603 Size)



0603 size general 3-terminal capacitor.

■ Dimensions

(in mm)

■ Equivalent Circuit

■ Packaging

Code	Packaging	Minimum Quantity
D	180mm Reel Paper Tape	4000
B	Bulk(Bag)	500

Refer to pages from p.147 to p.152 for mounting information.

■ Rated Value (□: packaging code)

Part Number	Capacitance	Rated Current	Rated Voltage	Insulation Resistance (min.)	Operating Temperature Range	
NFM18CC220U1C3□	22pF ±20%	400mA	16Vdc	1000M ohm	-55°C to +125°C	Kit
NFM18CC470U1C3□	47pF ±20%	400mA	16Vdc	1000M ohm	-55°C to +125°C	Kit
NFM18CC101R1C3□	100pF ±20%	500mA	16Vdc	1000M ohm	-55°C to +125°C	Kit
NFM18CC221R1C3□	220pF ±20%	500mA	16Vdc	1000M ohm	-55°C to +125°C	Kit
NFM18CC471R1C3□	470pF ±20%	500mA	16Vdc	1000M ohm	-55°C to +125°C	Kit
NFM18CC102R1C3□	1000pF ±20%	600mA	16Vdc	1000M ohm	-55°C to +125°C	Kit
NFM18CC222R1C3□	2200pF ±20%	700mA	16Vdc	1000M ohm	-55°C to +125°C	Kit
NFM18CC223R1C3□	22000pF ±20%	1000mA	16Vdc	1000M ohm	-55°C to +125°C	Kit ≥1A

Number of Circuit: 1

■ Insertion Loss Characteristics

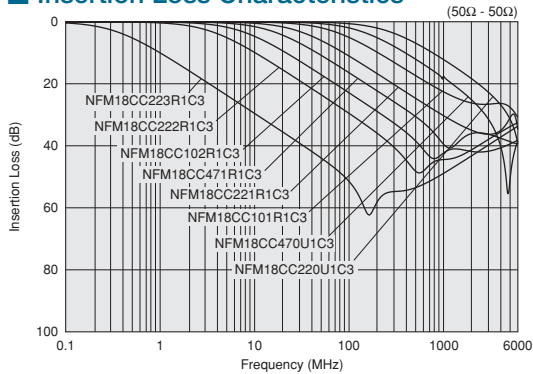

⚠Note • Please read rating and ⚠CAUTION (for storage, operating, rating, soldering, mounting and handling) in this catalog to prevent smoking and/or burning, etc.
 • This catalog has only typical specifications. Therefore, please approve our product specifications or transact the approval sheet for product specifications before ordering.

Chip Ferrite Bead

Signal Lines Type
Chip EMIFIL®

Chip Common Mode Choke Coil

Block Type EMIFIL®

Microwave Absorber

NFM21C Series (0805 Size)



0805 size general 3-terminal capacitor.



Dimensions

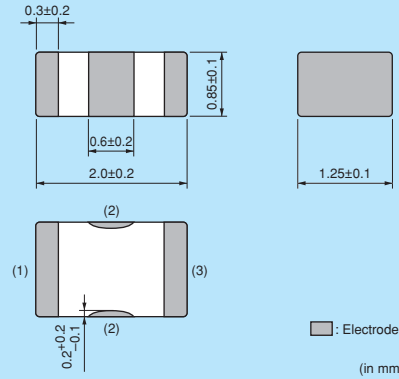

Equivalent Circuit

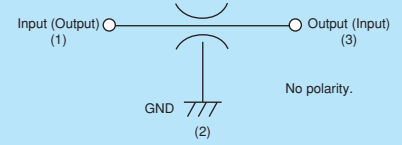

No polarity.

Packaging

Code	Packaging	Minimum Quantity
D	180mm Reel Paper Tape	4000
B	Bulk (Bag)	500

Refer to pages from p.147 to p.152 for mounting information.

Rated Value (□: packaging code)

Part Number	Capacitance	Rated Current	Rated Voltage	Insulation Resistance (min.)	Operating Temperature Range	
NFM21CC220U1H3□	22pF ±20%	700mA	50Vdc	1000M ohm	-55°C to +125°C	Kit
NFM21CC470U1H3□	47pF ±20%	700mA	50Vdc	1000M ohm	-55°C to +125°C	Kit
NFM21CC101U1H3□	100pF ±20%	700mA	50Vdc	1000M ohm	-55°C to +125°C	Kit
NFM21CC221R1H3□	220pF ±20%	700mA	50Vdc	1000M ohm	-55°C to +125°C	Kit
NFM21CC471R1H3□	470pF ±20%	1000mA	50Vdc	1000M ohm	-55°C to +125°C	Kit ≥1A
NFM21CC102R1H3□	1000pF ±20%	1000mA	50Vdc	1000M ohm	-55°C to +125°C	Kit ≥1A
NFM21CC222R1H3□	2200pF ±20%	1000mA	50Vdc	1000M ohm	-55°C to +125°C	Kit ≥1A
NFM21CC223R1H3□	22000pF ±20%	2000mA	50Vdc	1000M ohm	-55°C to +125°C	Kit ≥1A

Number of Circuit: 1

Insertion Loss Characteristics

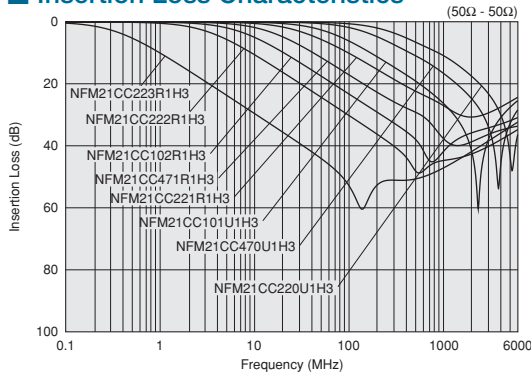

△Note • Please read rating and △CAUTION (for storage, operating, rating, soldering, mounting and handling) in this catalog to prevent smoking and/or burning, etc.
 • This catalog has only typical specifications. Therefore, please approve our product specifications or transact the approval sheet for product specifications before ordering.

Chip Ferrite Bead
Chip EMIFIL® Signal Lines Type
Chip Common Mode Choke Coil
Block Type EMIFIL®
Microwave Absorber

NFM3DC Series (1205 Size)



1205 size general 3-terminal capacitor.



■ Dimensions

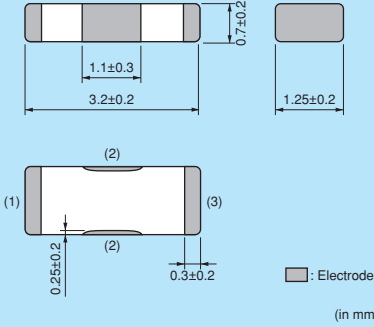

(in mm)

■ Equivalent Circuit

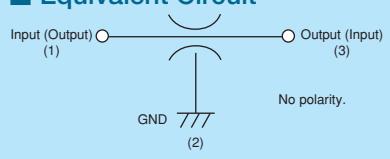

No polarity.

■ Packaging

Code	Packaging	Minimum Quantity
L	180mm Reel Embossed Tape	4000
B	Bulk(Bag)	500

Refer to pages from p.147 to p.152 for mounting information.

■ Rated Value (□: packaging code)

Part Number	Capacitance	Rated Current	Rated Voltage	Insulation Resistance (min.)	Operating Temperature Range
NFM3DCC220U1H3□	22pF +50/-20%	300mA	50Vdc	1000M ohm	-55°C to +125°C
NFM3DCC470U1H3□	47pF +50/-20%	300mA	50Vdc	1000M ohm	-55°C to +125°C
NFM3DCC101U1H3□	100pF +50/-20%	300mA	50Vdc	1000M ohm	-55°C to +125°C
NFM3DCC221R1H3□	220pF +50/-20%	300mA	50Vdc	1000M ohm	-55°C to +125°C
NFM3DCC471R1H3□	470pF +50/-20%	300mA	50Vdc	1000M ohm	-55°C to +125°C
NFM3DCC102R1H3□	1000pF +50/-20%	300mA	50Vdc	1000M ohm	-55°C to +125°C
NFM3DCC222R1H3□	2200pF +50/-20%	300mA	50Vdc	1000M ohm	-55°C to +125°C
NFM3DCC223R1H3□	22000pF +50/-20%	300mA	50Vdc	1000M ohm	-55°C to +125°C

Number of Circuit: 1

■ Insertion Loss Characteristics

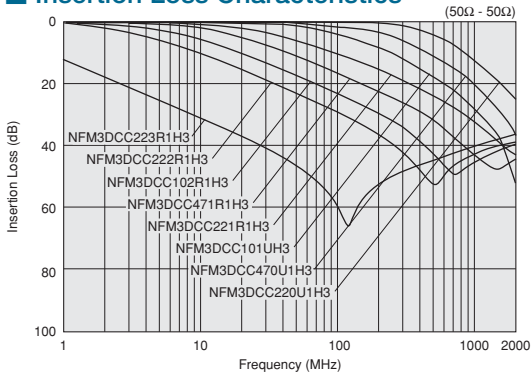

⚠Note • Please read rating and ⚠CAUTION (for storage, operating, rating, soldering, mounting and handling) in this catalog to prevent smoking and/or burning, etc.
 • This catalog has only typical specifications. Therefore, please approve our product specifications or transact the approval sheet for product specifications before ordering.

NFM41C Series (1806 Size)



1806 size general 3-terminal capacitor.



■ Dimensions

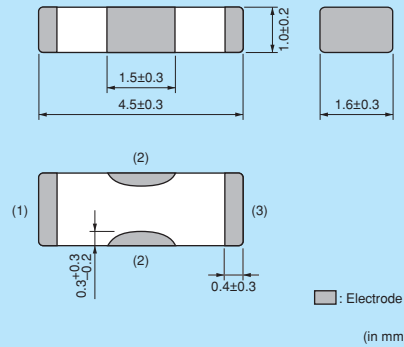

■ Equivalent Circuit

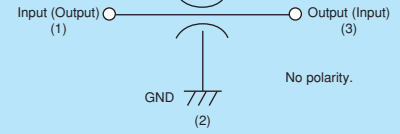

■ Packaging

Code	Packaging	Minimum Quantity
L	180mm Reel Embossed Tape	4000
B	Bulk(Bag)	500

Refer to pages from p.147 to p.152 for mounting information.

■ Rated Value (□: packaging code)

Part Number	Capacitance	Rated Current	Rated Voltage	Insulation Resistance (min.)	Operating Temperature Range
NFM41CC220U2A3□	22pF +50/-20%	300mA	100Vdc	10000M ohm	-55°C to +125°C
NFM41CC470U2A3□	47pF +50/-20%	300mA	100Vdc	10000M ohm	-55°C to +125°C
NFM41CC101U2A3□	100pF +50/-20%	300mA	100Vdc	10000M ohm	-55°C to +125°C
NFM41CC221U2A3□	220pF +50/-20%	300mA	100Vdc	10000M ohm	-55°C to +125°C
NFM41CC471R2A3□	470pF +50/-20%	300mA	100Vdc	10000M ohm	-55°C to +125°C
NFM41CC102R2A3□	1000pF +50/-20%	300mA	100Vdc	10000M ohm	-55°C to +125°C
NFM41CC222R2A3□	2200pF +50/-20%	300mA	100Vdc	10000M ohm	-55°C to +125°C
NFM41CC223R2A3□	22000pF +50/-20%	300mA	100Vdc	10000M ohm	-55°C to +125°C

Number of Circuit: 1

■ Insertion Loss Characteristics

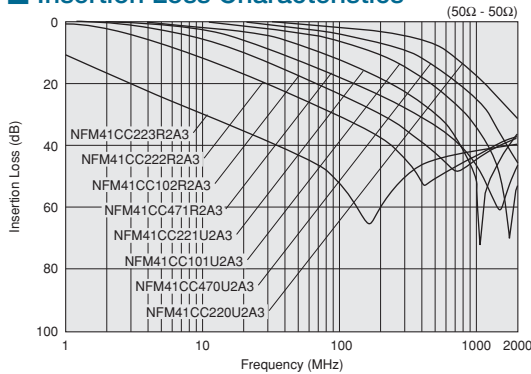

△Note • Please read rating and △CAUTION (for storage, operating, rating, soldering, mounting and handling) in this catalog to prevent smoking and/or burning, etc.
 • This catalog has only typical specifications. Therefore, please approve our product specifications or transact the approval sheet for product specifications before ordering.

Chip Ferrite Bead
 Chip EMIFIL® Signal Lines Type
 Chip Common Mode Choke Coil
 Block Type EMIFIL®
 Microwave Absorber

NFA31C Series (1206 Size)



4-line chip 3-terminal capacitor array, 1206 size.

■ Dimensions

(in mm)

■ Equivalent Circuit

Output (Input)
No polarity.

■ Packaging

Code	Packaging	Minimum Quantity
D	180mm Reel Paper Tape	4000
B	Bulk(Bag)	100

Refer to pages from p.147 to p.152 for mounting information.

■ Rated Value (□: packaging code)

Part Number	Capacitance	Rated Current	Rated Voltage	Insulation Resistance (min.)	Operating Temperature Range	
NFA31CC220S1E4□	22pF ±20%	200mA	25Vdc	1000M ohm	-40°C to +85°C	Kit
NFA31CC470S1E4□	47pF ±20%	200mA	25Vdc	1000M ohm	-40°C to +85°C	Kit
NFA31CC101S1E4□	100pF ±20%	200mA	25Vdc	1000M ohm	-40°C to +85°C	Kit
NFA31CC221S1E4□	220pF ±20%	200mA	25Vdc	1000M ohm	-40°C to +85°C	Kit
NFA31CC471R1E4□	470pF ±20%	200mA	25Vdc	1000M ohm	-40°C to +85°C	Kit
NFA31CC102R1E4□	1000pF ±20%	200mA	25Vdc	1000M ohm	-40°C to +85°C	Kit
NFA31CC222R1E4□	2200pF ±20%	200mA	25Vdc	1000M ohm	-40°C to +85°C	Kit
NFA31CC223R1C4□	22000pF ±20%	200mA	16Vdc	1000M ohm	-40°C to +85°C	Kit

Number of Circuit: 4

■ Insertion Loss Characteristics

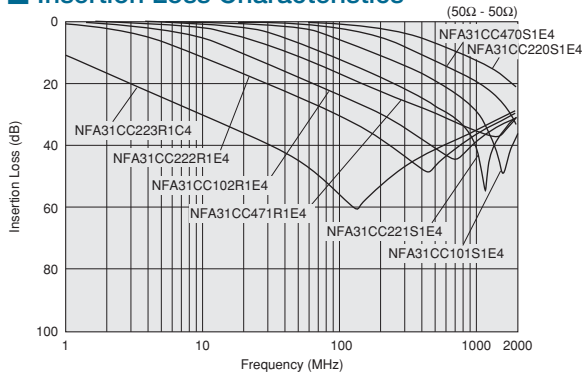

△Note • Please read rating and △CAUTION (for storage, operating, rating, soldering, mounting and handling) in this catalog to prevent smoking and/or burning, etc.
• This catalog has only typical specifications. Therefore, please approve our product specifications or transact the approval sheet for product specifications before ordering.

Chip Ferrite Bead

Signal Lines Type
Chip EMIFIL®

Chip Common Mode Choke Coil

Block Type EMIFIL®

Microwave Absorber

NFL15ST Series (0402 Size)



T-type LC filter, ultra-compact size of 1005mm



■ Dimensions

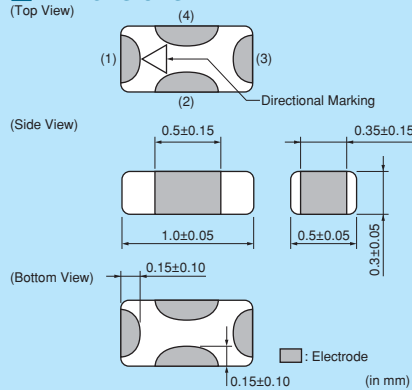

■ Equivalent Circuit

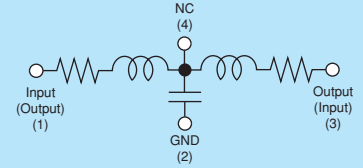

■ Packaging

Code	Packaging	Minimum Quantity
D	180mm Reel Paper Tape	10000
B	Bulk(Bag)	500

Refer to pages from p.147 to p.152 for mounting information.

■ Rated Value (□: packaging code)

Part Number	Nominal Cut-off Frequency	Capacitance	Inductance	Insertion Loss 1	Insertion Loss 2	Rated Current	Rated Voltage	
NFL15ST157X0J3□	150MHz	22pF (Typ.)	115nH (Typ.)	6dB max.(0 to 150MHz)	25dB min.(200 to 1000MHz)	50mA	6.3Vdc	Kit DTV
NFL15ST207X0J3□	200MHz	17pF (Typ.)	105nH (Typ.)	6dB max.(0 to 200MHz)	25dB min.(400 to 1000MHz)	50mA	6.3Vdc	Kit DTV
NFL15ST307X0J3□	300MHz	12pF (Typ.)	95nH (Typ.)	6dB max.(0 to 300MHz)	25dB min.(600 to 1000MHz)	50mA	6.3Vdc	Kit
NFL15ST507X0J3□	500MHz	7pF (Typ.)	60nH (Typ.)	6dB max.(0 to 500MHz)	25dB min.(600 to 1000MHz)	50mA	6.3Vdc	Kit

Insulation Resistance (min.): 1000M ohm Withstand Voltage: 18.9Vdc Operating Temperature Range: -40°C to +85°C Number of Circuits: 1

■ Insertion Loss Characteristics

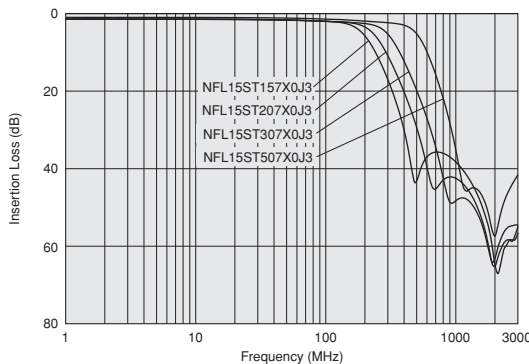

⚠Note • Please read rating and ⚠CAUTION (for storage, operating, rating, soldering, mounting and handling) in this catalog to prevent smoking and/or burning, etc.
• This catalog has only typical specifications. Therefore, please approve our product specifications or transact the approval sheet for product specifications before ordering.

Chip Ferrite Bead
 Chip EMIFIL® Signal Lines Type
 Chip Common Mode Choke Coil
 Block Type EMIFIL®
 Microwave Absorber

NFL18ST Series (0603 Size)



T-type LC filter. Reduces waveform distortion of high speed signal.

NFL18ST_H

■ Dimensions

(Top View)

(Side View)

(Bottom View)

Legend: Electrode (in mm)

*1 There are no electrical polarity. But there is a directional marking on the top of product to identify inner physical direction.

■ Equivalent Circuit

No Polarity.

■ Packaging

Code	Packaging	Minimum Quantity
D	180mm Reel Paper Tape	4000
B	Bulk(Bag)	1000

NFL18ST_X

■ Dimensions

Legend: Electrode (in mm)

■ Equivalent Circuit

No Polarity.

■ Packaging

Code	Packaging	Minimum Quantity
D	180mm Reel Paper Tape	4000
B	Bulk(Bag)	1000

Refer to pages from p.147 to p.152 for mounting information.

■ Rated Value (□: packaging code)

Part Number	Nominal Cut-off Frequency	Capacitance	Inductance	Insertion Loss 1	Insertion Loss 2	Rated Current	Rated Voltage	Kit	DTV
NFL18ST506H1A3□	50MHz	110pF (Typ.)	350nH (Typ.)	6dB max.(0 to 50MHz)	30dB min.(200 to 1000MHz)	75mA	10Vdc	Kit	DTV
NFL18ST706H1A3□	70MHz	70pF (Typ.)	230nH (Typ.)	6dB max.(0 to 70MHz)	30dB min.(300 to 1000MHz)	75mA	10Vdc	Kit	DTV
NFL18ST107H1A3□	100MHz	50pF (Typ.)	150nH (Typ.)	6dB max.(0 to 100MHz)	30dB min.(400 to 1000MHz)	75mA	10Vdc	Kit	DTV
NFL18ST207H1A3□	200MHz	22pF (Typ.)	110nH (Typ.)	6dB max.(0 to 200MHz)	30dB min.(800 to 2000MHz)	100mA	10Vdc	Kit	DTV
NFL18ST307H1A3□	300MHz	16pF (Typ.)	74nH (Typ.)	6dB max.(0 to 300MHz)	30dB min.(1200 to 2000MHz)	100mA	10Vdc	Kit	
NFL18ST507H1A3□	500MHz	10pF (Typ.)	42nH (Typ.)	6dB max.(0 to 500MHz)	30dB min.(1700 to 2000MHz)	100mA	10Vdc	Kit	

Insulation Resistance (min.): 1000M ohm Withstand Voltage: 30Vdc Operating Temperature Range: -55°C to +125°C Number of Circuits: 1

■ Insertion Loss Characteristics

NFL18ST_H Series

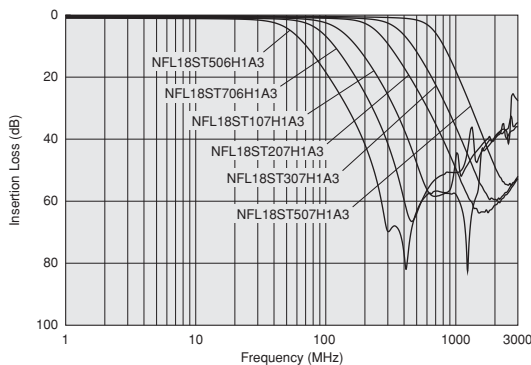

Continued on the following page.

⚠Note • Please read rating and ⚠CAUTION (for storage, operating, rating, soldering, mounting and handling) in this catalog to prevent smoking and/or burning, etc.
• This catalog has only typical specifications. Therefore, please approve our product specifications or transact the approval sheet for product specifications before ordering.

■ Rated Value (□: packaging code)

Part Number	Nominal Cut-off Frequency	Capacitance	Inductance	Rated Current	Rated Voltage	Insulation Resistance (min.)	Withstand Voltage	Operating Temperature Range	
NFL18ST207X1C3□	200MHz	25pF±20%	110nH±20%	150mA	16Vdc	1000M ohm	50Vdc	-55°C to +125°C	Kit
NFL18ST307X1C3□	300MHz	18pF±20%	62nH±20%	200mA	16Vdc	1000M ohm	50Vdc	-55°C to +125°C	Kit
NFL18ST507X1C3□	500MHz	10pF±20%	43nH±20%	200mA	16Vdc	1000M ohm	50Vdc	-55°C to +125°C	Kit

Number of Circuits: 1

■ Insertion Loss Characteristics

NFL18ST_X Series

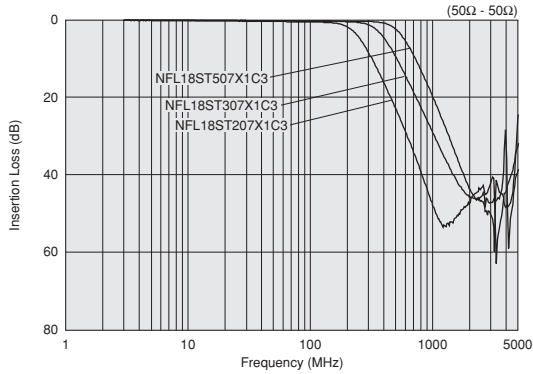

⚠Note • Please read rating and ⚠CAUTION (for storage, operating, rating, soldering, mounting and handling) in this catalog to prevent smoking and/or burning, etc.
• This catalog has only typical specifications. Therefore, please approve our product specifications or transact the approval sheet for product specifications before ordering.

Chip Ferrite Bead

Chip EMIFIL®
Signal Lines Type

Chip Common Mode Choke Coil

Block Type EMIFIL®

Microwave Absorber

NFL18SP Series (0603 Size)



PI-type LC filter. Reduces waveform distortion of high speed signal.

■ Dimensions

0.15±0.1
0.8±0.1
1.6±0.1
0.2 min.
0.3±0.1 0.4±0.1 0.3±0.1 0.15±0.1 0.15±0.1 0.6±0.1

■: Electrode (in mm)

■ Equivalent Circuit

Input (Output) (1) Output (Input) (3)
GND (2)
No polarity.

■ Packaging

Code	Packaging	Minimum Quantity
D	180mm Reel Paper Tape	4000
B	Bulk(Bag)	1000

Refer to pages from p.147 to p.152 for mounting information.

■ Rated Value (□: packaging code)

Part Number	Nominal Cut-off Frequency	Capacitance	Inductance	Rated Current	Rated Voltage	Insulation Resistance (min.)	Withstand Voltage	Operating Temperature Range	
NFL18SP157X1A3□	150MHz	34pF±20%	100nH±20%	100mA	10Vdc	1000M ohm	30Vdc	-55°C to +125°C	Kit
NFL18SP207X1A3□	200MHz	24pF±20%	80nH±20%	100mA	10Vdc	1000M ohm	30Vdc	-55°C to +125°C	Kit
NFL18SP307X1A3□	300MHz	19pF±20%	60nH±20%	100mA	10Vdc	1000M ohm	30Vdc	-55°C to +125°C	Kit
NFL18SP507X1A3□	500MHz	11pF±20%	38nH±20%	100mA	10Vdc	1000M ohm	30Vdc	-55°C to +125°C	Kit

Number of Circuits: 1

■ Insertion Loss Characteristics

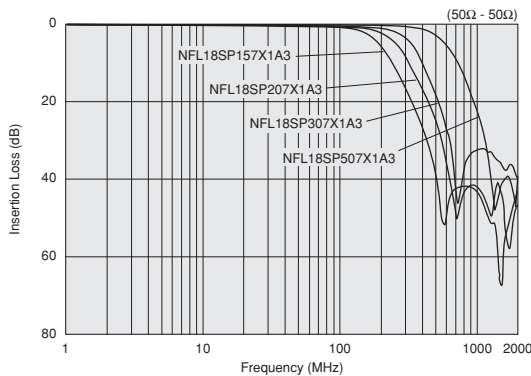

△Note • Please read rating and △CAUTION (for storage, operating, rating, soldering, mounting and handling) in this catalog to prevent smoking and/or burning, etc.
• This catalog has only typical specifications. Therefore, please approve our product specifications or transact the approval sheet for product specifications before ordering.

Chip Ferrite Bead

Signal Lines Type
Chip EMIFIL®

Chip Common Mode Choke Coil

Block Type EMIFIL®

Microwave Absorber

NFL21SP Series (0805 Size)



PI-type LC filter. Reduces waveform distortion of high speed signal.

■ Dimensions

0.3±0.2, 0.4±0.2, 0.85±0.1, 0.6±0.2, 2.0±0.2, 0.25±0.2, 1.25±0.1

Legend: Electrode (in mm)

■ Equivalent Circuit

Input (Output) (1), Output (Input) (3), GND (2), No polarity.

■ Packaging

Code	Packaging	Minimum Quantity
D	180mm Reel Paper Tape	4000
B	Bulk (Bag)	1000

Refer to pages from p.147 to p.152 for mounting information.

■ Rated Value (□: packaging code)

Part Number	Nominal Cut-off Frequency	Capacitance	Inductance	Rated Current	Rated Voltage	Insulation Resistance (min.)	Withstand Voltage	Operating Temperature Range	
NFL21SP106X1C3□	10MHz	670pF±20%	680nH±20%	100mA	16Vdc	1000M ohm	50Vdc	-55°C to +125°C	Kit
NFL21SP206X1C7□	20MHz	240pF±20%	700nH±20%	100mA	16Vdc	1000M ohm	50Vdc	-55°C to +125°C	Kit
NFL21SP506X1C3□	50MHz	84pF±20%	305nH±20%	150mA	16Vdc	1000M ohm	50Vdc	-55°C to +125°C	Kit
NFL21SP706X1C3□	70MHz	76pF±20%	185nH±20%	150mA	16Vdc	1000M ohm	50Vdc	-55°C to +125°C	Kit
NFL21SP107X1C3□	100MHz	44pF±20%	135nH±20%	200mA	16Vdc	1000M ohm	50Vdc	-55°C to +125°C	Kit
NFL21SP157X1C3□	150MHz	28pF±20%	128nH±20%	200mA	16Vdc	1000M ohm	50Vdc	-55°C to +125°C	Kit
NFL21SP207X1C3□	200MHz	22pF±20%	72nH±20%	250mA	16Vdc	1000M ohm	50Vdc	-55°C to +125°C	Kit
NFL21SP307X1C3□	300MHz	19pF±10%	45nH±10%	300mA	16Vdc	1000M ohm	50Vdc	-55°C to +125°C	Kit
NFL21SP407X1C3□	400MHz	16pF±10%	34nH±10%	300mA	16Vdc	1000M ohm	50Vdc	-55°C to +125°C	Kit
NFL21SP507X1C3□	500MHz	12pF±10%	31nH±10%	300mA	16Vdc	1000M ohm	50Vdc	-55°C to +125°C	Kit

Number of Circuits: 1

■ Insertion Loss Characteristics

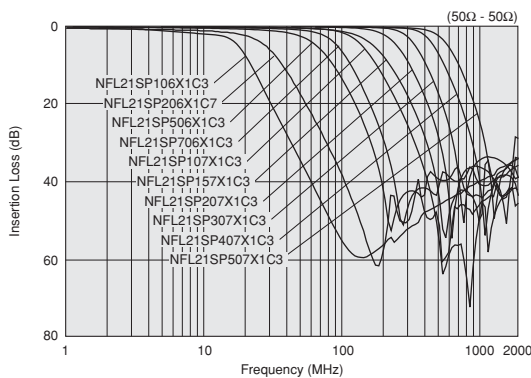

△Note • Please read rating and △CAUTION (for storage, operating, rating, soldering, mounting and handling) in this catalog to prevent smoking and/or burning, etc.
 • This catalog has only typical specifications. Therefore, please approve our product specifications or transact the approval sheet for product specifications before ordering.

Chip Ferrite Bead
 Chip EMIFIL® Signal Lines Type
 Chip Common Mode Choke Coil
 Block Type EMIFIL®
 Microwave Absorber

NFA18SL Series (0603 Size)



LC filter 4-line array for mobile phones.

NFA18SL 137/187/207/357 V1A45
NFA18SL506X1A45



■ Dimensions

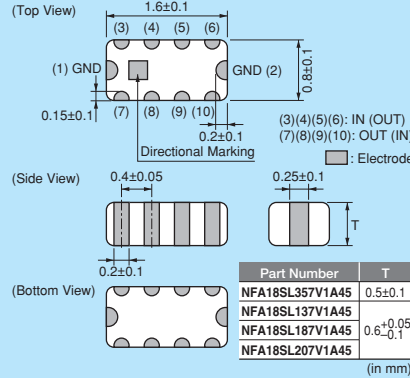

■ Equivalent Circuit

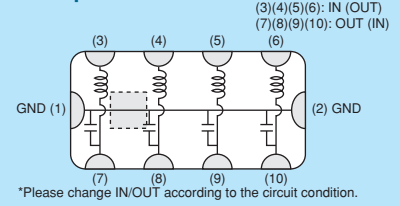

■ Packaging

Code	Packaging	Minimum Quantity
L	180mm Reel Embossed Tape	4000
B	Bulk(Bag)	1000

NFA18SL227V1A45



■ Dimensions

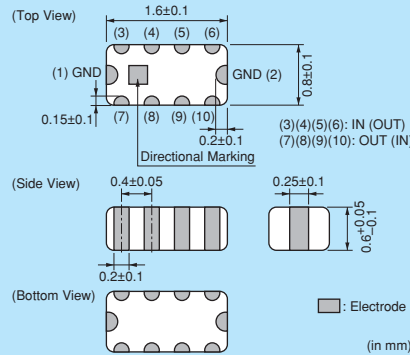

■ Equivalent Circuit

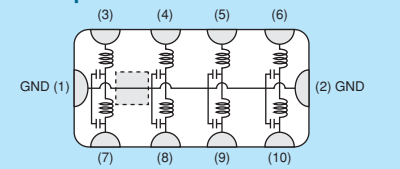

■ Packaging

Code	Packaging	Minimum Quantity
L	180mm Reel Embossed Tape	4000
B	Bulk(Bag)	1000

NFA18SL 307/407/487 V1A45



■ Dimensions

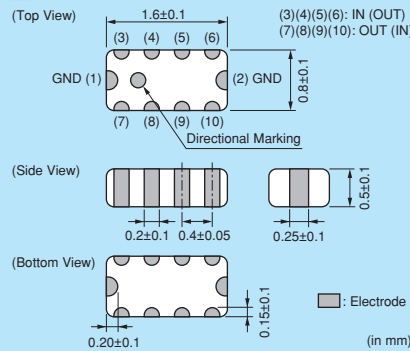

■ Equivalent Circuit

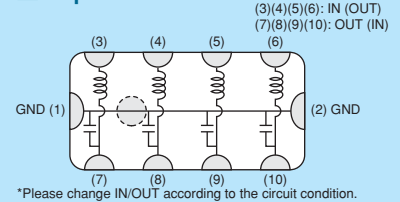

■ Packaging

Code	Packaging	Minimum Quantity
L	180mm Reel Embossed Tape	4000
B	Bulk(Bag)	1000

Refer to pages from p.147 to p.152 for mounting information.

■ Rated Value (□: packaging code)

Part Number	Nominal Cut-off Frequency	Insertion Loss (Cut-off Frequency)	Insertion Loss (470MHz) (min.)	Insertion Loss (800MHz) (min.)	Insertion Loss (900MHz) (min.)	Insertion Loss (2000MHz) (min.)	Rated Current	Rated Voltage	Insulation Resistance (min.)	Withstand Voltage	Kit	OTV
NFA18SL137V1A45□	130MHz	6dB max.	25dB	-	25dB	-	50mA	10Vdc	1000M ohm	30Vdc	Kit	OTV
NFA18SL187V1A45□	180MHz	6dB max.	20dB	-	20dB	-	50mA	10Vdc	1000M ohm	30Vdc	Kit	OTV
NFA18SL207V1A45□	200MHz	6dB max.	15dB	-	15dB	-	50mA	10Vdc	1000M ohm	30Vdc	Kit	OTV
NFA18SL227V1A45□	220MHz	6dB max.	-	-	30dB	30dB	25mA	10Vdc	1000M ohm	30Vdc	Kit	OTV
NFA18SL307V1A45□	300MHz	6dB max.	-	20dB	20dB	-	100mA	10Vdc	1000M ohm	30Vdc	Kit	
NFA18SL357V1A45□	350MHz	6dB max.	-	-	15dB	13dB	35mA	10Vdc	1000M ohm	30Vdc	Kit	
NFA18SL407V1A45□	400MHz	6dB max.	-	18dB	18dB	-	100mA	10Vdc	1000M ohm	30Vdc	Kit	
NFA18SL487V1A45□	480MHz	6dB max.	-	15dB	15dB	-	100mA	10Vdc	1000M ohm	30Vdc	Kit	

Operating Temperature Range: -40°C to +85°C (NFA18SL 137/187/207/227/357 V1A45), -55°C to +125°C (NFA18SL 307/407/487 V1A45) Number of Circuits: 4 Continued on the following page.

△Note • Please read rating and △CAUTION (for storage, operating, rating, soldering, mounting and handling) in this catalog to prevent smoking and/or burning, etc.
• This catalog has only typical specifications. Therefore, please approve our product specifications or transact the approval sheet for product specifications before ordering.

■ Insertion Loss Characteristics

NFA18SL 137/187/207 V1A45

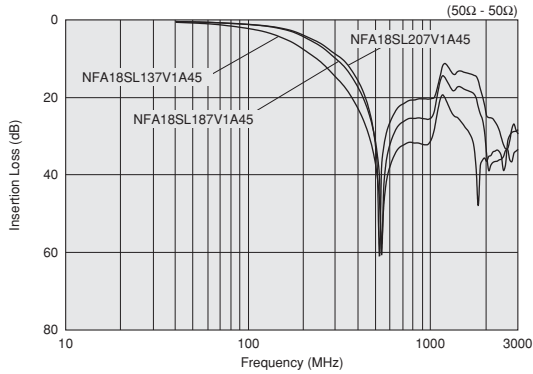

NFA18SL227V1A45

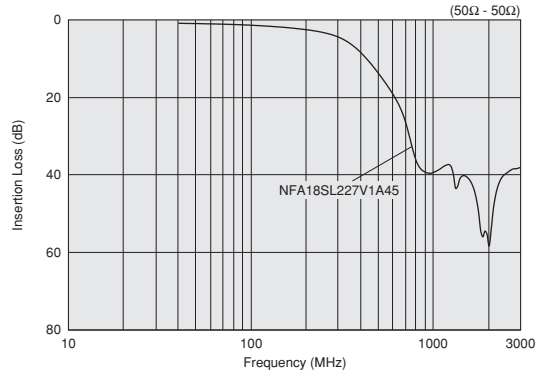

NFA18SL 307/407/487 V1A45

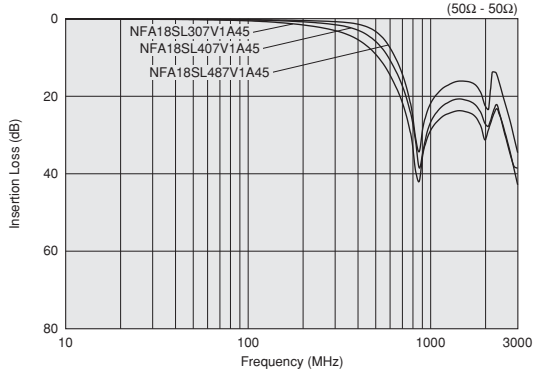

NFA18SL357V1A45

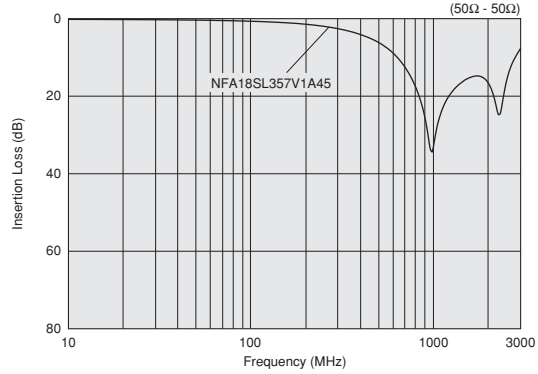

■ Rated Value (□: packaging code)

Part Number	Nominal Cut-off Frequency	Insertion Loss (Cut-off Frequency)	Insertion Loss (500MHz) (min.)	Insertion Loss (1000MHz) (min.)	Rated Current	Rated Voltage	Insulation Resistance (min.)	Withstand Voltage	
NFA18SL506X1A45□	50MHz	6dB max.	30dB	25dB	25mA	10Vdc	1000M ohm	30Vdc	Kit

Operating Temperature Range: -40°C to +85°C Number of Circuits: 4

■ Insertion Loss Characteristics

NFA18SL_X

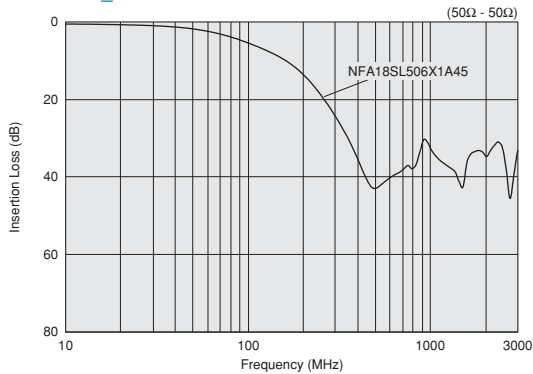

⚠Note • Please read rating and ⚠CAUTION (for storage, operating, rating, soldering, mounting and handling) in this catalog to prevent smoking and/or burning, etc.
• This catalog has only typical specifications. Therefore, please approve our product specifications or transact the approval sheet for product specifications before ordering.

Chip Ferrite Bead
Chip EMIFIL® Signal Lines Type
Chip Common Mode Choke Coil
Block Type EMIFIL®
Microwave Absorber

NFA21SL Series (0805 Size)



L-type LC filter 4-line array for mobile phones.



Dimensions

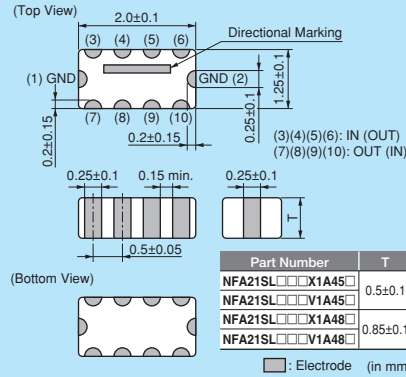

Equivalent Circuit

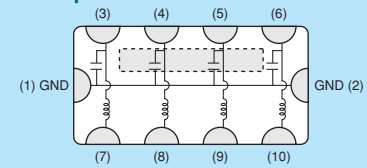

Packaging

Code	Packaging	Minimum Quantity
L	180mm Reel Embossed Tape	4000
B	Bulk(Bag)	1000

Refer to pages from p.147 to p.152 for mounting information.

Rated Value (□: packaging code)

Part Number	Nominal Cut-off Frequency	Insertion Loss (Cut-off Frequency)	Insertion Loss (800MHz) (min.)	Insertion Loss (900MHz) (min.)	Rated Current	Rated Voltage	Insulation Resistance (min.)	Withstand Voltage	
NFA21SL287V1A45□	280MHz	6dB max.	25dB	25dB	100mA	10Vdc	1000M ohm	30Vdc	Kit
NFA21SL317V1A45□	310MHz	6dB max.	20dB	20dB	100mA	10Vdc	1000M ohm	30Vdc	Kit
NFA21SL337V1A45□	330MHz	6dB max.	15dB	15dB	100mA	10Vdc	1000M ohm	30Vdc	Kit
NFA21SL287V1A48□	280MHz	6dB max.	25dB	25dB	100mA	10Vdc	1000M ohm	30Vdc	Kit
NFA21SL317V1A48□	310MHz	6dB max.	20dB	20dB	100mA	10Vdc	1000M ohm	30Vdc	Kit
NFA21SL337V1A48□	330MHz	6dB max.	20dB	20dB	100mA	10Vdc	1000M ohm	30Vdc	Kit

Operating Temperature Range: -55°C to +125°C Number of Circuits: 4

Insertion Loss Characteristics

NFA21SL_V1A45

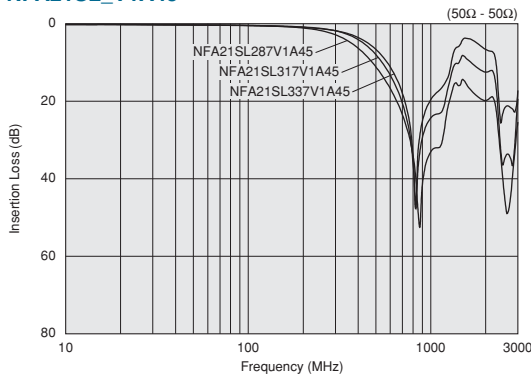

NFA21SL_V1A48

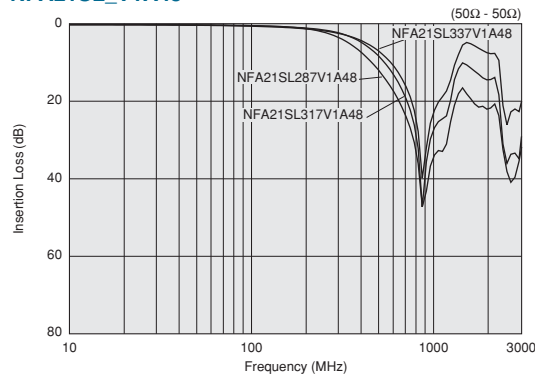

Continued on the following page. ↗

△Note • Please read rating and △CAUTION (for storage, operating, rating, soldering, mounting and handling) in this catalog to prevent smoking and/or burning, etc.
• This catalog has only typical specifications. Therefore, please approve our product specifications or transact the approval sheet for product specifications before ordering.

Chip Ferrite Bead
Chip EMIFIL® Signal Lines Type
Chip Common Mode Choke Coil
Block Type EMIFIL®
Microwave Absorber

■ Rated Value (□: packaging code)

Part Number	Nominal Cut-off Frequency	Insertion Loss (Cut-off Frequency)	Insertion Loss (500MHz) (min.)	Insertion Loss (800MHz) (min.)	Insertion Loss (1000MHz) (min.)	Rated Current	Rated Voltage	Insulation Resistance (min.)	Withstand Voltage	
NFA21SL207X1A45□	200MHz	2dB to 7dB	13dB	25dB	25dB	100mA	10Vdc	1000M ohm	30Vdc	Kit
NFA21SL307X1A45□	300MHz	2dB to 7dB	7dB	20dB	25dB	100mA	10Vdc	1000M ohm	30Vdc	Kit
NFA21SL506X1A48□	50MHz	0dB to 6dB	30dB	-	20dB	20mA	10Vdc	1000M ohm	30Vdc	Kit
NFA21SL806X1A48□	80MHz	2dB to 7dB	25dB	-	25dB	20mA	10Vdc	1000M ohm	30Vdc	Kit
NFA21SL207X1A48□	200MHz	2dB to 7dB	13dB	25dB	25dB	100mA	10Vdc	1000M ohm	30Vdc	Kit
NFA21SL307X1A48□	300MHz	2dB to 7dB	7dB	20dB	25dB	100mA	10Vdc	1000M ohm	30Vdc	Kit

Operating Temperature Range: -55°C to +125°C Number of Circuits: 4

■ Insertion Loss Characteristics

NFA21SL_X

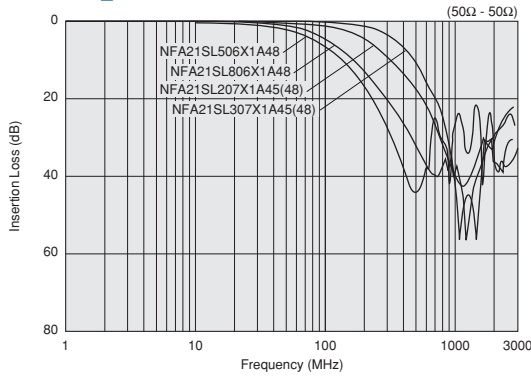

Chip Ferrite Bead

Signal Lines Type
 Chip EMIFIL®

Chip Common Mode Choke Coil

Block Type EMIFIL®

Microwave Absorber

⚠Note • Please read rating and ⚠CAUTION (for storage, operating, rating, soldering, mounting and handling) in this catalog to prevent smoking and/or burning, etc.
 • This catalog has only typical specifications. Therefore, please approve our product specifications or transact the approval sheet for product specifications before ordering.

NFW31S Series (1206 Size)



Wire-wound PI-type LC filter.



Dimensions

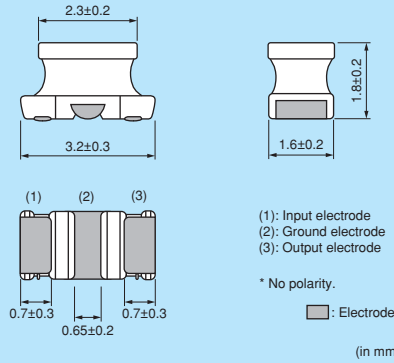

Equivalent Circuit

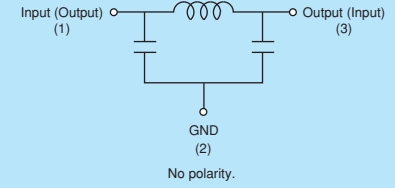

Packaging

Code	Packaging	Minimum Quantity
L	180mm Reel Embossed Tape	2000
K	330mm Reel Embossed Tape	7500

Refer to pages from p.147 to p.152 for mounting information.

Rated Value (□: packaging code)

Part Number	Nominal Cut-off Frequency	Insertion Loss at 10MHz	Insertion Loss at 20MHz	Insertion Loss at 50MHz	Insertion Loss at 100MHz	Insertion Loss at 150MHz	Insertion Loss at 200MHz	Insertion Loss at 300MHz	Insertion Loss at 400MHz	Insertion Loss at 500MHz	Insertion Loss at 1000MHz	Kit
NFW31SP106X1E4□	10MHz	6dB max.	5dB min.	25dB min.	25dB min.	-	25dB min.	-	-	30dB min.	30dB min.	Kit
NFW31SP206X1E4□	20MHz	-	6dB max.	5dB min.	25dB min.	-	25dB min.	-	-	30dB min.	30dB min.	Kit
NFW31SP506X1E4□	50MHz	-	-	6dB max.	10dB min.	-	30dB min.	-	-	30dB min.	30dB min.	Kit
NFW31SP107X1E4□	100MHz	-	-	-	6dB max.	-	5dB min.	-	-	20dB min.	30dB min.	Kit
NFW31SP157X1E4□	150MHz	-	-	-	-	6dB max.	-	10dB min.	20dB min.	30dB min.	30dB min.	Kit
NFW31SP207X1E4□	200MHz	-	-	-	-	-	6dB max.	-	-	10dB min.	30dB min.	Kit
NFW31SP307X1E4□	300MHz	-	-	-	-	-	-	6dB max.	-	5dB min.	15dB min.	Kit
NFW31SP407X1E4□	400MHz	-	-	-	-	-	-	-	6dB max.	-	10dB min.	Kit
NFW31SP507X1E4□	500MHz	-	-	-	-	-	-	-	-	6dB max.	10dB min.	Kit

Rated Current: 200mA Rated Voltage: 25Vdc Operating Temperature Range: -40°C to +85°C Number of Circuit: 1

Insertion Loss Characteristics

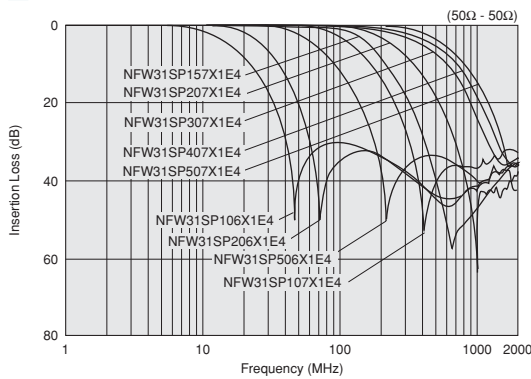

△Note • Please read rating and △CAUTION (for storage, operating, rating, soldering, mounting and handling) in this catalog to prevent smoking and/or burning, etc.
• This catalog has only typical specifications. Therefore, please approve our product specifications or transact the approval sheet for product specifications before ordering.

Chip Ferrite Bead

Chip EMIFIL®
Signal Lines Type

Chip Common Mode Choke Coil

Block Type EMIFIL®

Microwave Absorber

Example of EMI Suppression in an Actual Circuit

Measuring Circuit

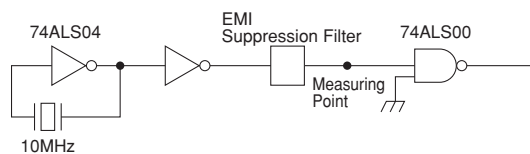

Type of Filter	Signal Wave Form (20ns/div / 1V/div) / EMI Suppression Effect / Description
Signal Waveform and Noise Spectrum before Filter Mounting	<p>Signal Waveform (20ns/div / 1V/div)</p> <p>Noise Spectrum (10:1 Active Probe)</p>
NFW31S Series (Cut-off frequency 50MHz)	<p>NFW31S's steep attenuation characteristic means excellent EMI suppression without waveform cornering.</p>
Conventional Chip Solid Type EMI Filter (NFM41CC 470pF)	<p>3-terminal capacitors suppress signal frequencies as EMI frequencies so the signal waveform is distorted.</p>
Filter Combined with Conventional LCs	<p>Combinations of inductors and capacitors can yield a steep attenuation characteristic, but they require a great deal more mounting space. Moreover, at high frequencies the EMI suppression is less than that obtained by NFW31S.</p>

△Note • Please read rating and △CAUTION (for storage, operating, rating, soldering, mounting and handling) in this catalog to prevent smoking and/or burning, etc.
• This catalog has only typical specifications. Therefore, please approve our product specifications or transact the approval sheet for product specifications before ordering.

NFR21G Series (0805 Size)



3-terminal RC filter, dampens the noise current and returns back to ground.

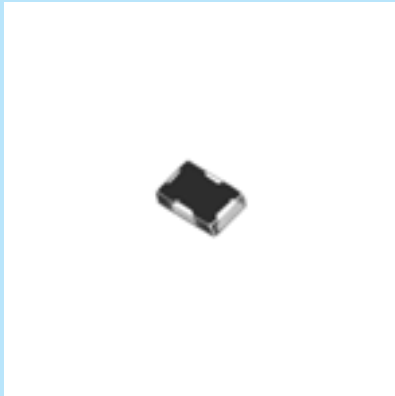

Dimensions

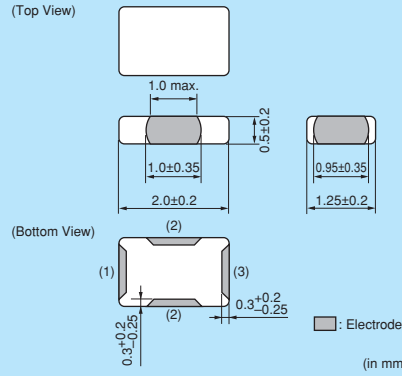

Equivalent Circuit

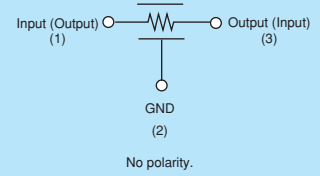

Packaging

Code	Packaging	Minimum Quantity
L	180mm Reel Embossed Tape	4000
B	Bulk (Bag)	500

Refer to pages from p.147 to p.152 for mounting information.

Rated Value (□: packaging code)

Part Number	Capacitance	Resistance	Rated Current	Rated Voltage	Insulation Resistance (min.)	Operating Temperature Range
NFR21GD1002202□	10pF ±20%	22ohm ±30%	50mA	50Vdc	1000M ohm	-40°C to +85°C
NFR21GD1004702□	10pF ±20%	47ohm ±30%	35mA	50Vdc	1000M ohm	-40°C to +85°C
NFR21GD4702202□	47pF ±20%	22ohm ±30%	50mA	50Vdc	1000M ohm	-40°C to +85°C
NFR21GD4704702□	47pF ±20%	47ohm ±30%	35mA	50Vdc	1000M ohm	-40°C to +85°C
NFR21GD4706802□	47pF ±20%	68ohm ±30%	30mA	50Vdc	1000M ohm	-40°C to +85°C
NFR21GD4701012□	47pF ±20%	100ohm ±30%	25mA	50Vdc	1000M ohm	-40°C to +85°C
NFR21GD1012202□	100pF ±20%	22ohm ±30%	50mA	50Vdc	1000M ohm	-40°C to +85°C
NFR21GD1014702□	100pF ±20%	47ohm ±30%	35mA	50Vdc	1000M ohm	-40°C to +85°C
NFR21GD1016802□	100pF ±20%	68ohm ±30%	30mA	50Vdc	1000M ohm	-40°C to +85°C
NFR21GD1011012□	100pF ±20%	100ohm ±30%	25mA	50Vdc	1000M ohm	-40°C to +85°C

Number of Circuit: 1

Insertion Loss Characteristics

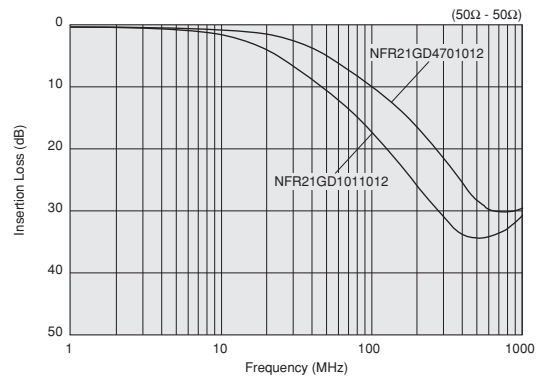
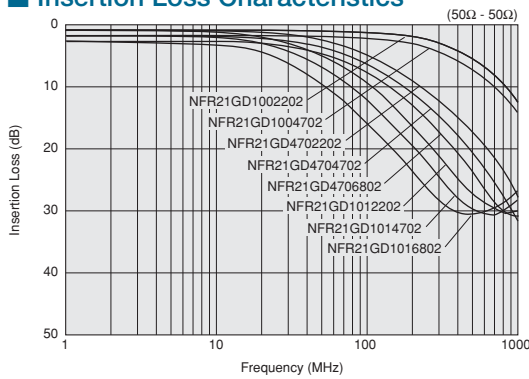

△Note • Please read rating and △CAUTION (for storage, operating, rating, soldering, mounting and handling) in this catalog to prevent smoking and/or burning, etc.
 • This catalog has only typical specifications. Therefore, please approve our product specifications or transact the approval sheet for product specifications before ordering.

Chip Ferrite Bead

Chip EMIFIL®
Signal Lines Type

Chip Common Mode Choke Coil

Block Type EMIFIL®

Microwave Absorber

NFA31G Series (1206 Size)



3-terminal RC filter array.

■ Dimensions

(Top View) (7) (8) (9) (10)

(Bottom View)

0.05 min. 0.05 min. (in mm)

■ Equivalent Circuit

Output (Input)
No polarity.

■ Packaging

Code	Packaging	Minimum Quantity
D	180mm Reel Paper Tape	4000
B	Bulk(Bag)	100

Refer to pages from p.147 to p.152 for mounting information.

■ Rated Value (□: packaging code)

Part Number	Capacitance	Resistance	Rated Current	Rated Voltage	Insulation Resistance (min.)	Operating Temperature Range
NFA31GD1006R84□	10pF ±20%	6.8ohm ±40%	50mA	6Vdc	1000M ohm	-40°C to +85°C
NFA31GD1004704□	10pF ±20%	47ohm ±30%	20mA	6Vdc	1000M ohm	-40°C to +85°C
NFA31GD1001014□	10pF ±20%	100ohm ±30%	15mA	6Vdc	1000M ohm	-40°C to +85°C
NFA31GD4706R84□	47pF ±20%	6.8ohm ±40%	50mA	6Vdc	1000M ohm	-40°C to +85°C
NFA31GD4703304□	47pF ±20%	33ohm ±30%	20mA	6Vdc	1000M ohm	-40°C to +85°C
NFA31GD4704704□	47pF ±20%	47ohm ±30%	20mA	6Vdc	1000M ohm	-40°C to +85°C
NFA31GD4701014□	47pF ±20%	100ohm ±30%	15mA	6Vdc	1000M ohm	-40°C to +85°C
NFA31GD1016R84□	100pF ±20%	6.8ohm ±40%	50mA	6Vdc	1000M ohm	-40°C to +85°C
NFA31GD1014704□	100pF ±20%	47ohm ±30%	20mA	6Vdc	1000M ohm	-40°C to +85°C
NFA31GD1011014□	100pF ±20%	100ohm ±30%	15mA	6Vdc	1000M ohm	-40°C to +85°C

Number of Circuit: 4

■ Insertion Loss Characteristics

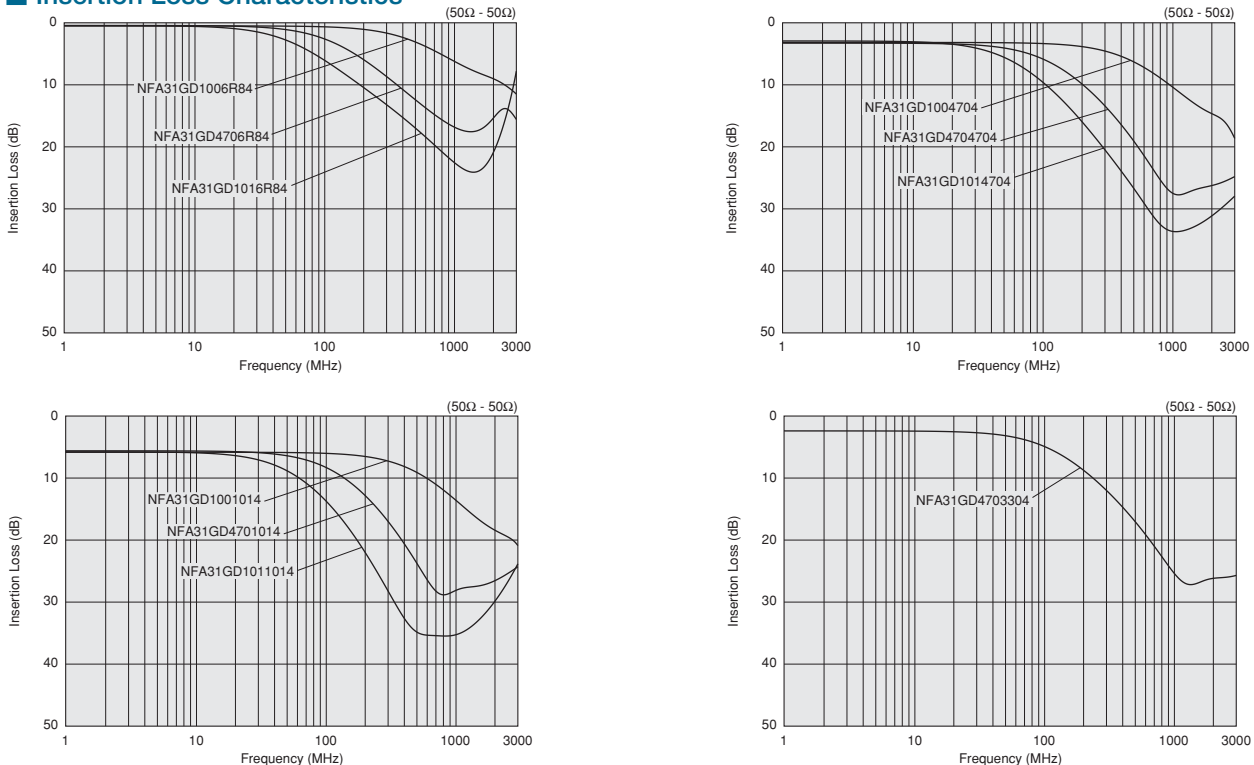

⚠Note • Please read rating and ⚠CAUTION (for storage, operating, rating, soldering, mounting and handling) in this catalog to prevent smoking and/or burning, etc.
• This catalog has only typical specifications. Therefore, please approve our product specifications or transact the approval sheet for product specifications before ordering.

Chip Ferrite Bead

Signal Lines Type
Chip EMIFIL®

Chip Common Mode Choke Coil

Block Type EMIFIL®

Microwave Absorber

⚠ Caution

● Rating

Do not use products beyond the rated current and rated voltage as this may create excessive heat and deteriorate the insulation resistance.

● Soldering and Mounting

1. Self-heating

Please provide special attention when mounting chip EMIFIL® NFM□□P/K series in close proximity to other products that radiate heat.

The heat generated by other products may deteriorate the insulation resistance and cause excessive heat in this component.

2. NFL15ST_X Series Mounting Direction

Mount products in right direction, because products have a direction. Wrong direction which is 180° rotated from right direction cause fuming or partial dispersion, because input or output signal terminals short-circuit to ground.

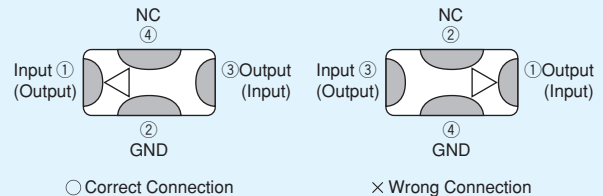

Notice

● Storage and Operating Conditions

<Operating Environment>

Do not use products in a chemical atmosphere such as chlorine gas, acid or sulfide gas.

Do not use products in the environment close to the organic solvent.

<Storage and Handling Requirements>

1. Storage Period

The other series should be used within 12 months.

Solderability should be checked if this period is exceeded.

2. Storage Conditions

(1) Storage temperature: -10 to +40°C

Relative humidity: 15 to 85%

Avoid sudden changes in temperature and humidity.

(2) Do not store products in a chemical atmosphere such as chlorine gas, acid or sulfide gas.

● Notice (Soldering and Mounting)

1. Cleaning

Failure and degradation of a product are caused by the cleaning method. When you clean in conditions that are not in mounting information, please contact Murata engineering.

2. Soldering

Reliability decreases with improper soldering methods. Please solder by the standard soldering conditions shown in mounting information.

3. Other

Noise suppression levels resulting from Murata's EMI suppression filters EMIFIL® may vary, depending on the circuits and ICs used, type of noise, mounting pattern, mounting location, and other operating conditions. Be sure to check and confirm in advance the noise suppression effect of each filter, in actual circuits, etc. before applying the filter in a commercial-purpose equipment design.

● Handling

1. Resin Coating

Using resin for coating/molding products may affect the products performance.

So please pay careful attention in selecting resin.

Prior to use, please make the reliability evaluation with the product mounted in your application set.

2. Caution for Use (NFW Series)

When you hold products with a tweezer, please hold by the sides. Sharp materials, such as a pair of tweezers or other material such as bristles of cleaning brush, should not touch the winding portion of this product to prevent breaking the wire. Mechanical shock should not be applied to the products mounted on the board to prevent breaking the core.

3. Handling of a Substrate

After mounting products on a substrate, do not apply any stress to the product caused by bending or twisting to the substrate when cropping the substrate, inserting and removing a connector from the substrate or tightening screw to the substrate. Excessive mechanical stress may cause cracking in the Product.

Bending

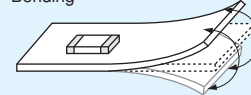

Twisting

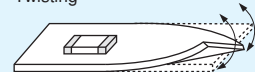

1. Standard Land Pattern Dimensions

NF□ series suppress noise by conducting the high-frequency noise element to ground. Therefore, to obtain maximum performance from these filters, the ground pattern should be made as large as possible during the PCB design stage. As shown below, one side of the PCB is used for chip mounting, and the other is used for grounding.

Small diameter feedthrough holes are then used to connect the grounds on each side of the PCB. This reduces the high-frequency impedance of the grounding and maximizes the filter's performance.

Land Pattern + Solder Resist
 Land Pattern
 Solder Resist
 (in mm)

NFM18
NFL15S
NFL18
NFM21C
NFM21P
NFR21G
NFL21S

Reflow Soldering
NFL15S

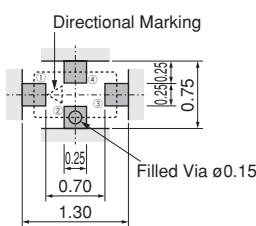

NFM18C/NFM18PC
NFL18ST

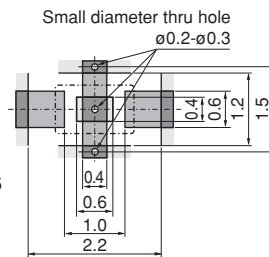

NFM18PS

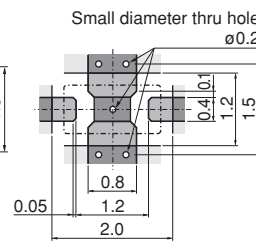

NFM21PS

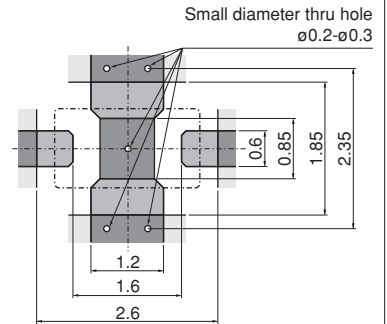

NFL18SP

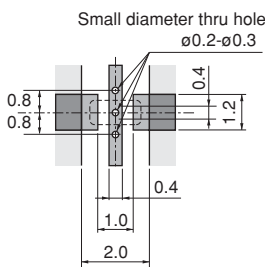

NFM21C/NFR21G
NFM21PC/NFL21S

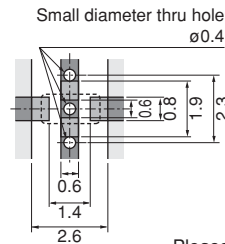

Please contact us if using thinner land pad than 18µm.

• NF□18, NF□21 are specially adapted for reflow soldering.

NFM3D
NFM31P
NFM31K
NFM41

● Reflow Soldering Chip mounting side

NFM3DC/NFM3DP/NFM31P/NFM41C/NFM41P

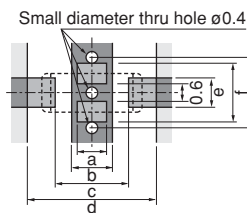

Part Number	Size (mm)						
	a	b	c	d	e	f	g
NFM3DC NFM3DP	1.0	1.4	2.5	4.4	1.0	2.0	2.4
NFM31P	1.0	1.4	2.5	4.4	1.2	2.6	3.0
NFM41C NFM41P	1.5	2.0	3.5	6.0	1.2	2.6	3.0

NFM31K*1

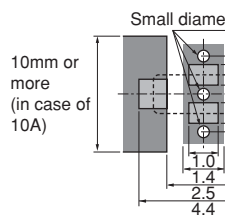

*1 For large current design, width of signal land pattern should be wider not less than 1mm per 1A (1mm/A). For example, in case of 10A, signal land pattern width should be 10mm or more. (1mm/A*10A=10mm)

● Flow Soldering Chip mounting side

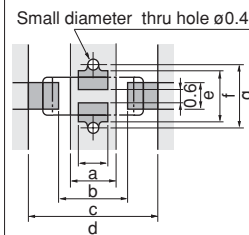

Part Number	Size (mm)						
	a	b	c	d	e	f	g
NFM3DC NFM3DP	1.0	1.4	2.5	4.4	1.0	2.0	2.4
NFM31P	1.0	1.4	2.5	4.4	1.2	2.6	3.0
NFM41C NFM41P	1.5	2.0	3.5	6.0	1.2	2.6	3.0

NFM31K*1

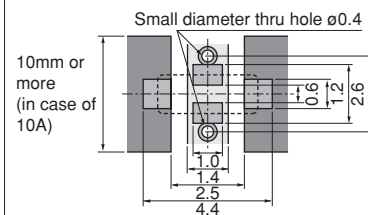

*1 For large current design, width of signal land pattern should be wider not less than 1mm per 1A (1mm/A). For example, in case of 10A, signal land pattern width should be 10mm or more. (1mm/A*10A=10mm)

Continued on the following page.

△Note • Please read rating and △CAUTION (for storage, operating, rating, soldering, mounting and handling) in this catalog to prevent smoking and/or burning, etc.
• This catalog has only typical specifications. Therefore, please approve our product specifications or transact the approval sheet for product specifications before ordering.

Land Pattern + Solder Resist

 Land Pattern

 Solder Resist

 (in mm)

<p>NFA18S NFA21S</p>	<p>Reflow Soldering</p> <p>NFA18S</p>	<p>NFA21S</p> <p>Small diameter thru hole ø0.2</p>
<p>NFA31G NFA31C NFW31S NFE31P</p>	<p>● Reflow Soldering NFA31G/31C</p> <p>R0.1 to R0.2 is preferred to obtain high voltage withstanding</p>	<p>● Reflow and Flow NFW31S</p> <p>● Reflow Soldering NFE31P</p> <p>Small diameter thru hole ø0.4</p>
<p>NFE61P</p>	<p>● Reflow Soldering</p> <p>Small diameter thru hole ø0.4</p>	<p>● Flow Soldering</p> <p>Small diameter thru hole ø0.4</p>

- PCB Warping
PCB should be designed so that products are not subjected to the mechanical stress caused by warping the board.

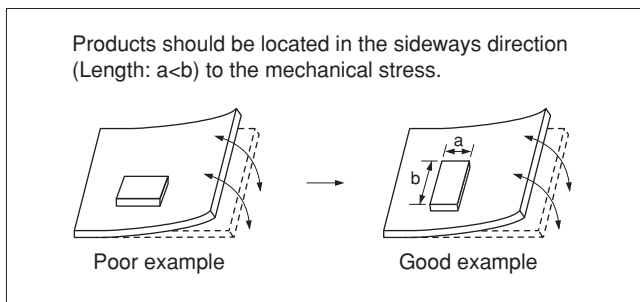

⚠Note • Please read rating and ⚠CAUTION (for storage, operating, rating, soldering, mounting and handling) in this catalog to prevent smoking and/or burning, etc.
 • This catalog has only typical specifications. Therefore, please approve our product specifications or transact the approval sheet for product specifications before ordering.

Chip Ferrite Bead
 Soldering and Mounting
 Chip EMIFIL®
 Chip Common Mode Choke Coil
 Block Type EMIFIL®
 Microwave Absorber

2. Solder Paste Printing and Adhesive Application

When reflow soldering the chip EMI suppression filter, the printing must be conducted in accordance with the following cream solder printing conditions.



If too much solder is applied, the chip will be prone to damage by mechanical and thermal stress from the PCB and may crack.

Standard land dimensions should be used for resist and copper foil patterns.

When flow soldering the EMI suppression filter, apply the adhesive in accordance with the following conditions.

If too much adhesive is applied, then it may overflow into the land or termination areas and yield poor solderability. In contrast, if insufficient adhesive is applied, or if the adhesive is not sufficiently hardened, then the chip may become detached during flow soldering process.

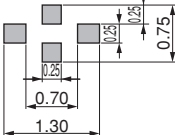
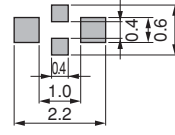
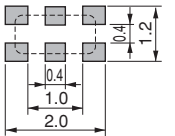
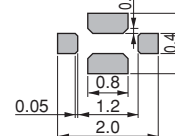
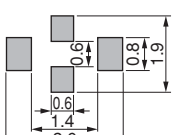
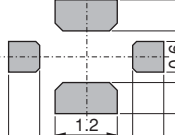
(in mm)

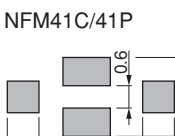
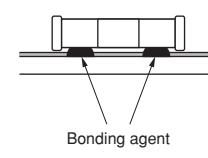
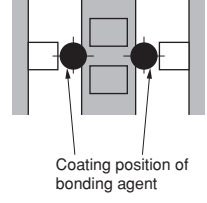
Series	Solder Paste Printing	Adhesive Application
<p>NFM NFR NFL</p>	<p>● Guideline of solder paste thickness: 100-150µm: NFM18/21/3D/31P, NFR, NFL 100-200µm: NFM41</p> <div style="display: flex; flex-wrap: wrap;"> <div style="width: 50%;"> <p>NFL15S</p>  </div> <div style="width: 50%;"> <p>NFM18C/18PC NFL18ST</p>  </div> <div style="width: 50%;"> <p>NFL18SP</p>  </div> <div style="width: 50%;"> <p>NFM18PS</p>  </div> <div style="width: 50%;"> <p>NFM21C/21PC NFR21G/NFL21S</p>  </div> <div style="width: 50%;"> <p>NFM21PS</p>  </div> <div style="width: 50%;"> <p>NFM3DC/3DP</p>  </div> <div style="width: 50%;"> <p>NFM31P/31K</p>  </div> <div style="width: 50%;"> <p>NFM41C/41P</p>  </div> </div>	<p>■ NFM3D/31/41 Series Apply 0.1mg for NFM41C/41 and 0.06mg for NFM3D/NFM31 of bonding agent at each chip. Do not cover electrodes.</p> <div style="display: flex; justify-content: space-around;">   </div>

Continued on the following page.

⚠ Note • Please read rating and ⚠ CAUTION (for storage, operating, rating, soldering, mounting and handling) in this catalog to prevent smoking and/or burning, etc.
• This catalog has only typical specifications. Therefore, please approve our product specifications or transact the approval sheet for product specifications before ordering.

(in mm)

Series	Solder Paste Printing	Adhesive Application
<p>NFA</p>	<p>●Guideline of solder paste thickness: 100-200µm: NFA31G/31C 100-150µm: NFA18S/21S</p>	
<p>NFW31S NFE31P</p>	<p>●Guideline of solder paste thickness: 150-200µm</p>	<p>■ NFW31S Series Apply 0.2mg of bonding agent at each chip.</p>
<p>NFE61P</p>	<p>●Guideline of solder paste thickness: 150-200µm</p>	<p>Apply 1.0mg of bonding agent at each chip.</p>

△Note • Please read rating and △CAUTION (for storage, operating, rating, soldering, mounting and handling) in this catalog to prevent smoking and/or burning, etc.
 • This catalog has only typical specifications. Therefore, please approve our product specifications or transact the approval sheet for product specifications before ordering.

Chip Ferrite Bead
 Soldering and Mounting
 Chip EMIFIL®
 Chip Common Mode Choke Coil
 Block Type EMIFIL®
 Microwave Absorber

3. Standard Soldering Conditions

(1) Soldering Methods

Use flow and reflow soldering methods only.
 Use standard soldering conditions when soldering chip EMI suppression filters.
 In cases where several different parts are soldered, each having different soldering conditions, use those conditions requiring the least heat and minimum time.

Solder: Use Sn-3.0Ag-0.5Cu solder. Use of Sn-Zn based solder will deteriorate performance of products.
 If using NFM series with Sn-Zn based solder, please contact Murata in advance.

Flux:

- Use Rosin-based flux.
 In case of using RA type solder, products should be cleaned completely with no residual flux.
- Do not use strong acidic flux (with chlorine content exceeding 0.20wt%)
- Do not use water-soluble flux.

For additional mounting methods, please contact Murata.

(2) Soldering Profile

● Flow Soldering Profile (Sn-3.0Ag-0.5Cu Solder)

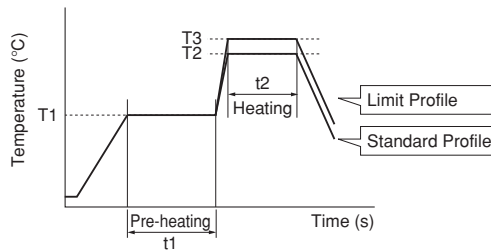

Series	Pre-heating		Standard Profile			Limit Profile		
	Temp. (T1)	Time. (t1)	Heating		Cycle of Flow	Heating		Cycle of Flow
			Temp. (T2)	Time. (t2)		Temp. (T3)	Time. (t2)	
NFM3D/31/41 NFE61P	150°C	60s min.	250°C	4 to 6s	2 times max.	265±3°C	5s max.	2 times max.
NFW31S	150°C	60s min.	250°C	4 to 6s	2 times max.	265±3°C	5s max.	1 time

● Reflow Soldering Profile (Sn-3.0Ag-0.5Cu Solder)

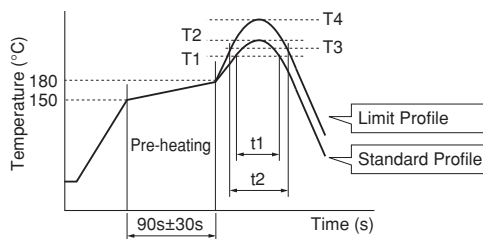

Series	Standard Profile				Limit Profile			
	Heating		Peak Temperature (T2)	Cycle of Reflow	Heating		Peak Temperature (T4)	Cycle of Reflow
	Temp. (T1)	Time. (t1)			Temp. (T3)	Time. (t2)		
NFA, NFE NFL, NFM NFR	220°C min.	30 to 60s	245±3°C	2 times max.	230°C min.	60s max.	260°C/10s	2 times max.
NFW31S	220°C min.	30 to 60s	245±3°C	2 times max.	230°C min.	60s max.	260°C/10s	1 time

△Note • Please read rating and △CAUTION (for storage, operating, rating, soldering, mounting and handling) in this catalog to prevent smoking and/or burning, etc.
 • This catalog has only typical specifications. Therefore, please approve our product specifications or transact the approval sheet for product specifications before ordering.

Chip Ferrite Bead
 Chip EMIFIL® Soldering and Mounting
 Chip Common Mode Choke Coil
 Block Type EMIFIL®
 Microwave Absorber

(3) Reworking with Solder Iron

The following conditions must be strictly followed when using a soldering iron.

Pre-heating: 150°C 60s min.

Soldering iron power output / Tip diameter:

30W max. / ø3mm max.

Temperature of soldering iron tip / Soldering time / Times:

350°C max. / 3-4s / 2 times*¹

*¹ NFE31PT152Z1E9: 280°C max. / 10s max. / 2 times

Do not allow the tip of the soldering iron to directly contact the chip.

For additional methods of reworking with a soldering iron, please contact Murata engineering.

4. Cleaning

Following conditions should be observed when cleaning chip EMI filter.

(1) Cleaning Temperature: 60°C max. (40°C max. for alcohol type cleaner)

(2) Ultrasonic

Output: 20W/liter max.

Duration: 5 minutes max.

Frequency: 28 to 40kHz

(3) Cleaning Agent

The following list of cleaning agents have been tested on the individual components. Evaluation of final assembly should be completed prior to production.

(a) Alcohol cleaning agent

Isopropyl alcohol (IPA)

(b) Aqueous cleaning agent

Pine Alpha ST-100S

(4) Ensure that flux residue is completely removed.

Component should be thoroughly dried after aqueous agent has been removed with deionized water.

Minimum Quantity and Dimensions of 8mm Width Paper / Embossed Tape

(Paper Tape)

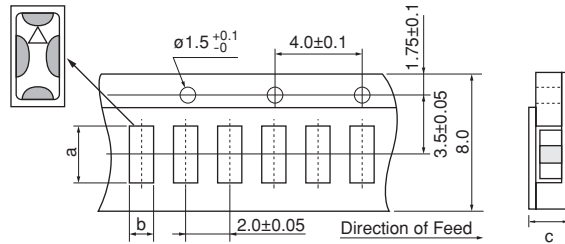

c: Total Thickness of Tape

Part Number	Dimensions				Minimum Qty. (pcs.)				Bulk
					ø180mm Reel		ø330mm Reel		
	a	b	c	d	Paper Tape	Embossed Tape	Paper Tape	Embossed Tape	
NFL15ST	1.12	0.62	0.8 max.	-	10000	-	-	-	500

(in mm)

(Common to Paper Tape / Embossed Tape)

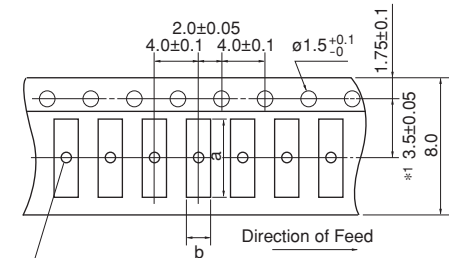

<Embossed>

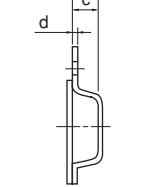

c: Depth of Cavity (Embossed Tape)

<Paper>



c: Total Thickness of Tape (Paper Tape)

There are holes in the cavities of the NFM31, NFA18S and NFA21S_48 only.
 NFA18S: $\phi 0.8 \pm 0.1$, NFA21S_48: $\phi 1.0 \pm 0.2$
 NFM31: $\phi 1.0 \pm 0.2$

*1 NFM31: 3.5 ± 0.1

Dimension of the cavity of embossed tape is measured at the bottom side.

Part Number	Dimensions				Minimum Qty. (pcs.)				Bulk
					ø180mm Reel		ø330mm Reel		
	a	b	c	d	Paper Tape	Embossed Tape	Paper Tape	Embossed Tape	
NFM18CC/ NFM18PC (Except for 105R/225B1A) NFM18PS	1.85	1.05	0.9 max.	-	4000	-	-	-	500
NFM18PC105R/225B1A			1.1 max.	-	4000	-	-	-	500
NFL18SP/NFL18ST_H NFL18ST_X	1.85	1.05	0.9 max.	-	4000	-	-	-	1000
NFL21SP			1.1 max.	-					
NFM21	2.3	1.55	1.1 max.	-	4000	-	-	-	500
NFM3D	3.4	1.4	0.85	0.2	-	4000	-	-	500
NFM31	3.5	1.9	1.5	0.25	-	3000	-	-	500
NFA18SL/SD	1.8	1.0	0.7	0.25	-	4000	-	-	1000
NFA21SL_45	2.30	1.55	0.7	0.25	-	4000	-	-	1000
NFA21SL_48	2.25	1.45	1.05	0.25	-	4000	-	-	1000
NFA31GD/31CC	3.5	2.0	1.1 max.	-	4000	-	-	-	100
NFE31PT	3.6	1.8	1.85	0.2	-	2000	-	8000	500
NFR21GD	2.3	1.55	0.7	0.25	-	4000	-	-	500
NFW31SP	3.6	1.9	2.0	0.2	-	2000	-	7500	-

(in mm)

"Minimum Quantity" means the number of units of each delivery or order. The quantity should be an integral multiple of the "Minimum Quantity."

Continued on the following page.

△Note • Please read rating and CAUTION (for storage, operating, rating, soldering, mounting and handling) in this catalog to prevent smoking and/or burning, etc.
 • This catalog has only typical specifications. Therefore, please approve our product specifications or transact the approval sheet for product specifications before ordering.

■ Minimum Quantity and Dimensions of 12mm Width Embossed Tape

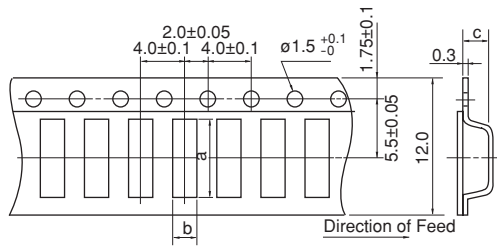

Part Number	Dimensions			Minimum Qty. (pcs.)		
	a	b	c	ø180mm Reel	ø330mm Reel	Bulk
NFM41	4.8	1.8	1.1	4000	-	500
NFE61	7.2	1.9	1.75	2500	8000	500

Dimension of the cavity is measured at the bottom side.

(in mm)

"Minimum Quantity" means the number of units of each delivery or order. The quantity should be an integral multiple of the "Minimum Quantity."

△Note • Please read rating and △CAUTION (for storage, operating, rating, soldering, mounting and handling) in this catalog to prevent smoking and/or burning, etc.
• This catalog has only typical specifications. Therefore, please approve our product specifications or transact the approval sheet for product specifications before ordering.

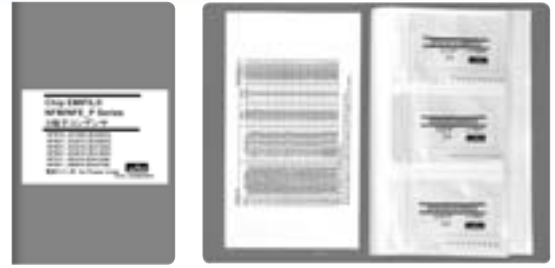

●EKEMNFMCB (Chip EMIFIL® Capacitor Type for Signal Lines)

No.	Part Number	Quantity (pcs.)	Capacitance	Rated Voltage (Vdc)	Rated Current (mA)
1	NFM18CC220U1C3	10	22pF±20%	16	400
2	NFM18CC470U1C3	10	47pF±20%	16	400
3	NFM18CC101R1C3	10	100pF±20%	16	500
4	NFM18CC221R1C3	10	220pF±20%	16	500
5	NFM18CC471R1C3	10	470pF±20%	16	500
6	NFM18CC102R1C3	10	1000pF±20%	16	600
7	NFM18CC222R1C3	10	2200pF±20%	16	700
8	NFM18CC223R1C3	10	22000pF±20%	16	1000
9	NFM21CC220U1H3	10	22pF±20%	50	700
10	NFM21CC470U1H3	10	47pF±20%	50	700
11	NFM21CC101U1H3	10	100pF±20%	50	700
12	NFM21CC221R1H3	10	220pF±20%	50	700
13	NFM21CC471R1H3	10	470pF±20%	50	1000
14	NFM21CC102R1H3	10	1000pF±20%	50	1000
15	NFM21CC222R1H3	10	2200pF±20%	50	1000
16	NFM21CC223R1H3	10	22000pF±20%	50	2000

●EKEMFA31E (Chip EMIFIL® Capacitor Array Type/ RC Combined Array Type)

No.	Part Number	Quantity (pcs.)	Capacitance	Rated Voltage (Vdc)	Rated Current (mA)
1	NFA31CC220S1E4	10	22pF±20%	25	200
2	NFA31CC470S1E4	10	47pF±20%	25	200
3	NFA31CC101S1E4	10	100pF±20%	25	200
4	NFA31CC221S1E4	10	220pF±20%	25	200
5	NFA31CC471R1E4	10	470pF±20%	25	200
6	NFA31CC102R1E4	10	1000pF±20%	25	200
7	NFA31CC222R1E4	10	2200pF±20%	25	200
8	NFA31CC223R1C4	10	22000pF±20%	16	200

●EKEMFL18G (Chip EMIFIL® LC Combined Type)

No.	Part Number	Quantity (pcs.)	Cut-off Frequency	Rated Voltage (Vdc)	Rated Current (mA)
1	NFL15ST157X0J3	10	150MHz	6.3	50
2	NFL15ST207X0J3	10	200MHz	6.3	50
3	NFL15ST307X0J3	10	300MHz	6.3	50
4	NFL15ST507X0J3	10	500MHz	6.3	50
5	NFL18ST506H1A3	10	50MHz	10	75
6	NFL18ST706H1A3	10	70MHz	10	75
7	NFL18ST107H1A3	10	100MHz	10	75
8	NFL18ST207H1A3	10	200MHz	10	100
9	NFL18ST307H1A3	10	300MHz	10	100
10	NFL18ST507H1A3	10	500MHz	10	100
11	NFL18ST207X1C3	10	200MHz	16	150
12	NFL18ST307X1C3	10	300MHz	16	200
13	NFL18ST507X1C3	10	500MHz	16	200
14	NFL18SP157X1A3	10	150MHz	10	100
15	NFL18SP207X1A3	10	200MHz	10	100
16	NFL18SP307X1A3	10	300MHz	10	100
17	NFL18SP507X1A3	10	500MHz	10	100
18	NFL21SP106X1C3	10	10MHz	16	100
19	NFL21SP206X1C7	10	20MHz	16	100
20	NFL21SP506X1C3	10	50MHz	16	150
21	NFL21SP706X1C3	10	70MHz	16	150
22	NFL21SP107X1C3	10	100MHz	16	200
23	NFL21SP157X1C3	10	150MHz	16	200

Continued on the following page.

△Note • Please read rating and △CAUTION (for storage, operating, rating, soldering, mounting and handling) in this catalog to prevent smoking and/or burning, etc.
• This catalog has only typical specifications. Therefore, please approve our product specifications or transact the approval sheet for product specifications before ordering.

Continued from the preceding page.

No.	Part Number	Quantity (pcs.)	Cut-off Frequency	Rated Voltage (Vdc)	Rated Current (mA)
24	NFL21SP207X1C3	10	200MHz	16	250
25	NFL21SP307X1C3	10	300MHz	16	300
26	NFL21SP407X1C3	10	400MHz	16	300
27	NFL21SP507X1C3	10	500MHz	16	300

No.	Part Number	Quantity (pcs.)	Cut-off Frequency	Attenuation (dB min.)										Rated Current	Rated Voltage	
				10MHz	20MHz	50MHz	100MHz	150MHz	200MHz	300MHz	400MHz	500MHz	1GHz			
28	NFW31SP106X1E4	10	10MHz	6dB max.	5	25	25	-	25	-	-	-	30	30	200mA	25V
29	NFW31SP206X1E4	10	20MHz	-	6dB max.	5	25	-	25	-	-	-	30	30	200mA	25V
30	NFW31SP506X1E4	10	50MHz	-	-	6dB max.	10	-	30	-	-	-	30	30	200mA	25V
31	NFW31SP107X1E4	10	100MHz	-	-	-	6dB max.	-	5	-	-	-	20	30	200mA	25V
32	NFW31SP157X1E4	10	150MHz	-	-	-	-	6dB max.	-	10	-	-	30	30	200mA	25V
33	NFW31SP207X1E4	10	200MHz	-	-	-	-	-	6dB max.	-	-	-	10	30	200mA	25V
34	NFW31SP307X1E4	10	300MHz	-	-	-	-	-	-	-	6dB max.	-	5	15	200mA	25V
35	NFW31SP407X1E4	10	400MHz	-	-	-	-	-	-	-	-	6dB max.	-	10	200mA	25V
36	NFW31SP507X1E4	10	500MHz	-	-	-	-	-	-	-	-	-	6dB max.	10	200mA	25V

●EKEMFA20H (Chip EMIFIL® LC Combined Array Type)

No.	Part Number	Quantity (pcs.)	Cut-off Frequency	Rated Voltage (Vdc)	Rated Current (mA)
1	NFA18SL506X1A45	10	50MHz	10	25
2	NFA18SL137V1A45	10	130MHz	10	50
3	NFA18SL187V1A45	10	180MHz	10	50
4	NFA18SL207V1A45	10	200MHz	10	50
5	NFA18SL227V1A45	10	220MHz	10	25
6	NFA18SL307V1A45	10	300MHz	10	100
7	NFA18SL357V1A45	10	350MHz	10	35
8	NFA18SL407V1A45	10	400MHz	10	100
9	NFA18SL487V1A45	10	480MHz	10	100
10	NFA18SD187X1A45	10	180MHz	10	25
11	NFA18SD207X1A45	10	200MHz	10	25
12	NFA21SL506X1A48	10	50MHz	10	20
13	NFA21SL806X1A48	10	80MHz	10	20
14	NFA21SL207X1A45	10	200MHz	10	100
15	NFA21SL207X1A48	10	200MHz	10	100
16	NFA21SL307X1A45	10	300MHz	10	100
17	NFA21SL307X1A48	10	300MHz	10	100
18	NFA21SL287V1A45	10	280MHz	10	100
19	NFA21SL287V1A48	10	280MHz	10	100
20	NFA21SL317V1A45	10	310MHz	10	100
21	NFA21SL317V1A48	10	310MHz	10	100
22	NFA21SL337V1A45	10	330MHz	10	100
23	NFA21SL337V1A48	10	330MHz	10	100

●EKEMNFMPPM (Chip EMIFIL® for Large Current)

No.	Part Number	Quantity (pcs.)	Capacitance	Rated Voltage (Vdc)	Rated Current (A)
1	NFM18PC104R1C3	10	0.1μF±20%	16	2
2	NFM18PC224R0J3	10	0.22μF±20%	6.3	2
3	NFM18PC474R0J3	10	0.47μF±20%	6.3	2
4	NFM18PC105R0J3	10	1μF±20%	6.3	4
5	NFM18PC225B0J3	10	2.2μF±20%	6.3	2
6	NFM18PC225B1A3	10	2.2μF±20%	10	4
7	NFM18PS474R0J3	10	0.47μF±20%	6.3	2
8	NFM18PS105R0J3	10	1μF±20%	6.3	2
9	NFM21PC104R1E3	10	0.1μF±20%	25	2
10	NFM21PC224R1C3	10	0.22μF±20%	16	2
11	NFM21PC474R1C3	10	0.47μF±20%	16	2
12	NFM21PC105B1A3	10	1μF±20%	10	4
13	NFM21PC105B1C3	10	1μF±20%	16	4
14	NFM21PC225B0J3	10	2.2μF±20%	6.3	4
15	NFM21PC475B1A3	10	4.7μF±20%	10	6
16	NFM21PS106B0J3	10	10μF±20%	6.3	4
17	NFM31PC276B0J3	10	27μF±20%	6.3	6
18	NFM41PC204F1H3	10	0.2μF+80/-20%	50	2

Continued on the following page.

△Note • Please read rating and △CAUTION (for storage, operating, rating, soldering, mounting and handling) in this catalog to prevent smoking and/or burning, etc.
• This catalog has only typical specifications. Therefore, please approve our product specifications or transact the approval sheet for product specifications before ordering.

Chip Ferrite Bead

Design Kits
Chip EMIFIL®

Chip Common Mode Choke Coil

Block Type EMIFIL®

Microwave Absorber

Continued from the preceding page.

No.	Part Number	Quantity (pcs.)	Capacitance	Rated Voltage (Vdc)	Rated Current (A)
19	NFM41PC155B1E3	10	1.5μF±20%	25	6
20	NFM31KC103R1H3	10	10000pF±20%	50	10
21	NFM31KC103R2A3	10	10000pF±20%	100	10
22	NFM31KC153R1H3	10	15000pF±20%	50	10
23	NFM31KC153R2A3	10	15000pF±20%	100	10
24	NFM31KC223R1H3	10	22000pF±20%	50	10
25	NFM31KC223R2A3	10	22000pF±20%	100	10
26	NFM31KC104R1H3	10	100000pF±20%	50	6
27	NFM31KC104R2A3	10	100000pF±20%	100	6
28	NFE31PT152Z1E9	10	1500pF+50/-20%	25	6
29	NFE31PT222Z1E9	10	2200pF±50%	25	6
30	NFE61PT102E1H9	10	1000pF+80/-20%	50	2
31	NFE61PT472C1H9	10	4700pF+80/-20%	50	2

Chip Ferrite Bead

Chip EMIFIL®
Design Kits

Chip Common Mode Choke Coil

Block Type EMIFIL®

Microwave Absorber

⚠Note • Please read rating and ⚠CAUTION (for storage, operating, rating, soldering, mounting and handling) in this catalog to prevent smoking and/or burning, etc.
• This catalog has only typical specifications. Therefore, please approve our product specifications or transact the approval sheet for product specifications before ordering.

Memo

DL□/PL□

Chip Common Mode Choke Coil
Large Current Common Mode Choke Coil for Automotive Available

Series Introduction	160
Part Numbering	162
Series Line Up	164
Product Detail	167
⚠Caution/Notice	192
Soldering and Mounting	194
Packaging	200
Design Kits	202

Chip Ferrite Bead

Chip EMIFIL®

Chip Common Mode Choke Coil

Block Type EMIFIL®

Microwave Absorber

⚠Note • Please read rating and ⚠CAUTION (for storage, operating, rating, soldering, mounting and handling) in this catalog to prevent smoking and/or burning, etc.
• This catalog has only typical specifications. Therefore, please approve our product specifications or transact the approval sheet for product specifications before ordering.

DL Series Introduction

Common Mode Current

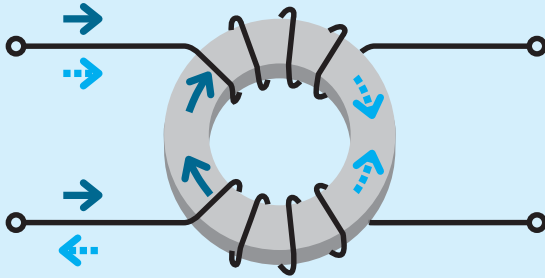

Differential Mode Current

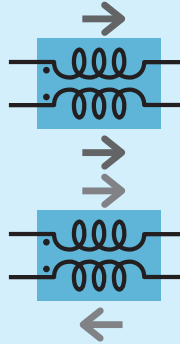

Magnetic flux caused by common mode current accumulates and works as an inductor.

Magnetic flux caused by differential mode current cancel each other and does not work as an inductor.

Category	Features, Classification	Structure	Part Number	Comments
High cut-off frequency High Coupling (For high speed differential signal lines)	Ultra high cut-off frequency for high speed differential signal lines	Film type	<ul style="list-style-type: none"> DLP0QSA DLP0NSA DLP11SA DLP11RB DLP11TB DLP2ADA 	<ul style="list-style-type: none"> · Low profile, small size, suitable for mobile equipment. · Tight terminal pitch enables high density layout. · Ultra high cut-off frequency and its matching to line impedance enables good transmission of high speed signal.
		Wound type	<ul style="list-style-type: none"> DLW21SN_HQ2 DLW21HN_HQ2 	<ul style="list-style-type: none"> · Ultra high self-resonance frequency enables high cut-off frequency. · Its matching to line impedance enables good transmission of high speed signal.
	High cut-off frequency for high speed differential signal lines	Multilayer type	<ul style="list-style-type: none"> DLM11SN 	<ul style="list-style-type: none"> · Enables noise suppression for differential signal line without distortion in high-speed signal transmission.
		Film type	<ul style="list-style-type: none"> DLP0QSN DLP0NS DLP11SN DLP11RN DLP2AD 	<ul style="list-style-type: none"> · Low profile, small size, suitable for mobile equipment. · Tight terminal pitch enables high density layout. · High cut-off frequency enables good transmission of high speed signal.
		Wound type	<ul style="list-style-type: none"> DLW21SN_SQ2 DLW31S DLW21HN_SQ2 	<ul style="list-style-type: none"> · Ultra high self-resonance frequency enables high cut-off frequency. · DLW21H is designed as low profile.
	For general differential signal lines	Film type	<ul style="list-style-type: none"> DLP31S DLP31D 	<ul style="list-style-type: none"> · Low profile, small size, suitable for mobile equipment. · Tight terminal pitch enables high density layout.
Large current High coupling (For power lines)		Wound type	<ul style="list-style-type: none"> DLW5AH DLW5BS DLW5AT DLW5BT 	<ul style="list-style-type: none"> · Large current (7A max.), suitable for input connector from an AC adaptor. · DLW5AT/DLW5BT is designed as low profile.
Relative high differential mode impedance Low coupling (For audio lines)		Multilayer type	<ul style="list-style-type: none"> DLM11G 	<ul style="list-style-type: none"> · Modified differential mode impedance is higher than other common mode choke coils; this feature makes it possible to suppress both common mode and differential mode noise. · Ideal to keep low distortion audio signal.
Large current Automotive Available (For power lines)	Available up to 18A	Winding type Cased structure	<ul style="list-style-type: none"> PLT10HH 	<ul style="list-style-type: none"> · Large current, high reliability, suitable for motors in automobiles.

△Note • Please read rating and △CAUTION (for storage, operating, rating, soldering, mounting and handling) in this catalog to prevent smoking and/or burning, etc.
• This catalog has only typical specifications. Therefore, please approve our product specifications or transact the approval sheet for product specifications before ordering.

Skew Improvement Effect of Common Mode Choke Coil

Example of Skew Improvement by Common Mode Choke Coil
(Tested using pulse generator waveform)

Waveform is equivalent to 1000Mbps signal

Waveform with intentionally made skew (skew: 100ps)

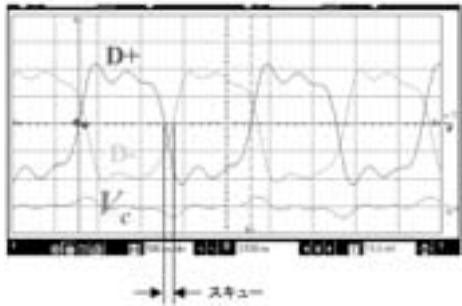

Skew is improved by common mode choke coil

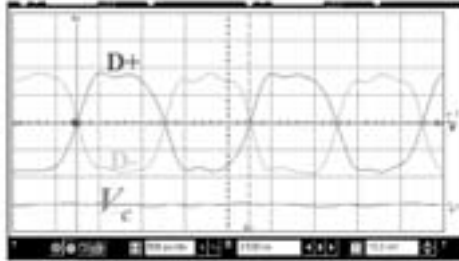

Mechanism of Skew Improvement

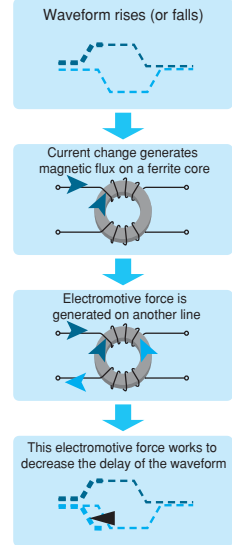

Noise Suppression of Common Mode Choke Coil in HDMI Line

Device under test / Transmitter : game machine

/ Receiver : projector

/ Cable : HDMI category 2 3m cable

Test resolution / 1080p Deep color 12bit (Data 1.1GHz) DVD play mode

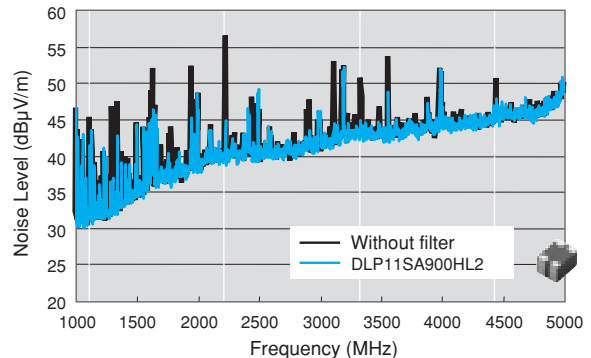
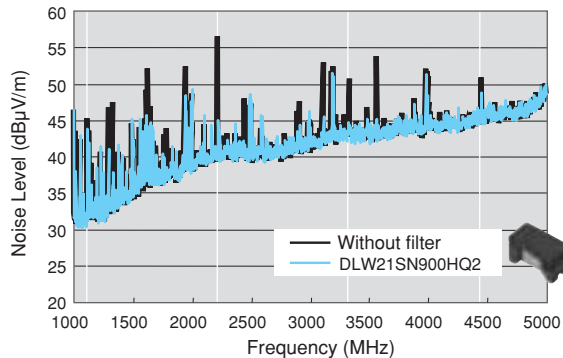

Test Example of HDMI1.3 Waveform Transmission

~Using ESD protection device

LXES15AAA1-100 (0.05pF)~

Signal frequency : 1.11GHz (Deep color 12bit)

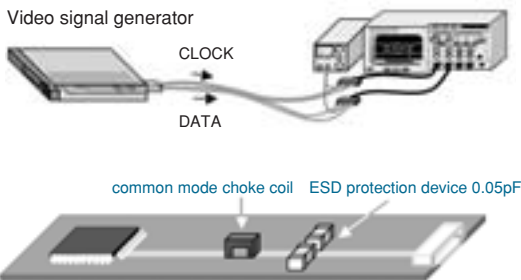

ESD protection device only

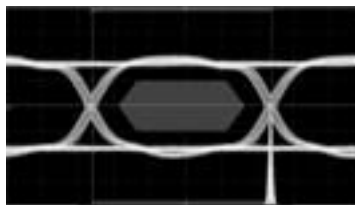

Film Type DLP11SN900HL2
(Cut-off frequency is lowest in the table below)

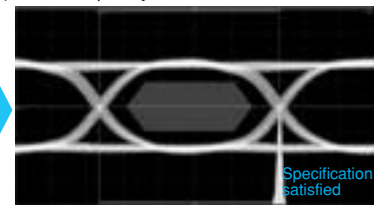

	Wound Type DLW21SN900HQ2	Film Type DLP11SA900HL2	Film Type Array DLP2ADN900HL4
Cut-off Frequency	Over 10GHz	Around 6GHz	Around 4GHz
Judge	Specification satisfied	Specification satisfied	Specification satisfied
Transition Time	Rise time: 83.4ps Fall time: 77.4ps	Rise time: 90.4ps Fall time: 85.5ps	Rise time: 100ps Fall time: 97.4ps

Each common mode choke coil can keep the waveform and satisfy the specification.

△Note • Please read rating and △CAUTION (for storage, operating, rating, soldering, mounting and handling) in this catalog to prevent smoking and/or burning, etc.
• This catalog has only typical specifications. Therefore, please approve our product specifications or transact the approval sheet for product specifications before ordering.

DL Chip Common Mode Choke Coil Part Numbering

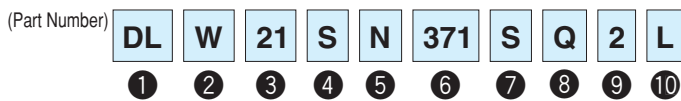

① Product ID

Product ID	
DL	Chip Common Mode Choke Coils

② Structure

Code	Structure
W	Wire Wound Type
M	Multilayer Type
P	Film Type

③ Dimensions (L×W)

Code	Dimensions (L×W)	EIA
0Q	0.65×0.5mm	025020
0N	0.85×0.65mm	03025
11	1.25×1.0mm	0504
1N	1.5×0.65mm	05025
21	2.0×1.2mm	0805
2A	2.0×1.0mm	0804
31	3.2×1.6mm	1206
5A	5.0×3.6mm	2014
5B	5.0×5.0mm	2020

④ Features (1)

Code	Type
S	Magnetically Shielded One Circuit Type
D	Magnetically Shielded Two Circuit Type
H	Open Magnetic One Circuit Type
G	Magnetically Shielded Audio Type
R/T	One Circuit Low Profile Type

⑤ Category

Code	Category
A	Expressed by a letter.
B	
C	
M	
N	
R	

⑥ Impedance

Typical impedance at 100MHz is expressed by three figures. The unit is in ohm (Ω). The first and second figures are significant digits, and the third figure expresses the number of zeros that follow the two figures.

⑦ Circuit

Code	Circuit
S	Expressed by a letter.
M	
H	
U	
T	

⑧ Features (2)

Code	Features
D	Expressed by a letter.
K	
L	
Q	
Y	

⑨ Number of Signal Lines

Code	Number of Signal Lines
2	Two Lines
4	Four Lines

⑩ Packaging

Code	Packaging	Series
K	Embossed Taping (ϕ 330mm Reel)	DLW5AH/DLW5BS/DLW5BT
L	Embossed Taping (ϕ 180mm Reel)	All Series
B	Bulk	All Series
D	Paper Taping (ϕ 180mm Reel)	DLP0QS/DLM11G

△Note • Please read rating and △CAUTION (for storage, operating, rating, soldering, mounting and handling) in this catalog to prevent smoking and/or burning, etc.
• This catalog has only typical specifications. Therefore, please approve our product specifications or transact the approval sheet for product specifications before ordering.



(Part Number)

PL	T	10H	H	102	6R0	P	N	B
①	②	③	④	⑤	⑥	⑦	⑧	⑨

① Product ID

Product ID	
PL	Common Mode Choke Coils

② Type

Code	Type
T	DC Type

③ Applications

Code	Applications
10H	for DC Line High-frequency Type

④ Features

Code	Features
H	for Automotive

⑨ Packaging

Code	Packaging	Series
B	Bulk	PLT10H
L	Embossed Taping (ø178mm/ø180mm Reel)	PLT10H
K	Embossed Taping (ø330mm Reel)	PLT10H

⑤ Impedance

Expressed by three figures. The unit is ohm (Ω). The first and second figures are significant digits, and the third figure expresses the number of zeros that follow the two figures.

⑥ Rated Current

Expressed by three figures. The unit is ampere (A). The first and second figures are significant digits, and the third figure expresses the number of zeros that follow the two figures. A decimal point is expressed by the capital letter "R." In this case, all figures are significant digits.

⑦ Winding Mode

Code	Winding Mode
P	Aligned Winding Type

⑧ Lead Dimensions

Code	Lead Dimensions
N	No Lead Terminal (SMD)

⚠Note • Please read rating and ⚠CAUTION (for storage, operating, rating, soldering, mounting and handling) in this catalog to prevent smoking and/or burning, etc.
• This catalog has only typical specifications. Therefore, please approve our product specifications or transact the approval sheet for product specifications before ordering.

Type	Size Code (Inch)	Thickness (mm)	Part Number	Common Mode Impedance (at 100MHz/20°C)	Rated Current	New	Kit	$\geq 1A$	Hd	$\geq 3A$	Ud	Zmatch	Flow	RefFlow	
Multilayer Type for Audio Lines	0504	<i>p174</i>	DLM11GN601SD2	600ohm±25%	100mA									RefFlow	
Multilayer Type for Differential Signal Lines	0504	<i>p175</i>	DLM11SN450HY2	45ohm±25%	100mA	New	Kit		Hd			Zmatch		RefFlow	
			DLM11SN900HY2	90ohm±25%	100mA	New	Kit		Hd			Zmatch		RefFlow	
Film Type for Differential Signal Lines	025020	<i>p176</i>	DLP0QSN600HL2	60ohm±25%	50mA		Kit		Hd			Zmatch		RefFlow	
			DLP0QSA070HL2	7ohm±2ohm	100mA	New	Kit		Ud			Zmatch		RefFlow	
			DLP0QSA150HL2	15ohm±5ohm	100mA	New	Kit		Ud			Zmatch		RefFlow	
			DLP0QSA350HL2	35ohm±10ohm	100mA	New	Kit		Ud			Zmatch		RefFlow	
		03025	<i>p177</i>	DLP0NSC280HL2	28ohm±20%	100mA		Kit		Hd			Zmatch		RefFlow
				DLP0NSN350HL2	35ohm±10ohm	100mA	New	Kit		Hd			Zmatch		RefFlow
			DLP0NSN670HL2	67ohm±20%	110mA		Kit		Hd			Zmatch		RefFlow	
			DLP0NSN900HL2	90ohm±20%	100mA		Kit		Hd			Zmatch		RefFlow	
			DLP0NSN121HL2	120ohm±20%	90mA		Kit		Hd			Zmatch		RefFlow	
			DLP0NSA070HL2	7ohm±2ohm	100mA	New	Kit		Ud			Zmatch		RefFlow	
		DLP0NSA150HL2	15ohm±5ohm	100mA		Kit		Ud			Zmatch		RefFlow		
	0504	<i>p179</i>	DLP11SN670SL2	67ohm±20%	180mA		Kit		Hd						RefFlow
			DLP11SN121SL2	120ohm±20%	140mA		Kit		Hd						RefFlow
			DLP11SN161SL2	160ohm±20%	120mA		Kit		Hd						RefFlow
			DLP11SN900HL2	90ohm±20%	150mA		Kit		Hd			Zmatch			RefFlow
			DLP11SN201HL2	200ohm±20%	110mA		Kit		Hd			Zmatch			RefFlow
			DLP11SN241HL2	240ohm±20%	100mA		Kit		Hd			Zmatch			RefFlow
			DLP11SN281HL2	280ohm±20%	90mA		Kit		Hd			Zmatch			RefFlow
		DLP11SN331HL2	330ohm±20%	80mA		Kit		Hd			Zmatch			RefFlow	
		DLP11SA350HL2	35ohm±20%	170mA		Kit		Ud			Zmatch			RefFlow	
		DLP11SA670HL2	67ohm±20%	150mA		Kit		Ud			Zmatch			RefFlow	
		DLP11SA900HL2	90ohm±20%	150mA		Kit		Ud			Zmatch			RefFlow	
0804		<i>p180</i>	DLP11RN450UL2	45ohm±25%	100mA		Kit		Hd			Zmatch			RefFlow
		DLP11RB150UL2	15ohm±5ohm	100mA		Kit		Hd			Zmatch			RefFlow	
		DLP11RB400UL2	40ohm±10ohm	100mA		Kit		Ud			Zmatch			RefFlow	
	<i>p181</i>	DLP11TB800UL2	80ohm±25%	100mA		Kit		Ud			Zmatch			RefFlow	
1206	<i>p182</i>	DLP31SN121ML2	120ohm±20%	100mA				Hd						RefFlow	
		DLP31SN221ML2	220ohm±20%	100mA				Hd						RefFlow	
		DLP31SN551ML2	550ohm±20%	100mA				Hd						RefFlow	
Film Array Type for Differential Signal Lines	05025	<i>p183</i>	DLP1NDN350HL4	35ohm±20%	100mA		Kit		Hd			Zmatch		RefFlow	
			DLP1NDN670HL4	67ohm±20%	80mA		Kit		Hd			Zmatch		RefFlow	
			DLP1NDN900HL4	90ohm±20%	60mA		Kit		Hd			Zmatch		RefFlow	
	0804	<i>p184</i>	DLP2ADA350HL4	35ohm±20%	150mA		Kit		Ud			Zmatch			RefFlow
			DLP2ADA670HL4	67ohm±20%	130mA		Kit		Ud			Zmatch			RefFlow
			DLP2ADA900HL4	90ohm±20%	120mA		Kit		Ud			Zmatch			RefFlow
			DLP2ADN670HL4	67ohm±20%	140mA		Kit		Hd			Zmatch			RefFlow
			DLP2ADN900HL4	90ohm±20%	130mA		Kit		Hd			Zmatch			RefFlow
			DLP2ADN121HL4	120ohm±20%	120mA		Kit		Hd			Zmatch			RefFlow
			DLP2ADN161HL4	160ohm±20%	100mA		Kit		Hd			Zmatch			RefFlow
			DLP2ADN201HL4	200ohm±20%	90mA		Kit		Hd			Zmatch			RefFlow
	1206	<i>p186</i>	DLP31DN900ML4	90ohm±20%	160mA				Hd						RefFlow
		DLP31DN131ML4	130ohm±20%	120mA				Hd						RefFlow	
		DLP31DN201ML4	200ohm±20%	100mA				Hd						RefFlow	
		DLP31DN321ML4	320ohm±20%	80mA				Hd						RefFlow	
		DLP31DN441ML4	440ohm±20%	70mA				Hd						RefFlow	

Continued on the following page.

△Note • Please read rating and △CAUTION (for storage, operating, rating, soldering, mounting and handling) in this catalog to prevent smoking and/or burning, etc.
 • This catalog has only typical specifications. Therefore, please approve our product specifications or transact the approval sheet for product specifications before ordering.

Chip Ferrite Bead

Chip EMIFIL®

Chip Common Mode Choke Coil

Block Type EMIFIL®

Microwave Absorber

Type	Size Code (Inch)	Thickness (mm)	Part Number	Common Mode Impedance (at 100MHz/20°C)	Rated Current	New	Kit	$\geq 1A$	Hd	$\geq 3A$	Ud	Z _{match}	F _{low}	R _{efFlow}					
Wire Wound Type for Differential Signal Lines	0805	p187	DLW21SN670SQ2	67ohm±25%	400mA		Kit		Hd					R _{efFlow}					
			DLW21SN900SQ2	90ohm±25%	330mA		Kit		Hd						R _{efFlow}				
			DLW21SN121SQ2	120ohm±25%	370mA		Kit		Hd							R _{efFlow}			
			DLW21SN181SQ2	180ohm±25%	330mA		Kit		Hd							R _{efFlow}			
			DLW21SN261SQ2	260ohm±25%	300mA		Kit		Hd							R _{efFlow}			
			DLW21SN371SQ2	370ohm±25%	280mA		Kit		Hd							R _{efFlow}			
			DLW21SN501SK2	500ohm±25%	250mA		Kit		Hd							R _{efFlow}			
			DLW21SN670HQ2	67ohm±25%	320mA		Kit		Ud	Z _{match}						R _{efFlow}			
			DLW21SN900HQ2	90ohm±25%	280mA		Kit		Ud	Z _{match}						R _{efFlow}			
			DLW21SN121HQ2	120ohm±25%	280mA		Kit		Ud	Z _{match}						R _{efFlow}			
			DLW21SR670HQ2	67ohm±25%	400mA		Kit		Ud	Z _{match}						R _{efFlow}			
			1206	p189	p189	DLW21HN670SQ2	67ohm±25%	330mA		Kit		Hd					R _{efFlow}		
	DLW21HN900SQ2	90ohm±25%				330mA		Kit		Hd						R _{efFlow}			
	DLW21HN121SQ2	120ohm±25%				280mA		Kit		Hd						R _{efFlow}			
	DLW21HN181SQ2	180ohm±25%				250mA		Kit		Hd							R _{efFlow}		
	DLW21HN670HQ2	67ohm±25%				240mA		New	Kit		Ud	Z _{match}					R _{efFlow}		
	DLW21HN900HQ2	90ohm±25%				220mA		New	Kit		Ud	Z _{match}					R _{efFlow}		
	DLW21HN121HQ2	120ohm±25%				200mA		New	Kit		Ud	Z _{match}					R _{efFlow}		
	1206	p190				p190	DLW31SN900SQ2	90ohm±25%	370mA				Hd					R _{efFlow}	
							DLW31SN161SQ2	160ohm±25%	340mA				Hd						R _{efFlow}
							DLW31SN261SQ2	260ohm±25%	310mA				Hd						R _{efFlow}
							DLW31SN601SQ2	600ohm±25%	260mA				Hd						R _{efFlow}
							DLW31SN102SQ2	1000ohm±25%	230mA				Hd						R _{efFlow}
			DLW31SN222SQ2	2200ohm±25%	200mA					Hd						R _{efFlow}			
Wire Wound Type for Power Lines and Signal Lines	2014	p167	DLW5AHN402SQ2	4000ohm (Typ.)	200mA		Kit							R _{efFlow}					
			p169	DLW5ATN111SQ2	110ohm (Typ.)	5000mA		Kit		$\geq 3A$						R _{efFlow}			
				DLW5ATN401SQ2	400ohm (Typ.)	2000mA		Kit		$\geq 1A$						R _{efFlow}			
				DLW5ATN501SQ2	500ohm (Typ.)	1500mA		Kit		$\geq 1A$						R _{efFlow}			
				DLW5ATN851SQ2	850ohm (Typ.)	1500mA		Kit		$\geq 1A$						R _{efFlow}			
				DLW5ATN272SQ2	2700ohm (Typ.)	1000mA		Kit		$\geq 1A$						R _{efFlow}			
				p172	DLW5ATN500MQ2	50ohm (Typ.)	6000mA		New	Kit	$\geq 3A$			F _{low}			R _{efFlow}		
			DLW5ATN151MQ2		150ohm (Typ.)	5000mA		New	Kit	$\geq 3A$			F _{low}			R _{efFlow}			
			DLW5ATN331MQ2		330ohm (Typ.)	4000mA		New	Kit	$\geq 3A$			F _{low}			R _{efFlow}			
			DLW5ATN112MQ2		1100ohm (Typ.)	2000mA		New	Kit	$\geq 1A$			F _{low}			R _{efFlow}			
			DLW5ATN450TQ2		45ohm (Typ.)	7000mA		New	Kit	$\geq 3A$						R _{efFlow}			
			DLW5ATN111TQ2		100ohm (Typ.)	5000mA		New	Kit	$\geq 3A$						R _{efFlow}			
	2020	p167	p167	DLW5ATN231TQ2	230ohm (Typ.)	4000mA		New	Kit	$\geq 3A$					R _{efFlow}				
				DLW5ATN501TQ2	500ohm (Typ.)	2000mA		New	Kit	$\geq 1A$						R _{efFlow}			
				p169	DLW5BSM191SQ2	190ohm (Typ.)	5000mA		Kit		$\geq 3A$						R _{efFlow}		
					DLW5BSM351SQ2	350ohm (Typ.)	2000mA		Kit		$\geq 1A$						R _{efFlow}		
					DLW5BSM102SQ2	1000ohm (Typ.)	1500mA		Kit		$\geq 1A$						R _{efFlow}		
					DLW5BSM152SQ2	1500ohm (Typ.)	1000mA		Kit		$\geq 1A$						R _{efFlow}		
		DLW5BSM302SQ2	3000ohm (Typ.)		500mA		Kit								R _{efFlow}				
		p172	DLW5BTM101SQ2		100ohm (Typ.)	6000mA		Kit		$\geq 3A$						R _{efFlow}			
			DLW5BTM251SQ2	250ohm (Typ.)	5000mA		Kit		$\geq 3A$						R _{efFlow}				
			DLW5BTM501SQ2	500ohm (Typ.)	4000mA		Kit		$\geq 3A$						R _{efFlow}				
			DLW5BTM102SQ2	1000ohm (Typ.)	2000mA		Kit		$\geq 1A$						R _{efFlow}				
			DLW5BTM142SQ2	1400ohm (Typ.)	1500mA		Kit		$\geq 1A$						R _{efFlow}				
DLW5BTM101TQ2	100ohm (Typ.)		6000mA		New	Kit	$\geq 3A$						R _{efFlow}						
2020	p172	p172	DLW5BTM251TQ2	250ohm (Typ.)	5000mA		New	Kit	$\geq 3A$					R _{efFlow}					
			DLW5BTM501TQ2	500ohm (Typ.)	4000mA		New	Kit	$\geq 3A$					R _{efFlow}					
			DLW5BTM142TQ2	1400ohm (Typ.)	2000mA		New	Kit	$\geq 1A$						R _{efFlow}				

Chip Ferrite Bead

Chip EMIFIL®

Chip Common Mode Choke Coil

Block Type EMIFIL®

Microwave Absorber

△Note • Please read rating and △CAUTION (for storage, operating, rating, soldering, mounting and handling) in this catalog to prevent smoking and/or burning, etc.
 • This catalog has only typical specifications. Therefore, please approve our product specifications or transact the approval sheet for product specifications before ordering.

Type	Size	Thickness (mm)	Part Number	Common Mode Impedance (at 10MHz/20°C)	Rated Current	New	Kit	≥3A	Hd	≥10A	Ud	Z _{match}	F _{low}	R _{eFlow}
Large Current Common Mode Choke Coil for Automotive Available	12.9x6.6 (mm)	9.4	PLT10HH450180PN	45ohm (Typ.)	18A	New	Kit	≥10A						R _{eFlow}
		9.4	PLT10HH101150PN	100ohm (Typ.)	15A	New	Kit	≥10A						R _{eFlow}
		9.4	PLT10HH401100PN	400ohm (Typ.)	10A		Kit	≥10A						R _{eFlow}
		9.4	PLT10HH501100PN	500ohm (Typ.)	10A		Kit	≥10A						R _{eFlow}
		9.4	PLT10HH9016R0PN	900ohm (Typ.)	6A		Kit	≥3A						R _{eFlow}
		9.4	PLT10HH1026R0PN	1000ohm (Typ.)	6A		Kit	≥3A						R _{eFlow}

Chip Ferrite Bead

Chip EMIFIL®

Chip Common Mode Choke Coil

Block Type EMIFIL®

Microwave Absorber

△Note • Please read rating and △CAUTION (for storage, operating, rating, soldering, mounting and handling) in this catalog to prevent smoking and/or burning, etc.
 • This catalog has only typical specifications. Therefore, please approve our product specifications or transact the approval sheet for product specifications before ordering.

DLW5AH/DLW5BS Series (2014/2020 Size)



5A max, common mode choke coil for power lines.

DLW5AH



■ Dimensions

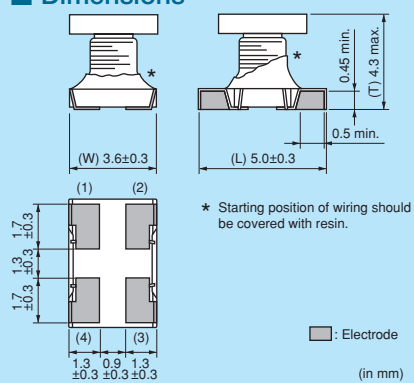

* Starting position of wiring should be covered with resin.

Legend: Electrode (in mm)

■ Equivalent Circuit

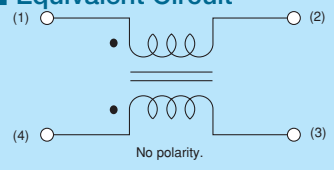

■ Packaging

Code	Packaging	Minimum Quantity
L	180mm Reel Embossed Tape	400
K	330mm Reel Embossed Tape	1500
B	Bulk(Bag)	100

DLW5BS



■ Dimensions

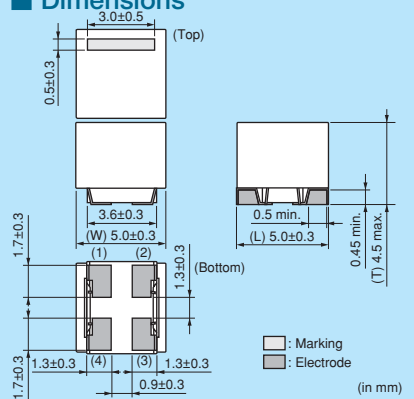

Legend: Marking Electrode (in mm)

■ Equivalent Circuit

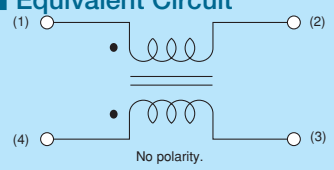

■ Packaging

Code	Packaging	Minimum Quantity
L	180mm Reel Embossed Tape	400
K	330mm Reel Embossed Tape	1500
B	Bulk(Bag)	100

Refer to pages from p.194 to p.197 for mounting information.

■ Rated Value (□: packaging code)

Part Number	Common Mode Impedance (at 100MHz/20°C)	Rated Current	Rated Voltage	Insulation Resistance (min.)	Withstand Voltage	DC Resistance	
DLW5AHN402SQ2□	4000ohm (Typ.)	200mA	50Vdc	10M ohm	125Vdc	3.0ohm max.	Kit
DLW5BSM191SQ2□	190ohm (Typ.)	5000mA	50Vdc	10M ohm	125Vdc	0.02ohm max.	Kit ≥3A
DLW5BSM351SQ2□	350ohm (Typ.)	2000mA	50Vdc	10M ohm	125Vdc	0.04ohm max.	Kit ≥1A
DLW5BSM102SQ2□	1000ohm (Typ.)	1500mA	50Vdc	10M ohm	125Vdc	0.06ohm max.	Kit ≥1A
DLW5BSM152SQ2□	1500ohm (Typ.)	1000mA	50Vdc	10M ohm	125Vdc	0.1ohm max.	Kit ≥1A
DLW5BSM302SQ2□	3000ohm (Typ.)	500mA	50Vdc	10M ohm	125Vdc	0.3ohm max.	Kit

Operating Temperature Range: -25°C to +85°C (DLW5AH), -40°C to +85°C (DLW5BS) Number of Circuit: 1

■ Impedance-Frequency Characteristics

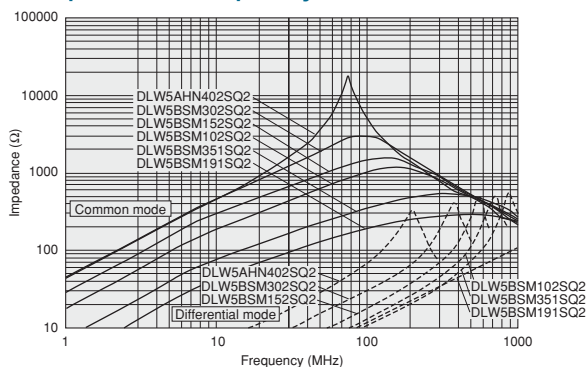

Continued on the following page.

△Note • Please read rating and △CAUTION (for storage, operating, rating, soldering, mounting and handling) in this catalog to prevent smoking and/or burning, etc.
• This catalog has only typical specifications. Therefore, please approve our product specifications or transact the approval sheet for product specifications before ordering.

Notice (Rating)

In operating temperature exceeding +75°C, derating of current is necessary for DLW5BSM191SQ2 series.

Please apply the derating curve shown in chart according to the operating temperature.

Derating of Rated Current

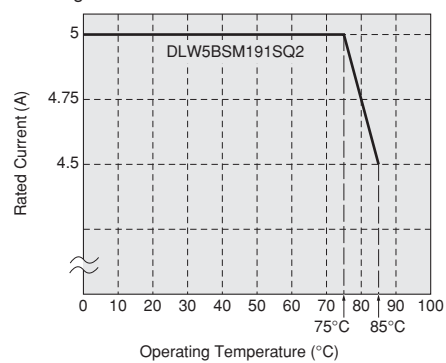

⚠Note • Please read rating and ⚠CAUTION (for storage, operating, rating, soldering, mounting and handling) in this catalog to prevent smoking and/or burning, etc.
• This catalog has only typical specifications. Therefore, please approve our product specifications or transact the approval sheet for product specifications before ordering.

Chip Ferrite Bead

Chip EMIFIL®

Chip Common Mode Choke Coil
Universal Type [Power Lines/Signal Lines]

Block Type EMIFIL®

Microwave Absorber

DLW5AT/DLW5BT Series (2014/2020 Size)



Low profile wire-wound common choke coil for power lines.

DLW5AT

■ Dimensions

■ Electrode
(in mm)

■ Equivalent Circuit

No polarity.

■ Packaging

Code	Packaging	Minimum Quantity
L	180mm Reel Embossed Tape	700
K	330mm Reel Embossed Tape	2500
B	Bulk(Bag)	100

DLW5BT

■ Dimensions

■ Marking
■ Electrode
(in mm)

■ Equivalent Circuit

No polarity.

■ Packaging

Code	Packaging	Minimum Quantity
L	180mm Reel Embossed Tape	700
K	330mm Reel Embossed Tape	2500
B	Bulk(Bag)	100

Refer to pages from p.194 to p.197 for mounting information.

■ Rated Value (□: packaging code)

Part Number	Common Mode Impedance (at 100MHz/20°C)	Rated Current	Rated Voltage	Insulation Resistance (min.)	Withstand Voltage	DC Resistance	
DLW5ATN111SQ2□	110ohm (Typ.)	5000mA	50Vdc	10M ohm	125Vdc	0.014ohm±40%	Kit ≥3A
DLW5ATN401SQ2□	400ohm (Typ.)	2000mA	50Vdc	10M ohm	125Vdc	0.024ohm±40%	Kit ≥1A
DLW5ATN501SQ2□	500ohm (Typ.)	1500mA	50Vdc	10M ohm	125Vdc	0.040ohm±40%	Kit ≥1A
DLW5ATN851SQ2□	850ohm (Typ.)	1500mA	50Vdc	10M ohm	125Vdc	0.052ohm±40%	Kit ≥1A
DLW5ATN272SQ2□	2700ohm (Typ.)	1000mA	50Vdc	10M ohm	125Vdc	0.080ohm±40%	Kit ≥1A
DLW5BTM101SQ2□	100ohm (Typ.)	6000mA	50Vdc	10M ohm	125Vdc	0.009ohm±40%	Kit ≥3A
DLW5BTM251SQ2□	250ohm (Typ.)	5000mA	50Vdc	10M ohm	125Vdc	0.014ohm±40%	Kit ≥3A
DLW5BTM501SQ2□	500ohm (Typ.)	4000mA	50Vdc	10M ohm	125Vdc	0.019ohm±40%	Kit ≥3A
DLW5BTM102SQ2□	1000ohm (Typ.)	2000mA	50Vdc	10M ohm	125Vdc	0.024ohm±40%	Kit ≥1A
DLW5BTM142SQ2□	1400ohm (Typ.)	1500mA	50Vdc	10M ohm	125Vdc	0.040ohm±40%	Kit ≥1A

Operating Temperature Range: -40°C to +85°C Number of Circuit: 1

Continued on the following page.

△Note • Please read rating and △CAUTION (for storage, operating, rating, soldering, mounting and handling) in this catalog to prevent smoking and/or burning, etc.
• This catalog has only typical specifications. Therefore, please approve our product specifications or transact the approval sheet for product specifications before ordering.

Impedance-Frequency Characteristics
DLW5AT Series

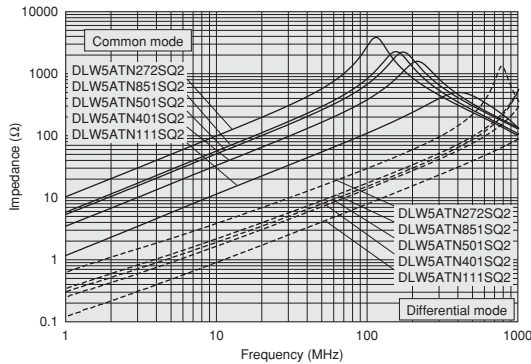

DLW5BT Series

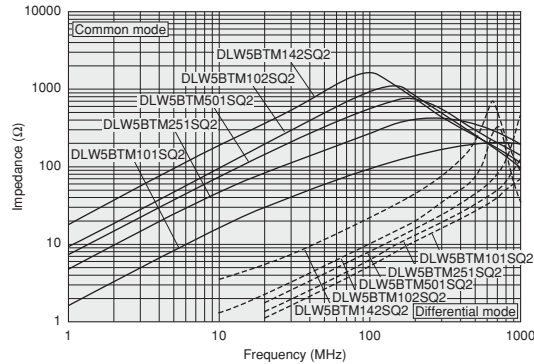

Notice (Rating)

In operating temperature exceeding +60°C, derating of current is necessary for DLW5AT series. Please apply the derating curve shown in chart according to the operating temperature.

Derating of Rated Current

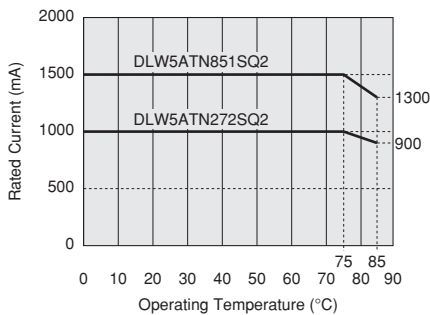
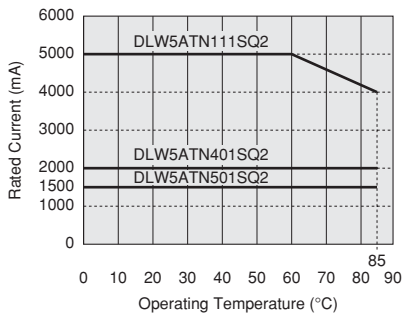

In operating temperature exceeding +60°C, derating of current is necessary for the following part name of DLW5BT series. Please apply the derating curve shown in chart according to the operating temperature.

Derating of Rated Current

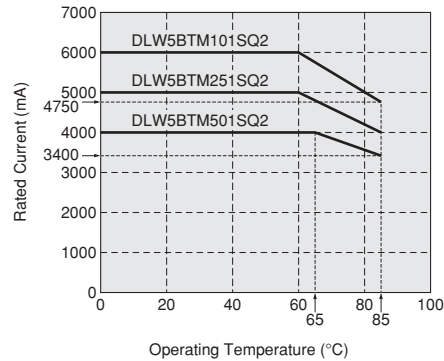

△Note • Please read rating and △CAUTION (for storage, operating, rating, soldering, mounting and handling) in this catalog to prevent smoking and/or burning, etc.
• This catalog has only typical specifications. Therefore, please approve our product specifications or transact the approval sheet for product specifications before ordering.

DLW5AT/DLW5BT Series (105degreeC available type)



Low profile wire-wound common choke coil for power lines. (105degreeC available type)

DLW5AT_MQ2



■ Dimensions

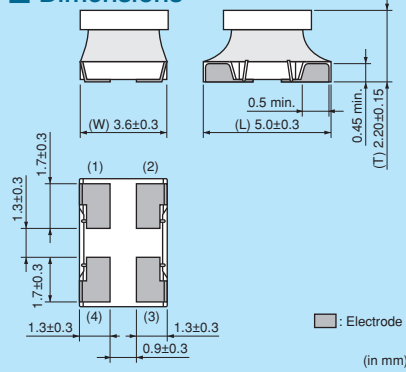

■ Equivalent Circuit

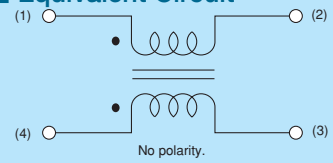

■ Packaging

Code	Packaging	Minimum Quantity
L	180mm Reel Embossed Tape	700
K	330mm Reel Embossed Tape	2500
B	Bulk(Bag)	100

DLW5AT_TQ2



■ Dimensions

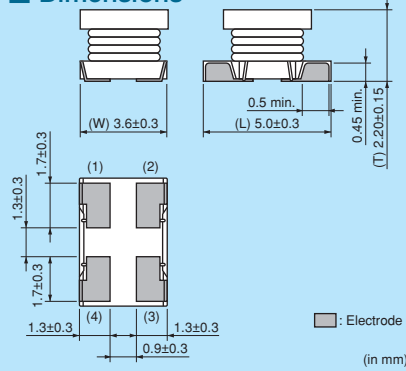

■ Equivalent Circuit

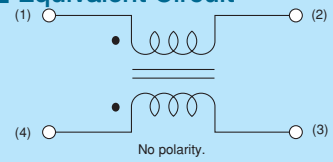

■ Packaging

Code	Packaging	Minimum Quantity
L	180mm Reel Embossed Tape	700
K	330mm Reel Embossed Tape	2500
B	Bulk(Bag)	100

DLW5BT_TQ2



■ Dimensions

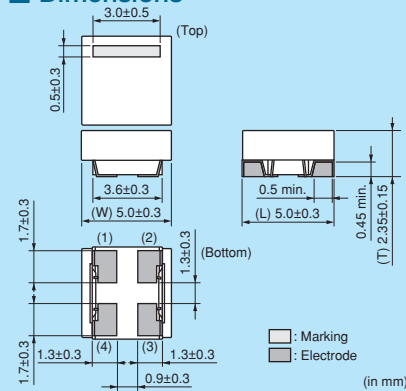

■ Equivalent Circuit

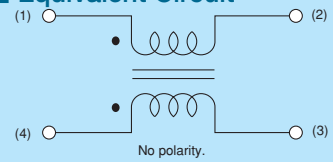

■ Packaging

Code	Packaging	Minimum Quantity
L	180mm Reel Embossed Tape	700
K	330mm Reel Embossed Tape	2500
B	Bulk(Bag)	100

Refer to pages from p.194 to p.197 for mounting information.

Continued on the following page.

△Note • Please read rating and △CAUTION (for storage, operating, rating, soldering, mounting and handling) in this catalog to prevent smoking and/or burning, etc.
 • This catalog has only typical specifications. Therefore, please approve our product specifications or transact the approval sheet for product specifications before ordering.

Rated Value (□: packaging code)

Part Number	Common Mode Impedance (at 100MHz/20°C)	Rated Current	Rated Voltage	Insulation Resistance (min.)	Withstand Voltage	DC Resistance					
DLW5ATN500MQ2□	50ohm (Typ.)	6000mA	50Vdc	10M ohm	125Vdc	0.009ohm±40%	New	Kit	≥3A	Flow	ReFlow
DLW5ATN151MQ2□	150ohm (Typ.)	5000mA	50Vdc	10M ohm	125Vdc	0.014ohm±40%	New	Kit	≥3A	Flow	ReFlow
DLW5ATN331MQ2□	330ohm (Typ.)	4000mA	50Vdc	10M ohm	125Vdc	0.019ohm±40%	New	Kit	≥3A	Flow	ReFlow
DLW5ATN112MQ2□	1100ohm (Typ.)	2000mA	50Vdc	10M ohm	125Vdc	0.040ohm±40%	New	Kit	≥1A	Flow	ReFlow
DLW5ATN450TQ2□	45ohm (Typ.)	7000mA	50Vdc	10M ohm	125Vdc	0.006ohm±40%	New	Kit	≥3A		ReFlow
DLW5ATN111TQ2□	110ohm (Typ.)	5000mA	50Vdc	10M ohm	125Vdc	0.014ohm±40%	New	Kit	≥3A		ReFlow
DLW5ATN231TQ2□	230ohm (Typ.)	4000mA	50Vdc	10M ohm	125Vdc	0.019ohm±40%	New	Kit	≥3A		ReFlow
DLW5ATN501TQ2□	500ohm (Typ.)	2000mA	50Vdc	10M ohm	125Vdc	0.040ohm±40%	New	Kit	≥1A		ReFlow
DLW5BTM101TQ2□	100ohm (Typ.)	6000mA	50Vdc	10M ohm	125Vdc	0.009ohm±40%	New	Kit	≥3A		ReFlow
DLW5BTM251TQ2□	250ohm (Typ.)	5000mA	50Vdc	10M ohm	125Vdc	0.014ohm±40%	New	Kit	≥3A		ReFlow
DLW5BTM501TQ2□	500ohm (Typ.)	4000mA	50Vdc	10M ohm	125Vdc	0.019ohm±40%	New	Kit	≥3A		ReFlow
DLW5BTM142TQ2□	1400ohm (Typ.)	2000mA	50Vdc	10M ohm	125Vdc	0.040ohm±40%	New	Kit	≥1A		ReFlow

Operating Temperature Range: -40°C to +85°C Number of Circuit: 1

Impedance-Frequency Characteristics
DLW5AT_MQ2 Series

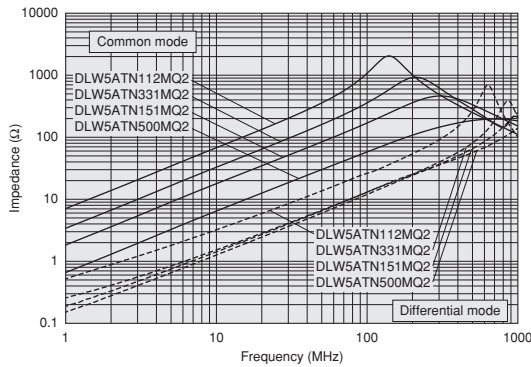

DLW5AT_TQ2 Series

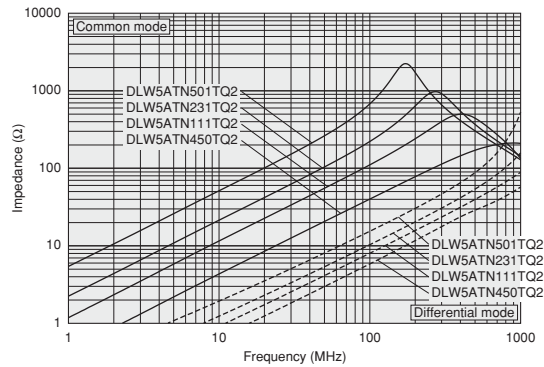

DLW5BT_TQ2 Series

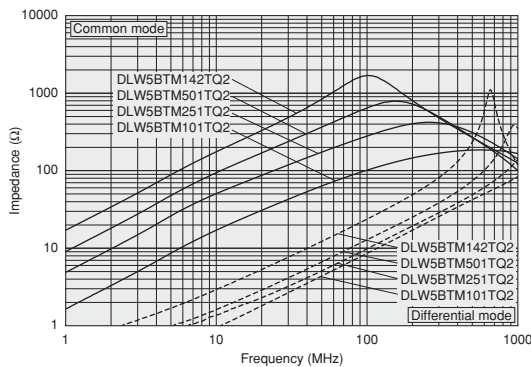

Continued on the following page.

Note • Please read rating and CAUTION (for storage, operating, rating, soldering, mounting and handling) in this catalog to prevent smoking and/or burning, etc.
• This catalog has only typical specifications. Therefore, please approve our product specifications or transact the approval sheet for product specifications before ordering.

Chip Ferrite Bead

Chip EMIFIL®

Chip Common Mode Choke Coil
Universal Type [Power Lines/Signal Lines]

Block Type EMIFIL®

Microwave Absorber

Notice (Rating)

In operating temperature exceeding +85°C, derating of current is necessary for DLW5AT series (105 degree C available type). Please apply the derating curve shown in chart according to the operating temperature.

In operating temperature exceeding +85°C, derating of current is necessary for DLW5AT series (105 degree C available type). Please apply the derating curve shown in chart according to the operating temperature.

Derating of Rated Current

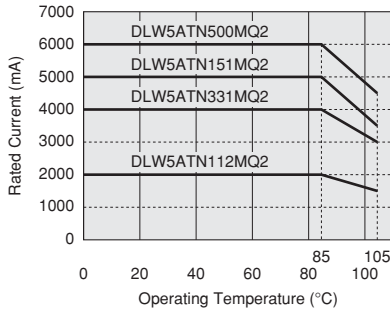

Derating of Rated Current

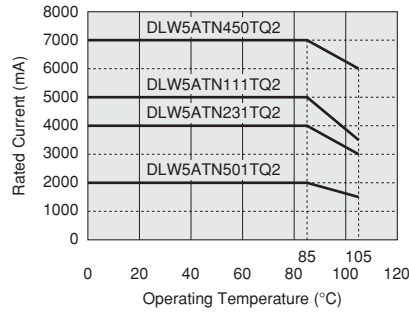

In operating temperature exceeding +85°C, derating of current is necessary for DLW5BT series (105 degree C available type). Please apply the derating curve shown in chart according to the operating temperature.

Derating of Rated Current

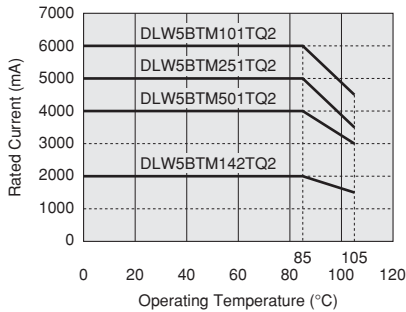

⚠Note • Please read rating and ⚠CAUTION (for storage, operating, rating, soldering, mounting and handling) in this catalog to prevent smoking and/or burning, etc.
• This catalog has only typical specifications. Therefore, please approve our product specifications or transact the approval sheet for product specifications before ordering.

DLM11G Series (0504 Size)



Audio line common choke also effective to differential mode.

■ Dimensions

(in mm)

■ Equivalent Circuit

No polarity.

■ Packaging

Code	Packaging	Minimum Quantity
D	180mm Reel Paper Tape	10000
B	Bulk(Bag)	1000

Refer to pages from p.194 to p.197 for mounting information.

■ Rated Value (□: packaging code)

Part Number	Common Mode Impedance (at 100MHz/20°C)	Rated Current	Rated Voltage	Insulation Resistance (min.)	Withstand Voltage	DC Resistance	Operating Temperature Range
DLM11GN601SD2□	600ohm ±25%	100mA	5Vdc	100M ohm	25Vdc	0.8ohm max.	-40°C to +85°C

Number of Circuit: 1

■ Impedance-Frequency Characteristics

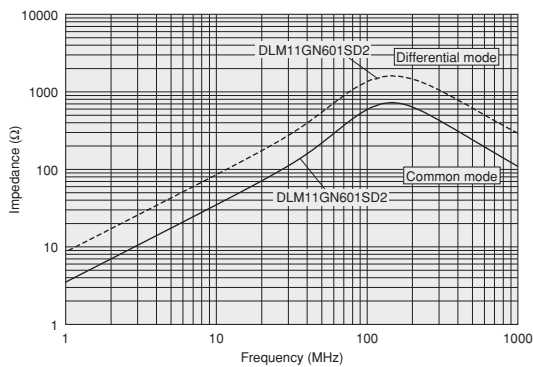

⚠Note • Please read rating and ⚠CAUTION (for storage, operating, rating, soldering, mounting and handling) in this catalog to prevent smoking and/or burning, etc.
 • This catalog has only typical specifications. Therefore, please approve our product specifications or transact the approval sheet for product specifications before ordering.

Chip Ferrite Bead

Chip EMIFIL®

Chip Common Mode Choke Coil
Signal Lines Type

Block Type EMIFIL®

Microwave Absorber

DLM11S Series (0504 Size)



0504 size multilayer type chip common mode choke coil.

■ Dimensions

(in mm)

■ Equivalent Circuit

No polarity.

■ Packaging

Code	Packaging	Minimum Quantity
L	180mm Reel Embossed Tape	4000
B	Bulk(Bag)	500

Refer to pages from p.194 to p.197 for mounting information.

■ Rated Value (□: packaging code)

Part Number	Common Mode Impedance (at 100MHz/20°C)	Rated Current	Rated Voltage	Insulation Resistance (min.)	Withstand Voltage	DC Resistance	
DLM11SN450HY2□	45ohm ±25%	100mA	5Vdc	100M ohm	12.5Vdc	0.7ohm±25%	New Kit HD LMP
DLM11SN900HY2□	90ohm ±25%	100mA	5Vdc	100M ohm	12.5Vdc	1.1ohm±25%	New Kit HD LMP

Operating Temperature Range: -40°C to +85°C Number of Circuit: 1

■ Impedance-Frequency Characteristics

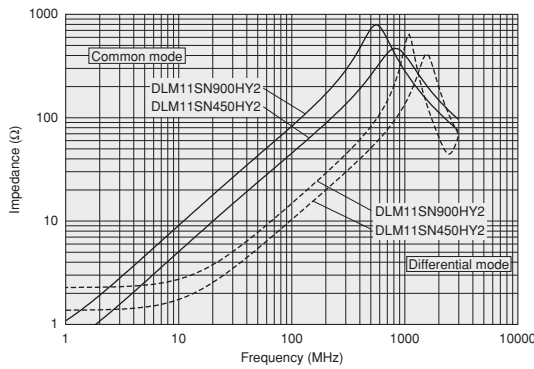

■ Differential Mode Transmission Characteristics (Typ.)

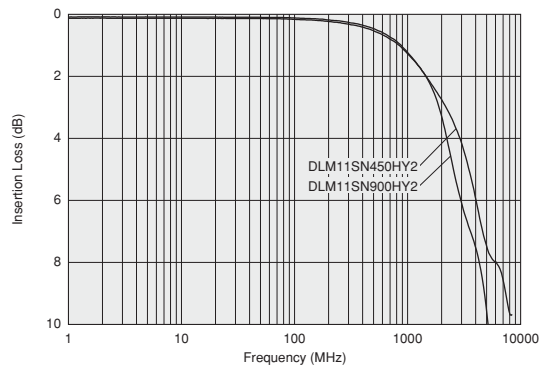

⚠Note • Please read rating and ⚠CAUTION (for storage, operating, rating, soldering, mounting and handling) in this catalog to prevent smoking and/or burning, etc.
• This catalog has only typical specifications. Therefore, please approve our product specifications or transact the approval sheet for product specifications before ordering.

DLPOQS Series (025020 Size)



025020 size, very small chip common mode choke coil, Cut-off frequency 8GHz max. Some of them are ready for DisplayPort or SATA.

■ Dimensions

(in mm)

■ Equivalent Circuit

No polarity.

■ Packaging

Code	Packaging	Minimum Quantity
D	180mm Reel Paper Tape	15000
B	Bulk(Bag)	500

Refer to pages from p.194 to p.197 for mounting information.

■ Rated Value (□: packaging code)

Part Number	Common Mode Impedance (at 100MHz/20°C)	Rated Current	Rated Voltage	Insulation Resistance (min.)	Withstand Voltage	DC Resistance	
DLPOQSN600HL2□	60ohm ±25%	50mA	5Vdc	100M ohm	12.5Vdc	3.8ohm±25%	Kit HD
DLPOQSA070HL2□	7ohm ±2ohm	100mA	5Vdc	100M ohm	12.5Vdc	0.7ohm±25%	New Kit
DLPOQSA150HL2□	15ohm ±5ohm	100mA	5Vdc	100M ohm	12.5Vdc	0.8ohm±25%	New Kit
DLPOQSA350HL2□	35ohm ±10ohm	100mA	5Vdc	100M ohm	12.5Vdc	2.2ohm±25%	New Kit

Operating Temperature Range: -40°C to +85°C Number of Circuit: 1

HD: for high speed differential signal lines UD: for ultra high speed differential signal lines

■ Impedance-Frequency Characteristics

DLPOQSN Series

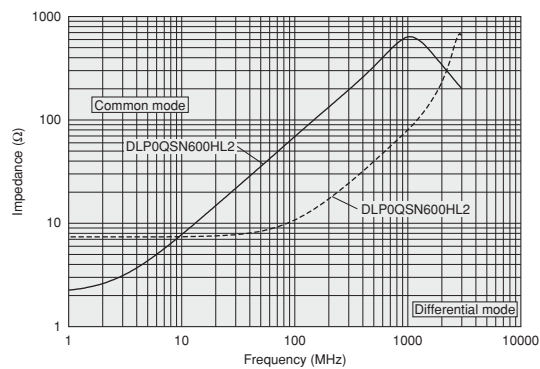

DLPOQSA Series

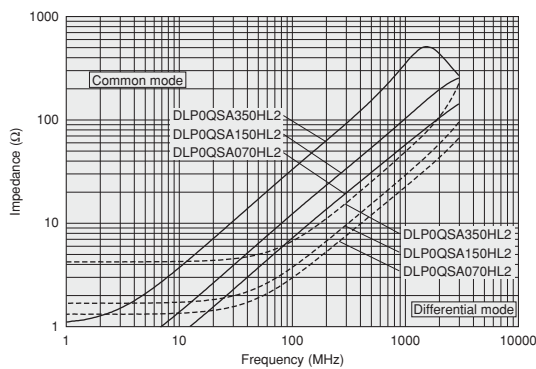

■ Differential Mode Transmission Characteristics (Typ.)

DLPOQSN Series

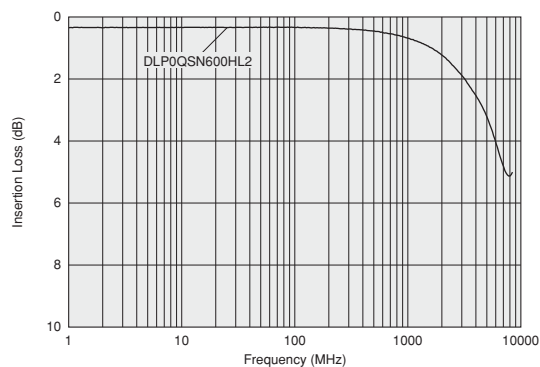

DLPOQSA Series

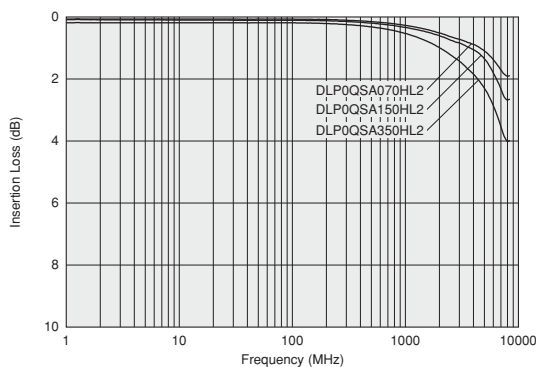

△Note • Please read rating and △CAUTION (for storage, operating, rating, soldering, mounting and handling) in this catalog to prevent smoking and/or burning, etc.
• This catalog has only typical specifications. Therefore, please approve our product specifications or transact the approval sheet for product specifications before ordering.

Chip Ferrite Bead

Chip EMIFIL®

Chip Common Mode Choke Coil
Signal Lines Type

Block Type EMIFIL®

Microwave Absorber

DLP0NS Series (03025 Size)



03025 size, very small chip common mode choke coil, Cut-off frequency 8GHz max. Some of them are ready for mipi, DisplayPort or SATA.

■ Dimensions

(in mm)

■ Equivalent Circuit

■ Packaging

Code	Packaging	Minimum Quantity
L	180mm Reel Embossed Tape	10000
B	Bulk(Bag)	500

Refer to pages from p.194 to p.197 for mounting information.

■ Rated Value (□: packaging code)

Part Number	Common Mode Impedance (at 100MHz/20°C)	Rated Current	Rated Voltage	Insulation Resistance (min.)	Withstand Voltage	DC Resistance	
DLP0NSC280HL2□	28ohm ±20%	100mA	5Vdc	100M ohm	12.5Vdc	1.3ohm±25%	Kit HD
DLP0NSN350HL2□	35ohm ±10ohm	100mA	5Vdc	100M ohm	12.5Vdc	1.2ohm±25%	New Kit HD
DLP0NSN670HL2□	67ohm ±20%	110mA	5Vdc	100M ohm	12.5Vdc	2.4ohm±25%	Kit HD
DLP0NSN900HL2□	90ohm ±20%	100mA	5Vdc	100M ohm	12.5Vdc	3.0ohm±25%	Kit HD
DLP0NSN121HL2□	120ohm ±20%	90mA	5Vdc	100M ohm	12.5Vdc	3.8ohm±25%	Kit HD
DLP0NSA070HL2□	7ohm ±2ohm	100mA	5Vdc	100M ohm	12.5Vdc	0.6ohm±25%	New Kit
DLP0NSA150HL2□	15ohm ±5ohm	100mA	5Vdc	100M ohm	12.5Vdc	0.95ohm±25%	Kit

Operating Temperature Range: -40°C to +85°C Number of Circuit: 1

HD: for high speed differential signal lines UD: for ultra high speed differential signal lines

■ Impedance-Frequency Characteristics DLP0NSC/DLP0NSN Series

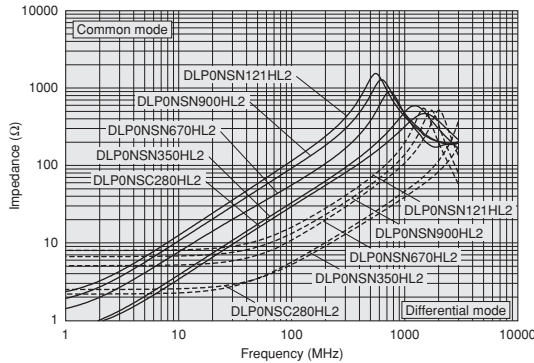

DLP0NSA Series

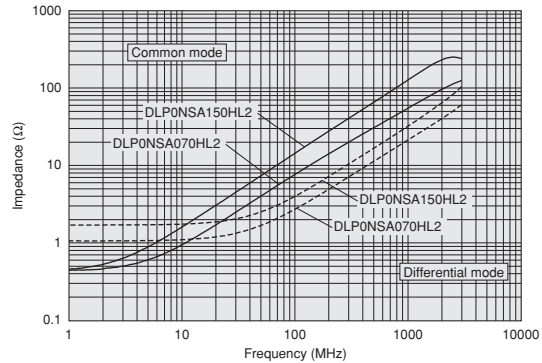

Continued on the following page.

△Note • Please read rating and △CAUTION (for storage, operating, rating, soldering, mounting and handling) in this catalog to prevent smoking and/or burning, etc.
• This catalog has only typical specifications. Therefore, please approve our product specifications or transact the approval sheet for product specifications before ordering.

■ Differential Mode Transmission Characteristics (Typ.)

DLP0NSC/DLP0NSN Series

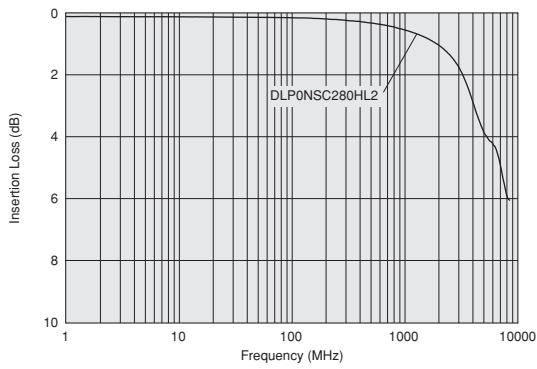

DLP0NSN Series

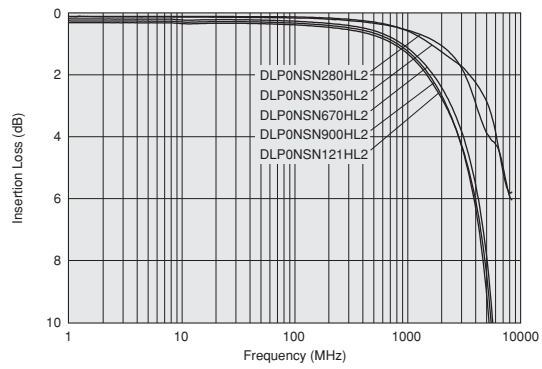

DLP0NSA Series

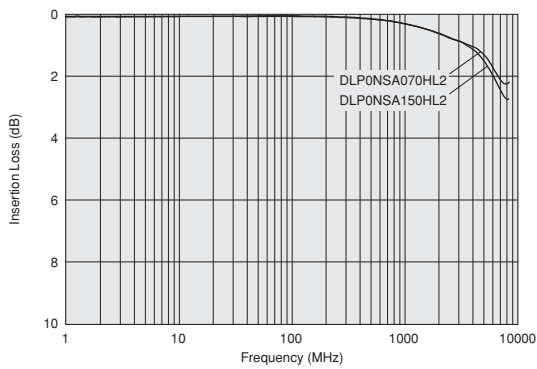

⚠Note • Please read rating and ⚠CAUTION (for storage, operating, rating, soldering, mounting and handling) in this catalog to prevent smoking and/or burning, etc.
 • This catalog has only typical specifications. Therefore, please approve our product specifications or transact the approval sheet for product specifications before ordering.

Chip Ferrite Bead

Chip EMIFIL®

Chip Common Mode Choke Coil
 Signal Lines Type

Block Type EMIFIL®

Microwave Absorber

DLP11S/DLP11R/DLP11T Series (0504 Size)



8GHz cut-off frequency (for HDMI/USB 3.0) is available.

■ Dimensions

Part Number	T
DLP11S	0.82±0.1
DLP11R	0.5±0.1
DLP11T	0.3±0.05

Legend: Electrode (in mm)

■ Equivalent Circuit

No polarity.

■ Packaging

Code	Packaging	Minimum Quantity
L	180mm Reel Embossed Tape	3000 (DLP11S)
		4000 (DLP11RN/RB)
		5000 (DLP11T)
B	Bulk(Bag)	500

Refer to pages from p.194 to p.197 for mounting information.

■ Rated Value (□: packaging code)

Part Number	Common Mode Impedance (at 100MHz/20°C)	Rated Current	Rated Voltage	Insulation Resistance (min.)	Withstand Voltage	DC Resistance	
DLP11SN670SL2□	67ohm ±20%	180mA	5Vdc	100M ohm	12.5Vdc	1.3ohm±25%	Kit HD
DLP11SN121SL2□	120ohm ±20%	140mA	5Vdc	100M ohm	12.5Vdc	2.0ohm±25%	Kit HD
DLP11SN161SL2□	160ohm ±20%	120mA	5Vdc	100M ohm	12.5Vdc	2.7ohm±25%	Kit HD
DLP11SN900HL2□	90ohm ±20%	150mA	5Vdc	100M ohm	12.5Vdc	1.5ohm±25%	Kit HD
DLP11SN201HL2□	200ohm ±20%	110mA	5Vdc	100M ohm	12.5Vdc	3.1ohm±25%	Kit HD
DLP11SN241HL2□	240ohm ±20%	100mA	5Vdc	100M ohm	12.5Vdc	3.5ohm±25%	Kit HD
DLP11SN281HL2□	280ohm ±20%	90mA	5Vdc	100M ohm	12.5Vdc	4.2ohm±25%	Kit HD
DLP11SN331HL2□	330ohm ±20%	80mA	5Vdc	100M ohm	12.5Vdc	4.9ohm±25%	Kit HD
DLP11SA350HL2□	35ohm ±20%	170mA	5Vdc	100M ohm	12.5Vdc	0.9ohm±25%	Kit UD
DLP11SA670HL2□	67ohm ±20%	150mA	5Vdc	100M ohm	12.5Vdc	1.2ohm±25%	Kit UD
DLP11SA900HL2□	90ohm ±20%	150mA	5Vdc	100M ohm	12.5Vdc	1.4ohm±25%	Kit UD

Operating Temperature Range: -40°C to +85°C Number of Circuit: 1

HD: for high speed differential signal lines

UD: for ultra high speed differential signal lines

■ Impedance-Frequency Characteristics DLP11SN Series

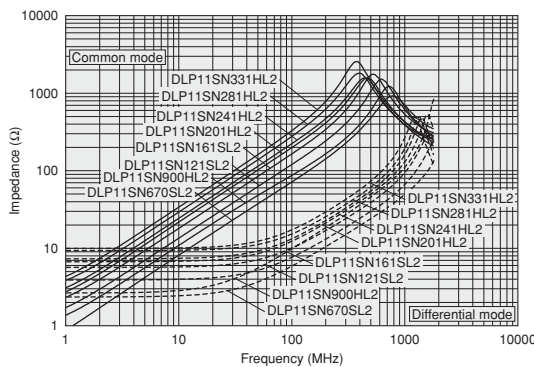

DLP11SA Series

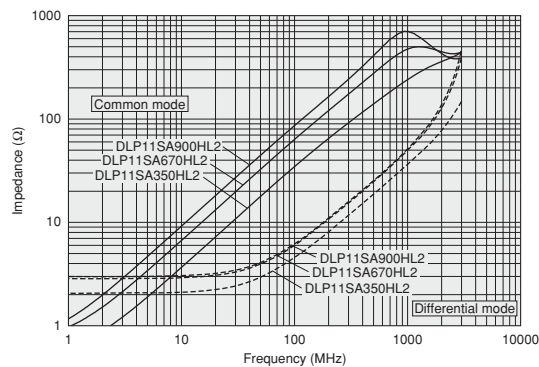

Continued on the following page.

△Note • Please read rating and CAUTION (for storage, operating, rating, soldering, mounting and handling) in this catalog to prevent smoking and/or burning, etc.
• This catalog has only typical specifications. Therefore, please approve our product specifications or transact the approval sheet for product specifications before ordering.

Differential Mode Transmission Characteristics (Typ.)

DLP11SN Series

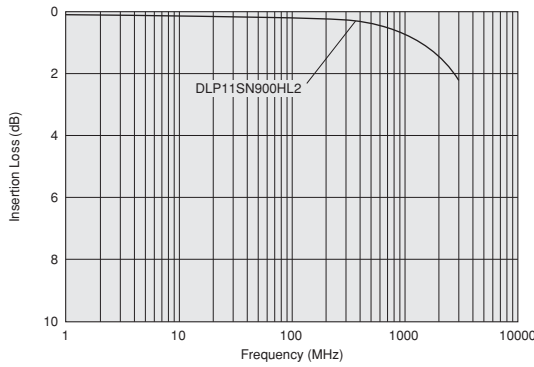

DLP11SA Series

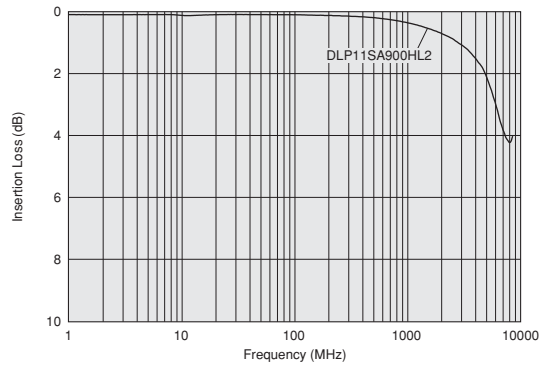

Rated Value (□: packaging code)

Part Number	Common Mode Impedance (at 100MHz/20°C)	Rated Current	Rated Voltage	Insulation Resistance (min.)	Withstand Voltage	DC Resistance	
DLP11RN450UL2□	45ohm ±25%	100mA	5Vdc	100M ohm	12.5Vdc	0.8ohm±25%	Kit HD
DLP11RB150UL2□	15ohm ±5ohm	100mA	5Vdc	100M ohm	12.5Vdc	0.8ohm±25%	Kit UD
DLP11RB400UL2□	40ohm ±10ohm	100mA	5Vdc	100M ohm	12.5Vdc	1.3ohm±25%	Kit UD

Operating Temperature Range: -40°C to +85°C Number of Circuit: 1 HD: for high speed differential signal lines UD: for ultra high speed differential signal lines

Differential mode to common mode conversion characteristic (Scd21) at 2.5GHz

DLP11RB: -40dB

Impedance Characteristics between signal lines Z0 (TDR at 50ps)

DLP11RB: 90ohm±15ohm

Impedance-Frequency Characteristics

DLP11RN Series

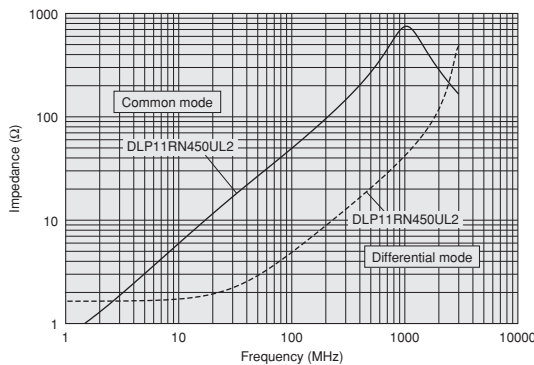

DLP11RB Series

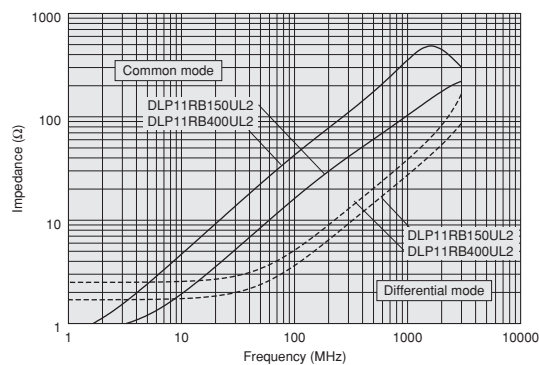

Differential Mode Transmission Characteristics (Typ.)

DLP11RN Series

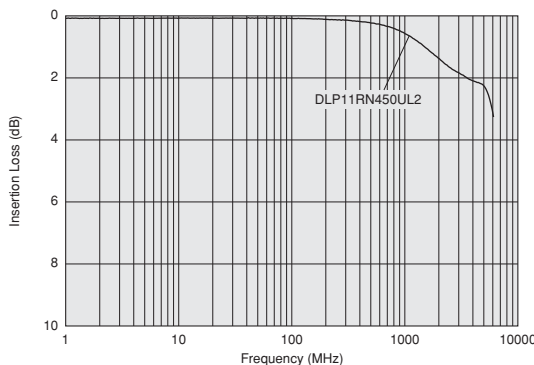

DLP11RB Series

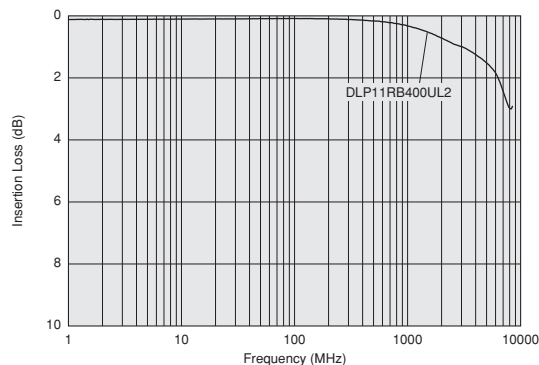

Continued on the following page.

Note • Please read rating and **CAUTION** (for storage, operating, rating, soldering, mounting and handling) in this catalog to prevent smoking and/or burning, etc.
 • This catalog has only typical specifications. Therefore, please approve our product specifications or transact the approval sheet for product specifications before ordering.

Chip Ferrite Bead
Chip EMIFIL®
Chip Common Mode Choke Coil Signal Lines Type
Block Type EMIFIL®
Microwave Absorber

■ Rated Value (□: packaging code)

Part Number	Common Mode Impedance (at 100MHz/20°C)	Rated Current	Rated Voltage	Insulation Resistance (min.)	Withstand Voltage	DC Resistance	
DLP11TB800UL2□	80ohm ±25%	100mA	5Vdc	100M ohm	12.5Vdc	1.5ohm±25%	Kit UD

Operating Temperature Range: -40°C to +85°C Number of Circuit: 1
 Differential mode to common mode conversion characteristic (Scd21) at 2.5GHz
 DLP11TB: -40dB
 Impedance Characteristics between signal lines Z0 (TDR at 50ps)
 DLP11TB: 90ohm±15ohm

HD: for high speed differential signal lines UD: for ultra high speed differential signal lines

■ Impedance-Frequency Characteristics
 DLP11TB Series

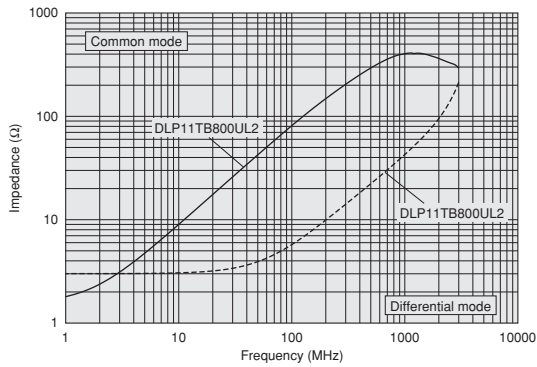

■ Differential Mode Transmission Characteristics (Typ.)
 DLP11TB Series

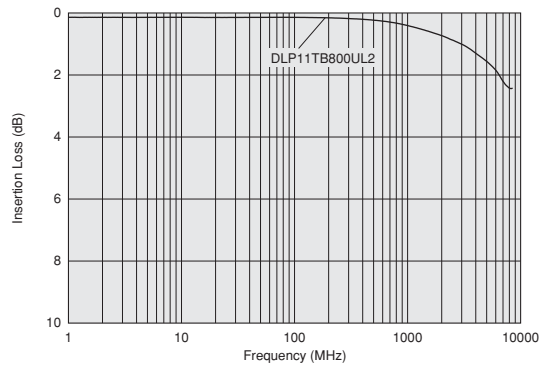

⚠Note • Please read rating and ⚠CAUTION (for storage, operating, rating, soldering, mounting and handling) in this catalog to prevent smoking and/or burning, etc.
 • This catalog has only typical specifications. Therefore, please approve our product specifications or transact the approval sheet for product specifications before ordering.

DLP31S Series (1206 Size)



1206 size film type chip common mode choke coil.



■ Dimensions

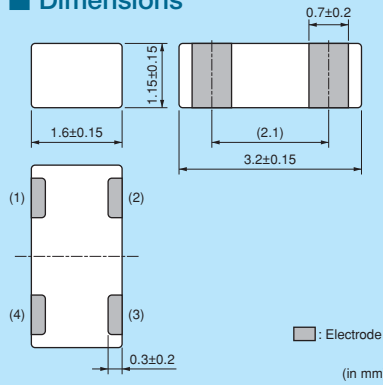

■ Equivalent Circuit

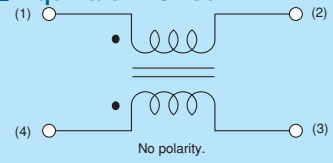

■ Packaging

Code	Packaging	Minimum Quantity
L	180mm Reel Embossed Tape	3000
B	Bulk(Bag)	500

Refer to pages from p.194 to p.197 for mounting information.

■ Rated Value (□: packaging code)

Part Number	Common Mode Impedance (at 100MHz/20°C)	Rated Current	Rated Voltage	Insulation Resistance (min.)	Withstand Voltage	DC Resistance	
DLP31SN121ML2□	120ohm $\pm 20\%$	100mA	16Vdc	100M ohm	40Vdc	2.0ohm max.	HD
DLP31SN221ML2□	220ohm $\pm 20\%$	100mA	16Vdc	100M ohm	40Vdc	2.5ohm max.	HD
DLP31SN551ML2□	550ohm $\pm 20\%$	100mA	16Vdc	100M ohm	40Vdc	3.6ohm max.	HD

Operating Temperature Range: -40°C to +85°C Number of Circuit: 1

HD: for high speed differential signal lines UD: for ultra high speed differential signal lines

■ Impedance-Frequency Characteristics

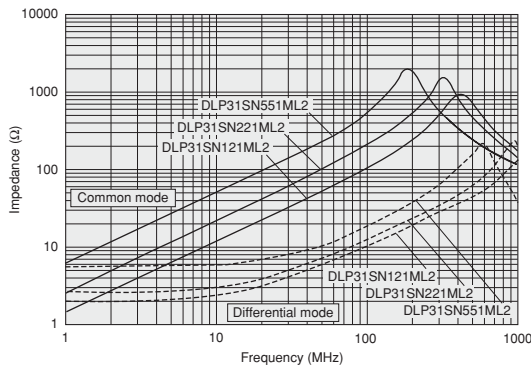

△Note • Please read rating and △CAUTION (for storage, operating, rating, soldering, mounting and handling) in this catalog to prevent smoking and/or burning, etc.
 • This catalog has only typical specifications. Therefore, please approve our product specifications or transact the approval sheet for product specifications before ordering.

Chip Ferrite Bead

Chip EMIFIL®

Chip Common Mode Choke Coil
Signal Lines Type

Block Type EMIFIL®

Microwave Absorber

DLP1ND Series (05025 Size)



2 circuits in 05025 size, adapt to HDMI line.

■ Dimensions

■ Electrode
(in mm)

■ Equivalent Circuit

■ Packaging

Code	Packaging	Minimum Quantity
L	180mm Reel Embossed Tape	5000
B	Bulk(Bag)	500

Refer to pages from p.194 to p.197 for mounting information.

■ Rated Value (□: packaging code)

Part Number	Common Mode Impedance (at 100MHz/20°C)	Rated Current	Rated Voltage	Insulation Resistance (min.)	Withstand Voltage	DC Resistance	
DLP1NDN350HL4□	35ohm ±20%	100mA	5Vdc	100M ohm	12.5Vdc	1.8ohm±25%	Kit HD UHP
DLP1NDN670HL4□	67ohm ±20%	80mA	5Vdc	100M ohm	12.5Vdc	2.9ohm±25%	Kit HD UHP
DLP1NDN900HL4□	90ohm ±20%	60mA	5Vdc	100M ohm	12.5Vdc	3.7ohm±25%	Kit HD UHP

Operating Temperature Range: -40°C to +85°C Number of Circuit: 2

HD: for high speed differential signal lines UD: for ultra high speed differential signal lines

■ Impedance-Frequency Characteristics

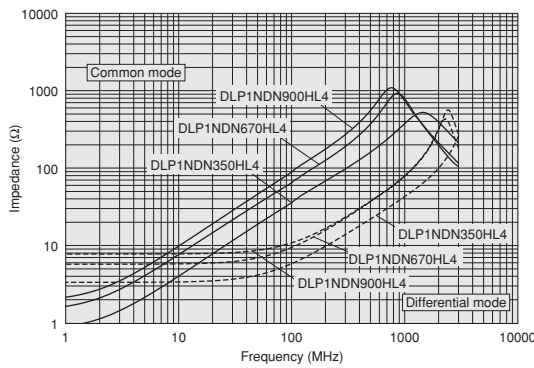

■ Differential Mode Transmission Characteristics (Typ.)

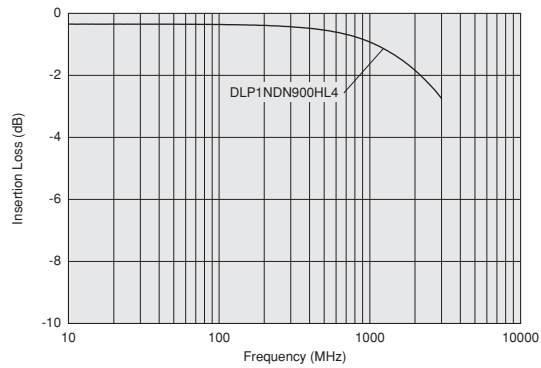

⚠Note • Please read rating and ⚠CAUTION (for storage, operating, rating, soldering, mounting and handling) in this catalog to prevent smoking and/or burning, etc.
• This catalog has only typical specifications. Therefore, please approve our product specifications or transact the approval sheet for product specifications before ordering.

DLP2AD Series (0804 Size)



2 circuit built-in, 0804 size, HDMI adapted type available, cut-off frequency 6GHz max.

■ Dimensions

0.25±0.1, 0.5±0.1, 0.92±0.1, 0.25±0.15, 1.0±0.1, 2.0±0.1

□ : Electrode (in mm)

■ Equivalent Circuit

■ Packaging

Code	Packaging	Minimum Quantity
L	180mm Reel Embossed Tape	3000
B	Bulk(Bag)	500

Refer to pages from p.194 to p.197 for mounting information.

■ Rated Value (□: packaging code)

Part Number	Common Mode Impedance (at 100MHz/20°C)	Rated Current	Rated Voltage	Insulation Resistance (min.)	Withstand Voltage	DC Resistance	
DLP2ADA350HL4□	35ohm ±20%	150mA	5Vdc	100M ohm	12.5Vdc	0.8ohm±25%	Kit UD
DLP2ADA670HL4□	67ohm ±20%	130mA	5Vdc	100M ohm	12.5Vdc	1.0ohm±25%	Kit UD
DLP2ADA900HL4□	90ohm ±20%	120mA	5Vdc	100M ohm	12.5Vdc	1.4ohm±25%	Kit UD
DLP2ADN670HL4□	67ohm ±20%	140mA	5Vdc	100M ohm	12.5Vdc	1.3ohm±25%	Kit HD
DLP2ADN900HL4□	90ohm ±20%	130mA	5Vdc	100M ohm	12.5Vdc	1.7ohm±25%	Kit HD
DLP2ADN121HL4□	120ohm ±20%	120mA	5Vdc	100M ohm	12.5Vdc	2.0ohm±25%	Kit HD
DLP2ADN161HL4□	160ohm ±20%	100mA	5Vdc	100M ohm	12.5Vdc	2.5ohm±25%	Kit HD
DLP2ADN201HL4□	200ohm ±20%	90mA	5Vdc	100M ohm	12.5Vdc	3.2ohm±25%	Kit HD
DLP2ADN241HL4□	240ohm ±20%	80mA	5Vdc	100M ohm	12.5Vdc	3.8ohm±25%	Kit HD
DLP2ADN281HL4□	280ohm ±20%	80mA	5Vdc	100M ohm	12.5Vdc	4.6ohm±25%	Kit HD

Operating Temperature Range: -40°C to +85°C Number of Circuit: 2

HD: for high speed differential signal lines

UD: for ultra high speed differential signal lines

■ Impedance-Frequency Characteristics

DLP2ADA Series

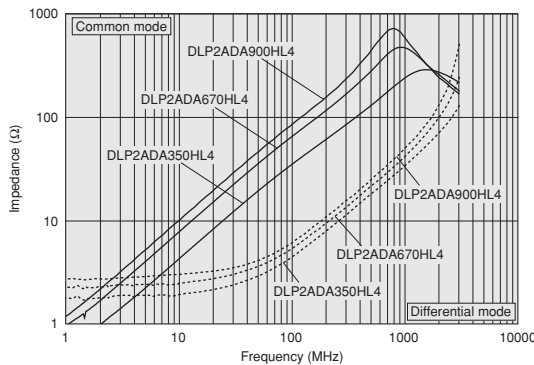

DLP2ADN Series

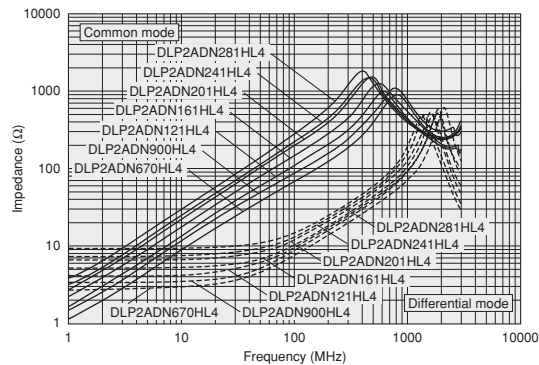

Continued on the following page.

△Note • Please read rating and △CAUTION (for storage, operating, rating, soldering, mounting and handling) in this catalog to prevent smoking and/or burning, etc.
 • This catalog has only typical specifications. Therefore, please approve our product specifications or transact the approval sheet for product specifications before ordering.

■ Differential Mode Transmission Characteristics (Typ.)

DLP2ADA Series

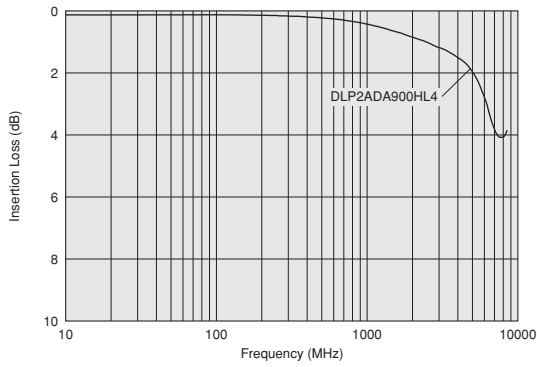

DLP2ADN Series

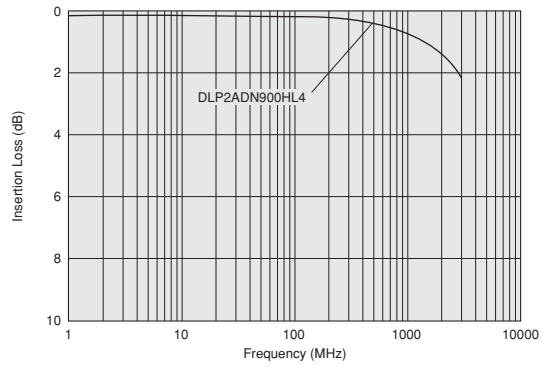

Chip Ferrite Bead

Chip EMIFIL®

Signal Lines Type
 Chip Common Mode Choke Coil

Block Type EMIFIL®

Microwave Absorber

⚠Note • Please read rating and ⚠CAUTION (for storage, operating, rating, soldering, mounting and handling) in this catalog to prevent smoking and/or burning, etc.
 • This catalog has only typical specifications. Therefore, please approve our product specifications or transact the approval sheet for product specifications before ordering.

DLP31D Series (1206 Size)



2 circuit built-in, 1206 size, meet IEEE1394,USB,LVDS.

■ Dimensions

(in mm)

■ Equivalent Circuit

■ Packaging

Code	Packaging	Minimum Quantity
L	180mm Reel Embossed Tape	3000
B	Bulk(Bag)	500

Refer to pages from p.194 to p.197 for mounting information.

■ Rated Value (□: packaging code)

Part Number	Common Mode Impedance (at 100MHz/20°C)	Rated Current	Rated Voltage	Insulation Resistance (min.)	Withstand Voltage	DC Resistance	
DLP31DN900ML4□	90ohm ±20%	160mA	10Vdc	100M ohm	25Vdc	1.1ohm max.	HD
DLP31DN131ML4□	130ohm ±20%	120mA	10Vdc	100M ohm	25Vdc	1.1ohm max.	HD
DLP31DN201ML4□	200ohm ±20%	100mA	10Vdc	100M ohm	25Vdc	2.2ohm max.	HD
DLP31DN321ML4□	320ohm ±20%	80mA	10Vdc	100M ohm	25Vdc	3.5ohm max.	HD
DLP31DN441ML4□	440ohm ±20%	70mA	10Vdc	100M ohm	25Vdc	4.3ohm max.	HD

Operating Temperature Range: -40°C to +85°C Number of Circuit: 2

HD: for high speed differential signal lines UD: for ultra high speed differential signal lines

■ Impedance-Frequency Characteristics

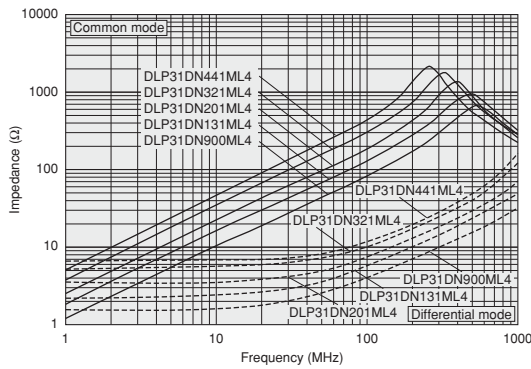

△Note • Please read rating and △CAUTION (for storage, operating, rating, soldering, mounting and handling) in this catalog to prevent smoking and/or burning, etc.
 • This catalog has only typical specifications. Therefore, please approve our product specifications or transact the approval sheet for product specifications before ordering.

Chip Ferrite Bead

Chip EMIFIL®

Chip Common Mode Choke Coil
Signal Lines Type

Block Type EMIFIL®

Microwave Absorber

DLW21S Series (0805 Size)



Wire-wound common choke, HDMI available type prepared.

■ Dimensions

(in mm)

■ Equivalent Circuit

No polarity.

■ Packaging

Code	Packaging	Minimum Quantity
L	180mm Reel Embossed Tape	2000
B	Bulk(Bag)	500

Refer to pages from p.194 to p.197 for mounting information.

■ Rated Value (□: packaging code)

Part Number	Common Mode Impedance (at 100MHz/20°C)	Rated Current	Rated Voltage	Insulation Resistance (min.)	Withstand Voltage	DC Resistance	
DLW21SN670SQ2□	67ohm ±25%	400mA	50Vdc	10M ohm	125Vdc	0.25ohm max.	Kit HD
DLW21SN900SQ2□	90ohm ±25%	330mA	50Vdc	10M ohm	125Vdc	0.35ohm max.	Kit HD
DLW21SN121SQ2□	120ohm ±25%	370mA	50Vdc	10M ohm	125Vdc	0.30ohm max.	Kit HD
DLW21SN181SQ2□	180ohm ±25%	330mA	50Vdc	10M ohm	125Vdc	0.35ohm max.	Kit HD
DLW21SN261SQ2□	260ohm ±25%	300mA	50Vdc	10M ohm	125Vdc	0.40ohm max.	Kit HD
DLW21SN371SQ2□	370ohm ±25%	280mA	50Vdc	10M ohm	125Vdc	0.45ohm max.	Kit HD
DLW21SN501SK2□	500ohm ±25%	250mA	50Vdc	10M ohm	125Vdc	0.5ohm max.	Kit HD

Operating Temperature Range: -40°C to +85°C Number of Circuit: 1

HD: for high speed differential signal lines UD: for ultra high speed differential signal lines

■ Impedance-Frequency Characteristics

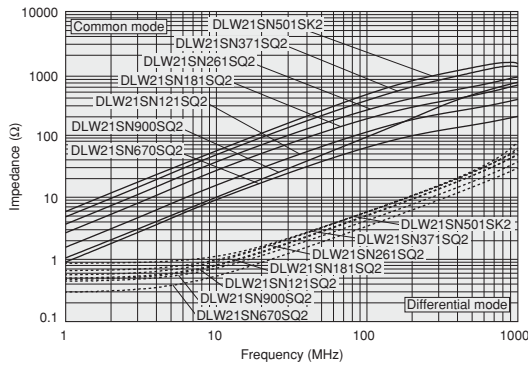

■ Rated Value (□: packaging code)

Part Number	Common Mode Impedance (at 100MHz/20°C)	Rated Current	Rated Voltage	Insulation Resistance (min.)	Withstand Voltage	DC Resistance	
DLW21SN670HQ2□	67ohm ±25%	320mA	20Vdc	10M ohm	50Vdc	0.31ohm max.	Kit UD Imp
DLW21SN900HQ2□	90ohm ±25%	280mA	20Vdc	10M ohm	50Vdc	0.41ohm max.	Kit UD Imp
DLW21SN121HQ2□	120ohm ±25%	280mA	20Vdc	10M ohm	50Vdc	0.41ohm max.	Kit UD Imp
DLW21SR670HQ2□	67ohm ±25%	400mA	20Vdc	10M ohm	50Vdc	0.25ohm max.	Kit UD Imp

Operating Temperature Range: -40°C to +85°C Number of Circuit: 1

HD: for high speed differential signal lines UD: for ultra high speed differential signal lines

DLW21SR670HQ2 is designed to correct line impedance when ESD protection device is also used.

Continued on the following page. ↗

△Note • Please read rating and △CAUTION (for storage, operating, rating, soldering, mounting and handling) in this catalog to prevent smoking and/or burning, etc.
• This catalog has only typical specifications. Therefore, please approve our product specifications or transact the approval sheet for product specifications before ordering.

Impedance-Frequency Characteristics
DLW21SN_HQ2 Series

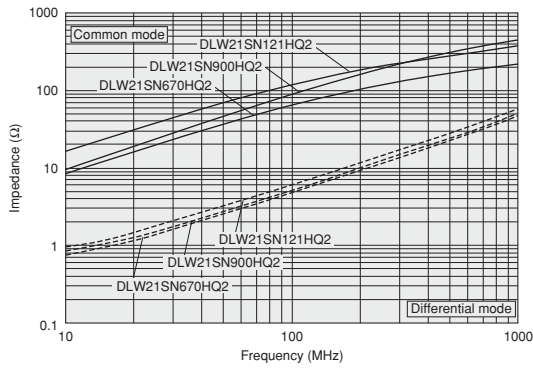

DLW21SR_HQ2 Series

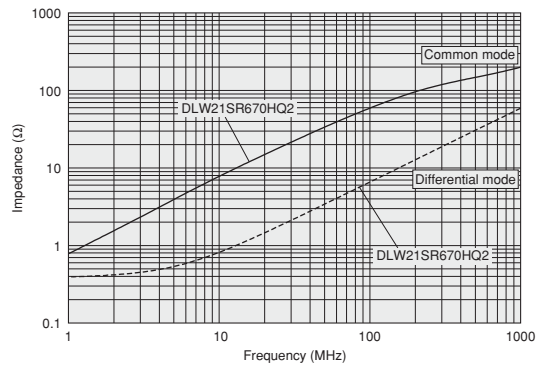

Differential Mode Transmission Characteristics (Typ.)
DLW21SN_HQ2 Series

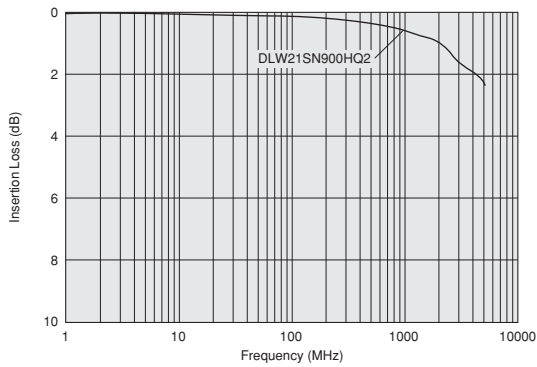

△Note • Please read rating and △CAUTION (for storage, operating, rating, soldering, mounting and handling) in this catalog to prevent smoking and/or burning, etc.
• This catalog has only typical specifications. Therefore, please approve our product specifications or transact the approval sheet for product specifications before ordering.

Chip Ferrite Bead
Chip EMIFIL®
Chip Common Mode Choke Coil
Signal Lines Type
Block Type EMIFIL®
Microwave Absorber

DLW21H Series (0805 Size)



Low profile wire-wound common choke coil, HDMI available type prepared.

■ Dimensions

(in mm)

■ Equivalent Circuit

No polarity.

■ Packaging

Code	Packaging	Minimum Quantity
L	180mm Reel Embossed Tape	3000
B	Bulk(Bag)	500

Refer to pages from p.194 to p.197 for mounting information.

■ Rated Value (□: packaging code)

Part Number	Common Mode Impedance (at 100MHz/20°C)	Rated Current	Rated Voltage	Insulation Resistance (min.)	Withstand Voltage	DC Resistance	
DLW21HN670SQ2□	67ohm ±25%	330mA	50Vdc	10M ohm	125Vdc	0.35ohm max.	Kit HD
DLW21HN900SQ2□	90ohm ±25%	330mA	50Vdc	10M ohm	125Vdc	0.35ohm max.	Kit HD
DLW21HN121SQ2□	120ohm ±25%	280mA	50Vdc	10M ohm	125Vdc	0.45ohm max.	Kit HD
DLW21HN181SQ2□	180ohm ±25%	250mA	50Vdc	10M ohm	125Vdc	0.50ohm max.	Kit HD
DLW21HN670HQ2□	67ohm ±25%	240mA	20Vdc	10M ohm	50Vdc	0.49ohm max.	New Kit UD Amp Match
DLW21HN900HQ2□	90ohm ±25%	220mA	20Vdc	10M ohm	50Vdc	0.59ohm max.	New Kit UD Amp Match
DLW21HN121HQ2□	120ohm ±25%	200mA	20Vdc	10M ohm	50Vdc	0.68ohm max.	New Kit UD Amp Match

Operating Temperature Range: -40°C to +85°C Number of Circuit: 1

HD: for high speed differential signal lines UD: for ultra high speed differential signal lines

■ Impedance-Frequency Characteristics

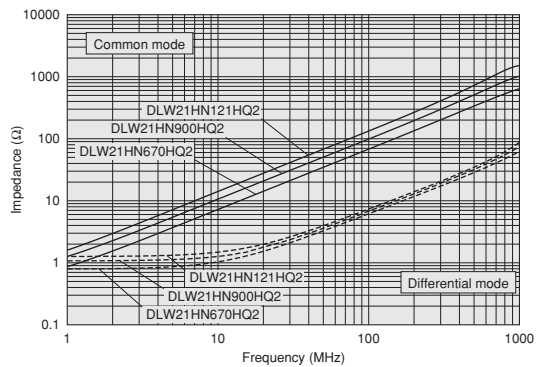
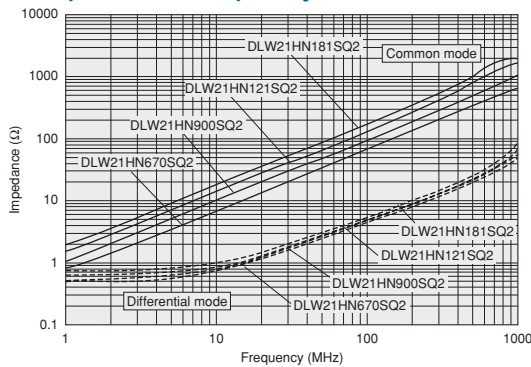

■ Differential Mode Transmission Characteristics (Typ.)

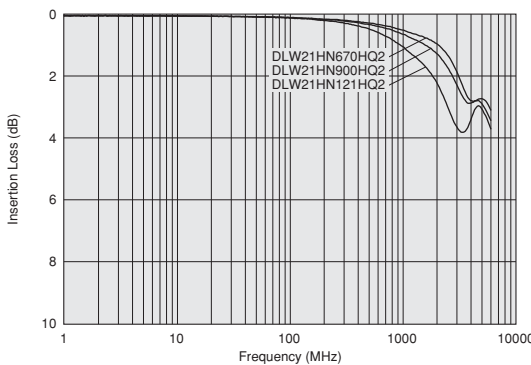

△Note • Please read rating and △CAUTION (for storage, operating, rating, soldering, mounting and handling) in this catalog to prevent smoking and/or burning, etc.
• This catalog has only typical specifications. Therefore, please approve our product specifications or transact the approval sheet for product specifications before ordering.

DLW31S Series (1206 Size)



1206 size wire-wound common mode choke coil.



Dimensions

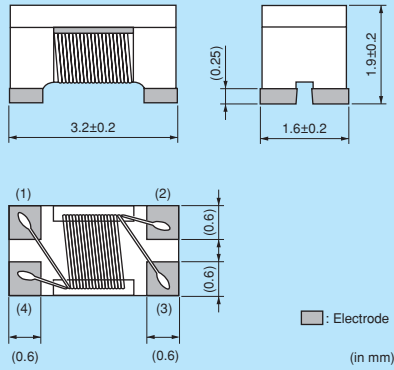

Equivalent Circuit

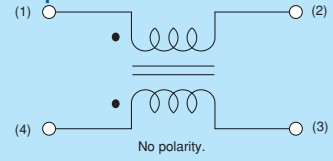

Packaging

Code	Packaging	Minimum Quantity
L	180mm Reel Embossed Tape	2000
B	Bulk(Bag)	500

Refer to pages from p.194 to p.197 for mounting information.

Rated Value (□: packaging code)

Part Number	Common Mode Impedance (at 100MHz/20°C)	Rated Current	Rated Voltage	Insulation Resistance (min.)	Withstand Voltage	DC Resistance	
DLW31SN900SQ2□	90ohm ±25%	370mA	50Vdc	10M ohm	125Vdc	0.3ohm max.	HD
DLW31SN161SQ2□	160ohm ±25%	340mA	50Vdc	10M ohm	125Vdc	0.4ohm max.	HD
DLW31SN261SQ2□	260ohm ±25%	310mA	50Vdc	10M ohm	125Vdc	0.5ohm max.	HD
DLW31SN601SQ2□	600ohm ±25%	260mA	50Vdc	10M ohm	125Vdc	0.8ohm max.	HD
DLW31SN102SQ2□	1000ohm ±25%	230mA	50Vdc	10M ohm	125Vdc	1.0ohm max.	HD
DLW31SN222SQ2□	2200ohm ±25%	200mA	50Vdc	10M ohm	125Vdc	1.2ohm max.	HD

Operating Temperature Range: -40°C to +85°C Number of Circuit: 1

HD: for high speed differential signal lines UD: for ultra high speed differential signal lines

Impedance-Frequency Characteristics

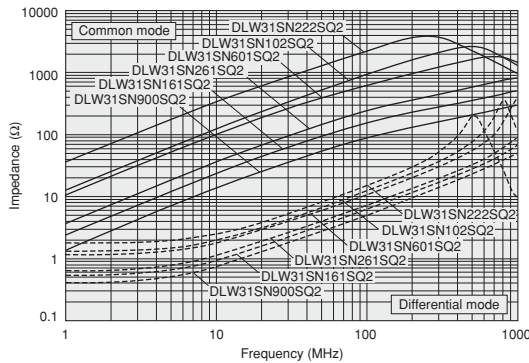

△Note • Please read rating and △CAUTION (for storage, operating, rating, soldering, mounting and handling) in this catalog to prevent smoking and/or burning, etc.
 • This catalog has only typical specifications. Therefore, please approve our product specifications or transact the approval sheet for product specifications before ordering.

Chip Ferrite Bead

Chip EMIFIL®

Chip Common Mode Choke Coil
Signal Lines Type

Block Type EMIFIL®

Microwave Absorber

PLT10H Series (12.9x6.6mm)



Automotive application available, up to 18A.

■ Dimensions

■ Equivalent Circuit

■ Packaging

Code	Packaging	Minimum Quantity
L	180mm Reel Embossed Tape	125
K	330mm Reel Embossed Tape	500
B	Bulk(Bag)	50

Refer to pages from p.198 to p.199 for mounting information.

■ Rated Value (□: packaging code)

Part Number	Common Mode Impedance (at 10MHz/20°C)	Rated Current	Rated Voltage	Insulation Resistance (min.)	Withstand Voltage	DC Resistance	Inductance	
PLT10HH450180PN□	45ohm (Typ.)	18A	300Vdc	10M ohm	750Vdc	1.3m ohm±0.5m ohm	0.8µH min.	New Kit ≥10A
PLT10HH101150PN□	100ohm (Typ.)	15A	300Vdc	10M ohm	750Vdc	1.8m ohm±0.5m ohm	2.0µH min.	New Kit ≥10A
PLT10HH401100PN□	400ohm (Typ.)	10A	100Vdc	10M ohm	250Vdc	3.6m ohm±0.5m ohm	6µH min.	Kit ≥10A
PLT10HH501100PN□	500ohm (Typ.)	10A	100Vdc	10M ohm	250Vdc	3.6m ohm±0.5m ohm	9µH min.	Kit ≥10A
PLT10HH9016R0PN□	900ohm (Typ.)	6A	100Vdc	10M ohm	250Vdc	8.0m ohm±0.5m ohm	14µH min.	Kit ≥3A
PLT10HH1026R0PN□	1000ohm (Typ.)	6A	100Vdc	10M ohm	250Vdc	8.0m ohm±0.5m ohm	20µH min.	Kit ≥3A

Operating Temperature Range (Self-temperature rise is included): -55°C to +105°C (PLT10HH 501100/1026R0 PN), -55°C to +125°C (PLT10HH 450180/101150/401100/9016R0 PN) Number of Circuit: 1

■ Impedance-Frequency Characteristics

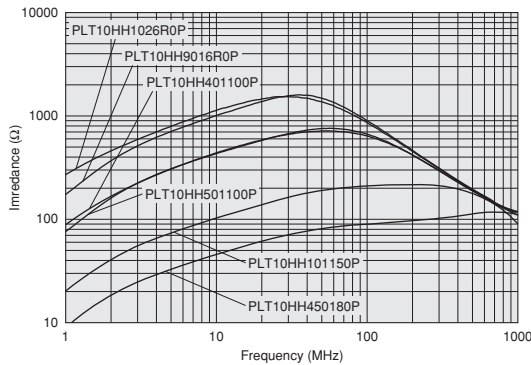

■ Notice (Rating)

In operating temperature exceeding +65°C, derating of current is necessary for PLT10H series.

Please apply the derating curve shown in chart according to the operating temperature.

Derating of Rated Current

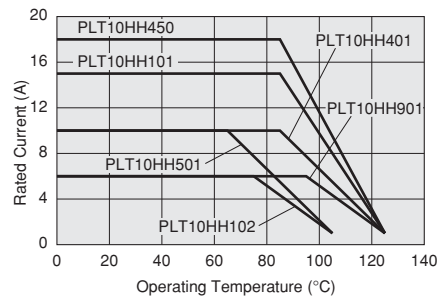

△Note • Please read rating and △CAUTION (for storage, operating, rating, soldering, mounting and handling) in this catalog to prevent smoking and/or burning, etc.
• This catalog has only typical specifications. Therefore, please approve our product specifications or transact the approval sheet for product specifications before ordering.

⚠ Caution

● Rating

Do not use products beyond the rated current and rated voltage as this may create excessive heat and deteriorate the insulation resistance.

● Soldering and Mounting

1. Self-heating

Please provide special attention when mounting chip common mode choke coils DLW5 series in close proximity to other products that radiate heat. The heat generated by other products may deteriorate the insulation resistance and cause excessive heat in this component.

2. Mounting Direction

Mount Chip Common Mode Choke Coils in right direction. Wrong direction, which is 90 degrees rotated from right direction, causes not only open or short circuit but also flames or other serious trouble.

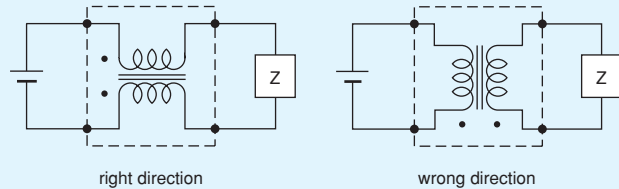

● Storage and Operating Conditions

<Operating Environment>

Do not use products in a chemical atmosphere such as chlorine gas, acid or sulfide gas. Do not use products in the environment close to the organic solvent.

<Storage and Handling Requirements>

1. Storage Period

DLM11G series should be used within 6 months, the other series should be used within 12 months. Solderability should be checked if this period is exceeded.

2. Storage Conditions

- (1) Storage temperature: -10 to +40°C
Relative humidity: 15 to 85%
Avoid sudden changes in temperature and humidity.
- (2) Do not store products in a chemical atmosphere such as chlorine gas, acid or sulfide gas.

● Notice (Soldering and Mounting)

1. Cleaning

Failure and degradation of a product are caused by the cleaning method. When you clean in conditions that are not in mounting information, please contact Murata engineering.

2. Soldering

Reliability decreases with improper soldering methods. Please solder by the standard soldering conditions shown in mounting information.

3. Other

Noise suppression levels resulting from Murata's EMI suppression filters EMIFIL® may vary, depending on the circuits and ICs used, type of noise, mounting pattern, mounting location, and other operating conditions. Be sure to check and confirm in advance the noise suppression effect of each filter, in actual circuits, etc. before applying the filter in a commercial-purpose equipment design.

Notice

● Handling

1. Resin Coating (Except for DLW Series.)

Using resin for coating/molding products may affect the products performance. So please pay careful attention in selecting resin. Prior to use, please make the reliability evaluation with the product mounted in your application set.

2. Resin Coating (DLW Series)

The impedance value may change due to high cure-stress of resin to be used for coating/molding products. An open circuit issue may occur by mechanical stress caused by the resin, amount/cured shape of resin, or operating condition etc. Some resin contains some impurities or chloride possible to generate chlorine by hydrolysis under some operating condition may cause corrosion of wire of coil, leading to open circuit. So, please pay your careful attention in selecting resin in case of coating/molding the products with the resin. Prior to use the coating resin, please make sure no reliability issue is observed by evaluating products mounted on your board.

3. Caution for Use (DLW Series)

When you hold products with a tweezer, please hold by the sides. Sharp materials, such as a pair of tweezers, should not touch the winding portion to prevent breaking the wire. Mechanical shock should not be applied to the products mounted on the board to prevent breaking the core.

4. Brushing

When you clean the neighborhood of products such as connector pins, bristles of cleaning brush shall not be touched to the winding portion of this product to prevent the breaking of wire.

5. Handling of a Substrate

After mounting products on a substrate, do not apply any stress to the product caused by bending or twisting to the substrate when cropping the substrate, inserting and removing a connector from the substrate or tightening screw to the substrate. Excessive mechanical stress may cause cracking in the Product.



⚠ Note • Please read rating and ⚠ CAUTION (for storage, operating, rating, soldering, mounting and handling) in this catalog to prevent smoking and/or burning, etc.
• This catalog has only typical specifications. Therefore, please approve our product specifications or transact the approval sheet for product specifications before ordering.

⚠ Caution

● **Rating**

1. Do not use products beyond the rated current and rated voltage as this may create excessive heat and deteriorate the insulation resistance.
2. Be sure to provide an appropriate fail-safe function on your product to prevent a second damage that may be caused by the abnormal function or the failure our product.

● **Soldering and Mounting**

1. Self-heating

Please provide special attention when mounting chip common mode choke coils in close proximity to other products that radiate heat. The heat generated by other products may deteriorate the insulation resistance and cause excessive heat in this component.

2. Mounting Direction

Mount Chip Common Mode Choke Coils in right direction. Wrong direction, which is 90 degrees rotated from right direction, causes not only open or short circuit but also flames or other serious trouble.

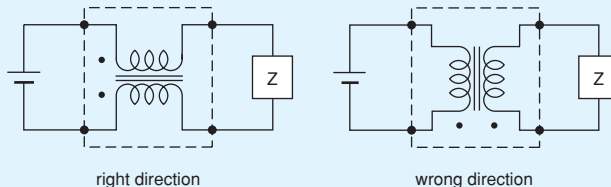

● **Storage and Operating Conditions**

<Operating Environment>

Do not use products in a chemical atmosphere such as chlorine gas, acid or sulfide gas.

Do not use products in the environment close to the organic solvent.

<Storage and Handling Requirements>

1. Storage Period

PLT10H series should be used within 12 months. Solderability should be checked if this period is exceeded.

2. Storage Conditions

- (1) Storage temperature: -10 to +40°C
Relative humidity: 15 to 85%
Avoid sudden changes in temperature and humidity.
- (2) Do not store products in a chemical atmosphere such as chlorine gas, acid or sulfide gas.

● **Notice (Soldering and Mounting)**

1. Cleaning

Failure and degradation of a product are caused by the cleaning method. When you clean in conditions that are not in mounting information, please contact Murata engineering.

2. Soldering

Reliability decreases with improper soldering methods. Please solder by the standard soldering conditions shown in mounting information.

3. Other

Noise suppression levels resulting from Murata's EMI suppression filters EMIFIL® may vary, depending on the circuits and ICs used, type of noise, mounting pattern, mounting location, and other operating conditions. Be sure to check and confirm in advance the noise suppression effect of each filter, in actual circuits, etc. before applying the filter in a commercial-purpose equipment design.

● **Handling**

1. Handling of a Substrate

After mounting products on a substrate, do not apply any stress to the product caused by bending or twisting to the substrate when cropping the substrate, inserting and removing a connector from the substrate or tightening screw to the substrate.

Excessive mechanical stress may cause cracking in the Product.

Bending

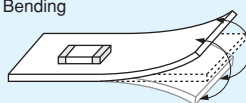

Twisting

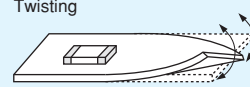

⚠ Note • Please read rating and ⚠ CAUTION (for storage, operating, rating, soldering, mounting and handling) in this catalog to prevent smoking and/or burning, etc.
• This catalog has only typical specifications. Therefore, please approve our product specifications or transact the approval sheet for product specifications before ordering.

1. Standard Land Pattern Dimensions

Land Pattern + Solder Resist
 Land Pattern
 Solder Resist (in mm)

DLM11S
 DLM11G
 DLP0QS
 DLP0NS
 DLP11S
 DLP11R
 DLP11T
 DLP1ND
 DLP2AD
 DLP31S
 DLP31D
 DLW21S
 DLW21H
 DLW31SN
 DLW5A
 DLW5B

● Reflow and Flow
DLP31S

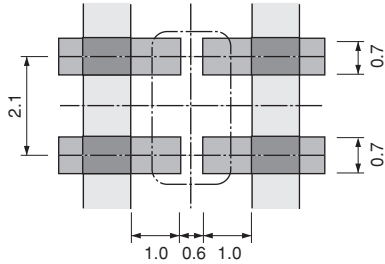

DLP31D

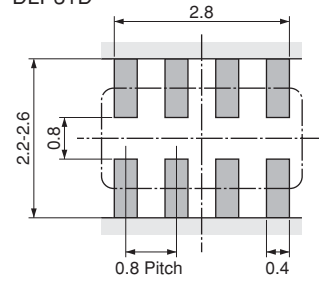

● Reflow Soldering

DLP0QS

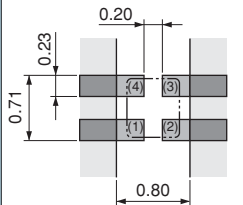

DLP0NS

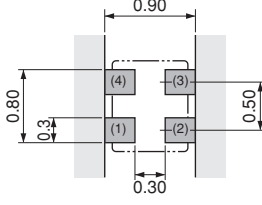

DLP11S/DLM11S

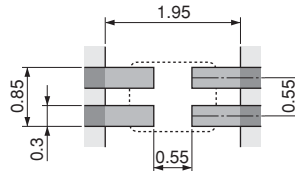

DLP11R/11T

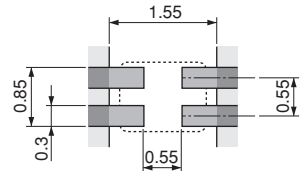

DLP1ND

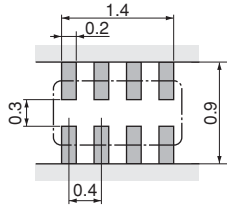

DLP2AD

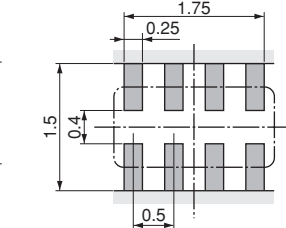

DLM11G

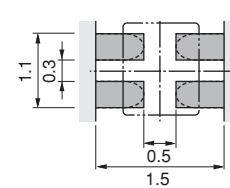

DLW21S/21H/31SN

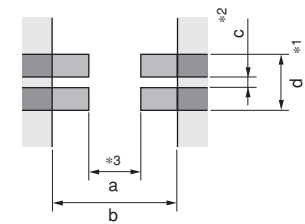

DLW5A/5B (Except for DLW5AT_MQ2)

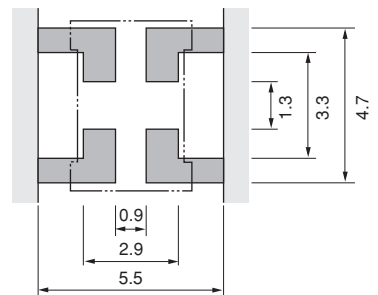

Series	a	b	c	d
DLW21S/H	0.8	2.6	0.4	1.2
DLW31SN	1.6	3.7	0.4	1.6

*1: If the pattern is made with wider than 1.2mm (DLW21) / 1.6mm (DLW31S) it may result in components turning around, because melting speed is different. In the worst case, short circuit between lines may occur.
 *2: If the pattern is made with less than 0.4mm, in the worst case, short circuit between lines may occur due to spread of soldering paste or mount placing accuracy.
 *3: If the pattern is made with wider than 0.8mm (DLW21) / 1.6mm (DLW31SN), the bending strength will be reduced.
 Do not use gild pattern; excess soldering heat may dissolve metal of a copper wire.

DLW5AT_MQ2

● Reflow Soldering Chip Mounting Side
DLW5AT_MQ2

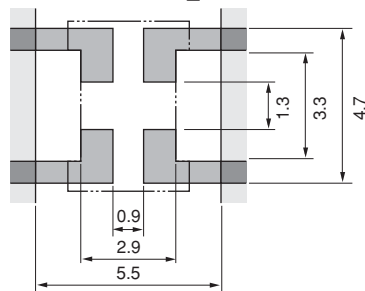

● Flow Soldering Chip Mounting Side
DLW5AT_MQ2

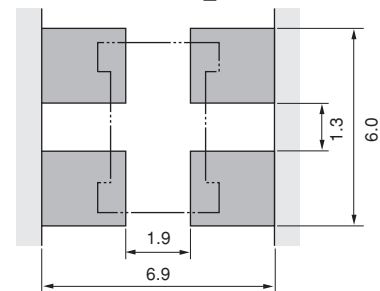

⚠ Note • Please read rating and ⚠ CAUTION (for storage, operating, rating, soldering, mounting and handling) in this catalog to prevent smoking and/or burning, etc.
 • This catalog has only typical specifications. Therefore, please approve our product specifications or transact the approval sheet for product specifications before ordering.

Chip Ferrite Bead
 Chip EMIFIL®
 Soldering and Mounting
 Chip Common Mode Choke Coil
 Block Type EMIFIL®
 Microwave Absorber

● PCB Warping

PCB should be designed so that products are not subjected to the mechanical stress caused by warping the board.

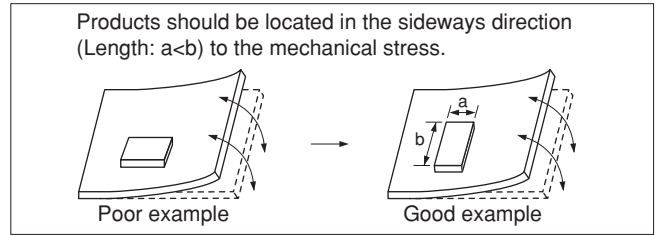

2. Solder Paste Printing and Adhesive Application

When reflow soldering the chip common mode choke coils, the printing must be conducted in accordance with the following cream solder printing conditions.

If too much solder is applied, the chip will be prone to damage by mechanical and thermal stress from the PCB and may crack.

Standard land dimensions should be used for resist and copper foil patterns.

When flow soldering the chip common mode choke coils, apply the adhesive in accordance with the following conditions.

If too much adhesive is applied, then it may overflow into the land or termination areas and yield poor solderability. In contrast, if insufficient adhesive is applied, or if the adhesive is not sufficiently hardened, then the chip may become detached during flow soldering process.

(in mm)

Series	Solder Paste Printing	Adhesive Application																																																							
DLP DLW DLM	<p>●Guideline of solder paste thickness: 80-100µm: DLP0QS 100-150µm: DLW21S/21H/31S, DLP0NS/11S/11R/11T/1ND/2AD/DLM11G 150-200µm: DLP31D/31S, DLW5A/5B</p> <p>*Solderability is subject to reflow conditions and thermal conductivity. Please make sure that your product has been evaluated in view of your specifications with our product being mounted to your product.</p> <p>DLP0QS/0NS/11S/11R/11T/31S/DLM11G DLW21S/21H/31S</p> <table border="1"> <thead> <tr> <th>Series</th> <th>a</th> <th>b</th> <th>c</th> <th>d</th> </tr> </thead> <tbody> <tr> <td>DLP0QS</td> <td>0.3</td> <td>0.2</td> <td>0.23</td> <td>0.48</td> </tr> <tr> <td>DLP0NS</td> <td>0.3</td> <td>0.3</td> <td>0.3</td> <td>0.5</td> </tr> <tr> <td>DLP11S</td> <td>0.7</td> <td>0.55</td> <td>0.3</td> <td>0.55</td> </tr> <tr> <td>DLP11R/T</td> <td>0.5</td> <td>0.55</td> <td>0.3</td> <td>0.55</td> </tr> <tr> <td>DLP31S</td> <td>1.0</td> <td>0.6</td> <td>0.7</td> <td>2.1</td> </tr> <tr> <td>DLM11G</td> <td>0.5</td> <td>0.5</td> <td>0.4</td> <td>0.7</td> </tr> </tbody> </table> <p>DLP1ND/2AD/31D</p> <table border="1"> <thead> <tr> <th>Series</th> <th>a</th> <th>b</th> <th>c</th> <th>d</th> </tr> </thead> <tbody> <tr> <td>DLP1ND</td> <td>0.3</td> <td>0.3</td> <td>0.2</td> <td>0.4</td> </tr> <tr> <td>DLP2AD</td> <td>0.55</td> <td>0.4</td> <td>0.25</td> <td>0.5</td> </tr> <tr> <td>DLP31D</td> <td>1.0</td> <td>0.8</td> <td>0.4</td> <td>0.8</td> </tr> </tbody> </table> <p>DLW5A/5B</p>	Series	a	b	c	d	DLP0QS	0.3	0.2	0.23	0.48	DLP0NS	0.3	0.3	0.3	0.5	DLP11S	0.7	0.55	0.3	0.55	DLP11R/T	0.5	0.55	0.3	0.55	DLP31S	1.0	0.6	0.7	2.1	DLM11G	0.5	0.5	0.4	0.7	Series	a	b	c	d	DLP1ND	0.3	0.3	0.2	0.4	DLP2AD	0.55	0.4	0.25	0.5	DLP31D	1.0	0.8	0.4	0.8	<p>■ DLP31S/DLP31D/DLW5AT_MQ2 Apply 0.3mg of bonding agent at each chip.</p> <p>DLP31D DLP31S</p> <p>Coating Position of Bonding Agent</p> <p>DLW5AT_MQ2</p> <p>Coating Position of Bonding Agent</p>
	Series	a	b	c	d																																																				
	DLP0QS	0.3	0.2	0.23	0.48																																																				
	DLP0NS	0.3	0.3	0.3	0.5																																																				
	DLP11S	0.7	0.55	0.3	0.55																																																				
	DLP11R/T	0.5	0.55	0.3	0.55																																																				
	DLP31S	1.0	0.6	0.7	2.1																																																				
	DLM11G	0.5	0.5	0.4	0.7																																																				
	Series	a	b	c	d																																																				
	DLP1ND	0.3	0.3	0.2	0.4																																																				
DLP2AD	0.55	0.4	0.25	0.5																																																					
DLP31D	1.0	0.8	0.4	0.8																																																					

△Note • Please read rating and △CAUTION (for storage, operating, rating, soldering, mounting and handling) in this catalog to prevent smoking and/or burning, etc.
 • This catalog has only typical specifications. Therefore, please approve our product specifications or transact the approval sheet for product specifications before ordering.

3. Standard Soldering Conditions

(1) Soldering Methods

Use flow and reflow soldering methods only.
 Use standard soldering conditions when soldering chip common mode choke coils.
 In cases where several different parts are soldered, each having different soldering conditions, use those conditions requiring the least heat and minimum time.

Solder: Use Sn-3.0Ag-0.5Cu solder. Use of Sn-Zn based solder will deteriorate performance of products.
 If using DLP/DLM series with Sn-Zn based solder, please contact Murata in advance.

Flux:

- Use Rosin-based flux.
 In case of DLW21/31 series, use Rosin-based flux with converting chlorine content of 0.06 to 0.1wt%.
 In case of using RA type solder, products should be cleaned completely with no residual flux.
- Do not use strong acidic flux (with chlorine content exceeding 0.20wt%)
- Do not use water-soluble flux.

For additional mounting methods, please contact Murata.

(2) Soldering Profile

● **Flow Soldering Profile**
 (Sn-3.0Ag-0.5Cu Solder)

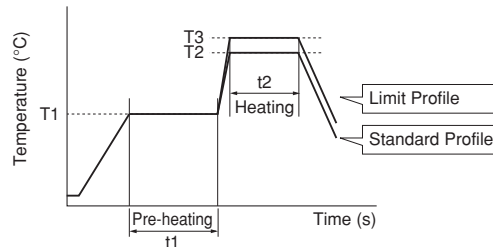

Series	Pre-heating		Standard Profile			Limit Profile		
	Temp. (T1)	Time. (t1)	Heating		Cycle of Flow	Heating		Cycle of Flow
			Temp. (T2)	Time. (t2)		Temp. (T3)	Time. (t2)	
DLW5AT_MQ2 DLP31D/31S	150°C	60s min.	250°C	4 to 6s	2 times max.	265±3°C	5s max.	2 times max.

● **Reflow Soldering Profile**
 (Sn-3.0Ag-0.5Cu Solder)

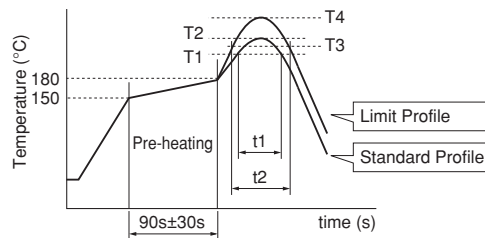

Series	Standard Profile				Limit Profile			
	Heating		Peak Temperature (T2)	Cycle of Reflow	Heating		Peak Temperature (T4)	Cycle of Reflow
	Temp. (T1)	Time. (t1)			Temp. (T3)	Time. (t2)		
DLM/DLP DLW21/31	220°C min.	30 to 60s	245±3°C	2 times max.	230°C min.	60s max.	260°C/10s	2 times max.
DLW5A/5B	220°C min.	30 to 60s	250±3°C	2 times max.	230°C min.	60s max.	260°C/10s	2 times max.

△Note • Please read rating and △CAUTION (for storage, operating, rating, soldering, mounting and handling) in this catalog to prevent smoking and/or burning, etc.
 • This catalog has only typical specifications. Therefore, please approve our product specifications or transact the approval sheet for product specifications before ordering.

Chip Ferrite Bead
Chip EMIFIL®
Soldering and Mounting
Chip Common Mode Choke Coil
Block Type EMIFIL®
Microwave Absorber

(3) Reworking with Solder Iron

The following conditions must be strictly followed when using a soldering iron.

Pre-heating: 150°C 60s min.

Soldering iron power output / Tip diameter:

30W max. / ø3mm max.

Temperature of soldering iron tip / Soldering time / Times:

350°C max. / 3-4s / 2 times*¹

*¹ DLP0QS, DLP0NS, DLP11S, DLP11T, DLP1ND,
DLP2AD: 380°C max. / 3-4s / 2 times

Do not allow the tip of the soldering iron to directly contact the chip.

For additional methods of reworking with a soldering iron, please contact Murata engineering.

4. Cleaning

Following conditions should be observed when cleaning chip EMI filter.

(1) Cleaning Temperature: 60°C max. (40°C max. for alcohol type cleaner)

(2) Ultrasonic

Output: 20W/liter max.

Duration: 5 minutes max.

Frequency: 28 to 40kHz

(3) Cleaning agent

The following list of cleaning agents have been tested on the individual components. Evaluation of final assembly should be completed prior to production.

Do not clean DLW (Except for DLW21H) series.

Before cleaning, please contact Murata engineering.

(a) Alcohol cleaning agent

Isopropyl alcohol (IPA)

(b) Aqueous cleaning agent

Pine Alpha ST-100S

(4) Ensure that flux residue is completely removed.

Component should be thoroughly dried after aqueous agent has been removed with deionized water.

⚠Note • Please read rating and ⚠CAUTION (for storage, operating, rating, soldering, mounting and handling) in this catalog to prevent smoking and/or burning, etc.
• This catalog has only typical specifications. Therefore, please approve our product specifications or transact the approval sheet for product specifications before ordering.

1. Standard Land Pattern Dimensions

(in mm)

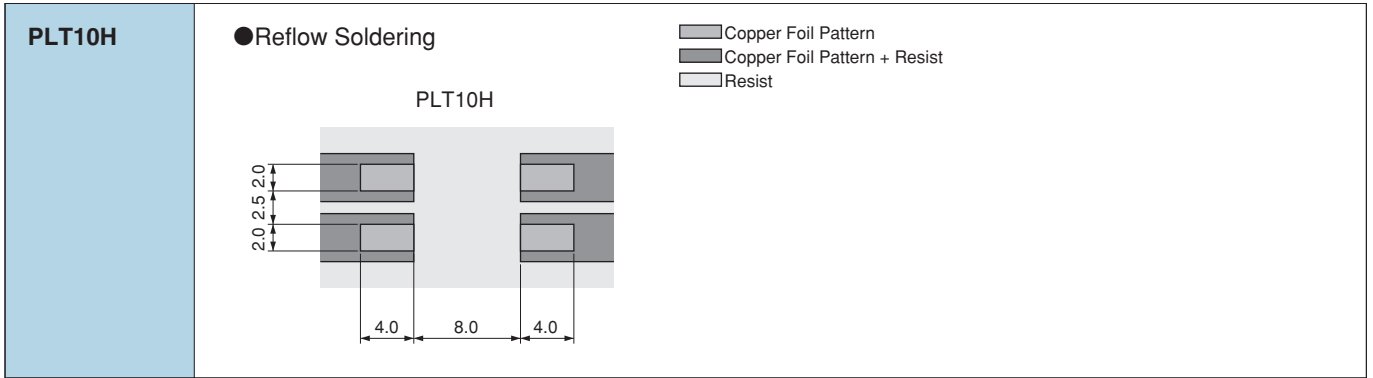

● PCB Warping

PCB should be designed so that products are not subjected to the mechanical stress caused by warping the board.

Products should be located in the sideways direction (Length: a<b) to the mechanical stress.

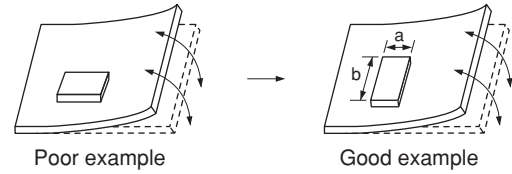

2. Solder Paste Printing and Adhesive Application

When reflow soldering the chip common mode choke coils, the printing must be conducted in accordance with the following cream solder printing conditions.

If too much solder is applied, the chip will be prone to damage by mechanical and thermal stress from the PCB and may crack.

Standard land dimensions should be used for resist and copper foil patterns.

When flow soldering the chip common mode choke coils, apply the adhesive in accordance with the following conditions.

If too much adhesive is applied, then it may overflow into the land or termination areas and yield poor solderability. In contrast, if insufficient adhesive is applied, or if the adhesive is not sufficiently hardened, then the chip may become detached during flow soldering process.

Series	Solder Paste Printing
PLT10H	<p>● Guideline of solder paste thickness: 150-200μm: PLT10H For the solder paste printing pattern, use standard land dimensions.</p> <p>*Solderability is subject to reflow conditions and thermal conductivity. Please make sure that your product has been evaluated in view of your specifications with our product being mounted to your product.</p>

△Note • Please read rating and △CAUTION (for storage, operating, rating, soldering, mounting and handling) in this catalog to prevent smoking and/or burning, etc.
• This catalog has only typical specifications. Therefore, please approve our product specifications or transact the approval sheet for product specifications before ordering.

Chip Ferrite Bead
Chip EMIFIL®
Soldering and Mounting
Chip Common Mode Choke Coil
Block Type EMIFIL®
Microwave Absorber

3. Standard Soldering Conditions

(1) Soldering Methods

Use reflow soldering methods only.
 Use standard soldering conditions when soldering chip common mode choke coils.
 In cases where several different parts are soldered, each having different soldering conditions, use those conditions requiring the least heat and minimum time.

Solder: Use Sn-3.0Ag-0.5Cu solder. Use of Sn-Zn based solder will deteriorate performance of products.

Flux:

- Use Rosin-based flux.
- Do not use strong acidic flux (with chlorine content exceeding 0.20wt%)
- Do not use water-soluble flux.

For additional mounting methods, please contact Murata.

(2) Soldering Profile

● Reflow Soldering Profile
 (Sn-3.0Ag-0.5Cu Solder)

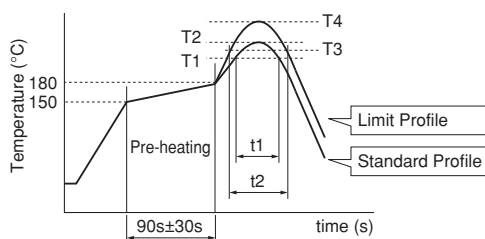

Series	Standard Profile				Limit Profile			
	Heating		Peak Temperature (T2)	Cycle of Reflow	Heating		Peak Temperature (T4)	Cycle of Reflow
	Temp. (T1)	Time. (t1)			Temp. (T3)	Time. (t2)		
PLT10H	220°C min.	30 to 60s	250±3°C	2 times max.	230°C min.	60s max.	260°C/10s	2 times max.

(3) Reworking with Solder Iron

The following conditions must be strictly followed when using a soldering iron.
 Pre-heating: 150°C 60s min.
 Soldering iron power output / Tip diameter:
 80W max. / ø3mm max.
 Temperature of soldering iron tip / Soldering time / Times:
 400°C max. / 5s / 2 times

Do not allow the tip of the soldering iron to directly contact the chip.
 For additional methods of reworking with a soldering iron, please contact Murata engineering.

4. Cleaning

Do not clean after soldering. If cleaning, please contact us.

△Note • Please read rating and △CAUTION (for storage, operating, rating, soldering, mounting and handling) in this catalog to prevent smoking and/or burning, etc.
 • This catalog has only typical specifications. Therefore, please approve our product specifications or transact the approval sheet for product specifications before ordering.

■ Minimum Quantity and Dimensions of 8mm Width Paper / Embossed Tape

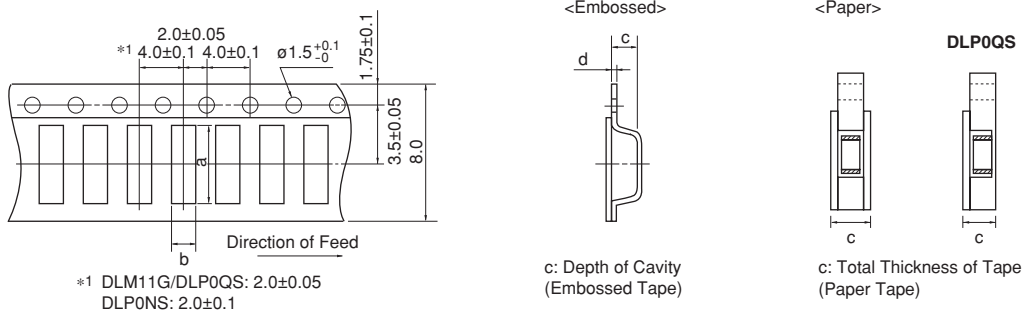

Dimension of the cavity of embossed tape is measured at the bottom side.

Part Number	Dimensions				Minimum Qty. (pcs.)				Bulk
					ø180mm Reel		ø330mm Reel		
	a	b	c	d	Paper Tape	Embossed Tape	Paper Tape	Embossed Tape	
DLM11G	1.45	1.2	0.8 max.	-	10000	-	-	-	1000
DLM11S	1.4	1.15	0.65	0.25	-	4000	-	-	500
DLP0QS	0.73	0.6	0.55 max.	-	15000	-	-	-	500
DLP0NS	0.95	0.75	0.55	0.25	-	10000	-	-	500
DLP11S	1.4	1.2	0.98	0.25	-	3000	-	-	500
DLP11R	1.4	1.15	0.7	0.25	-	4000	-	-	500
DLP11T	1.35	1.1	0.45	0.25	-	5000	-	-	500
DLP1ND	1.7	0.84	0.57	0.25	-	5000	-	-	500
DLP2AD	2.2	1.2	0.98	0.25	-	3000	-	-	500
DLP31D/31S	3.5	1.9	1.3	0.25	-	3000	-	-	500
DLW21S	2.25	1.45	1.4	0.3	-	2000	-	-	500
DLW21H	2.3	1.55	1.1	0.25	-	3000	-	-	500
DLW31S	3.6	2.0	2.1	0.3	-	2000	-	-	500

(in mm)

■ Minimum Quantity and Dimensions of 12mm Width Embossed Tape

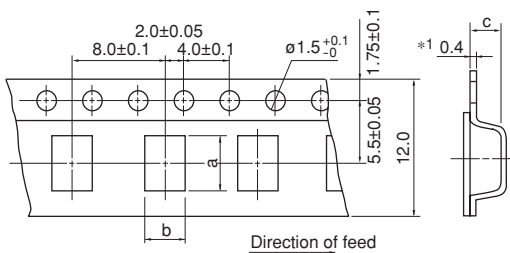

*1 DLW5AT: 0.3 c: Depth of Cavity

Dimension of the cavity is measured at the bottom side.

Part Number	Dimensions			Minimum Qty. (pcs.)		
	a	b	c	ø180mm Reel	ø330mm Reel	Bulk
DLW5AH	5.4	4.1	4.4	400	1500	100
DLW5AT	5.4	4.1	2.7	700	2500	100
DLW5BS	5.5	5.4	4.7	400	1500	100
DLW5BT	5.5	5.5	2.7	700	2500	100

(in mm)

"Minimum Quantity" means the number of units of each delivery or order. The quantity should be an integral multiple of the "Minimum Quantity."

△Note • Please read rating and △CAUTION (for storage, operating, rating, soldering, mounting and handling) in this catalog to prevent smoking and/or burning, etc.
• This catalog has only typical specifications. Therefore, please approve our product specifications or transact the approval sheet for product specifications before ordering.



Minimum Quantity and Dimensions of 24mm Width Embossed Tape

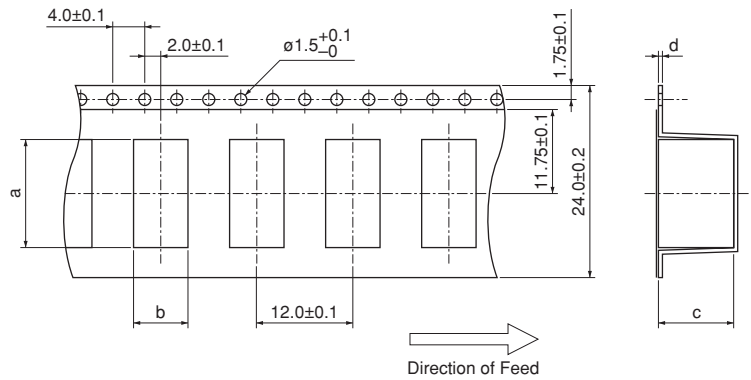

Dimension of the cavity is measured at the bottom side.

Part Number	Dimensions				Minimum Qty. (pcs.)		
	a	b	c	d	ø180mm Reel	ø330mm Reel	Bulk
PLT10H	13.5	6.8	9.4	0.5	125	500	50

(in mm)

⚠Note • Please read rating and ⚠CAUTION (for storage, operating, rating, soldering, mounting and handling) in this catalog to prevent smoking and/or burning, etc.
• This catalog has only typical specifications. Therefore, please approve our product specifications or transact the approval sheet for product specifications before ordering.



●EKEMDL21P (Chip Common Mode Choke Coils)

No.	Part Number	Quantity (pcs.)	Common Mode Impedance (at 100MHz, 20 degrees C)	Rated Voltage (Vdc)	Rated Current (mA)
1	DLW21HN670SQ2	10	67Ω±25%	50	330
2	DLW21HN900SQ2	10	90Ω±25%	50	330
3	DLW21HN121SQ2	10	120Ω±25%	50	280
4	DLW21HN181SQ2	10	180Ω±25%	50	250
5	DLW21HN670HQ2	10	67Ω±25%	20	240
6	DLW21HN900HQ2	10	90Ω±25%	20	220
7	DLW21HN121HQ2	10	120Ω±25%	20	200
8	DLW21SN501SK2	10	500Ω±25%	50	250
9	DLW21SN670SQ2	10	67Ω±25%	50	400
10	DLW21SN900SQ2	10	90Ω±25%	50	330
11	DLW21SN121SQ2	10	120Ω±25%	50	370
12	DLW21SN181SQ2	10	180Ω±25%	50	330
13	DLW21SN261SQ2	10	260Ω±25%	50	300
14	DLW21SN371SQ2	10	370Ω±25%	50	280
15	DLW21SN670HQ2	10	67Ω±25%	20	320
16	DLW21SN900HQ2	10	90Ω±25%	20	280
17	DLW21SN121HQ2	10	120Ω±25%	20	280
18	DLW21SR670HQ2	10	67Ω±25%	20	400
19	DLP0NSC280HL2	10	28Ω±20%	5	100
20	DLP0NSN350HL2	10	35Ω±10Ω	5	100
21	DLP0NSN670HL2	10	67Ω±20%	5	110
22	DLP0NSN900HL2	10	90Ω±20%	5	100
23	DLP0NSN121HL2	10	120Ω±20%	5	90
24	DLP0NSA070HL2	10	7Ω±2Ω	5	100
25	DLP0NSA150HL2	10	15Ω±5Ω	5	100
26	DLP0QSN600HL2	10	60Ω±25%	5	50
27	DLP0QSA070HL2	10	7Ω±2Ω	5	100
28	DLP0QSA150HL2	10	15Ω±5Ω	5	100
29	DLP0QSA350HL2	10	35Ω±10Ω	5	100
30	DLP1NDN350HL4	10	35Ω±20%	5	100
31	DLP1NDN670HL4	10	67Ω±20%	5	80
32	DLP1NDN900HL4	10	90Ω±20%	5	60
33	DLP11SA350HL2	10	35Ω±20%	5	170
34	DLP11SA670HL2	10	67Ω±20%	5	150
35	DLP11SA900HL2	10	90Ω±20%	5	150
36	DLP11SN670SL2	10	67Ω±20%	5	180
37	DLP11SN121SL2	10	120Ω±20%	5	140
38	DLP11SN161SL2	10	160Ω±20%	5	120
39	DLP11SN900HL2	10	90Ω±20%	5	150
40	DLP11SN201HL2	10	200Ω±20%	5	110
41	DLP11SN241HL2	10	240Ω±20%	5	100
42	DLP11SN281HL2	10	280Ω±20%	5	90
43	DLP11SN331HL2	10	330Ω±20%	5	80
44	DLP11RB150UL2	10	15Ω±5Ω	5	100
45	DLP11RB400UL2	10	40Ω±10Ω	5	100
46	DLP11RN450UL2	10	45Ω±25%	5	100
47	DLP11TB800UL2	10	80Ω±25%	5	100
48	DLP2ADA350HL4	10	35Ω±20%	5	150
49	DLP2ADA670HL4	10	67Ω±20%	5	130
50	DLP2ADA900HL4	10	90Ω±20%	5	120
51	DLP2ADN670HL4	10	67Ω±20%	5	140
52	DLP2ADN900HL4	10	90Ω±20%	5	130
53	DLP2ADN121HL4	10	120Ω±20%	5	120
54	DLP2ADN161HL4	10	160Ω±20%	5	100
55	DLP2ADN201HL4	10	200Ω±20%	5	90

Continued on the following page.

△Note • Please read rating and △CAUTION (for storage, operating, rating, soldering, mounting and handling) in this catalog to prevent smoking and/or burning, etc.
 • This catalog has only typical specifications. Therefore, please approve our product specifications or transact the approval sheet for product specifications before ordering.

Continued from the preceding page.

No.	Part Number	Quantity (pcs.)	Common Mode Impedance (at 100MHz, 20 degrees C)	Rated Voltage (Vdc)	Rated Current (mA)
56	DLP2ADN241HL4	10	240Ω±20%	5	80
57	DLP2ADN281HL4	10	280Ω±20%	5	80
58	DLM11SN450HY2	10	45Ω±25%	5	100
59	DLM11SN900HY2	10	90Ω±25%	5	100

●EKEMDCC5E (Chip Common Mode Choke Coils for DC Power Line / SMD Block type EMIFIL® for Power Line)

No.	Part Number	Quantity (pcs.)	Common Mode Impedance (at 100MHz, 20 degrees C)	Rated Voltage (Vdc)	Rated Current (mA)
1	DLW5AHN402SQ2	5	4000Ω (Typ.)	50	200
2	DLW5ATN111SQ2	5	110Ω (Typ.)	50	5000
3	DLW5ATN401SQ2	5	400Ω (Typ.)	50	2000
4	DLW5ATN501SQ2	5	500Ω (Typ.)	50	1500
5	DLW5ATN851SQ2	5	850Ω (Typ.)	50	1500
6	DLW5ATN272SQ2	5	2700Ω (Typ.)	50	1000
7	DLW5BSM191SQ2	5	190Ω (Typ.)	50	5000
8	DLW5BSM351SQ2	5	350Ω (Typ.)	50	2000
9	DLW5BSM102SQ2	5	1000Ω (Typ.)	50	1500
10	DLW5BSM152SQ2	5	1500Ω (Typ.)	50	1000
11	DLW5BSM302SQ2	5	3000Ω (Typ.)	50	500
12	DLW5BTM101SQ2	5	100Ω (Typ.)	50	6000
13	DLW5BTM251SQ2	5	250Ω (Typ.)	50	5000
14	DLW5BTM501SQ2	5	500Ω (Typ.)	50	4000
15	DLW5BTM102SQ2	5	1000Ω (Typ.)	50	2000
16	DLW5BTM142SQ2	5	1400Ω (Typ.)	50	1500

●EKEMDL5AA (Chip Common Mode Choke Coils for DC Power Line / SMD Block type EMIFIL® for Power Line / 105 degree C available type)

No.	Part Number	Quantity (pcs.)	Common Mode Impedance (at 100MHz, 20 degrees C)	Rated Voltage (Vdc)	Rated Current (mA)
1	DLW5ATN500MQ2	5	50Ω (Typ.)	50	6000
2	DLW5ATN151MQ2	5	150Ω (Typ.)	50	5000
3	DLW5ATN331MQ2	5	330Ω (Typ.)	50	4000
4	DLW5ATN112MQ2	5	1100Ω (Typ.)	50	2000
5	DLW5ATN450TQ2	5	45Ω (Typ.)	50	7000
6	DLW5ATN111TQ2	5	110Ω (Typ.)	50	5000
7	DLW5ATN231TQ2	5	230Ω (Typ.)	50	4000
8	DLW5ATN501TQ2	5	500Ω (Typ.)	50	2000
9	DLW5BTM101TQ2	5	100Ω (Typ.)	50	6000
10	DLW5BTM251TQ2	5	250Ω (Typ.)	50	5000
11	DLW5BTM501TQ2	5	500Ω (Typ.)	50	4000
12	DLW5BTM142TQ2	5	1400Ω (Typ.)	50	2000

⚠Note • Please read rating and ⚠CAUTION (for storage, operating, rating, soldering, mounting and handling) in this catalog to prevent smoking and/or burning, etc.
• This catalog has only typical specifications. Therefore, please approve our product specifications or transact the approval sheet for product specifications before ordering.



●EKEPBLCKD

No.	Part Number	Quantity (pcs.)	Common Mode Impedance (at 10MHz, 20 degrees C)	Rated Voltage (Vdc)	Rated Current (A)
1	PLT10HH450180PN	2	45Ω (Typ.)	300	18
2	PLT10HH101150PN	2	100Ω (Typ.)	300	15
3	PLT10HH401100PN	2	400Ω (Typ.)	100	10
4	PLT10HH501100PN	2	500Ω (Typ.)	100	10
5	PLT10HH9016R0PN	2	900Ω (Typ.)	100	6
6	PLT10HH1026R0PN	2	1000Ω (Typ.)	100	6

No.	Part Number	Quantity (pcs.)	Insertion Loss	Rated Voltage (Vdc)	Rated Current (A)
7	BNX002-01	1	1MHz to 1GHz : 40dB min.	50	10
8	BNX003-01	1	5MHz to 1GHz : 40dB min.	150	10
9	BNX005-01	1	1MHz to 1GHz : 40dB min.	50	15
10	BNX012-01	1	1MHz to 1GHz : 40dB min.	50	15
11	BNX016-01	1	100kHz to 1GHz : 40dB min.	25	15
12	BNX022-01	2	1MHz to 1GHz : 35dB min.	50	10
13	BNX023-01	2	1MHz to 1GHz : 35dB min.	100	15
14	BNX024H01	2	100kHz to 1GHz : 35dB min.	50	15
15	BNX025H01	2	50kHz to 1GHz : 35dB min.	25	15

△Note • Please read rating and △CAUTION (for storage, operating, rating, soldering, mounting and handling) in this catalog to prevent smoking and/or burning, etc.
 • This catalog has only typical specifications. Therefore, please approve our product specifications or transact the approval sheet for product specifications before ordering.

Chip Ferrite Bead
 Chip EMIFIL®
 Design Kits
 Chip Common Mode Choke Coil
 Block Type EMIFIL®
 Microwave Absorber



Block Type EMIFIL®

Series Line Up	206
Function Example	206
Product Detail	209
⚠Caution/Notice	213
Soldering and Mounting	215
Packaging	219
Design Kits	220

Chip Ferrite Bead

Chip EMIFIL®

Chip Common Mode Choke Coil

Block Type EMIFIL®

Microwave Absorber

⚠Note • Please read rating and ⚠CAUTION (for storage, operating, rating, soldering, mounting and handling) in this catalog to prevent smoking and/or burning, etc.
• This catalog has only typical specifications. Therefore, please approve our product specifications or transact the approval sheet for product specifications before ordering.

Type	Part Number	Thickness (mm)	Rated Voltage	Effective Frequency Range	Rated Current	Kit	≥3A	Flow	R _{efflow}
SMD Type for Power Lines <i>p209</i>	BNX022-01	3.1	50Vdc	1MHz to 1GHz:35dB min.	10A	Kit	≥3A	Flow	R _{efflow}
	BNX023-01	3.1	100Vdc	1MHz to 1GHz:35dB min.	15A	Kit	≥3A	Flow	R _{efflow}
	BNX024H01	3.5	50Vdc	100kHz to 1GHz:35dB min.	15A	Kit	≥3A	Flow	R _{efflow}
	BNX025H01	3.5	25Vdc	50kHz to 1GHz:35dB min.	15A	Kit	≥3A	Flow	R _{efflow}
Lead Type for Power Lines <i>p211</i>	BNX002-01	18.0	50Vdc	1MHz to 1GHz:40dB min.	10A	Kit	≥3A	Flow	
	BNX003-01	18.0	150Vdc	5MHz to 1GHz:40dB min.	10A	Kit	≥3A	Flow	
	BNX005-01	18.5	50Vdc	1MHz to 1GHz:40dB min.	15A	Kit	≥3A	Flow	
Lead Type Low Profile for Power Lines <i>p212</i>	BNX012-01	8.0	50Vdc	1MHz to 1GHz:40dB min.	15A	Kit	≥3A	Flow	
	BNX016-01	8.0	25Vdc	100kHz to 1GHz:40dB min.	15A	Kit	≥3A	Flow	

Suppression of Radiation Noise from Power Line Cable

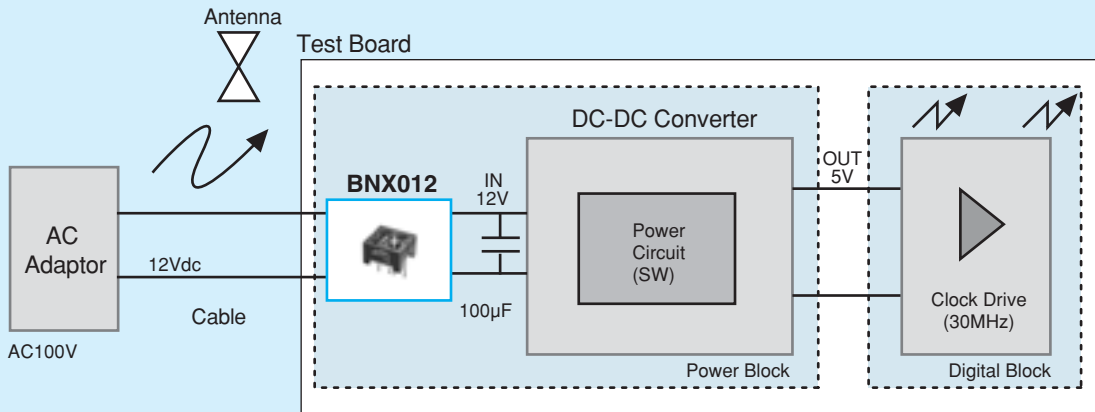

Test Result

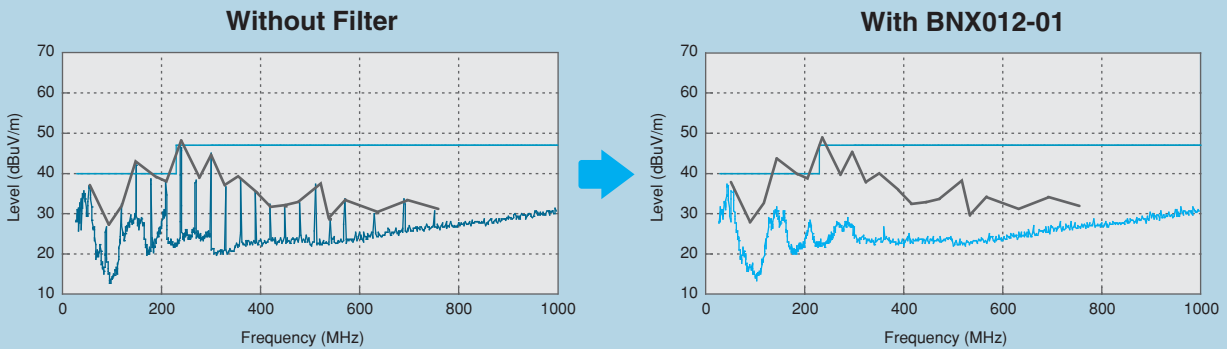

△Note • Please read rating and △CAUTION (for storage, operating, rating, soldering, mounting and handling) in this catalog to prevent smoking and/or burning, etc.
• This catalog has only typical specifications. Therefore, please approve our product specifications or transact the approval sheet for product specifications before ordering.

Impulse Noise Countermeasure

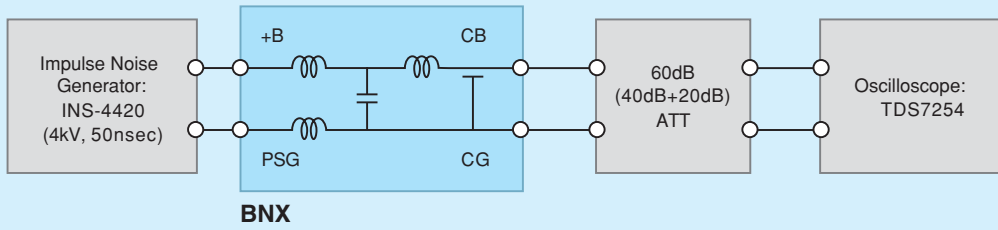

Without Filter

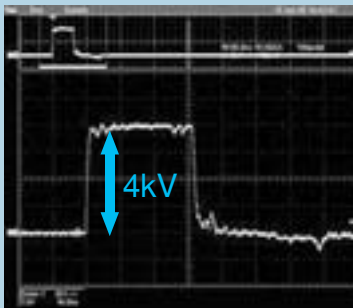

Applied Impulse Voltage: 4kV/50nS
Y-AXIS: 1kV/div

With Filter

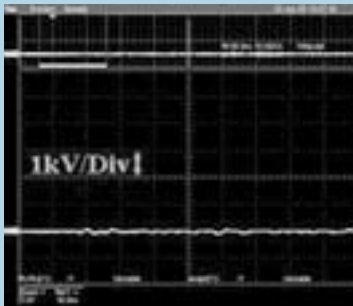

BNX002-01

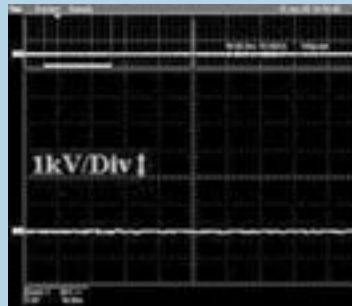

BNX012-01

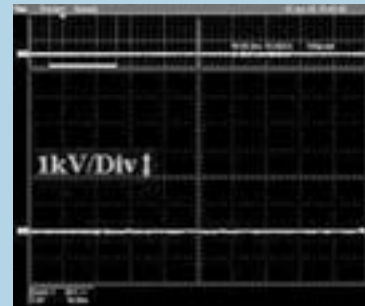

BNX022-01

ESD Countermeasure

ESD Waveform Comparison

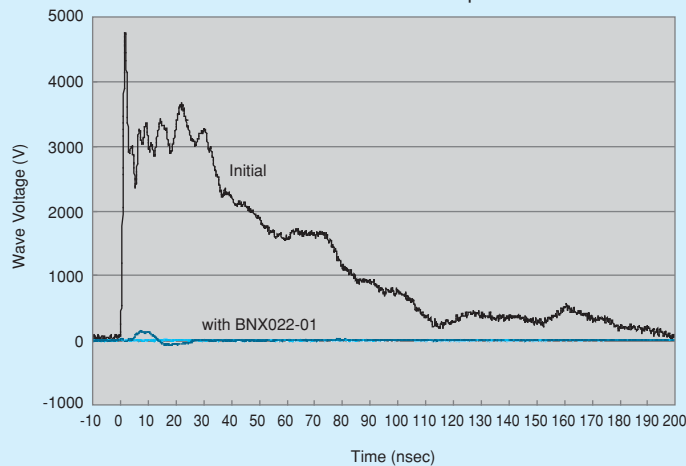

⚠Note • Please read rating and ⚠CAUTION (for storage, operating, rating, soldering, mounting and handling) in this catalog to prevent smoking and/or burning, etc.
• This catalog has only typical specifications. Therefore, please approve our product specifications or transact the approval sheet for product specifications before ordering.

Suppression of Ripple Noise of DC Side in the Switching Power Supply



Test Circuit

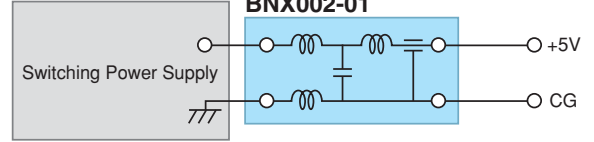

Type of Filter	EMI Suppression Effect / Description	
Without Filter	<p>+5.0V→ 50μs/div 0.2V/div</p>	<p>There is high frequency noise of 0.5V maximum.</p>
When BNX002-01 is used	<p>+5.0V→ 50μs/div 0.2V/div</p>	<p>BNX002-01 can suppress most of the noise.</p>

Example of Impulse Noise Suppression

Type of Filter	EMI Suppression Effect	
Without Filter		<p>Impulse Noise 2000V/50ns</p> <p>Y-axis: 500V/div X-axis: 10ns/sec</p>
When BNX002 is used		<p>Y-axis: 500V/div X-axis: 10ns/sec</p>

△Note • Please read rating and △CAUTION (for storage, operating, rating, soldering, mounting and handling) in this catalog to prevent smoking and/or burning, etc.
• This catalog has only typical specifications. Therefore, please approve our product specifications or transact the approval sheet for product specifications before ordering.

Chip Ferrite Bead

Chip EMIFIL®

Chip Common Mode Choke Coil

Block Type EMIFIL®

Microwave Absorber

BNX02□ Series



SMD package of block type EMIFIL®.

BNX022/BNX023



■ Dimensions

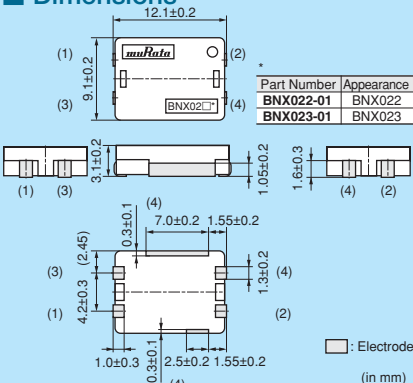

Part Number	Appearance
BNX022-01	BNX022
BNX023-01	BNX023

□: Electrode (in mm)

■ Equivalent Circuit

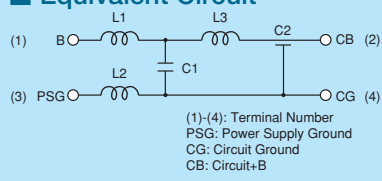

(1)-(4): Terminal Number
PSG: Power Supply Ground
CG: Circuit Ground
CB: Circuit+B

■ Packaging

Code	Packaging	Minimum Quantity
L	180mm Reel Embossed Tape	400
K	330mm Reel Embossed Tape	1500
B	Bulk(Bag)	100

BNX024H/BNX025H



■ Dimensions

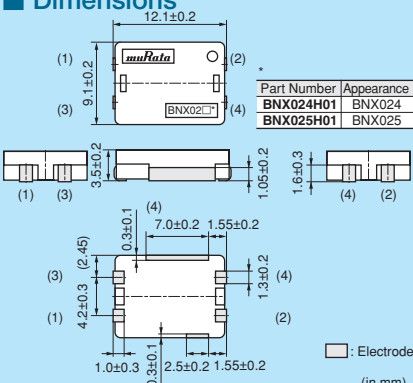

Part Number	Appearance
BNX024H01	BNX024
BNX025H01	BNX025

□: Electrode (in mm)

■ Equivalent Circuit

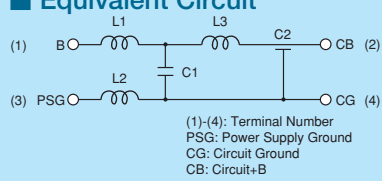

(1)-(4): Terminal Number
PSG: Power Supply Ground
CG: Circuit Ground
CB: Circuit+B

■ Packaging

Code	Packaging	Minimum Quantity
L	180mm Reel Embossed Tape	400
K	330mm Reel Embossed Tape	1500
B	Bulk(Bag)	100

Refer to pages from p.215 to p.216 for mounting information.

■ Rated Value (□: packaging code)

Part Number	Rated Voltage	Withstand Voltage	Rated Current	Insulation Resistance (min.)	Insertion Loss (20 to 25 degrees C line impedance=50 ohm)	Kit
BNX022-01□	50Vdc	125Vdc	10A	500M ohm	1MHz to 1GHz:35dB min.	Kit ≥3A
BNX023-01□	100Vdc	250Vdc	15A	500M ohm	1MHz to 1GHz:35dB min.	Kit ≥3A
BNX024H01□	50Vdc	125Vdc	15A	100M ohm	100kHz to 1GHz:35dB min.	Kit ≥3A
BNX025H01□	25Vdc	62.5Vdc	15A	50M ohm	50kHz to 1GHz:35dB min.	Kit ≥3A

Operating Temperature Range: -40°C to +125°C (BNX022/BNX023), -55°C to +125°C (BNX024H/BNX025H)

■ Insertion Loss Characteristics

BNX022/023

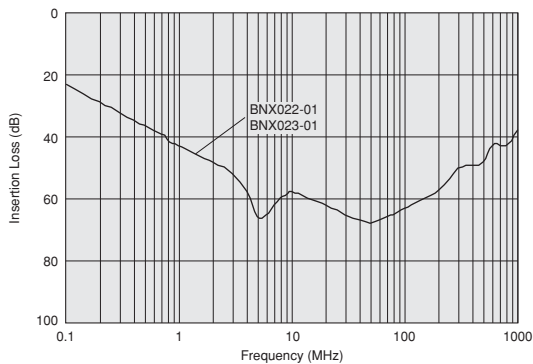

BNX024H01

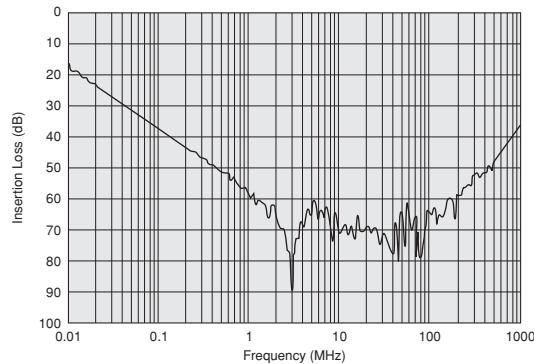

Continued on the following page. ↗

△Note • Please read rating and △CAUTION (for storage, operating, rating, soldering, mounting and handling) in this catalog to prevent smoking and/or burning, etc.
• This catalog has only typical specifications. Therefore, please approve our product specifications or transact the approval sheet for product specifications before ordering.

■ Insertion Loss Characteristics
BNX025H01

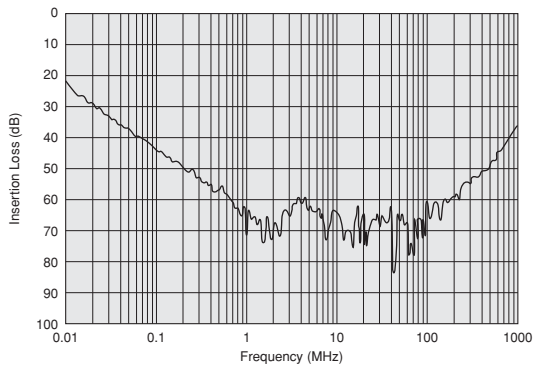

■ Notice (Rating)

In operating temperature exceeding +85°C, derating of current is necessary for BNX022 series. Please apply the derating curve shown in chart according to the operating temperature.

In operating temperature exceeding +85°C, derating of current is necessary for BNX023 series. Please apply the derating curve shown in chart according to the operating temperature.

Derating of Rated Current

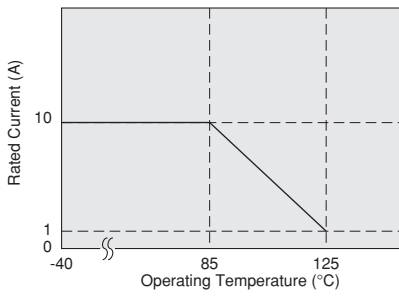

Derating of Rated Current

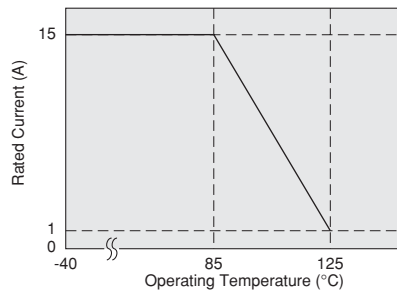

In operating temperature exceeding +85°C, derating of current is necessary for BNX024H/025H series. Please apply the derating curve shown in chart according to the operating temperature.

Derating of Rated Current

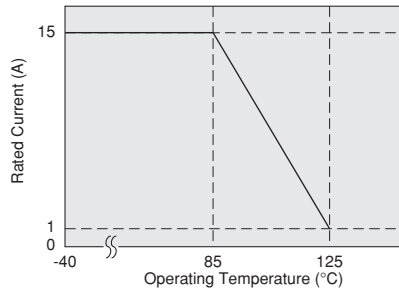

△Note • Please read rating and △CAUTION (for storage, operating, rating, soldering, mounting and handling) in this catalog to prevent smoking and/or burning, etc.
• This catalog has only typical specifications. Therefore, please approve our product specifications or transact the approval sheet for product specifications before ordering.

Chip Ferrite Bead
Chip EMIFIL®
Chip Common Mode Choke Coil
Block Type EMIFIL® Power Lines Type
Microwave Absorber

BNX00□ Series



Large insertion loss from several hundred kHz to several GHz.

BNX002/BNX003



■ Dimensions

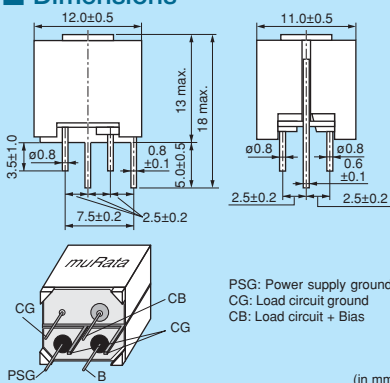

PSG: Power supply ground
CG: Load circuit ground
CB: Load circuit + Bias

(in mm)

■ Equivalent Circuit

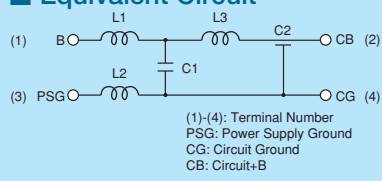

(1)-(4): Terminal Number
PSG: Power Supply Ground
CG: Circuit Ground
CB: Circuit+B

■ Packaging

Code	Packaging	Minimum Quantity
-	Box	100

BNX005



■ Dimensions

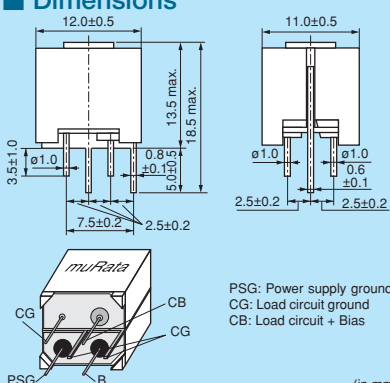

PSG: Power supply ground
CG: Load circuit ground
CB: Load circuit + Bias

(in mm)

■ Equivalent Circuit

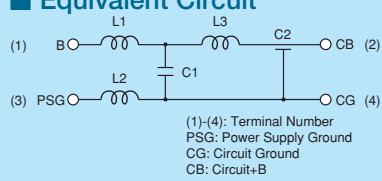

(1)-(4): Terminal Number
PSG: Power Supply Ground
CG: Circuit Ground
CB: Circuit+B

■ Packaging

Code	Packaging	Minimum Quantity
-	Box	100

Refer to pages from p.217 to p.218 for mounting information.

■ Rated Value

Part Number	Rated Voltage	Withstand Voltage	Rated Current	Insulation Resistance (min.)	Insertion Loss (20 to 25 degrees C line impedance=50 ohm)	Kit
BNX002-01	50Vdc	125Vdc	10A	100M ohm	1MHz to 1GHz:40dB min.	Kit $\geq 3A$
BNX003-01	150Vdc	375Vdc	10A	100M ohm	5MHz to 1GHz:40dB min.	Kit $\geq 3A$
BNX005-01	50Vdc	125Vdc	15A	100M ohm	1MHz to 1GHz:40dB min.	Kit $\geq 3A$

Operating Temperature Range: -30°C to +85°C

■ Insertion Loss Characteristics

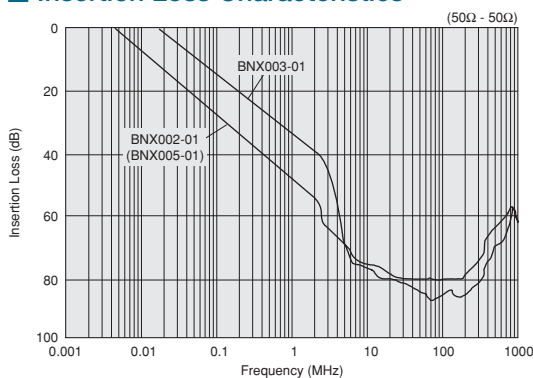

△Note • Please read rating and △CAUTION (for storage, operating, rating, soldering, mounting and handling) in this catalog to prevent smoking and/or burning, etc.
• This catalog has only typical specifications. Therefore, please approve our product specifications or transact the approval sheet for product specifications before ordering.

BNX01□ Series



Low profile version of BNX series.



Dimensions

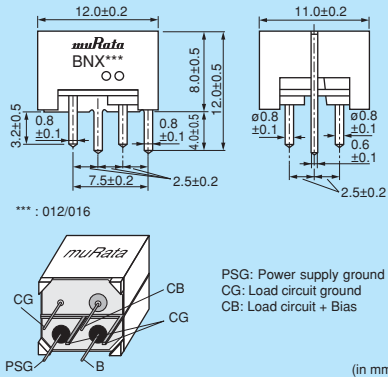

Equivalent Circuit

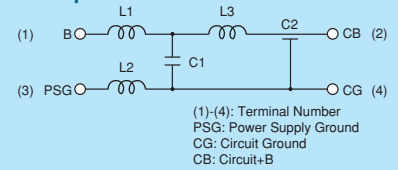

Packaging

Code	Packaging	Minimum Quantity
-	Box	150

Refer to pages from p.217 to p.218 for mounting information.

Rated Value

Part Number	Rated Voltage	Withstand Voltage	Rated Current	Insulation Resistance (min.)	Insertion Loss (20 to 25 degrees C line impedance=50 ohm)	
BNX012-01	50Vdc	125Vdc	15A	500M ohm	1MHz to 1GHz:40dB min.	Kit ≥3A
BNX016-01	25Vdc	62.5Vdc	15A	50M ohm	100kHz to 1GHz:40dB min.	Kit ≥3A

Operating Temperature Range: -40°C to +125°C

Insertion Loss Characteristics

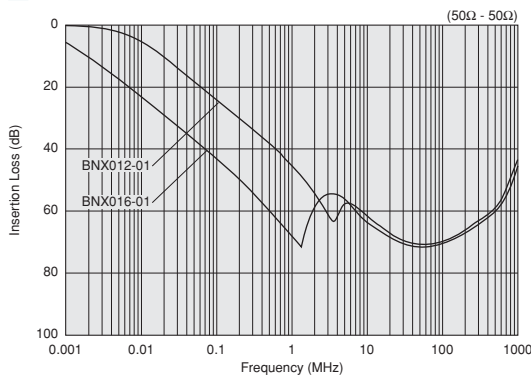

Notice (Rating)

In operating temperature exceeding +85°C, derating of current is necessary for BNX01□ series. Please apply the derating curve shown in chart according to the operating temperature.

Derating of Rated Current

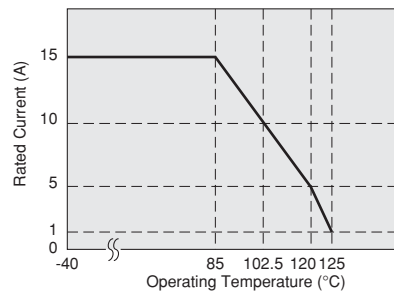

● Connecting ± power line

In case of using ± power line, please connect to each terminal as shown.

Power Supply (BNX Input)	BNX	Circuit (BNX Output)
Power Supply +Bias -	B CB	- Load Circuit +Bias
Power Supply Ground -	PSG CG	- Load Circuit Ground
Power Supply -Bias -	B CB	- Load Circuit -Bias
Power Supply Ground -	PSG CG	- Load Circuit Ground

△Note • Please read rating and △CAUTION (for storage, operating, rating, soldering, mounting and handling) in this catalog to prevent smoking and/or burning, etc.
• This catalog has only typical specifications. Therefore, please approve our product specifications or transact the approval sheet for product specifications before ordering.

Chip Ferrite Bead

Chip EMIFIL®

Chip Common Mode Choke Coil

Block Type EMIFIL® Power Lines Type

Microwave Absorber

⚠ Caution

● Rating

Do not use products beyond the rated current and rated voltage as this may create excessive heat and deteriorate the insulation resistance.

Notice

● Storage and Operating Conditions

<Operating Environment>

Do not use products in a chemical atmosphere such as chlorine gas, acid or sulfide gas.

Do not use products in the environment close to the organic solvent.

<Storage and Handling Requirements>

1. Storage Period

BNX series should be used within 12 months.
Solderability should be checked if this period is exceeded.

2. Storage Conditions

- (1) Storage temperature: -10 to +40°C
Relative humidity: 15 to 85%
Avoid sudden changes in temperature and humidity.
- (2) Do not store products in a chemical atmosphere such as chlorine gas, acid or sulfide gas.

● Notice (Soldering and Mounting)

1. Cleaning

Do not clean BNX series (SMD Type).
Before cleaning, please contact Murata engineering.

2. Soldering

Reliability decreases with improper soldering methods.
Please solder by the standard soldering conditions shown in mounting information.

3. Other

Noise suppression levels resulting from Murata's EMI suppression filters EMIFIL[®] may vary, depending on the circuits and ICs used, type of noise, mounting pattern, mounting location, and other operating conditions. Be sure to check and confirm in advance the noise suppression effect of each filter, in actual circuits, etc. before applying the filter in a commercial-purpose equipment design.

● Handling

1. Resin Coating

Using resin for coating/molding products may affect the products performance.

So please pay careful attention in selecting resin. Prior to use, please make the reliability evaluation with the product mounted in your application set.

2. Handling of a Substrate (for BNX02□)

After mounting products on a substrate, do not apply any stress to the product caused by bending or twisting to the substrate when cropping the substrate, inserting and removing a connector from the substrate or tightening screw to the substrate. Excessive mechanical stress may cause cracking in the Product.

Bending

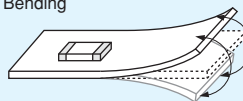

Twisting

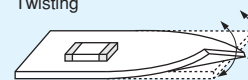

⚠ Note • Please read rating and ⚠ CAUTION (for storage, operating, rating, soldering, mounting and handling) in this catalog to prevent smoking and/or burning, etc.
• This catalog has only typical specifications. Therefore, please approve our product specifications or transact the approval sheet for product specifications before ordering.

⚠ Caution

● Rating

Do not use products beyond the rated current and rated voltage as this may create excessive heat and deteriorate the insulation resistance.

Notice

● Storage and Operating Conditions

<Operating Environment>

1. Do not use products in a chemical atmosphere such as chlorine gas, acid or sulfide gas.
2. Do not use products near water, oil or organic solvents.

<Storage and Handling Requirements>

1. Storage Period
BNX Series should be used within 12 months.
Solderability should be checked if this period is exceeded.
2. Storage Conditions
 - (1) Storage temperature: -10 to +40°C
Relative humidity: 15 to 85%
Avoid sudden changes in temperature and humidity.
 - (2) Do not store products in a chemical atmosphere such as chlorine gas, acid or sulfide gas.

● Notice (Soldering and Mounting)

1. Cleaning
Failure and degradation of a product are caused by the cleaning method. When you clean in conditions that are not in mounting information, please contact Murata engineering.
2. Soldering
Reliability decreases with improper soldering methods. Please solder by the standard soldering conditions shown in mounting information.
3. Other
Noise suppression levels resulting from Murata's EMI suppression filters "EMIFIL" may vary, depending on the circuits and ICs used, type of noise, mounting pattern, lead wire length, mounting location, and other operating conditions. Be sure to check and confirm in advance the noise suppression effect of each filter, in actual circuits, etc. before applying the filter in a commercial-purpose equipment design.

● Notice (Appearance)

Although some part of the product surface seems to be white in some cases, do not care because it is the result of waxing process for humidity resistance improvement. This wax does not make bad affection to mechanical or electrical performance, reliability of the product.

1. Standard Land Pattern Dimensions

- Land Pattern + Solder Resist
 - Land Pattern
 - Solder Resist
 - Through Hole
- (in mm)

BNX022
BNX023
BNX024
BNX025

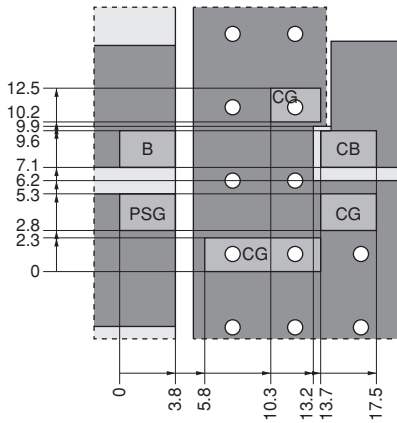

- (1) A double-sided print board (or multilayer board) as shown in the left figure is designed, and please apply a soldering Cu electrode with a product electrode to a "Land Pattern", apply resist to a "Land Pattern + Solder Resist" at Cu electrode.
- (2) This product is designed to meet large current. Please design PCB pattern which is connected to this product not to become too hot by applied large current.
- (3) Please drop CG on a ground electrode on the back layer (the same also in a multilayer case) by the through hole. And a surface to ground electrode layer may also take a large area as much as possible.
- (4) It is recommended to use a double-sided printed circuit board with BNX mounting on one side and the ground pattern on the other in order to maximize filtering performance, multiple feed through holes are required to maximize the BNX's connection to ground.
- (5) The ground pattern should be designed to be as large as possible to achieve maximum filtering performance.

● PCB Warping (for BNX02□)

PCB should be designed so that products are not subjected to the mechanical stress caused by warping the board.

Products should be located in the sideways direction (Length: a-b) to the mechanical stress.

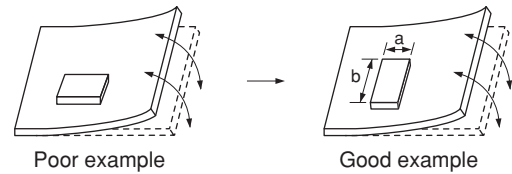

2. Solder Paste Printing and Adhesive Application

When reflow soldering the block type EMIFIL[®], the printing must be conducted in accordance with the following cream solder printing conditions.

If too much solder is applied, the chip will be prone to

damage by mechanical and thermal stress from the PCB and may crack.

Standard land dimensions should be used for resist and copper foil patterns.

Series	Solder Paste Printing	Adhesive Application
BNX022 BNX023 BNX024 BNX025	<p>●Guideline of solder paste thickness: 150-200μm</p>	

△Note • Please read rating and △CAUTION (for storage, operating, rating, soldering, mounting and handling) in this catalog to prevent smoking and/or burning, etc.
• This catalog has only typical specifications. Therefore, please approve our product specifications or transact the approval sheet for product specifications before ordering.

3. Standard Soldering Conditions

(1) Soldering Methods

Use reflow soldering methods only.
 Use standard soldering conditions when soldering block type EMIFIL® SMD type.
 In cases where several different parts are soldered, each having different soldering conditions, use those conditions requiring the least heat and minimum time.

Solder: Use Sn-3.0Ag-0.5Cu solder. Use of Sn-Zn based solder will deteriorate performance of products.

Flux:

- Use Rosin-based flux.
 In case of using RA type solder, products should be cleaned completely with no residual flux.
- Do not use strong acidic flux (with chlorine content exceeding 0.20wt%)
- Do not use water-soluble flux.

For additional mounting methods, please contact Murata.

(2) Soldering Profile

- Reflow Soldering Profile (Sn-3.0Ag-0.5Cu solder)

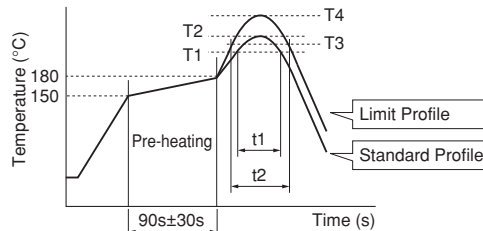

Series	Standard Profile				Limit Profile			
	Heating		Peak Temperature (T2)	Cycle of Reflow	Heating		Peak Temperature (T4)	Cycle of Reflow
	Temp. (T1)	Time. (t1)			Temp. (T3)	Time. (t2)		
BNX022/023/024/025	220°C min.	30 to 60s	250±3°C	2 times max.	230°C min.	60s max.	260°C/10s	2 times max.

(3) Reworking with Solder Iron

The following conditions must be strictly followed when using a soldering iron.
 Pre-heating: 150°C 60s min.
 Soldering iron power output: 100W max.
 Temperature of soldering iron tip / Soldering time / Times:
 450°C max. / 5s max. / 2 time

Do not allow the tip of the soldering iron to directly contact the chip.
 For additional methods of reworking with a soldering iron, please contact Murata engineering.

4. Cleaning

Do not clean BNX022/023/024/025 series. In case of cleaning, please contact Murata engineering.

△Note • Please read rating and △CAUTION (for storage, operating, rating, soldering, mounting and handling) in this catalog to prevent smoking and/or burning, etc.
 • This catalog has only typical specifications. Therefore, please approve our product specifications or transact the approval sheet for product specifications before ordering.

1. Mounting Hole

■ Mounting holes should be designed as specified below.

BNX00□/01□

Component Side

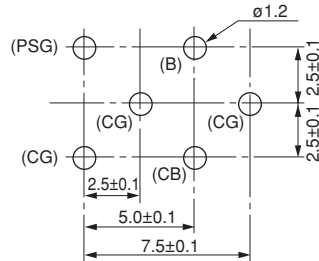

Terminal Layout (Bottom figure)

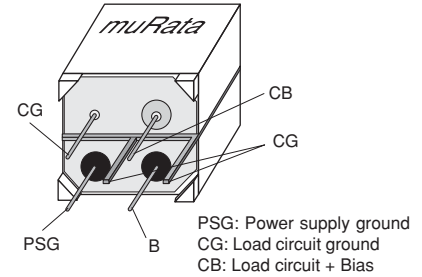

2. Using the Block Type EMIFIL® (Lead Type) Effectively

(1) How to use effectively

This product effectively prevents undesired radiation and external noise from going out / entering the circuit by grounding the high frequency components which cause noise problems. Therefore, grounding conditions may affect the performance of the filter and attention should be paid to the following for effective use.

- Design maximized grounding area in the P.C. board, and grounding pattern for all the grounding terminals of the product to be connected. (Please follow the specified recommendations.)
- Minimize the distance between ground of the P.C. board and the ground plate of the product. (Recommend using the through hole connection between grounding area both of component side and bottom side.)
- Insert the terminals into the holes on P.C. board completely.
- Don't connect PSG terminal with CG terminal directly. (See the item 1. Terminal Layout)

(2) Self-heating

Though this product has a large rated current, localized self-heating may be caused depending on soldering conditions. To avoid this, attention should be paid to the following:

- Use P.C. board with our recommendation on hole diameter / land pattern dimensions, mentioned in the right hand drawing, especially for 4 terminals which pass current.
- Solder the terminals to the P.C. board with soldercover area at least 90%. Otherwise, excess self-heating at connection between terminals and P.C. board may lead to smoke and / or fire of the product even when operating at rated current.
- After installing this product in your product, please make sure the self-heating is within the rated current recommended.

P. C. Board Patterns

Use a bilateral P.C. board. Insert the BNX into the P.C.board until the root of the terminal is secured, then solder.

(1) Component Side View

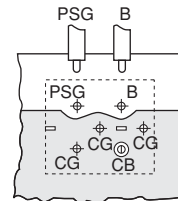

(2) Bottom View

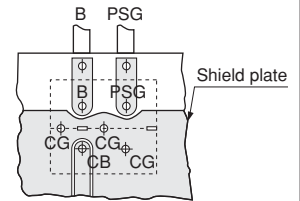

Legend: Copper foil pattern

Recommended Land Pattern

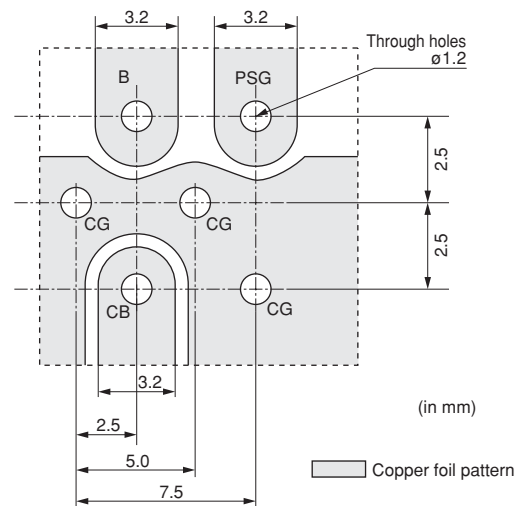

△Note • Please read rating and △CAUTION (for storage, operating, rating, soldering, mounting and handling) in this catalog to prevent smoking and/or burning, etc.
• This catalog has only typical specifications. Therefore, please approve our product specifications or transact the approval sheet for product specifications before ordering.

3. Soldering

- (1) Use Sn-3.0Ag-0.5Cu solder.
- (2) Use Rosin-based flux. Do not use strong acidic flux with halide content exceeding 0.2wt% (chlorine conversion value).
- (3) Products and the leads should not be subjected to any mechanical stress during the soldering process, or while subjected to the equivalent high temperatures.
- (4) Standard flow soldering profile

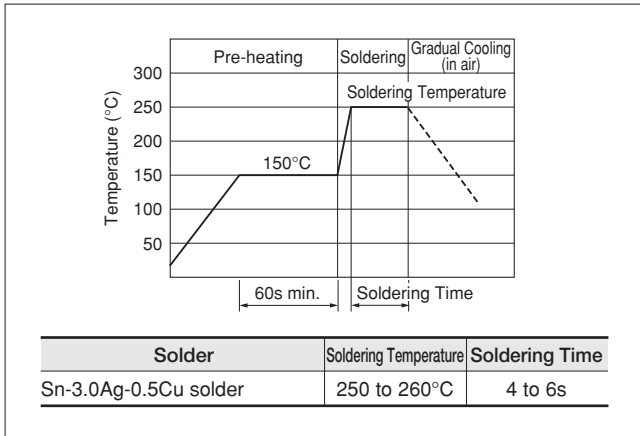

4. Cleaning

Clean the block Type EMIFIL®(Lead Type) in the following conditions.

- (1) Cleaning temperature should be limited to 60°C max. (40°C max for alcohol type cleaner).
- (2) Ultrasonic cleaning should comply with the following conditions, avoiding the resonance phenomenon at the mounted products and P.C.B.
 Power: 20W/liter max.
 Frequency: 28 to 40kHz
 Time: 5 min. max.
- (3) Cleaner
 - (a) Alcohol type cleaner
Isopropyl alcohol (IPA)
 - (b) Aqueous agent
Pine Alpha ST-100S

- (4) There should be no residual flux or residual cleaner left after cleaning.
 In the case of using aqueous agent, products should be dried completely after rinsing with de-ionized water in order to remove the cleaner.
- (5) The surface of products may become dirty after cleaning, but there is no deterioration on mechanical, electrical characteristics and reliability.
- (6) Other cleaning: Please contact us.

⚠️Note • Please read rating and ⚠️CAUTION (for storage, operating, rating, soldering, mounting and handling) in this catalog to prevent smoking and/or burning, etc.
 • This catalog has only typical specifications. Therefore, please approve our product specifications or transact the approval sheet for product specifications before ordering.

Chip Ferrite Bead

Chip EMIFIL®

Chip Common Mode Choke Coil

Soldering and Mounting
 Block Type EMIFIL®

Microwave Absorber

Minimum Quantity and Dimensions of 24mm Width Embossed Tape

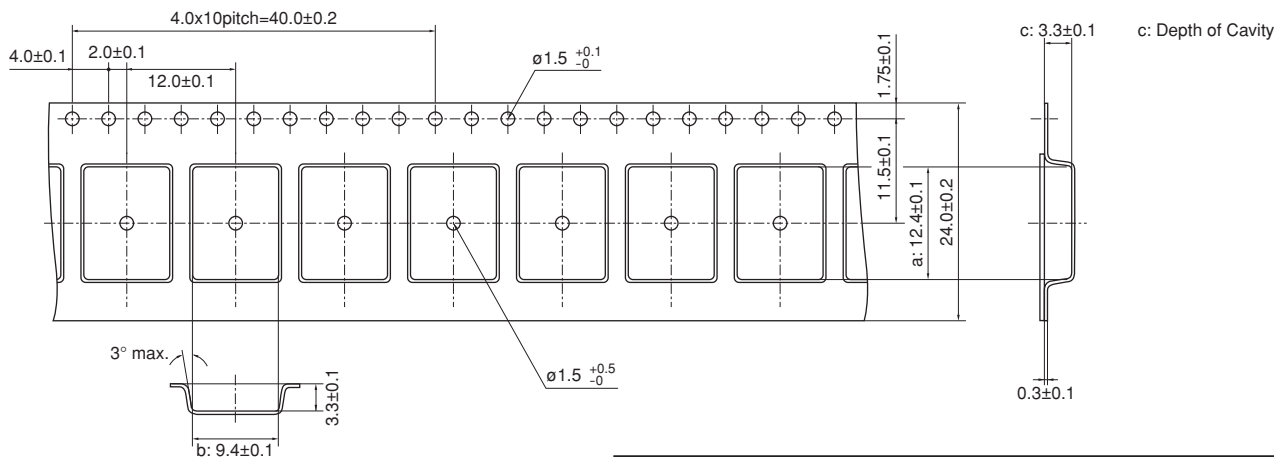

Dimension of the cavity is measured at the bottom side.

Part Number	Dimensions			Minimum Qty. (pcs.)		
	a	b	c	ø180mm Reel	ø330mm Reel	Bulk
BNX022/023	12.4	9.4	3.3	400	1500	100

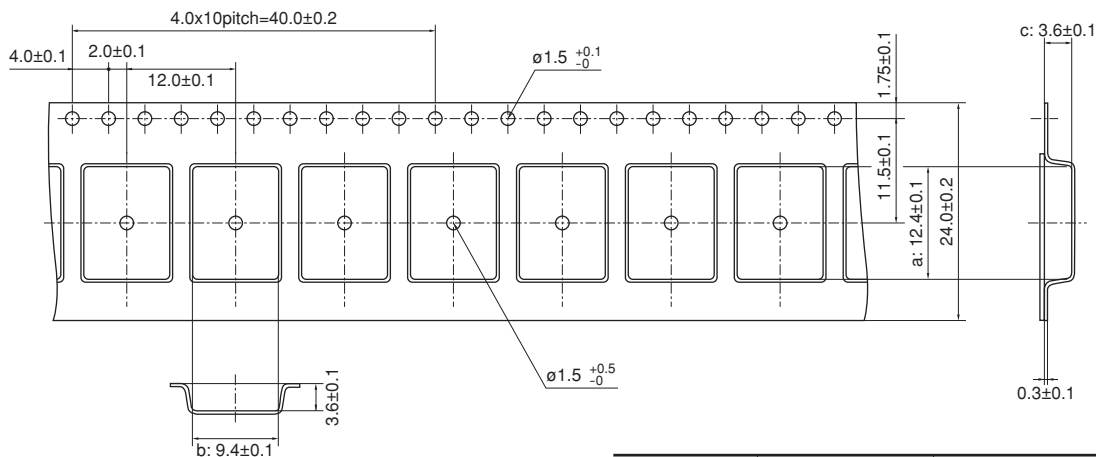

Dimension of the cavity is measured at the bottom side.

Part Number	Dimensions			Minimum Qty. (pcs.)		
	a	b	c	ø180mm reel	ø330mm reel	Bulk
BNX024/025	12.4	9.4	3.6	400	1500	100

(in mm)

"Minimum Quantity" means the number of units of each delivery or order. The quantity should be an integral multiple of the "Minimum Quantity."

Note • Please read rating and **CAUTION** (for storage, operating, rating, soldering, mounting and handling) in this catalog to prevent smoking and/or burning, etc.
• This catalog has only typical specifications. Therefore, please approve our product specifications or transact the approval sheet for product specifications before ordering.

BNX Block Type EMIFIL® Design Kits



●EKEPBLCKD

No.	Part Number	Quantity (pcs.)	Common Mode Impedance (at 10MHz, 20 degrees C)	Rated Voltage (Vdc)	Rated Current (A)
1	PLT10HH450180PN	2	45Ω (Typ.)	300	18
2	PLT10HH101150PN	2	100Ω (Typ.)	300	15
3	PLT10HH401100PN	2	400Ω (Typ.)	100	10
4	PLT10HH501100PN	2	500Ω (Typ.)	100	10
5	PLT10HH9016R0PN	2	900Ω (Typ.)	100	6
6	PLT10HH1026R0PN	2	1000Ω (Typ.)	100	6

No.	Part Number	Quantity (pcs.)	Insertion Loss	Rated Voltage (Vdc)	Rated Current (A)
7	BNX002-01	1	1MHz to 1GHz : 40dB min.	50	10
8	BNX003-01	1	5MHz to 1GHz : 40dB min.	150	10
9	BNX005-01	1	1MHz to 1GHz : 40dB min.	50	15
10	BNX012-01	1	1MHz to 1GHz : 40dB min.	50	15
11	BNX016-01	1	100kHz to 1GHz : 40dB min.	25	15
12	BNX022-01	2	1MHz to 1GHz : 35dB min.	50	10
13	BNX023-01	2	1MHz to 1GHz : 35dB min.	100	15
14	BNX024H01	2	100kHz to 1GHz : 35dB min.	50	15
15	BNX025H01	2	50kHz to 1GHz : 35dB min.	25	15

△Note • Please read rating and △CAUTION (for storage, operating, rating, soldering, mounting and handling) in this catalog to prevent smoking and/or burning, etc.
 • This catalog has only typical specifications. Therefore, please approve our product specifications or transact the approval sheet for product specifications before ordering.



Microwave Absorber

Part Numbering	222
Product Detail	223
Notice	226

Chip Ferrite Bead

Chip EMIFIL®

Chip Common Mode Choke Coil

Block Type EMIFIL®

Microwave Absorber

⚠Note • Please read rating and ⚠CAUTION (for storage, operating, rating, soldering, mounting and handling) in this catalog to prevent smoking and/or burning, etc.
• This catalog has only typical specifications. Therefore, please approve our product specifications or transact the approval sheet for product specifications before ordering.

EA Microwave Absorber Part Numbering

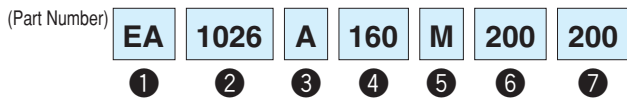

① Product ID

Product ID	
EA	Microwave Absorber

② Sheet Type

Code	Sheet Type
10□□	Iron carbonyl type (UL certified type/Halogen Free type)
2070	Metal Flake Powder (Halogen Free type)
2100	Metal Flake Powder (UL certified type)
3008	Magnetic material (UL certified type/Halogen Free type)

③ Adhesive Tape Type

Code	Adhesive Tape Type
A	Standard tape type (Halogen Free type)
B	Thin Adhesive tape type (Halogen Free type)
L	No tape type
U	UL certified type (Halogen Free type)

④ Sheet Thickness

Expressed by 3 digits including the second decimal place in mm.

Ex.)

Code	Sheet Thickness
020	0.20mm

⑤ Unit of Dimension

One capital letter expresses Unit of Dimension (⑥) and Dimensions Length (⑦).

Code	Unit of Dimension
M	in mm (Standard)
C	in cm (Standard)

Standard shape is a rectangle.

Please contact us for other shapes.

⑥ Dimension (Length)

Expressed by 3 digits including the first decimal place.

⑦ Dimension (Width)

Expressed by 3 digits including the first decimal place.

Ex.)

Code	Dimension (Length × Width)
M300150	30.0×15.0 mm
C150100	15.0×10.0 cm

△Note • Please read rating and △CAUTION (for storage, operating, rating, soldering, mounting and handling) in this catalog to prevent smoking and/or burning, etc.
• This catalog has only typical specifications. Therefore, please approve our product specifications or transact the approval sheet for product specifications before ordering.

EA10 Series

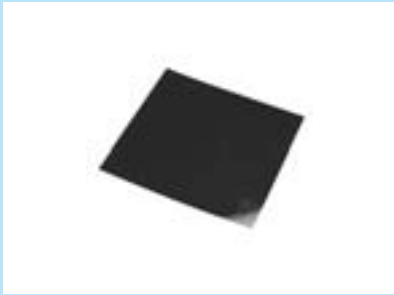

■ Packaging

When inquiring, please contact us with size code, referring to "Part Numbering."

■ Rated Value

Part Number	Applicable Frequency (Typ.)	Thickness (Typ.)	Flame Class	Halogen	Operating Temperature Range
EA1026A100	20.0GHz	1.0mm	UL94V-0	Halogen Free	-40°C to +80°C
EA1026A160	11.5GHz	1.6mm	UL94V-0	Halogen Free	-40°C to +80°C
EA1026A180	10.0GHz	1.8mm	UL94V-0	Halogen Free	-40°C to +80°C
EA1046A180	5.8GHz	1.8mm	UL94V-0	Halogen Free	-40°C to +80°C
EA1075A270	2.5GHz	2.7mm	UL94V-0	Halogen Free	-40°C to +80°C

■ Reflection Loss (Typ.)

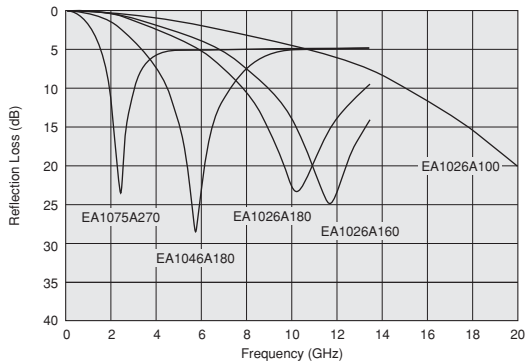

Chip Ferrite Bead

Chip EMIFIL®

Chip Common Mode Choke Coil

Block Type EMIFIL®

Microwave Absorber

⚠Note • Please read rating and ⚠CAUTION (for storage, operating, rating, soldering, mounting and handling) in this catalog to prevent smoking and/or burning, etc.
 • This catalog has only typical specifications. Therefore, please approve our product specifications or transact the approval sheet for product specifications before ordering.

EA20/EA21 Series



■ Packaging

When inquiring, please contact us with size code, referring to "Part Numbering."

■ Rated Value

Part Number	Applicable Frequency (Typ.)	Thickness (Typ.)	Flame Class	Halogen	Operating Temperature Range
EA2070A020	0.1 to 3.0GHz	0.20mm	-	Halogen Free	-40°C to +120°C
EA2070A050	0.1 to 3.0GHz	0.50mm	-	Halogen Free	-40°C to +120°C
EA2070A100	0.1 to 3.0GHz	1.00mm	-	Halogen Free	-40°C to +120°C
EA2070B005	0.1 to 3.0GHz	0.05mm	-	Halogen Free	-40°C to +120°C
EA2070B010	0.1 to 3.0GHz	0.10mm	-	Halogen Free	-40°C to +120°C
EA2070B013	0.1 to 3.0GHz	0.13mm	-	Halogen Free	-40°C to +120°C
EA2070B020	0.1 to 3.0GHz	0.20mm	-	Halogen Free	-40°C to +120°C
EA2070B050	0.1 to 3.0GHz	0.50mm	-	Halogen Free	-40°C to +120°C
EA2100A020	0.1 to 3.0GHz	0.20mm	UL94V-0	-	-40°C to +120°C
EA2100A050	0.1 to 3.0GHz	0.50mm	UL94V-0	-	-40°C to +120°C
EA2100A100	0.1 to 3.0GHz	1.00mm	UL94V-0	-	-40°C to +120°C
EA2100B020	0.1 to 3.0GHz	0.20mm	UL94V-0	-	-40°C to +120°C
EA2100B050	0.1 to 3.0GHz	0.50mm	UL94V-0	-	-40°C to +120°C
EA2100B100	0.1 to 3.0GHz	1.00mm	UL94V-0	-	-40°C to +120°C

■ Magnetic Permeability-Reluctance

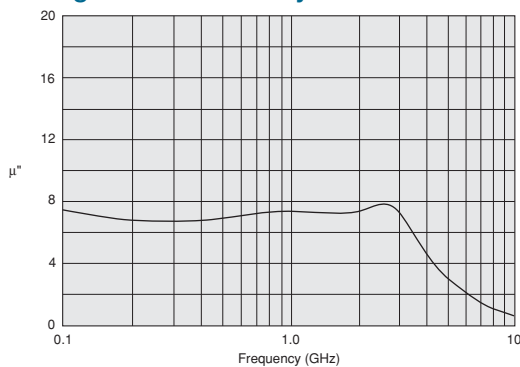

⚠Note • Please read rating and ⚠CAUTION (for storage, operating, rating, soldering, mounting and handling) in this catalog to prevent smoking and/or burning, etc.
 • This catalog has only typical specifications. Therefore, please approve our product specifications or transact the approval sheet for product specifications before ordering.

Chip Ferrite Bead

Chip EMIFIL®

Chip Common Mode Choke Coil

Block Type EMIFIL®

Microwave Absorber

EA30 Series



■ Packaging

When inquiring, please contact us with size code, referring to "Part Numbering."

■ Rated Value

Part Number	Applicable Frequency (Typ.)	Thickness (Typ.)	Flame Class	Halogen	Operating Temperature Range
EA3008U025	0.1 to 3.0GHz	0.25mm	UL94V-0	Halogen Free	-40°C to +120°C
EA3008U035	0.1 to 3.0GHz	0.35mm	UL94V-0	Halogen Free	-40°C to +120°C
EA3008U050	0.1 to 3.0GHz	0.50mm	UL94V-0	Halogen Free	-40°C to +120°C
EA3008U100	0.1 to 3.0GHz	1.00mm	UL94V-0	Halogen Free	-40°C to +120°C
EA3008U250	0.1 to 3.0GHz	2.50mm	UL94V-0	Halogen Free	-40°C to +120°C

■ Magnetic Permeability-Reluctance

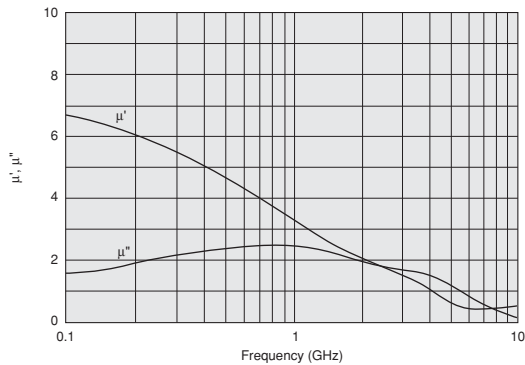

⚠Note • Please read rating and ⚠CAUTION (for storage, operating, rating, soldering, mounting and handling) in this catalog to prevent smoking and/or burning, etc.
 • This catalog has only typical specifications. Therefore, please approve our product specifications or transact the approval sheet for product specifications before ordering.

Notice

● Storage and Operating Conditions

1. Adhesive Tape Stress

This product is designed to use adhesive tape to hold itself to the object.

And please avoid causing mechanical stress by bending or variation of the object.

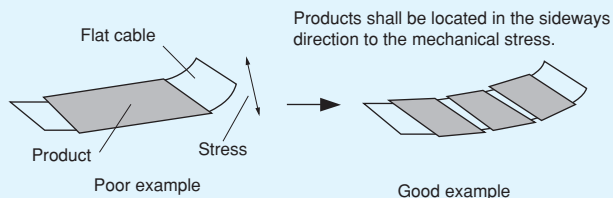

2. Cleaning

Avoid cleaning this product.

3. Handling of the Product

Adhesive tape must be clean to maintain the quality of adhesion.

Please wipe off any dirt, dust and any kind of oil from the surface of the object before use.

4. Storage Conditions

(1) Storage period

Products that were inspected by Murata over 6 months ago should be examined and used. This can be confirmed by the inspection No. marked on the container.

Adhesiveness should be checked if this period is exceeded.

(2) Storage conditions

· Products should be stored in the warehouse in the following conditions:

Temperature: -10 to +40°C

Humidity: 30 to 70% relative humidity

No rapid change of temperature or humidity

· Products should be stored in the warehouse without heat shock condition, vibration, direct sunlight and so on.

Product Guide by Size

Which Size? inch (mm)	Inductor Type	Capacitor Type			Common Mode Choke Coils	Block Type L×W×T(mm)
		Simple Capacitor	LC(RC) Combined	T Circuit Filter Feed Through Type		
01005 (0402)	BLM02A ^{p23}					12×11×max13 ^{p211} BNX002-01 BNX003-01 Lead
0201 (0603)	BLM03AG ^{p30} BLM03AX ^{p28} BLM03B ^{p32} BLM03E ^{p84} BLM03P ^{p25} BLM03H ^{p82}					
025020 (0605)					DLP0QS ^{p176}	12×11×max13.5 ^{p211} BNX005-01 Lead
03025 (0806)					DLP0NS ^{p177}	
0402 (1005)	BLM15AG ^{p40} BLM15AX ^{p38} BLM15B ^{p42} BLM15HD ^{p85} BLM15P ^{p34} BLM15HB ^{p85} BLM15EG ^{p87} BLM15GG ^{p88} BLM15HG ^{p85} BLM15GA ^{p88}		NFL15ST ^{p132}			12×11×max8.5 ^{p212} BNX012-01 BNX016-01 Lead
05025 (1506)					DLP1ND ^{p183}	
0504 (1210)					DLM11G ^{p174} DLM11S ^{p175} DLP11S/11R/11T ^{p179} ^{p180} ^{p181}	9.1×12.1×max3.3 ^{p209} BNX022-01 BNX023-01 SMD
0603 (1608)	BLM18A ^{p54} BLM18EG ^{p93} BLM18T ^{p60} BLM18HE ^{p89} BLM18B ^{p56} BLM18HG ^{p89} BLM18R ^{p61} BLM18HD ^{p89} BLM18P ^{p48} BLM18HB ^{p89} BLM18K ^{p50} BLM18HK ^{p89} BLM18S ^{p52} BLM18GG ^{p95}	NFM18C ^{p127} NFM18P ^{p118} ^{p119}	NFL18ST ^{p133} ^{p134} NFL18SP ^{p135}			
Array			NFA18S ^{p137} ^{p138} ^{p139}			9.1×12.1×max3.7 ^{p209} BNX024H01 BNX025H01 SMD
0804 (2010) Array	BLA2AA ^{p77} BLA2AB ^{p77}				DLP2AD ^{p184}	
0805 (2012) Array	BLM21A ^{p66} BLM21R ^{p71} BLM21B ^{p68} BLM21P ^{p64}	NFM21C ^{p128} NFM21P ^{p121} ^{p122}	NFL21S ^{p136} NFR21G ^{p144} NFA21S ^{p140} ^{p141}		DLW21S ^{p187} DLW21H ^{p189}	
1205 (3212)		NFM3DC ^{p129} NFM3DP ^{p123}				
1206 (3216) Array	BLM31P ^{p73} BLA31A ^{p80} BLA31B ^{p80}	NFM31P ^{p124} NFM31K ^{p125}	NFW31S ^{p142} NFA31C ^{p131} NFA31G ^{p145}	NFE31P ^{p116}	DLP31S ^{p182} DLW31S ^{p190} DLP31D ^{p186}	
1806 (4516)	BLM41P ^{p75}	NFM41C ^{p130} NFM41P ^{p126}				
2014 (5036)					DLW5AH ^{p167} DLW5AT ^{p169} ^{p171}	
2020 (5050)					DLW5BS ^{p167} DLW5BT ^{p169} ^{p171}	
2606 (6816)				NFE61P ^{p117}		

△Note • Please read rating and △CAUTION (for storage, operating, rating, soldering, mounting and handling) in this catalog to prevent smoking and/or burning, etc.
• This catalog has only typical specifications. Therefore, please approve our product specifications or transact the approval sheet for product specifications before ordering.

Part Number Quick Reference

BL□ Series

BLA2AA	p77
BLA2AB	p77
BLA31A	p80
BLA31B	p80
BLM02AX	p23
BLM03AG	p30
BLM03AX	p28
BLM03B	p32
BLM03E	p84
BLM03H	p82
BLM03PG	p25
BLM03PX	p26
BLM15AG	p40
BLM15AX	p38
BLM15B	p44
BLM15BX	p42
BLM15EG	p87
BLM15GA	p88
BLM15GG	p88
BLM15HB	p85
BLM15HD	p85
BLM15HG	p85
BLM15PG/PD	p36
BLM15PX	p34
BLM18A	p54
BLM18B	p56
BLM18EG	p93
BLM18GG	p95
BLM18HB	p89
BLM18HD	p89
BLM18HE	p89
BLM18HG	p89
BLM18HK	p89
BLM18K	p50
BLM18P	p48
BLM18R	p61
BLM18S	p52
BLM18T	p60
BLM21A	p66
BLM21B	p68
BLM21P	p64
BLM21R	p71
BLM31P	p73
BLM41P	p75

NF□ Series

NFA18SD	p139
NFA18SL	p137
NFA21SL	p140
NFA31C	p131
NFA31G	p145
NFE31P	p116
NFE61P	p117
NFL15ST	p132
NFL18SP	p135
NFL18ST	p133
NFL21SP	p136
NFM18C	p127
NFM18PC	p119
NFM18PS	p118
NFM21C	p128
NFM21PC	p122
NFM21PS	p121
NFM31K	p125
NFM31P	p124
NFM3DC	p129
NFM3DP	p123
NFM41C	p130
NFM41P	p126
NFR21G	p144
NFW31S	p142

DL□ (PL□) Series

DLM11G	p174
DLM11S	p175
DLP0NS	p177
DLP0QS	p176
DLP11S/11R/11T	p179
DLP1ND	p183
DLP2AD	p184
DLP31D	p186
DLP31S	p182
DLW21H	p189
DLW21S	p187
DLW31S	p190
DLW5AH	p167
DLW5AT	p169
DLW5BS	p167
DLW5BT	p169
PLT10H	p191

BNX Series

BNX002	p211
BNX003	p211
BNX005	p211
BNX012	p212
BNX016	p212
BNX022	p209
BNX023	p209
BNX024	p209
BNX025	p209

EA Series

EA10	p223
EA20	p224
EA21	p224
EA30	p225

Alphabetic Product Name Index

3 Terminal Filter	p107	Chip EMIFIL® LC Combined Type Array	p137
Block Type EMIFIL® LC Combined Type	p209	Chip EMIFIL® LC Combined Wire Wound Type	p142
Chip Common Mode Choke Coil Film Type	p176	Chip EMIFIL® RC Combined Type	p144.145
Chip Common Mode Choke Coil Film Type Array	p184	Chip EMIFIL® RC Combined Type Array	p145
Chip Common Mode Choke Coil Multilayer Type	p174	Chip Ferrite Bead	p13
Chip Common Mode Choke Coil Wire Wound Type	p187	Chip Ferrite Bead Array	p77
Chip Common Mode Choke Coil Wire Wound Type For Large Current	p167	Chip Ferrite Bead For GHz Band Noise	p82
Chip EMIFIL® Array	p77.80.131.137.140.145	Chip Ferrite Bead For High-GHz Band Noise	p88
Chip EMIFIL® Capacitor Type	p107	Common Mode Filter	p159
Chip EMIFIL® Capacitor Type Array	p131	EMIFIL®	p13.107.159.205
Chip EMIFIL® Feed Through Type	p116	EMI Suppression Filter	p13.107.159.205
Chip EMIFIL® For Large Current	p25.116.118.167.209	LC Combined L Circuit Array	p137
Chip EMIFIL® Inductor Type	p13	L Circuit Filter	p137
Chip EMIFIL® LC Combined Multilayer Type	p132	Microwave Absorber	p221
Chip EMIFIL® LC Combined T Circuit Type	p116.132	PI Circuit Filter	p135.136.142
Chip EMIFIL® LC Combined Type	p116	T Circuit Filter	p116.132

⚠Note • Please read rating and ⚠CAUTION (for storage, operating, rating, soldering, mounting and handling) in this catalog to prevent smoking and/or burning, etc.
• This catalog has only typical specifications. Therefore, please approve our product specifications or transact the approval sheet for product specifications before ordering.

Please refer to catalogs below for ferrite cores, Microwave Absorber and leaded EMIFIL®.

Ferrite Core, Microwave Absorber

Ferrite Core for EMI Suppression Microwave Absorber

Contents Thin Type Sandwich Core <FSSA>
Core for Flat Cables <FSRC>
Beads Core <FSRH>
Ring Core <FSRB>
Microwave Absorber <EA>

This Catalog is PDF version only. Please refer to following URL.
<http://www.murata.com/products/catalog/pdf/o63e.pdf>

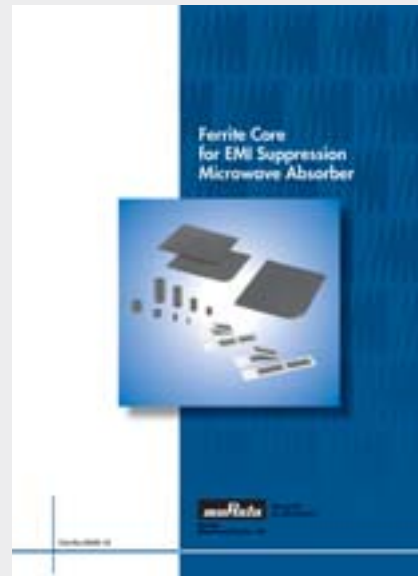

Lead Type EMIFIL®

EMI Suppression Filters (Lead Type EMIFIL®)

Contents Ferrite Beads Inductors <BL01/02/03>
Disc Type EMIFIL® <DS□6/DS□9>
EMIGUARD® (EMIFIL® with Varistor Function)
<VF□3/VF□6/VF□9>
Common Mode Choke Coils <PLT>



EMICON-FUN!

Please check Murata's newsletter!
 You can learn about electric parts with fun.
http://www.murata.com/products/emicon_fun/

EMICON-FUN! disseminated widely from basics (principles, characteristics, mounting, etc.) of capacitors, EMI suppression filters and inductors to information can practically be used.
 Updated information is also distributed via the mail magazine.

Click here to register as reader → <https://fofa.jp/murata/a.p/107/>

You can register from Murata Manufacturing Web site page TOP.
<http://www.murata.com/products/>



← This banner is the entrance of register form

△Note • Please read rating and △CAUTION (for storage, operating, rating, soldering, mounting and handling) in this catalog to prevent smoking and/or burning, etc.
 • This catalog has only typical specifications. Therefore, please approve our product specifications or transact the approval sheet for product specifications before ordering.

⚠Note:

1. Export Control

<For customers outside Japan>

No Murata products should be used or sold, through any channels, for use in the design, development, production, utilization, maintenance or operation of, or otherwise contribution to (1) any weapons (Weapons of Mass Destruction [nuclear, chemical or biological weapons or missiles] or conventional weapons) or (2) goods or systems specially designed or intended for military end-use or utilization by military end-users.

<For customers in Japan>

For products which are controlled items subject to the "Foreign Exchange and Foreign Trade Law" of Japan, the export license specified by the law is required for export.

2. Please contact our sales representatives or product engineers before using the products in this catalog for the applications listed below, which require especially high reliability for the prevention of defects which might directly damage a third party's life, body or property, or when one of our products is intended for use in applications other than those specified in this catalog.

- | | |
|-----------------------------|--|
| ① Aircraft equipment | ② Aerospace equipment |
| ③ Undersea equipment | ④ Power plant equipment |
| ⑤ Medical equipment | ⑥ Transportation equipment (vehicles, trains, ships, etc.) |
| ⑦ Traffic signal equipment | ⑧ Disaster prevention / crime prevention equipment |
| ⑨ Data-processing equipment | ⑩ Application of similar complexity and/or reliability requirements to the applications listed above |

3. Product specifications in this catalog are as of March 2013. They are subject to change or our products in it may be discontinued without advance notice.

Please check with our sales representatives or product engineers before ordering. If there are any questions, please contact our sales representatives or product engineers.

4. Please read rating and ⚠CAUTION (for storage, operating, rating, soldering, mounting and handling) in this catalog to prevent smoking and/or burning, etc.

5. This catalog has only typical specifications. Therefore, please approve our product specifications or transact the approval sheet for product specifications before ordering.

6. Please note that unless otherwise specified, we shall assume no responsibility whatsoever for any conflict or dispute that may occur in connection with the effect of our and/or a third party's intellectual property rights and other related rights in consideration of your use of our products and/or information described or contained in our catalogs. In this connection, no representation shall be made to the effect that any third parties are authorized to use the rights mentioned above under licenses without our consent.

7. No ozone depleting substances (ODS) under the Montreal Protocol are used in our manufacturing process.

 **Murata Manufacturing Co., Ltd.**

<http://www.murata.com/>

Head Office

1-10-1, Higashi Kotari, Nagaokakyo-shi, Kyoto 617-8555, Japan
Phone: 81-75-951-9111

International Division

3-29-12, Shibuya, Shibuya-ku, Tokyo 150-0002, Japan
Phone: 81-3-5469-6123 Fax: 81-3-5469-6155 E-mail: intl@murata.co.jp

Cat. No. C31E-25