

Search by Part Number

Search by Specifications

Search in the Lineups

Search by Competitor's Part Number

Home > Products > Capacitors > Ceramic Capacitors > Product details  

## Chip Monolithic Ceramic Capacitors for General Purpose

▶ Please be sure to read here, before using a product. ▶ Cautions about imitations

# GRM1885C1H331JA01#

"#" indicates a package specification code.

**Recommended** In Production  [▶ Smaller items available](#)

**General** **125**   **RoHS** **REACH** 

< List of part numbers with package codes >  
GRM1885C1H331JA01D、GRM1885C1H331JA01J

## Shape

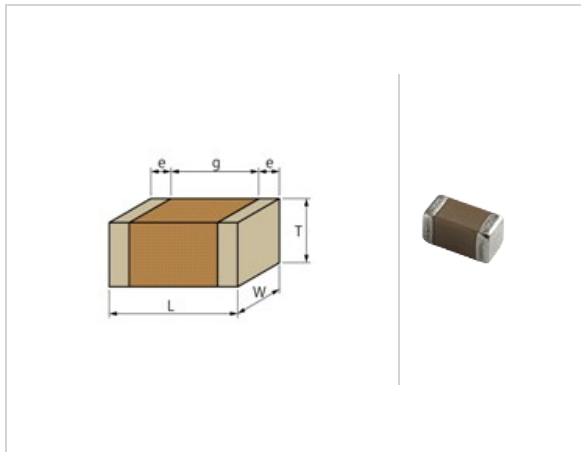

L size	1.6 ±0.1mm
W size	0.8 ±0.1mm
T size	0.8 ±0.1mm
External terminal width e	0.2 to 0.5mm
Distance between external terminals g	0.5mm min.
Size code in inch(mm)	0603 (1608M)

## Specifications

Capacitance	330pF ±5%
Rated voltage	50Vdc
Temperature characteristics (complied standard)	COG(EIA)
Temperature coefficient	0±30ppm/°C
Temperature range of temperature characteristics	25 to 125°C
Operating temperature range	-55 to 125°C

## References

Packaging	Specifications	Minimum quantity
D	φ180mm Paper taping	4000
J	φ330mm Paper taping	10000

Mass (typ.)	
1 piece	6.3mg

**20pcs free sample request** 

**Stock Check (Where to buy)** 

**PDF Catalogs**

**Download a PDF file of this page** 

How to read part numbers 

Series Information 

**Specifications**

Detailed specifications sheet 

- Rated value
- Specifications and Test methods
- Package
- Caution, Notice (Storage, Soldering and Mounting, ...etc.)

**Product data**



SPICE Netlist (mod type) 

S parameter (S2P type) 

Reliability test data (Typical data) 

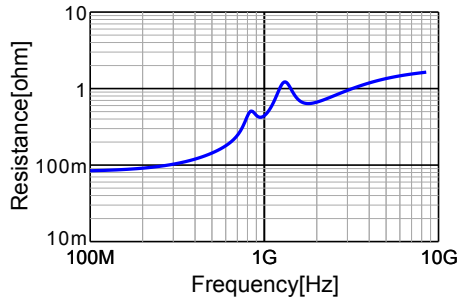
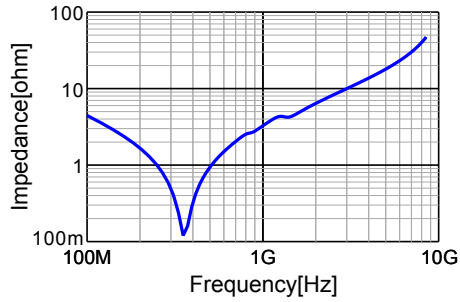
### Chart of characteristic data



 [Go to the detailed chart](#) 

[Top of page](#)