



GRM21BR61C475KA88#

" # " indicates a package specification code.

Available   Complies with RoHS

< List of part numbers with package codes >
GRM21BR61C475KA88L , GRM21BR61C475KA88K

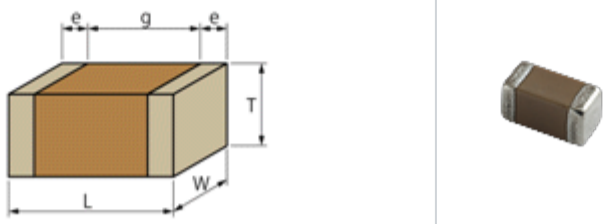
Shape

L size	2.0 ± 0.1mm
W size	1.25 ± 0.1mm
T size	1.25 ± 0.1mm
External terminal width e	0.2 to 0.7mm
Distance between external terminals g	0.7mm min.
Size code in inch(mm)	0805 (2012)

References

Packaging	Specifications	Minimum quantity
L	180mm Embossed taping	3000
K	330mm Embossed taping	10000

Mass (typ.)	
1 piece	17mg
180mm Reel	102g

Specifications

Capacitance	4.7µF ± 10%
Rated voltage	16Vdc
Temperature characteristics (complied standard)	X5R(EIA)
Capacitance change rate	± 15.0%
Temperature range of temperature characteristics	-55 to 85
Operating temperature range	-55 to 85

Attention

- 1.This datasheet is downloaded from the website of Murata Manufacturing Co., Ltd. Therefore, it ' s specifications are subject to change or our products in it may be discontinued without advance notice. Please check with our sales representatives or product engineers before ordering.
- 2.This datasheet has only typical specifications because there is no space for detailed specifications. Therefore, please review our product specifications or consult the approval sheet for product specifications before ordering.

▪ Frequency characteristics (ESR, Impedance)

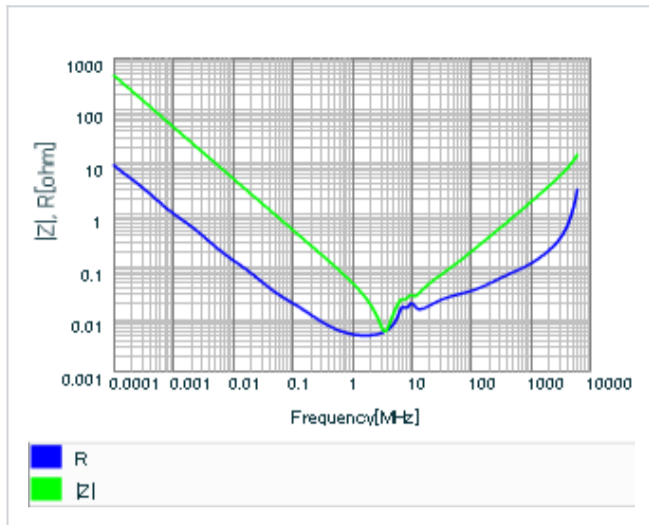

▪ S parameter (Smith chart S11)

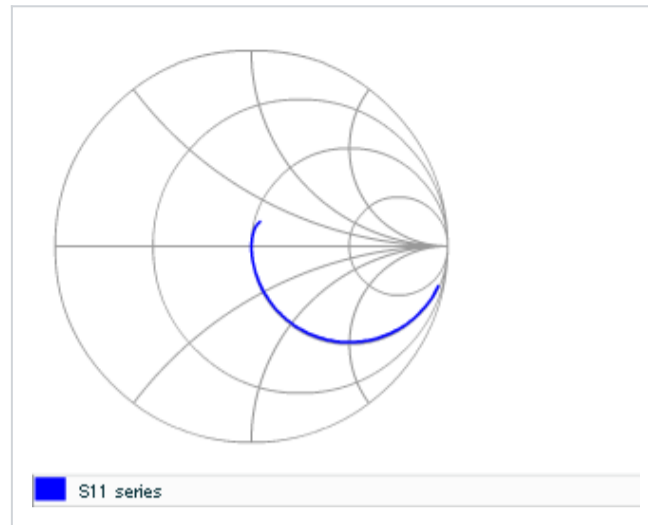

▪ DC bias characteristics

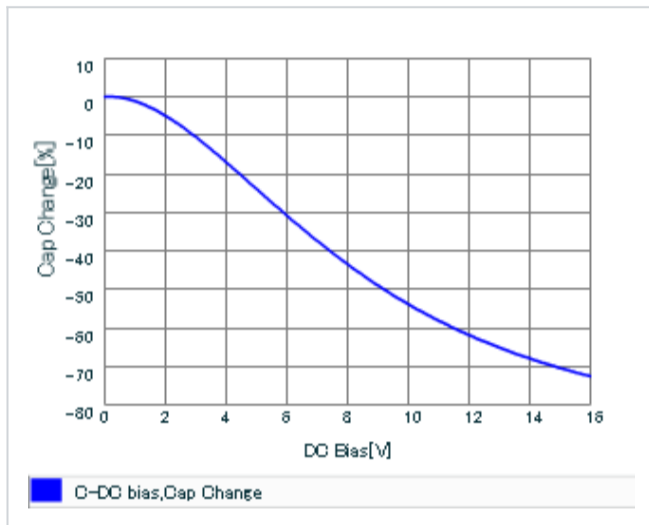

▪ AC voltage characteristics

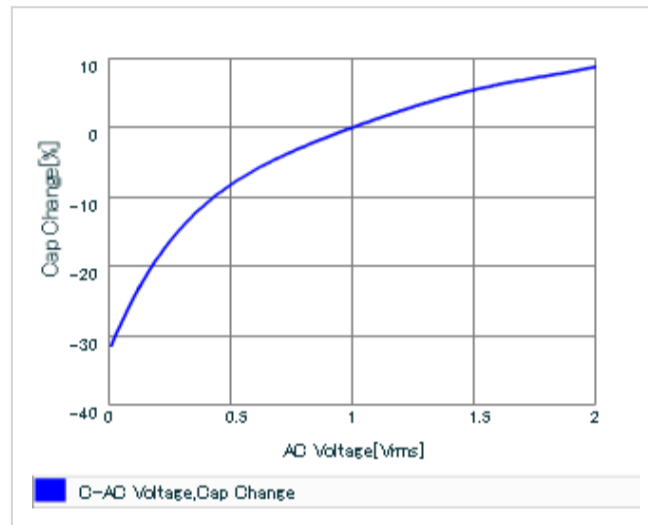

▪ Capacitance - temperature characteristics

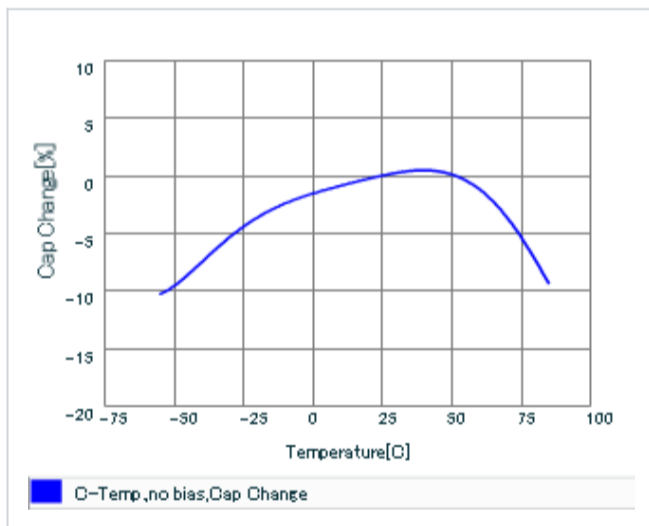

▪ Calorific property by ripple current

