

For FPC/FFC*

**FPC connectors
(0.5mm pitch)
Back lock**

Y5B/Y5BW
Series

FEATURES

1. Low profile, space saving back lock type with improved lever operability
2. Mechanical design freedom achieved by top and bottom double contacts

3. Wide selection, including a type with a small number of pins

Low profile and space saving design of 1.0 mm high and 3.20 mm deep (3.70 mm with lever)

Y5B and Y5BW can have a minimum of four and two contacts respectively, maximum reduction in design packaging.

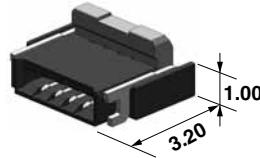

Unit: mm

4 pin contacts (Y5B: minimum)

4. Wiring patterns can be placed underneath the connector.
5. Man-hours for assembly can be reduced by delivering the connectors with their levers opened.
6. Y5BW features advanced functionality, including a structure to temporarily hold the FPC and a higher holding force.

The FPC holding contacts located on both ends of the connector facilitate positioning of FPC and further enhance the FPC holding force.

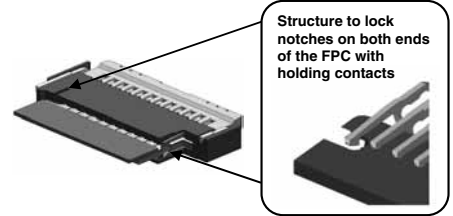

Applicable FPC shape



With notches

- (1) The inserted FPC can be temporarily held until the lever is closed.
- (2) When the lever is closed, the holding contacts lock the FPC by its notches, enhancing the FPC holding force.

* (Y5BW is compatible with FPC only.)

APPLICATIONS

A wide range of digital equipment, including mobile phones, smartphones, PCs, digital still camera, and digital video camera. Ideal for touch panels and LCD backlights, which require connectors with a small number of pins.

ORDERING INFORMATION

AYF 5 3 [] [] [] 5

53: FPC Connector 0.5 mm pitch (Back lock)

Number of pins (2 digits)

Function

3: Top and bottom double contacts (Y5B)

6: Top and bottom double contacts, lock holding type (Y5BW)

Surface treatment (Contact portion / Terminal portion)

5: Au plating/Au plating (Ni barrier)

PRODUCT TYPES

| Height | Y5B | | Y5BW | | Packing | |
|--------|----------------|-------------|----------------|-------------|-----------------------|---------------|
| | Number of pins | Part number | Number of pins | Part number | Inner carton (1-reel) | Outer carton |
| 1.0 mm | 4 | AYF530435 | 2 | AYF530265 | 5,000 pieces | 10,000 pieces |
| | 5 | AYF530535 | 3 | AYF530365 | | |
| | 6 | AYF530635 | 4 | AYF530465 | | |
| | 8 | AYF530835 | 6 | AYF530665 | | |
| | 10 | AYF531035 | 8 | AYF530865 | | |
| | 12 | AYF531235 | 10 | AYF531065 | | |
| | 14 | AYF531435 | 12 | AYF531265 | | |
| | 16 | AYF531635 | 14 | AYF531465 | | |
| | 24 | AYF532435 | 22 | AYF532265 | | |
| | 28 | AYF532835 | 26 | AYF532665 | | |
| | 30 | AYF533035 | 28 | AYF532865 | | |
| | 32 | AYF533235 | 30 | AYF533065 | | |
| | 34 | AYF533435 | 32 | AYF533265 | | |
| | 40 | AYF534035 | 38 | AYF533865 | | |
| | 42 | AYF534235 | 40 | AYF534065 | | |
| 50 | AYF535035 | 48 | AYF534865 | | | |

Notes: 1. Order unit;

For volume production: 1-inner carton (1-reel) units

Samples for mounting check: 50-connector units. Please contact our sales office.

Samples: Small lot orders are possible. Please contact our sales office.

2. Please contact our sales office for connectors having a number of pins other than those listed above.

SPECIFICATIONS

1. Characteristics

| Item | | Specifications | Conditions | | | | | | | | | | | | | | | | | | |
|--|---|--|---|-------|------------------|----------------|---|--------------------|----|---|---|--------|---|-------------------|----|---|---|--------|--|--------------------|--|
| Electrical characteristics | Rated current | 0.5A/pin contact (Except for holding contact) | | | | | | | | | | | | | | | | | | | |
| | Rated voltage | 50V AC/DC | | | | | | | | | | | | | | | | | | | |
| | Insulation resistance | Min. 1,000M Ω (initial) | Using 250V DC megger (applied for 1 min.) | | | | | | | | | | | | | | | | | | |
| | Breakdown voltage | 250V AC for 1 min. | No short-circuiting or damage at a detection current of 1 mA when the specified voltage is applied for one minute. | | | | | | | | | | | | | | | | | | |
| | Contact resistance | Max. 100m Ω | Based on the contact resistance measurement method specified by JIS C 5402. | | | | | | | | | | | | | | | | | | |
| Mechanical characteristics | FPC holding force | Y5B: Min. 0.2N/pin contacts \times pin contacts (initial) Y5BW: Min. 0.2N/pin contacts \times pin contacts + 2.0N (initial) | Measurement of the maximum force applied until the inserted compatible FPC is pulled out in the insertion axis direction while the connector lever is closed | | | | | | | | | | | | | | | | | | |
| Environmental characteristics | Ambient temperature | -55°C to +85°C | No freezing at low temperatures. No dew condensation. | | | | | | | | | | | | | | | | | | |
| | Storage temperature | -55°C to +85°C (product only) -40°C to +50°C (emboss packing) | | | | | | | | | | | | | | | | | | | |
| | Thermal shock resistance (with FPC mated) | 5 cycles, insulation resistance min. 100M Ω , contact resistance max. 100m Ω | Conformed to MIL-STD-202F, method 107G <table border="1"> <thead> <tr> <th>Order</th> <th>Temperature (°C)</th> <th>Time (minutes)</th> </tr> </thead> <tbody> <tr> <td>1</td> <td>-55$\frac{0}{-3}$</td> <td>30</td> </tr> <tr> <td>2</td> <td>{</td> <td>Max. 5</td> </tr> <tr> <td>3</td> <td>85$\frac{+3}{0}$</td> <td>30</td> </tr> <tr> <td>4</td> <td>{</td> <td>Max. 5</td> </tr> <tr> <td></td> <td>-55$\frac{0}{-3}$</td> <td></td> </tr> </tbody> </table> | Order | Temperature (°C) | Time (minutes) | 1 | -55 $\frac{0}{-3}$ | 30 | 2 | { | Max. 5 | 3 | 85 $\frac{+3}{0}$ | 30 | 4 | { | Max. 5 | | -55 $\frac{0}{-3}$ | |
| | Order | Temperature (°C) | Time (minutes) | | | | | | | | | | | | | | | | | | |
| | 1 | -55 $\frac{0}{-3}$ | 30 | | | | | | | | | | | | | | | | | | |
| | 2 | { | Max. 5 | | | | | | | | | | | | | | | | | | |
| | 3 | 85 $\frac{+3}{0}$ | 30 | | | | | | | | | | | | | | | | | | |
| 4 | { | Max. 5 | | | | | | | | | | | | | | | | | | | |
| | -55 $\frac{0}{-3}$ | | | | | | | | | | | | | | | | | | | | |
| Humidity resistance (with FPC mated) | 120 hours, insulation resistance min. 100M Ω , contact resistance max. 100m Ω | Bath temperature 40 \pm 2°C, humidity 90 to 95% R.H. | | | | | | | | | | | | | | | | | | | |
| Saltwater spray resistance (with FPC mated) | 24 hours, insulation resistance min. 100M Ω , contact resistance max. 100m Ω | Bath temperature 35 \pm 2°C, saltwater concentration 5 \pm 1% | | | | | | | | | | | | | | | | | | | |
| H ₂ S resistance (with FPC mated) | 48 hours, contact resistance max. 100m Ω | Bath temperature 40 \pm 2°C, gas concentration 3 \pm 1 ppm, humidity 75 to 80% R.H. | | | | | | | | | | | | | | | | | | | |
| Soldering heat resistance | Peak temperature: 260°C or less 300°C within 5 sec. 350°C within 3 sec. | Reflow soldering Soldering iron | | | | | | | | | | | | | | | | | | | |
| Lifetime characteristics | Insertion and removal life | 20 times | Repeated insertion and removal: min. 10 sec./time | | | | | | | | | | | | | | | | | | |
| Unit weight | Y5B (50 pin contacts): 0.16 g | | | | | | | | | | | | | | | | | | | | |

2. Material and surface treatment

| Part name | Material | Surface treatment |
|-----------------------------|--|---|
| Molded portion | Housing: LCP resin (UL94V-0) Lever: LCP resin (UL94V-0) | — |
| Contact | Copper alloy | Contact portion; Base: Ni plating, Surface: Au plating Terminal portion; Base: Ni plating, Surface: Au plating |
| Holding contact portion | Copper alloy | Terminal portion; Base: Ni plating, Surface: Au plating |
| Soldering terminals portion | Copper alloy | Base: Ni plating, Surface: Au plating |

AYF53

DIMENSIONS (Unit: mm)

The CAD data of the products with a **CAD Data** mark can be downloaded from: <http://industrial.panasonic.com/ac/e/>

Y5B

CAD Data

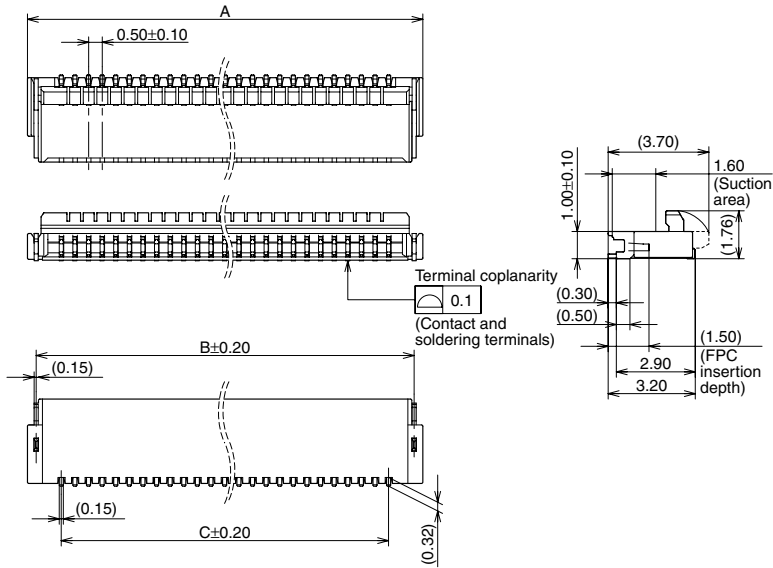

General tolerance: ± 0.3

| Number of pins/ dimension | A | B | C |
|------------------------------|-------|-------|-------|
| 4 | 4.00 | 3.36 | 1.50 |
| 5 | 4.50 | 3.86 | 2.00 |
| 6 | 5.00 | 4.36 | 2.50 |
| 8 | 6.00 | 5.36 | 3.50 |
| 10 | 7.00 | 6.36 | 4.50 |
| 12 | 8.00 | 7.36 | 5.50 |
| 14 | 9.00 | 8.36 | 6.50 |
| 16 | 10.00 | 9.36 | 7.50 |
| 24 | 14.00 | 13.36 | 11.50 |
| 28 | 16.00 | 15.36 | 13.50 |
| 30 | 17.00 | 16.36 | 14.50 |
| 32 | 18.00 | 17.36 | 15.50 |
| 34 | 19.00 | 18.36 | 16.50 |
| 40 | 22.00 | 21.36 | 19.50 |
| 42 | 23.00 | 22.36 | 20.50 |
| 50 | 27.00 | 26.36 | 24.50 |

Y5B RECOMMENDED FPC/FFC DIMENSIONS

(Finished thickness: $t = 0.3 \pm 0.03$)

The conductive parts should be based by Ni plating and then Au plating.

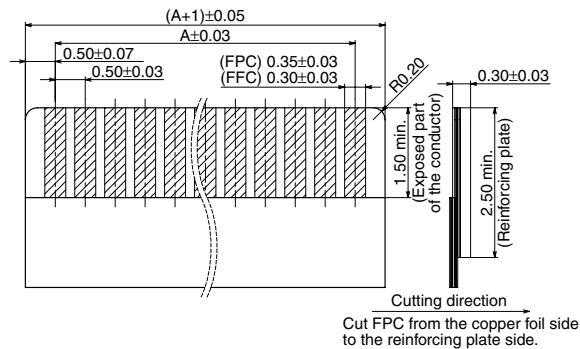

| Number of pins/ dimension | A |
|------------------------------|-------|
| 4 | 1.50 |
| 5 | 2.00 |
| 6 | 2.50 |
| 8 | 3.50 |
| 10 | 4.50 |
| 12 | 5.50 |
| 14 | 6.50 |
| 16 | 7.50 |
| 24 | 11.50 |
| 28 | 13.50 |
| 30 | 14.50 |
| 32 | 15.50 |
| 34 | 16.50 |
| 40 | 19.50 |
| 42 | 20.50 |
| 50 | 24.50 |

Y5BW

CAD Data

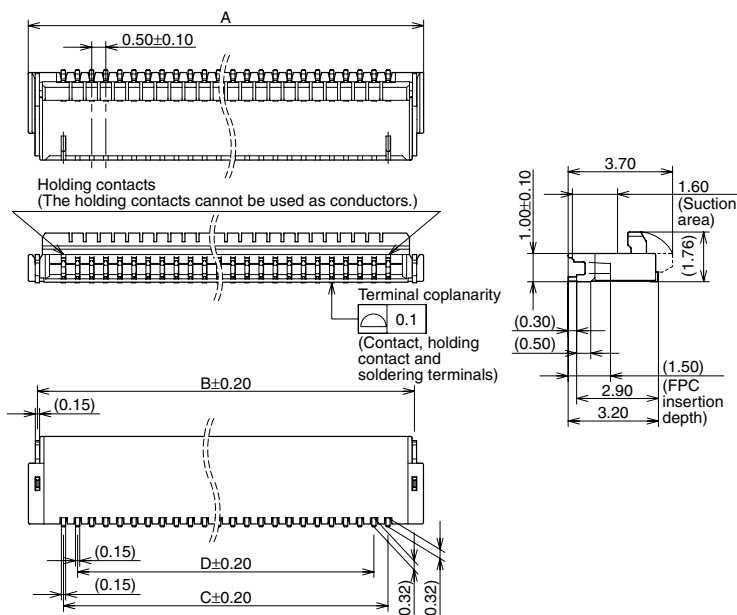
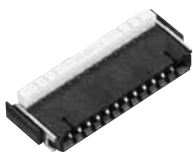

General tolerance: ± 0.3

| Number of pins/ dimension | A | B | C | D |
|------------------------------|-------|-------|-------|-------|
| 2 | 4.00 | 3.36 | 1.50 | 0.50 |
| 3 | 4.50 | 3.86 | 2.00 | 1.00 |
| 4 | 5.00 | 4.36 | 2.50 | 1.50 |
| 6 | 6.00 | 5.36 | 3.50 | 2.50 |
| 8 | 7.00 | 6.36 | 4.50 | 3.50 |
| 10 | 8.00 | 7.36 | 5.50 | 4.50 |
| 12 | 9.00 | 8.36 | 6.50 | 5.50 |
| 14 | 10.00 | 9.36 | 7.50 | 6.50 |
| 22 | 14.00 | 13.36 | 11.50 | 10.50 |
| 26 | 16.00 | 15.36 | 13.50 | 12.50 |
| 28 | 17.00 | 16.36 | 14.50 | 13.50 |
| 30 | 18.00 | 17.36 | 15.50 | 14.50 |
| 32 | 19.00 | 18.36 | 16.50 | 15.50 |
| 38 | 22.00 | 21.36 | 19.50 | 18.50 |
| 40 | 23.00 | 22.36 | 20.50 | 19.50 |
| 48 | 27.00 | 26.36 | 24.50 | 23.50 |

Y5BW RECOMMENDED FPC DIMENSIONS

(Finished thickness: $t = 0.3 \pm 0.03$)

The conductive parts should be based by Ni plating and then Au plating.

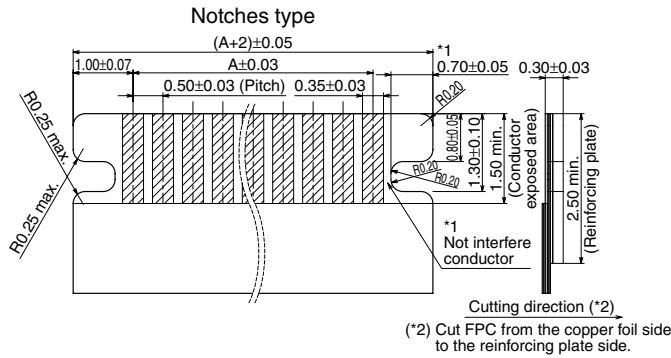

| Number of pins/ dimension | A |
|------------------------------|-------|
| 2 | 0.50 |
| 3 | 1.00 |
| 4 | 1.50 |
| 6 | 2.50 |
| 8 | 3.50 |
| 10 | 4.50 |
| 12 | 5.50 |
| 14 | 6.50 |
| 22 | 10.50 |
| 26 | 12.50 |
| 28 | 13.50 |
| 30 | 14.50 |
| 32 | 15.50 |
| 38 | 18.50 |
| 40 | 19.50 |
| 48 | 23.50 |

EMBOSSED TAPE DIMENSIONS (Unit: mm) (Common for respective contact type)

• Specifications for taping

• Specifications for the plastic reel
(In accordance with EIAJ ET-7200B.)

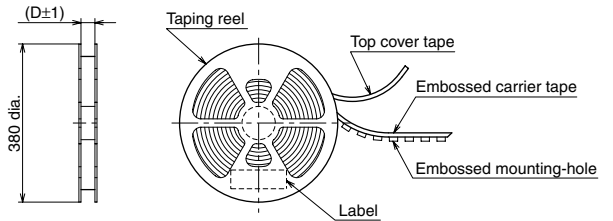
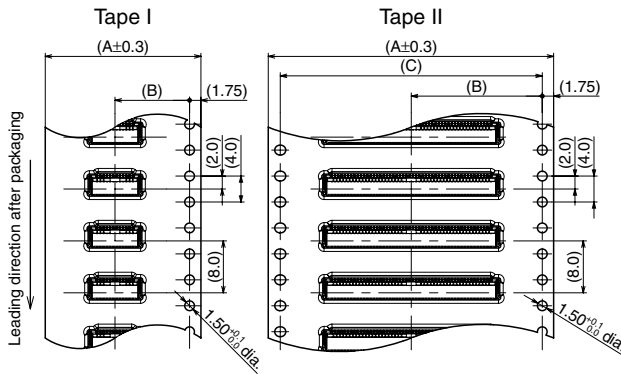

• Y5B Dimension table (Unit: mm)

| Number of pins | Type of taping | A | B | C | D | Quantity per reel |
|----------------|----------------|-------|-------|-------|-------|-------------------|
| 4 to 10 | Tape I | 16.00 | 7.50 | — | 17.40 | 5,000 |
| 12 to 30 | Tape I | 24.00 | 11.50 | — | 25.40 | 5,000 |
| 32 to 34 | Tape II | 32.00 | 14.20 | 28.40 | 33.40 | 5,000 |
| 40 to 50 | Tape II | 44.00 | 20.20 | 40.40 | 45.40 | 5,000 |

• Y5BW Dimension table (Unit: mm)

| Number of pins | Type of taping | A | B | C | D | Quantity per reel |
|----------------|----------------|-------|-------|-------|-------|-------------------|
| 2 to 8 | Tape I | 16.00 | 7.50 | — | 17.40 | 5,000 |
| 10 to 28 | Tape I | 24.00 | 11.50 | — | 25.40 | 5,000 |
| 30 to 32 | Tape II | 32.00 | 14.20 | 28.40 | 33.40 | 5,000 |
| 38 to 48 | Tape II | 44.00 | 20.20 | 40.40 | 45.40 | 5,000 |

• Connector orientation with respect to embossed tape feeding direction

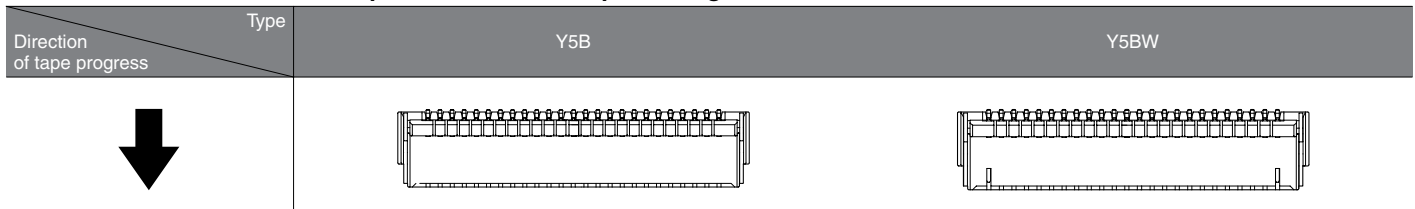

NOTES

1. Recommended PC board and metal mask patterns

Connectors are mounted with high pitch density, intervals of 0.3 mm or 0.5 mm. In order to reduce solder and flux rise, solder bridges and other issues make sure the proper levels of solder is used. The figures to the right are recommended metal mask patterns. Please use them as a reference.

Please refer to the latest product specifications when designing your product.

•Y5B/Y5BW

Recommended PC board pattern
(mounting layout)
(TOP VIEW)

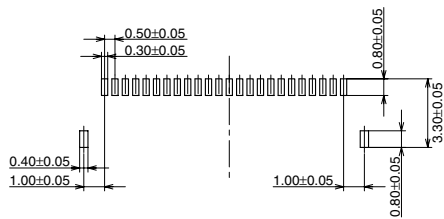

Recommended metal mask pattern

Metal mask thickness: When $120\mu\text{m}$
(Terminal portion opening area ratio: 31.8%)
(Soldering terminal portion opening area ratio: 100%)

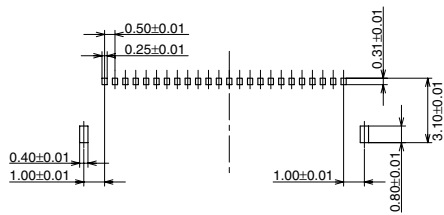

Notes on Using FPC Connectors

■ PC board design

Design the recommended foot pattern in order to secure the mechanical strength in the soldered areas of the terminal.

■ FPC and equipment design

- Design the FPC based with recommended dimensions to ensure the required connector performance.
- When using back lock type, secure enough space for closing the lever and for open-close operation of the lever.
- Make sure that connector positioning and FPC length are appropriate to prevent diagonal insertion of the FPC. Due to the FPC size, weight, or the reaction force of the routed FPC, FPC may be removed. Carefully check the equipment design. Take required measures to prevent the FPC from being removed due to a fall, vibration, or other impact.

(Y3BW/Y5BW)

■ The holding contacts cannot be used as conductors.

The holding contacts are located on both ends of the contacts, and the shape of the soldered portions is the same as that of the other contacts.

Use caution to ensure connect identification.

(Y3BL)

■ Soldering terminal structure

Since soldering terminals touch FPC, note that the short circuit may occur when the metal parts exposed on side of FPC.

■ Connector mounting

Excessive moulder chucking force may deform the molded or metal part of the connector. Consult us in advance if chucking is to be applied.

■ Soldering

1) Manual soldering

- Due to the connector's compact size, if an excessive amount of solder is applied during manual soldering, the solder may creep up and flux wicking near the contact points, or solder interference may cause contact failure.
- Make sure that the soldering iron tip is heated within the temperature and time limits indicated in the specifications.
- Flux from the solder wire may adhere to the contact surfaces during soldering operations. After soldering, carefully check the contact surfaces and cleans off any flux solder use.
- Be aware that a load applied to the connector terminals while soldering may displace the contact.
- Thoroughly clean the iron tip.

2) Reflow soldering

- Screen-printing is recommended for printing paste solder.
- To achieve the appropriate soldering state, make sure that the reflow temperature, PC board foot pattern, window size and thickness of metal mask are recommended condition.
- Note that excess solder on the terminals prevents complete insertion of the FPC, and causes flux climbing up.
- A screen thickness of 120 μ m is recommended during cream solder printing.
- Consult us when using a screen-printing thickness other than that recommended.
- Depending on the size of the connector being used, self alignment may not be possible. Accordingly, carefully position the terminal with the PC board pattern.

- The recommended reflow temperature profile is given in the figure below.

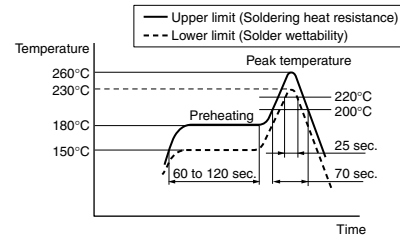

- The temperature is measured on the surface of the PC board near the connector terminals.
- Depending on reflow condition, poor contact may occur by solder and flux wicking.

Please set the reflow conditions that considering the characteristics of solder and flux. Also please make consideration in setting the reflow times and O₂ concentration to prevent poor contact by solder and flux wicking.

- When performing reflow soldering on the back of the PC board after reflow soldering the connector, secure the connector using, for example, an adhesive.

(Double reflow soldering on the same side is possible.)

Do not touch the lever or apply any load to the lever until the second reflow soldering. Otherwise, contact deflection occurs and the terminals may be deformed by reflow heating.

3) Reworking on a soldered portion

- Finish reworking in one operation.
- For reworking of the solder bridge, use a soldering iron with a flat tip. Do not add flux, otherwise the flux may creep to the contact parts.

When adding the solder for reworking, do not add an excessive solder. Otherwise, solder and flux may creep up and solder bridges may occur.

- Use a soldering iron whose tip temperature is within the temperature range specified in the specifications.

■ Do not drop or handle the connector carelessly.

Otherwise, the terminals may become deformed due to excessive force or applied solderability may be during reflow degrade.

■ Do not open/close the lever or insert/remove an FPC until the connector is soldered. Forcibly applied external pressure on the terminals can weaken the adherence of the terminals to the molded part or cause the terminals to lose their evenness. In addition, do not insert an FPC into the connector before soldering the connector.

■ When cutting or bending the PC board after mounting the connector, be careful that the soldered sections are subjected to excessive force.

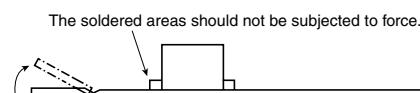

Notes on Using FPC Connectors

■ Precautions for insertion/removal of FPC

<Front-Lock>

- To open the lever, hold its center and pull it up. An uneven load applied to the lever on one side may deform and break the lever. Do not apply an excessive load to the lever in the opening direction, otherwise, the terminals may be deformed.
- Don't further apply an excessive load to the fully opened lever; otherwise, the lever may be deformed.
- Fully open the lever to insert an FPC.
- Since this product connects at the bottom, please insert the FPC so that its electrode plane is facing the board to which it will be mounted. Do not insert the FPC in the reverse direction of the contact section; otherwise, operation failures or malfunctions may be caused.

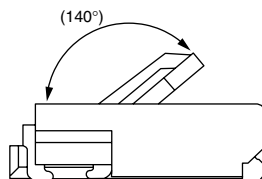

(Y3FT)

- This product has a structure to position an inserted FPC using the FPC tabs. Therefore, insert an FPC at an angle to the board. If the FPC is inserted in the direction parallel to the board, the molded positioning parts block the FPC, leading to incomplete insertion. Do not insert the FPC at an excessive angle to the board. Otherwise, it may cause the deformation of metal parts, FPC insertion failures, and FPC circuit breakages.

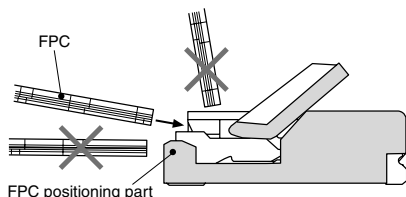

(Y3F)

- Completely insert the FPC horizontally. Do not insert the FPC at an excessive angle to the board. Otherwise, it may cause the deformation of metal parts, FPC insertion failures, and FPC circuit breakages.

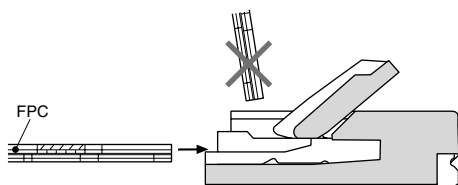

- Insert the FPC to the full depth of the connector without altering the angle.
- When closing the lever, carefully use the tip of your finger to push the entire lever or both sides of it. If pressure to the lever is applied unevenly, IE: only the edge, it may deform or break the FPC. Make sure that the lever is closed completely. Not doing so will cause a faulty connection.
- Avoid applying an excessive load to the top of the lever during or after closing the lever. Otherwise, the terminals may be deformed.
- Remove the FPC at an angle with the lever fully opened. If the lever is closed, or if the FPC is forcedly pulled into a direction parallel to the board, the molded part may break.

<Back-Lock>

- Avoid touching the lever (applying any external force) until an FPC is inserted.
- Do not open/close the lever without an FPC inserted. Failure to follow this instruction will cause the contacts to warp, leading to the contact tips to interfere with the insertion of an FPC, deforming the terminals. Failure to follow this instruction may cause the lever to be removed, terminals to be deformed, and/or the FPC insertion force to increase.

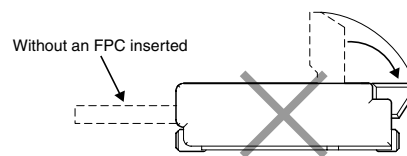

- The FPC insertion section is on the opposite side of the lever. Be careful not to make a mistake in the FPC insertion position or the lever opening/closing position. Otherwise, a contact failure or connector breakage may occur.
- Do not insert an FPC upside down. Inserting an FPC in a direction opposite to that you intended may cause an operation failure or malfunction.
- Insert an FPC with the lever opened at right angle, that is, in the factory default position.
- Completely insert the FPC horizontally. An FPC inserted at an excessive angle to the board may cause the deformation of metal parts, FPC insertion failures, and FPC circuit breakages.
- Insert the FPC to the full depth of the connector without altering the angle.
- Insert the FPC into the connector after checking the position of FPC insertion slot and FPC. Do not insert the FPC without positioning the FPC and connector. Otherwise, it may cause connector breakages. When it is hard to insert the FPC, do not insert the FPC on that condition. Confirm the FPC and connector positioning.
- Do not apply an excessive load to the lever in the opening direction beyond its open position; otherwise, the lever may be deformed or removed.
- Do not apply an excessive load to the lever in a direction perpendicular to the lever rotation axis or in the lever opening direction; otherwise, the terminals may be deformed, and the lever may be removed.

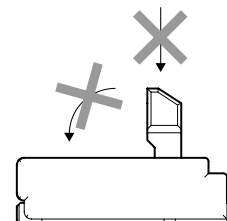

- To close the lever, turn down the lever by pressing the entire lever or both sides of the lever with fingers tips. And close the lever completely. Be careful not to apply partial load to the lever that may cause its deformation or destruction. Close the lever completely to prevent contact failure.
- If pressure to the lever is applied unevenly, it may deform or break the FPC. Make sure that the lever is closed completely. Not doing so will cause a faulty connection.
- Avoid applying an excessive load to the top of the lever during or after closing the lever. Otherwise, the terminals may be deformed.
- When opening the lever to remove the FPC, ensure that the lever will not go over the initial position; otherwise, the lever may be removed.

Notes on Using FPC Connectors

- Remove the FPC at parallel with the lever fully opened. If the lever is closed, or if the FPC is forcedly pulled, the product or FPC may break.
- If a lever is accidentally detached during the handling of a connector, do not use the connector any longer.

■ **After an FPC is inserted, carefully handle it so as not to apply excessive stress to the base of the FPC. When using FPC with a bent condition, please pay attention to precautions below; otherwise, in some conditions it may cause conduction failure, connector breakage, unlocking lever or FPC disconnection.**

- Design so that a load is not applied to connector directly by FPC bending.
- Avoid sharp FPC bending at the root of FPC insertion part.
- Design so that a load is not applied to the part of FPC bending.
- Fix the FPC if there might be a load on FPC when using the FPC with cutout, do not apply a bending load to the cutout part of FPC. Otherwise, it may cause FPC disconnection and deformation since the cutout part of FPC is subjected to bending stress.

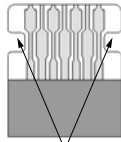

FPC cutout part

■ Other cautions

- When coating the PC board after soldering the connector (to prevent the deterioration of insulation), perform the coating in such a way so that the coating does not get on the connector.
- The connectors are not meant to be used for switching.
- There is no problem on the product quality though the swelling and the black spot, etc. might be generated in the molding parts.

Please refer to the latest product specifications when designing your product.