

## Current Sensing Resistors, Metal Plate Type



Type: **ERJ MS4, MS6, MB1**

### Features

- Ideal for current sensing solution
- Small case size with high power
- Metal plate bonding technology. Excellent long term stability
- Outer Resin with high heat dissipation. Wide temperature range (-65 °C to +170 °C)
- AEC-Q200 qualified
- RoHS compliant
- ISO9001, ISO/TS16949 certified

### As for Packaging Methods, Soldering Conditions and Safety Precautions,

Please see Data Files

### Explanation of Part Numbers

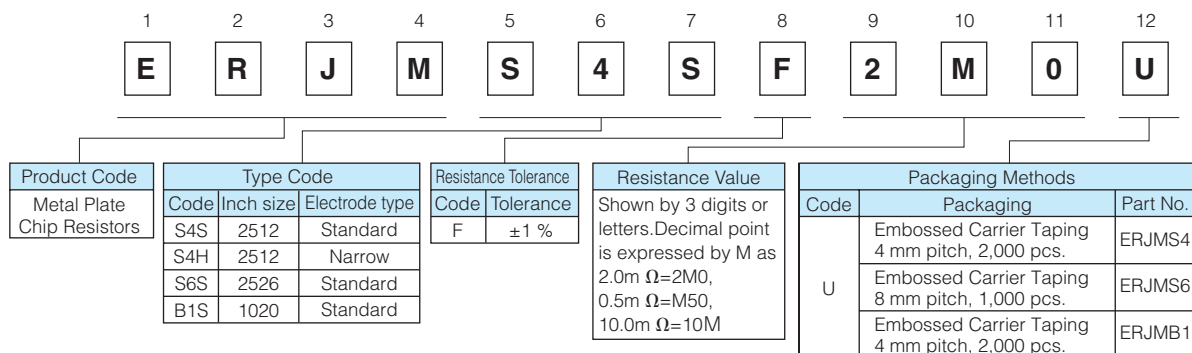

### Ratings

Part No. (inch size)	Power Rating at 70 °C (W)	Resistance Range (mΩ)	Resistance Tolerance (%)	T.C.R. (× 10 <sup>-6</sup> /°C)	Category Temperature Range (°C)	Terminal temp. upper limit (°C)
ERJMS4S (2512)	3	1, 2, 3, 4	F : ±1	±75	-65 to +170	130
ERJMS4H (2512)	3	5, 6	F : ±1	±75	-65 to +170	130
	2	7, 8, 9, 10	F : ±1	±75	-65 to +170	100
ERJMS6S (2526)	5	0.5, 1, 2	F : ±1	±75	-65 to +170	130
ERJMB1S (1020)	2	1, 2, 3, 4, 5	F : ±1	±75	-65 to +170	130

\* Please contact us when resistors of irregular series are needed.

### Power Derating Curve

If the terminal temperature of the resistor is more than terminal temperature upper limit value of the rated table, please reduce the rated power according to the Power Derating Curve shown in the figure on the right.

<Supplemented>

In the case of the temperature measurement of the terminal portion of the resistor, Please perform under the following conditions.

- 1) Terminal temperature measurement, please apply the temperature of the higher of either the left or right electrode upper surface of the resistor.
- 2) Please measure the temperature of the resistor in the land pattern printed of circuit board and plan to use by real conditions.

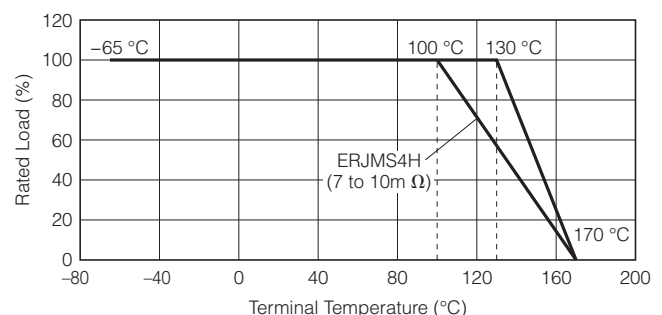

# Panasonic Current Sensing Resistors, Metal Plate Type

## Construction

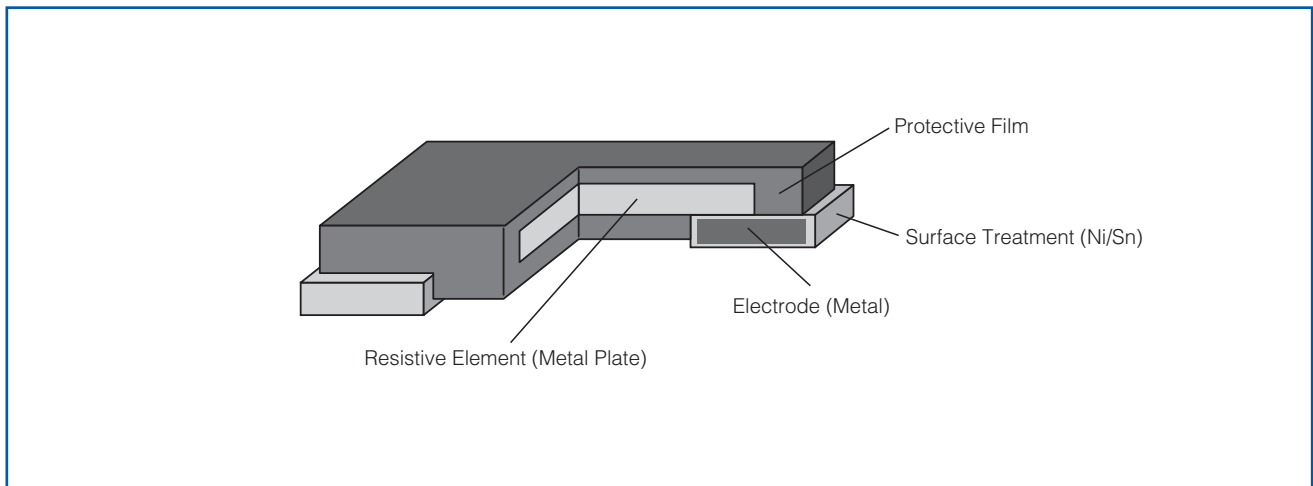

## Dimensions in mm (not to scale), Recommended Land Pattern

### ● ERJMS4S/ERJMS4H

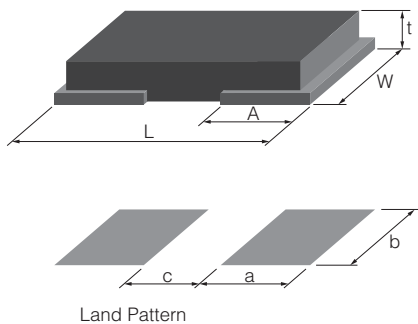

### ● ERJMS6S

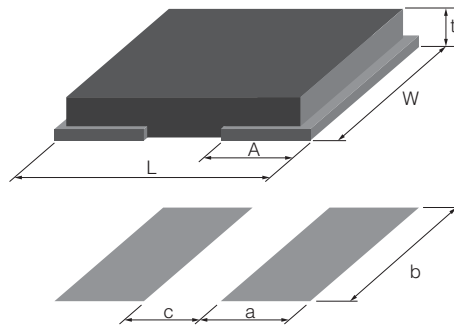

### ● ERJMB1S

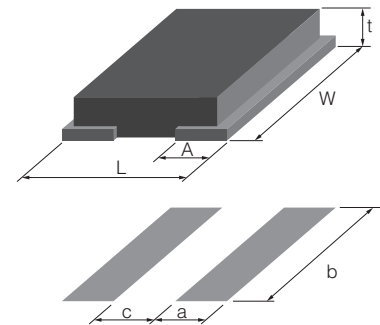

Part No. (inch size)	Dimension (mm)				Recommended Land Pattern (mm)			Mass (Weight) (g/1000 pcs.)
	L	W	A	t	a	b	c	
ERJMS4S (2512)	6.40±0.25	3.20±0.25	2.20±0.25	1.20±0.15	2.7	3.4	2.0	120
ERJMS4H (2512)	6.40±0.25	3.20±0.25	1.25±0.25	1.20±0.15	1.7	3.4	4.0	115
ERJMS6S (2526)	6.40±0.25	6.80±0.25	2.20±0.25	1.20±0.15	2.7	7.0	2.0	260
ERJMS6S (1020)	2.55±0.25	5.00±0.25	0.68 <sup>+0.15</sup> <sub>-0.20</sub>	0.90±0.15	1.15	5.5	1.1	40

## Typical Temperature dependence of electrical resistance

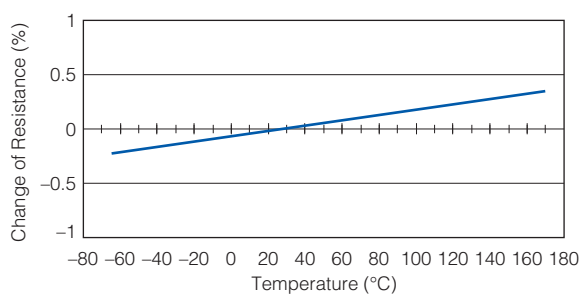

## Long-term stability

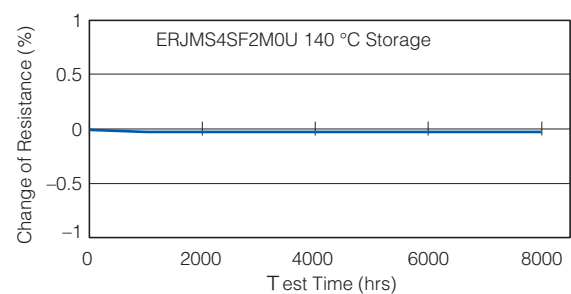

## Maximum pulse energy respectively pulse power for continuous operation

Reference Data  
 Condition : Room Temperature, OFF : 10 s, 1000 cycle, Wave form : Square  
 Change of Resistance =  $\pm 1\%$

### ● ERJMS4 type

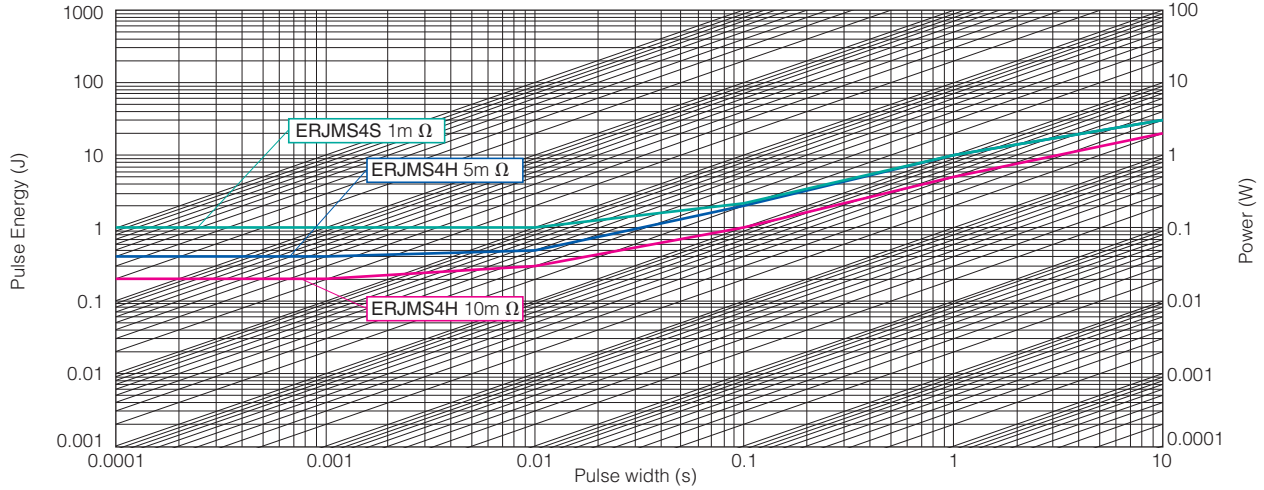

### ● ERJMS6 type

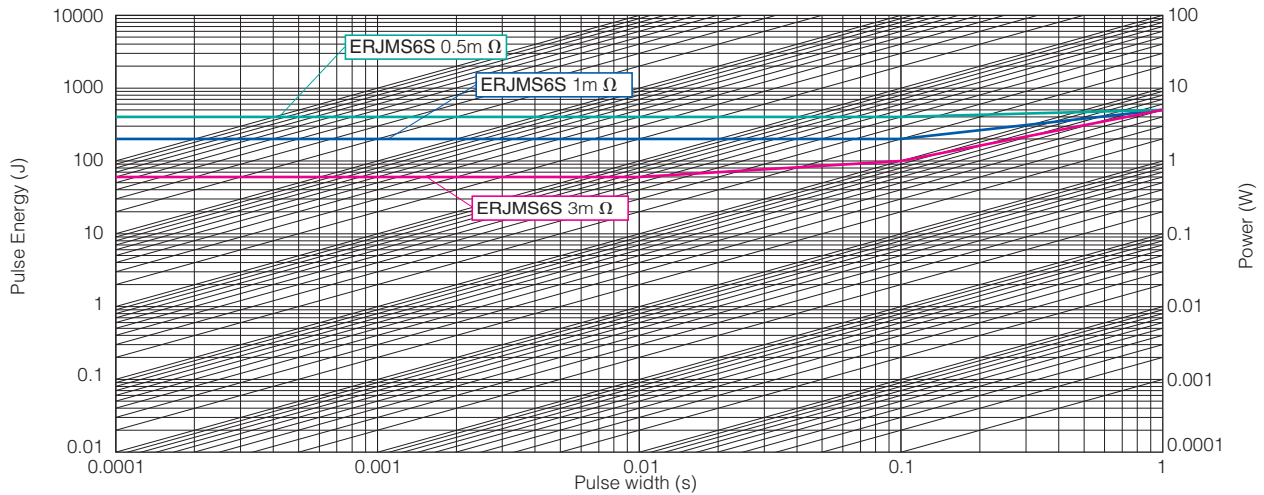

### ● ERJMB1 type

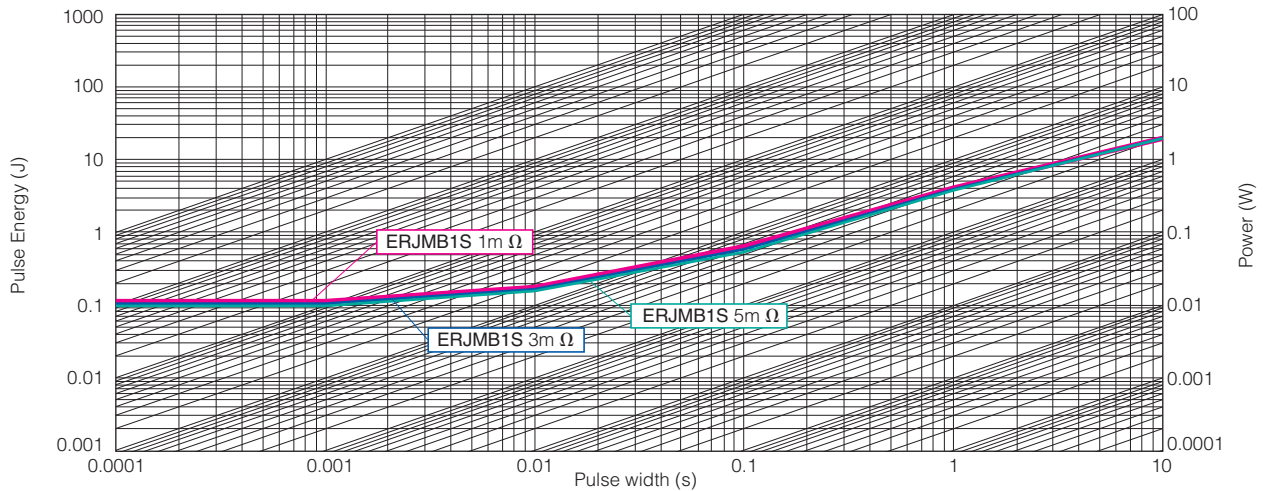

## Performance (AEC-Q200)

### ● ERJMS4, ERJMS6 type

Test Item	Test Condition	Specification	Typical value
Thermal Shock	-55 °C/155 °C, 1000cycles	±1 %	0.20 %
Overload	3 × Rated Power, 5 sec	±0.5 %	0.10 %
Solderability	245 °C, 3 sec	> 95% coverage	> 95% coverage
Resistance to Solvents	MIL-STD-202 method 215, 2.1a, 2.1d	No damage	No damage
Low Temperature Storage and Operation	-65 °C, 24 h	±0.5 %	0.03 %
Resistance to Soldering Heat	MIL-STD-202 method 210 (260 °C, 10s)	±0.5 %	0.10 %
Moisture Resistance	MIL-STD-202 method 106	±0.5 %	0.10 %
Shock	MIL-STD-202 method 213-A	±0.5 %	0.10 %
Vibration, High Frequency	10 to 2000 (Hz)	±0.5 %	0.05 %
Life	70 °C, Rated Power, 2000 h	±1 %	0.30 %
Storage Life at Elevated Temperature	170 °C, 2000 h	±1 %	0.30 %
High Temperature Characteristics	140 °C, 2000 h	±0.5 %	0.05 %
Frequency Characteristics	Inductance	< 5 nH	< 2 nH

### ● ERJMB1 type

Test Item	Test Condition	Specification	Typical value
Thermal Shock	-55 °C/155 °C, 1000cycles	±1 %	0.30 %
Overload	2.5 × Rated Power, 5 sec	±1 %	0.30 %
Solderability	245 °C, 3 sec	> 95% coverage	> 95% coverage
Resistance to Solvents	MIL-STD-202 method 215, 2.1a, 2.1d	No damage	No damage
Low Temperature Storage and Operation	-65 °C, 24 h	±0.5 %	0.03 %
Resistance to Soldering Heat	MIL-STD-202 method 210 (260 °C, 10s)	±0.5 %	0.10 %
Moisture Resistance	MIL-STD-202 method 106	±0.5 %	0.10 %
Shock	MIL-STD-202 method 213-A	±0.5 %	0.10 %
Vibration, High Frequency	10 to 2000 (Hz)	±0.5 %	0.05 %
Life	70 °C, Rated Power, 2000 h	±1 %	0.30 %
Storage Life at Elevated Temperature	170 °C, 2000 h	±1 %	0.30 %
High Temperature Characteristics	140 °C, 2000 h	±0.5 %	0.05 %
Frequency Characteristics	Inductance	< 5 nH	< 2 nH

## Temperature Rise

### ● ERJMS4HF5M0U

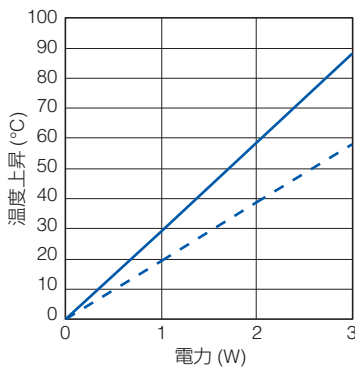

### ● ERJMS6SF2M0U

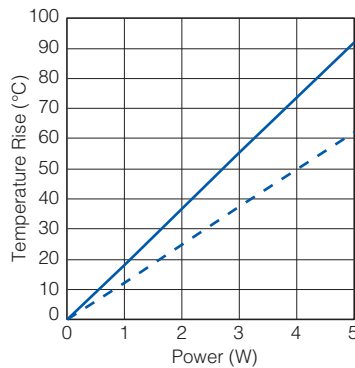

### ● ERJMB1SF3M0U

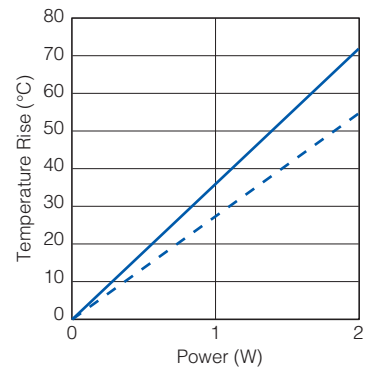

① ———— <Condition>  
 Base material : FR-4 (t1.6mm)  
 Copper Thickness : 70 μm, Two layer

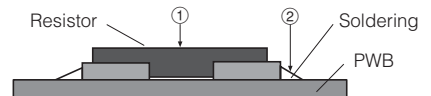

## Sense terminal-Layout

