

PulseJack™ 1xN Tab-Down

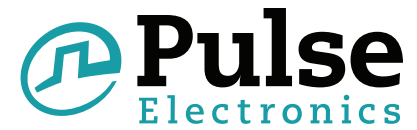

Description:

100 Base-TX (Fast Ethernet) RJ45 1xN Tab-DOWN with or without LEDs integrated magnetics connector (ICM) designed to support applications such as: SOHO (ADSL modems), LAN-on-Motherboard (LOM), Hub and Switches.



Features and Benefits:

- Ⓜ RoHS peak wave solder temperature rating 260°C
- Ⓜ Suitable for CAT 5 & 6 Fast Ethernet Cable or better UTP
- Ⓜ Meets IEEE 802.3 specification
- Ⓜ 350µH minimum OCL with 8mA bias current
- Ⓜ High performance for maximum EMI suppression

Electrical Specifications @ 25°C - Operating Temperature 0°C to +70°C

RoHS Compliant Part Number	Turns Ratio		Number of Ports	LEDs ¹ L/D	Insertion Loss TX/RX (dB TYP)	Return Loss (dB TYP) 100Ω (± 15 Ω)				Crosstalk (dB TYP)			Common Mode Rejection (dB TYP)		Hipot (Vrms MIN) @ 60 Hz 1 minute
	TX	RX				1-100 MHz	1-10 MHz	30 MHz	60-80 MHz	1-30 MHz	30-60 MHz	60-100 MHz	1-50 MHz	50-130 MHz	
J8064D628ANL	1CT:1CT	1CT:1CT	1x2	G/Y	-1.0	-20	-16	-12	-40	-35	-30	-30	-20	1500	
JX80-0019NL ²	1CT:1CT	1CT:1CT	1x2	G/G	-1.0	-20	-16	-12	-40	-35	-30	-30	-20	1500	
J8064D648ANL	1CT:1CT	1CT:1CT	1x4	G/Y	-1.0	-20	-16	-12	-40	-35	-30	-30	-20	1500	
JX80-0022NL ²	1CT:1CT	1CT:1CT	1x4	G/G	-1.0	-20	-16	-12	-40	-35	-30	-30	-20	1500	
J8064D668ANL	1CT:1CT	1CT:1CT	1x6	G/Y	-1.0	-20	-16	-12	-40	-35	-30	-30	-20	1500	
JX8064D668ANL ²	1CT:1CT	1CT:1CT	1x6	G/Y	-1.0	-20	-16	-12	-40	-35	-30	-30	-20	1500	
J8064D688ANL	1CT:1CT	1CT:1CT	1x8	G/Y	-1.0	-20	-16	-12	-40	-35	-30	-30	-20	1500	
JX8064D688ANL ²	1CT:1CT	1CT:1CT	1x8	G/Y	-1.0	-20	-16	-12	-40	-35	-30	-30	-20	1500	
J8064E62NL	1CT:1CT	1CT:1CT	1x2	None	-1.0	-20	-16	-12	-40	-35	-30	-30	-20	1500	
J8064E64NL	1CT:1CT	1CT:1CT	1x4	None	-1.0	-20	-16	-12	-40	-35	-30	-30w	-20	1500	
J8064E66NL	1CT:1CT	1CT:1CT	1x6	None	-1.0	-20	-16	-12	-40	-35	-30	-30	-20	1500	
J8064E68NL	1CT:1CT	1CT:1CT	1x8	None	-1.0	-20	-16	-12	-40	-35	-30	-30	-30	1500	

Notes: 1. LEDs Left/Right: G = green; Y = yellow 2. Operating temperature: -40°C to +85°C

RJ45 Durability Test Rating

Part Number	Mating Force (MAX)	Unmating Force (MAX)	Durability	Plug to Jack Retention (MIN)
J80 Series	5 lbs./2.268 kgs.	5 lbs./2.268 kgs.	750 Insertions	20 lbs./9.072 kgs.

USA 858 674 8100

Germany 49 7032 7806 0

Singapore 65 6287 8998

Shanghai 86 21 62787060

China 86 755 33966678

Taiwan 886 3 4356768

RJ45 Material Specification

Part Number	Shield		Contact			Housing		
	Material	Finish	Material	Plating Area	Solder Area	Material	Specification	MSL ²
J80 Series	Brass	10-20μ inches thick Nickel over 10-20μ inches thick nickel	Phosphor Bronze	Nickel underplating and selective gold plating 30μ inches	Tin matte finish	Thermoplastic	UL 94 V-0	1

Notes: 1. Connector dimensions comply with FCC dimension requirements 2. MSL = Moisture Sensitivity Level rating from 1 to 5 (highest rating = 1, lowest rating = 5).

Mechanicals

J8064D628ANL, JX80-0019NL

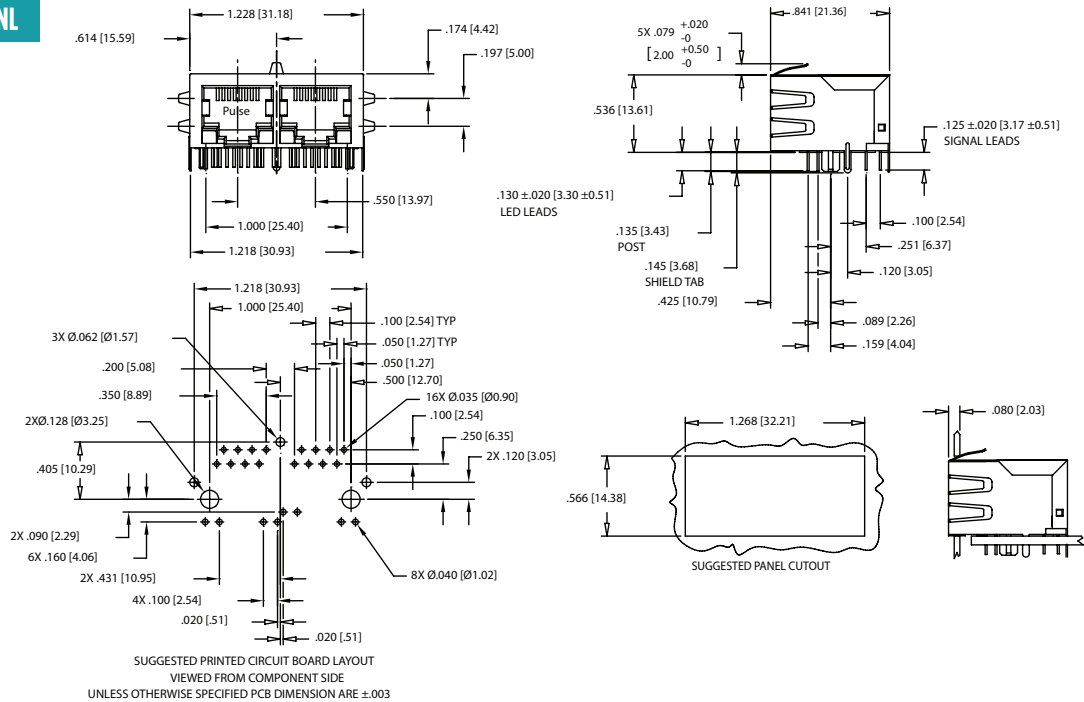

J8064E62NL

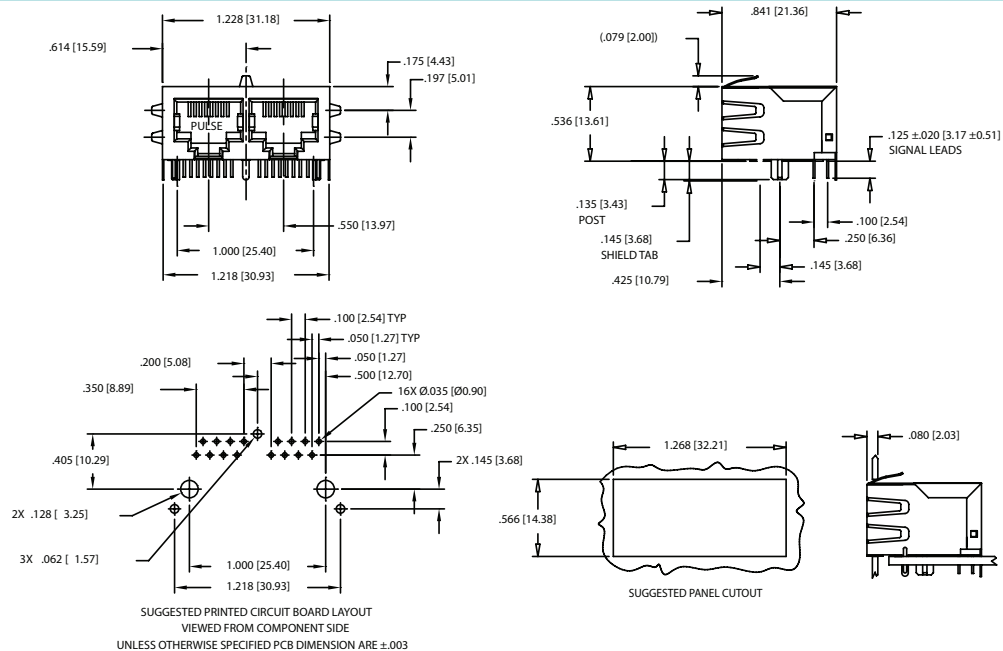

Mechanicals

J8064D648ANL
JX80-002ZNL

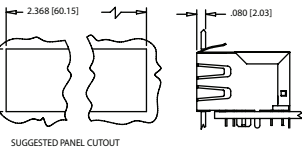
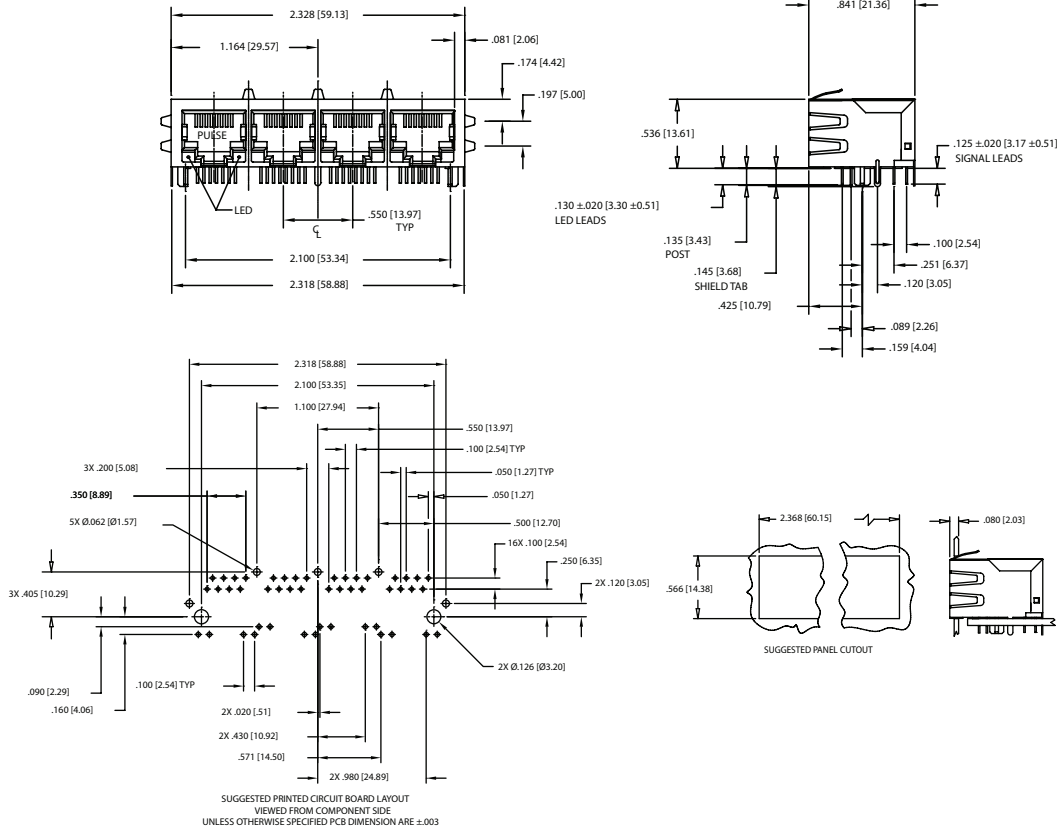

J8064E64NL

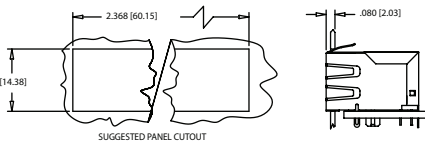
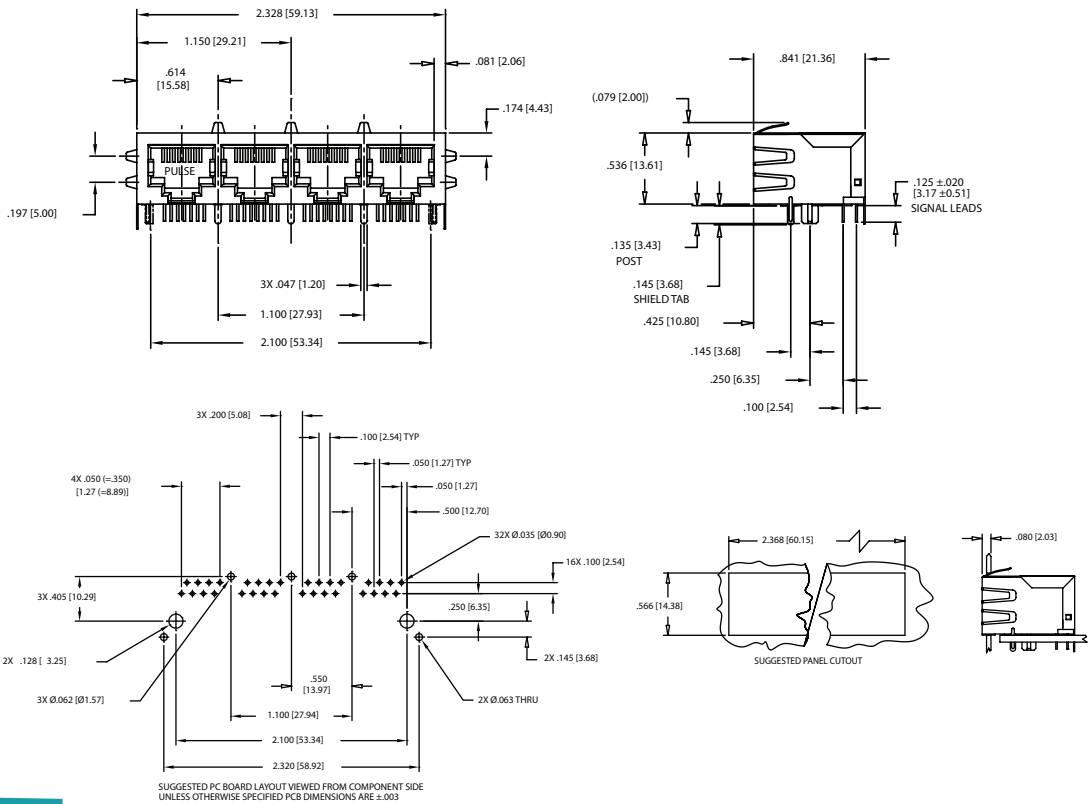

Mechanicals

J8064D668ANL, JX8064D668ANL

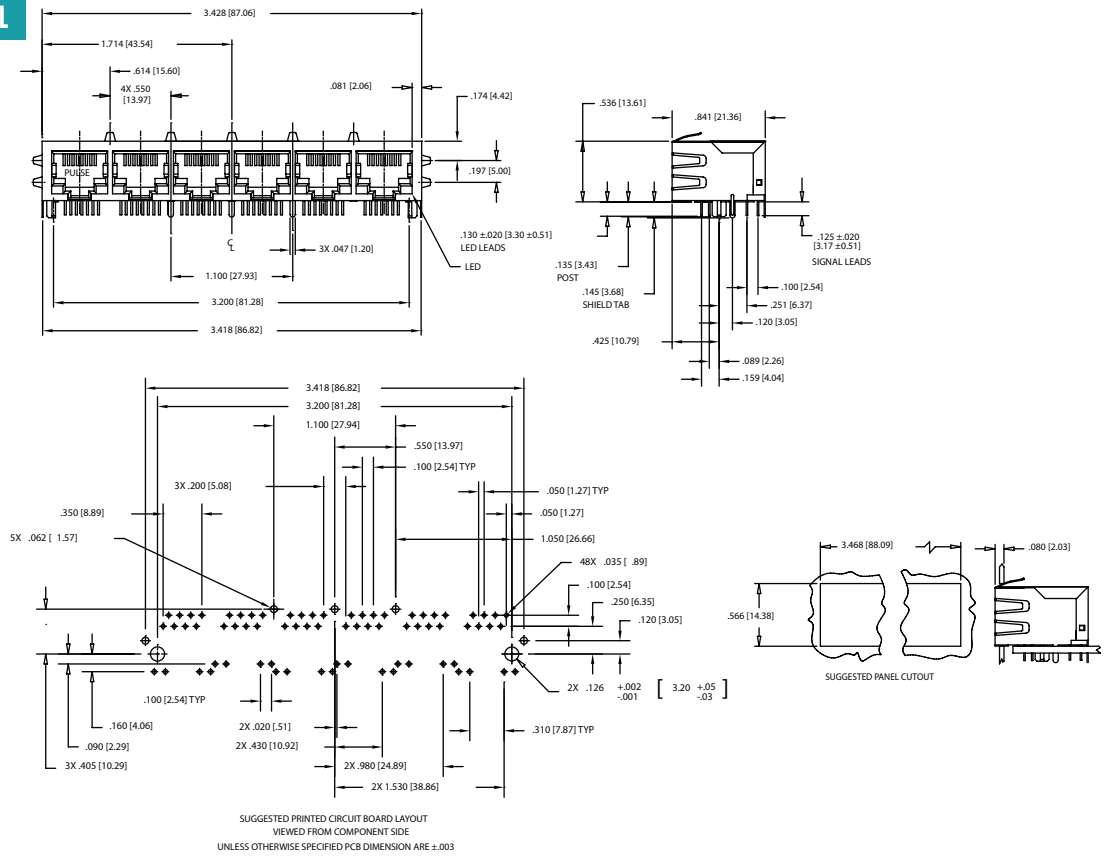

J8064E66NL

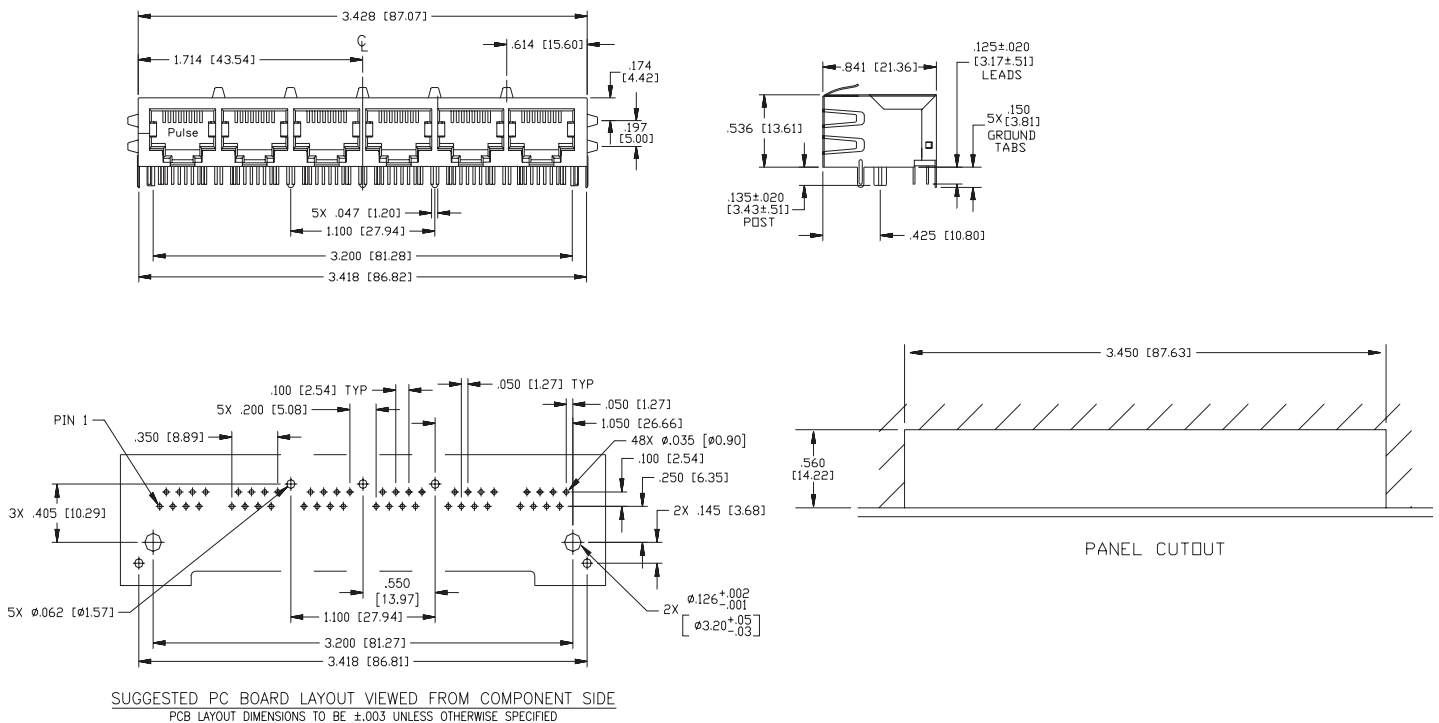

Mechanicals

J8064D688ANL, JX8064D688ANL

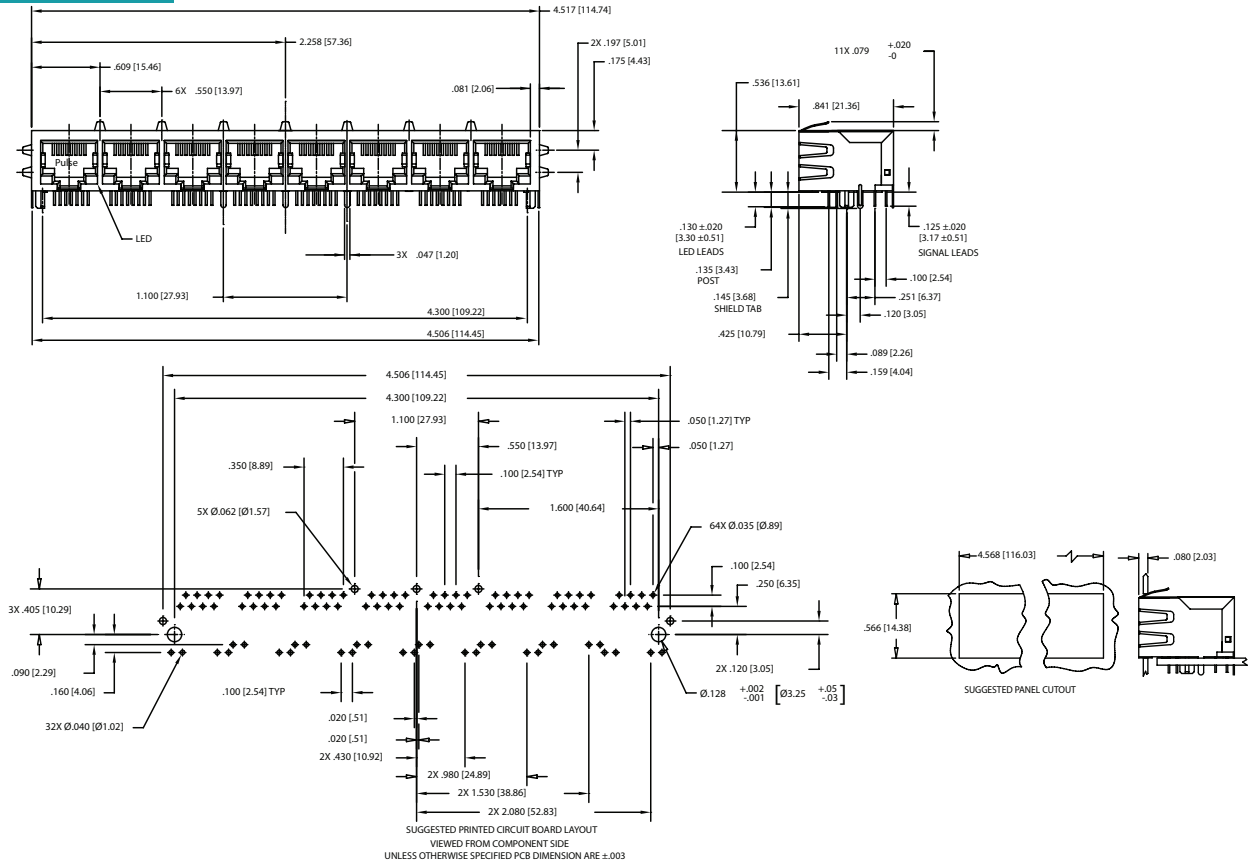

J8064E68NL

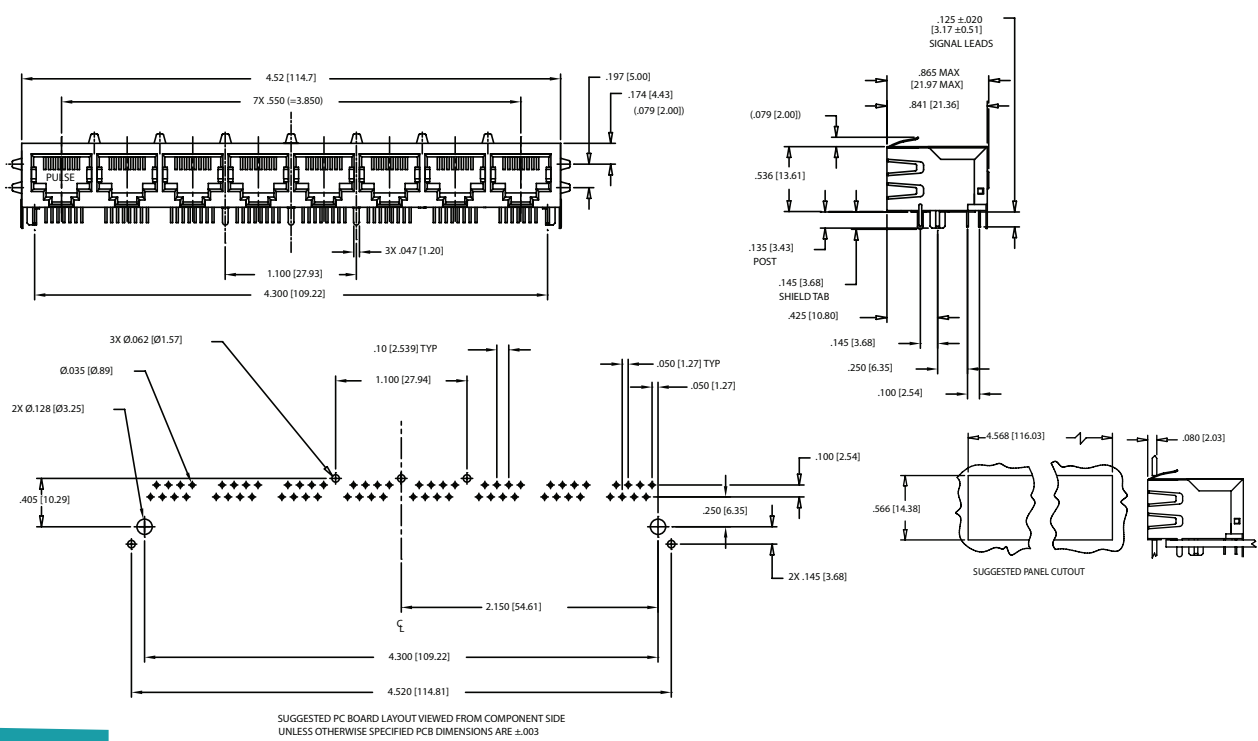

PulseJack™

1xN Tab-Down

Schematic for J8 and JX8 Series

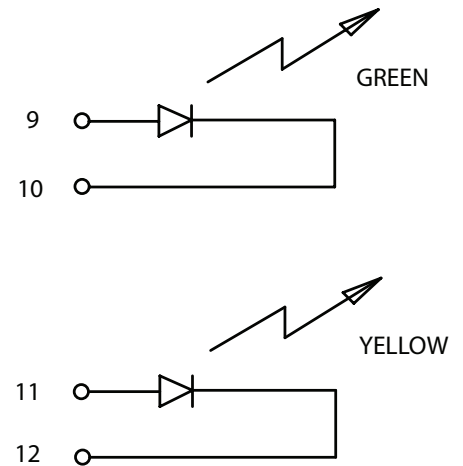
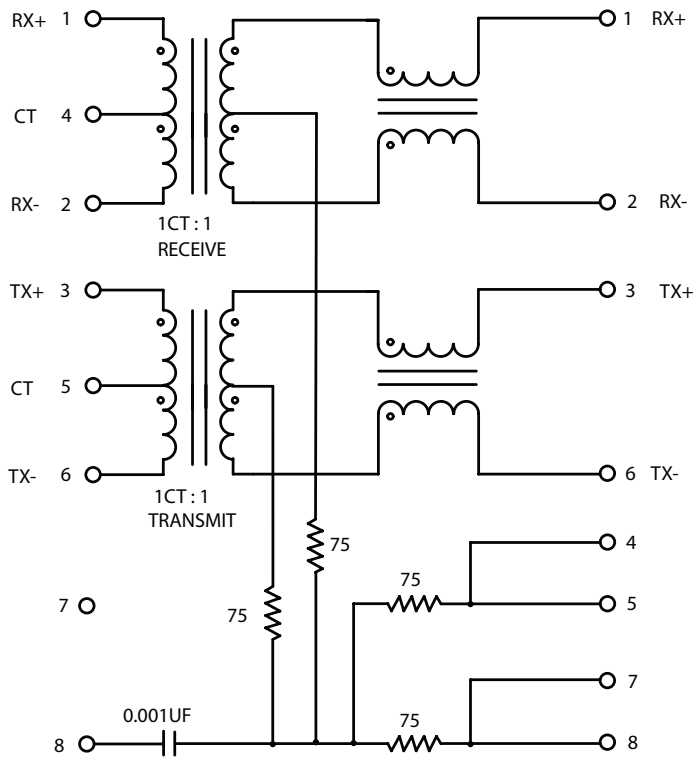

NOTE: JX80-0019NL and JX80-0022NL are Gree/Green

Configuration	1x2	1X4	1X6	1X8
Part Number	J8064D628ANL J8064E62NL	J8064D648ANL J8064E64NL	J8064D668ANL J8064E66NL	J8064D688ANL J8064E68NL
Weight	10.9 grams	21.8 grams	32.7 grams	43.6 grams
Tray	45/Tray	15/Tray	15/Tray	10/Tray

For More Information

Pulse Worldwide Headquarters
12220 World Trade Drive
San Diego, CA
92128
U.S.A.

Tel: 858 674 8100

Pulse Europe
Einsteinstrasse 1
D-71083 Herrenberg
Germany

Tel: 49 7032 7806

Pulse China Headquarters
B402, Shenzhen Academy of
Aerospace Technol-
ogy Bldg.
10th Kejinan Road
High-Tech Zone
Nanshan District
Shenzhen, PR China
518057

Pulse North China
Room 2704/2705
Super Ocean Finance
Ctr.
2067 Yan An Road
West
Shanghai 200336
China

Pulse South Asia
135 Joo Seng Road
#03-02
PM Industrial Bldg.
Singapore 368363

Tel: 65 6287 8998
Fax: 65 6287 8998

Pulse North Asia
3F, No. 198
Zhongyuan Road
Zhongli City
Taoyuan County 320
Taiwan R. O. C.
Tel: 886 3 4356768
Fax: 886 3 4356823
(Pulse)

Performance warranty of products offered on this data sheet is limited to the parameters specified. Data is subject to change without notice. Other brand and product names mentioned herein may be trademarks or registered trademarks of their respective owners. © Copyright, 2014. Pulse Electronics, Inc. All rights reserved.