

# 857141

## 1227.6 MHz SAW Filter

### Applications

- For GPS applications

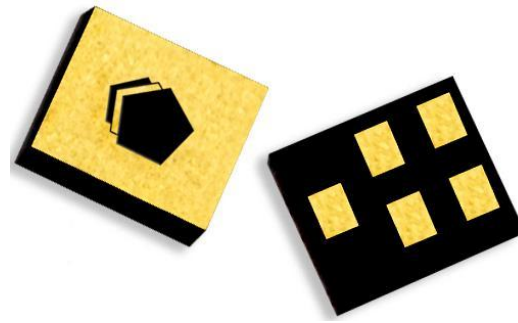

### Product Features

- Ultra-Low Loss
- Usable bandwidth 20.46 MHz
- Single-ended operation
- Ceramic chip-scale Package (CSP)
- Small Size: 1.40 x 1.20 x 0.46 mm
- Hermetically Sealed
- **RoHS** compliant, **Pb**-free

### General Description

857141 is specifically designed for GPS applications.

857141 uses advanced and inexpensive packaging techniques to achieve an extremely small 1.40 x 1.20 x 0.46 mm hermetically sealed package.

### Functional Block Diagram

Top view

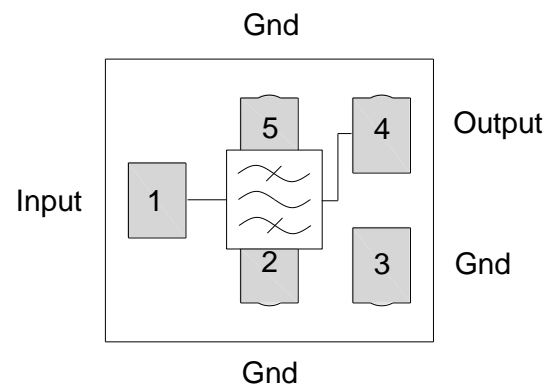

### Pin Configuration

Pin #	Balanced	Description
1		Input
4		Output
2,3,5		Ground

### Ordering Information

Part No.	Description
857141	packaged part
857141-EVB	evaluation board

Standard T/R size = 10000 units/reel.

## Specifications

### Electrical Specifications <sup>(1)</sup>

Specified Temperature Range: <sup>(2)</sup> -55 to +85 °C

Parameter <sup>(3)</sup>	Conditions	Min	Typical <sup>(4)</sup>	Max	Units
Center Frequency		-	1227.6	-	MHz
Maximum Insertion Loss	1226.4 – 1228.8 MHz	-	0.5	0.9	dB
Lower 2.0dB Bandedge		-	1211.53	1217.37	MHz
Upper 2.0dB Bandedge		1237.83	1250.42	-	MHz
Lower 21dB Bandedge		1177.6	1195.63	-	MHz
Upper 21dB Bandedge		-	1262.13	1277.6	MHz
Amplitude Variation	1226.4 – 1228.8 MHz	-	0.02	0.2	dB p-p
Relative Attenuation <sup>(5)</sup>	424 – 600 MHz	20	23.6	-	dB
	1150 – 1177.6 MHz	21	24.1	-	dB
	1277.6 – 1300 MHz	21	27.7	-	dB
	1360 – 1820 MHz	20	21.1	-	dB
Input Return Loss	1226.4 – 1228.8 MHz	15	26.8	-	dB
Output Return Loss	1226.4 – 1228.8 MHz	15	27.3	-	dB
Source Impedance (Single-ended) <sup>(6)</sup>		-	50	-	Ω
Load Impedance (Single-ended) <sup>(6)</sup>		-	50	-	Ω

Notes:

- All specifications are based on the TriQuint schematic for the main reference design shown on page 3
- In production, devices will be tested at room temperature to a guardbanded specification to ensure electrical compliance over temperature
- Electrical margin has been built into the design to account for the variations due to temperature drift and manufacturing tolerances
- Typical values are based on average measurements at room temperature
- Relative to zero dB.
- This is the optimum impedance in order to achieve the performance shown

### Absolute Maximum Ratings

Parameter	Rating
Operating Temperature <sup>(7)</sup>	-55 to +85 °C
Storage Temperature	-55to +85 °C
Input Power <sup>(8)</sup>	+20dBm

- Device may operate over this range with degraded Electrical Specifications
- Device is measured for equivalent 10K hours @ +85 °C [CW Signal]

Operation of this device outside the parameter ranges given above may cause permanent damage.

**Reference Design**

**Schematic**

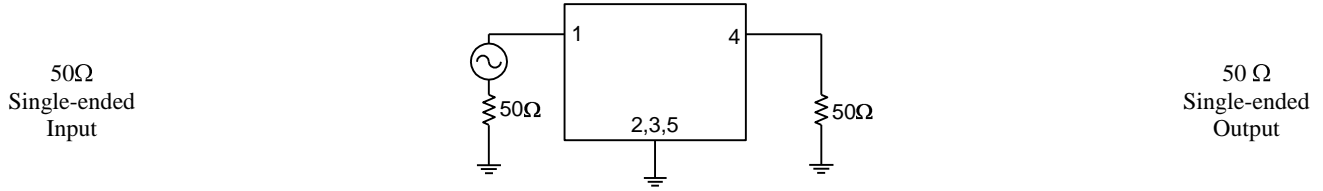

Notes:

1. Actual matching values may vary due to PCB layout and parasitic

**PC Board**

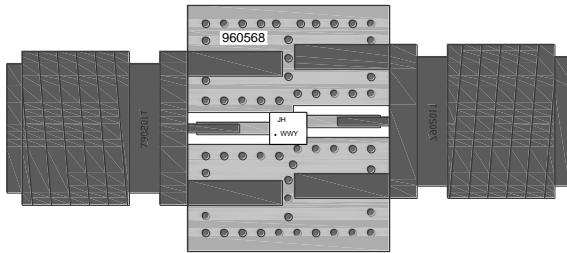

Notes:

- Top, middle & bottom layers: 1 oz copper
- Substrates: FR4 dielectric, .031" thick
- Finish plating: Nickel: 3-8μm thick, Gold: .03-.2μm thick
- Hole plating: Copper min .0008μm thick

**Mounting Configuration**

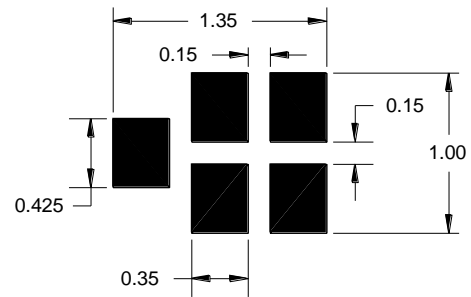

Notes:

1. All dimensions are in millimeters.
2. This footprint represents a recommendation only.

**Bill of Material**

Reference Desg.	Value	Description	Manufacturer	Part Number
SMA	N/A	SMA connector	Radiall USA Inc.	9602-1111-018
PCB	N/A	3-layer	multiple	960568

### Typical Performance (at room temperature)

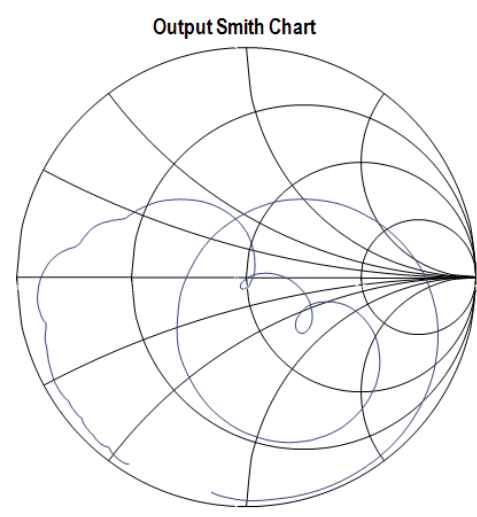
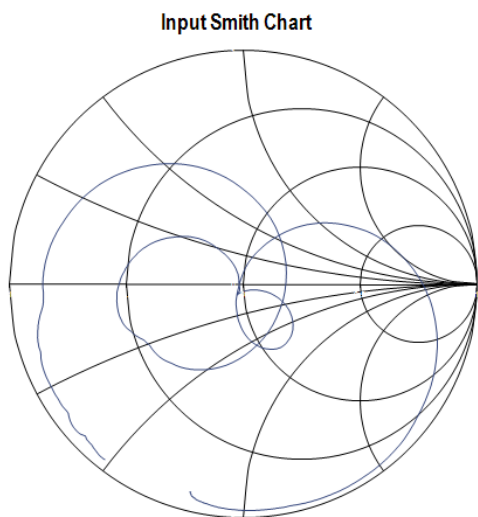
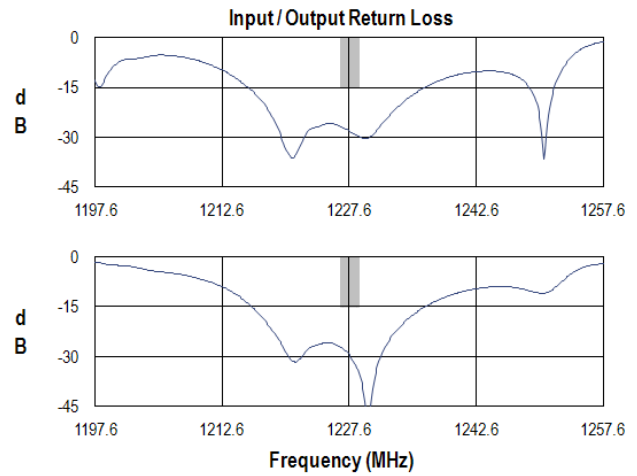
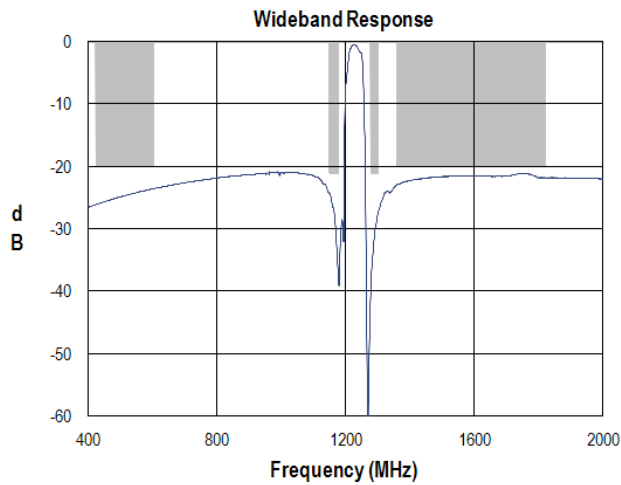
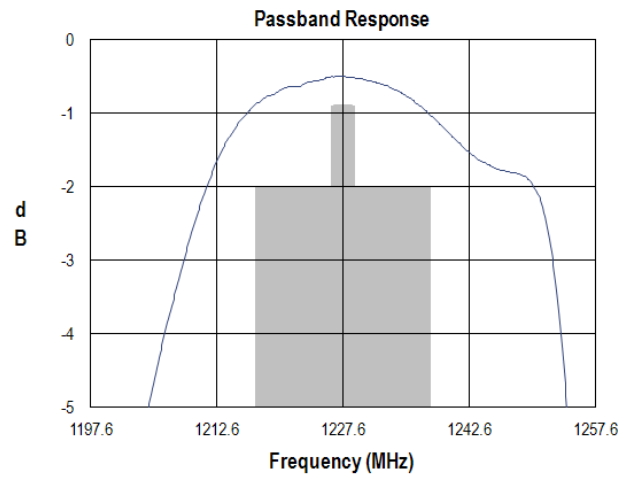
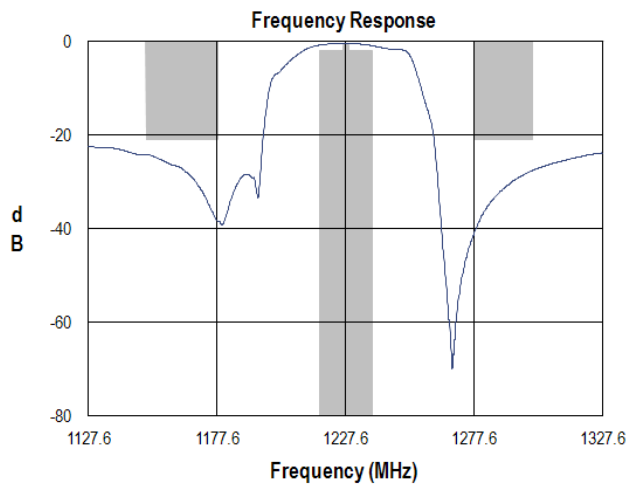

**Mechanical Information**

**Package Information, Dimensions and Marking**

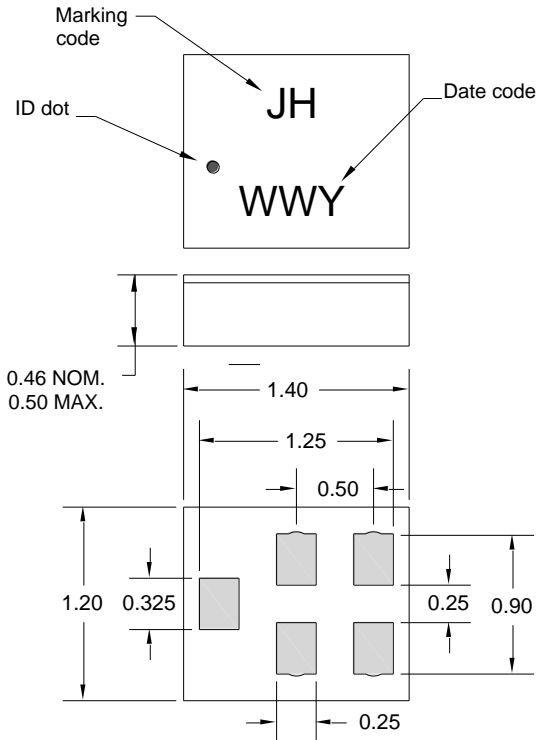

Package Style: CSP-5BT  
 Dimensions: 1.40 x 1.20 x 0.46 mm

Body:  $Al_2O_3$  ceramic  
 Lid: Kovar or Alloy 42, Au over Ni plated

Terminations: Au plating 0.5 - 1.0 $\mu$ m, over a 2-6 $\mu$ m Ni plating

All dimensions shown are nominal in millimeters  
 All tolerances are  $\pm 0.15$ mm except overall length and width  $\pm 0.10$ mm

The date code consists of: WW = 2 digit week and Y = last digit of year

**Tape and Reel Information**

Standard T/R size = 10000 units/reel. All dimensions are in millimeters

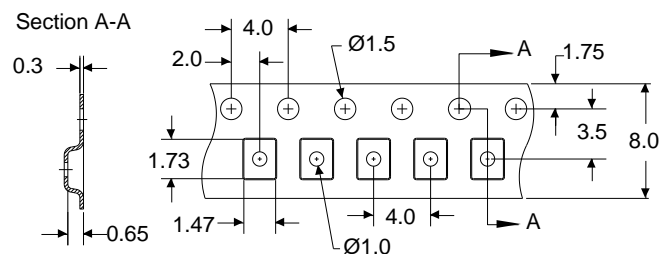
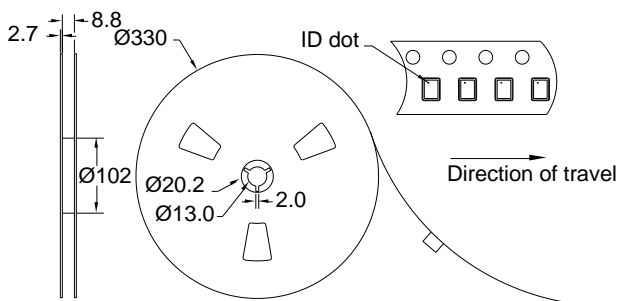

## Product Compliance Information

### ESD Information



#### Caution! ESD-Sensitive Device

ESD Rating: TBD

Value: Passes  $\geq$  TBD V min.  
Test: Human Body Model (HBM)  
Standard: JEDEC Standard JESD22-A114

ESD Rating: TBD

Value: Passes  $\geq$  TBD V min.  
Test: Machine Model (MM)  
Standard: JEDEC Standard JESD22-A115

### MSL Rating

Devices are Hermetic, therefore MSL is not applicable

### Solderability

Compatible with the latest version of J-STD-020, lead free solder, 260°C

Refer to [Soldering Profile](#) for recommended guidelines.

This part is compliant with EU 2002/95/EC RoHS directive (Restrictions on the Use of Certain Hazardous Substances in Electrical and Electronic Equipment).

This product also has the following attributes:

- Halogen Free (Chlorine, Bromine)
- Antimony Free
- TBBP-A (C<sub>15</sub>H<sub>12</sub>Br<sub>4</sub>O<sub>2</sub>) Free
- PFOS Free
- SVHC Free

## Contact Information

For the latest specifications, additional product information, worldwide sales and distribution locations, and information about TriQuint:

Web: [www.triquint.com](http://www.triquint.com)      Tel: +1.407.886.8860  
Email: [info-sales@tqs.com](mailto:info-sales@tqs.com)      Fax: +1.407.886.7061

For technical questions and application information:

Email: [flapplication.engineering@tqs.com](mailto:flapplication.engineering@tqs.com)

## Important Notice

The information contained herein is believed to be reliable. TriQuint makes no warranties regarding the information contained herein. TriQuint assumes no responsibility or liability whatsoever for any of the information contained herein. TriQuint assumes no responsibility or liability whatsoever for the use of the information contained herein. The information contained herein is provided "AS IS, WHERE IS" and with all faults, and the entire risk associated with such information is entirely with the user. All information contained herein is subject to change without notice. Customers should obtain and verify the latest relevant information before placing orders for TriQuint products. The information contained herein or any use of such information does not grant, explicitly or implicitly, to any party any patent rights, licenses, or any other intellectual property rights, whether with regard to such information itself or anything described by such information.

TriQuint products are not warranted or authorized for use as critical components in medical, life-saving, or life-sustaining applications, or other applications where a failure would reasonably be expected to cause severe personal injury or death.