

Applications

- PCS / 3G Base station / Repeaters
- WCDMA / LTE
- WiMax / WiBro
- ISM / Fixed Wireless
- HPA Feedback Paths

Product Features

- High Dynamic Range Mixer
- Integrated LO Driver
- +35 dBm Input IP3
- 8 dB Conversion Loss
- RF: 1500 – 3200 MHz
- LO: 1400 – 3500 MHz
- IF: 40 – 300 MHz
- +5 V Supply at 40 mA
- 0 dBm Drive Level
- RoHS-compliant MSOP8 (14 mm²)

General Description

The ML485 high linearity converter combines a passive GaAsFET mixer with an integrated LO driver in an ultra-small lead-free/green/RoHS-compliant MSOP-8 package. The double-balanced integrated IC is able to operate across a wide 1.5–3.2 GHz frequency range to achieve +35 dBm Input IP3 while drawing a very low 40mA current. The ML485 can be used as an up-converter or down-converter in a low-side or high-side LO configuration.

A LO buffer amplifier is integrated on the chip to allow for operation directly from a synthesizer requiring only 0 dBm of LO drive level. The dual-stage LO driver provides a stable input power level into the mixer to allow for consistent performance over a wide range of LO power levels. The converter requires no external baluns and supports a wide range of IF frequencies.

Typical applications include frequency up/down conversion, modulation and demodulation for receivers and transmitters used in 2.5G and 3G mobile infrastructure. Due to the wide frequency range of operation, the converter can also be used for WiMAX, WiBro, ISM, LTE and fixed wireless applications



MSOP 8 Package

Functional Block Diagram

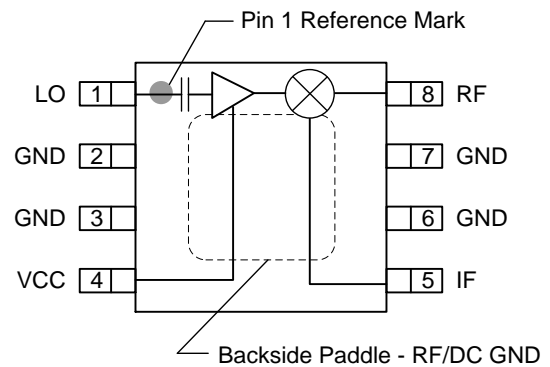

Pin Configuration

Pin No.	Symbol
1	LO
2, 3, 6, 7	GND
4	Vcc
5	IF
8	RF
Backside Paddle	GND

Ordering Information

Part No.	Description
ML485-G	1.5–3.2 GHz Mixer w/ Integrated LO Amp
ML485-PCB	Fully Assembled Evaluation Board

Standard T/R size = 1000 pieces on a 7" reel

Absolute Maximum Ratings

Parameter	Rating
Storage Temperature	-65 to +150 °C
DC Voltage	+7 V
Input IF / RF Power, CW, +25 °C	+27 dBm
LO Power	+10 dBm

Operation of this device outside the parameter ranges given above may cause permanent damage.

Recommended Operating Conditions

Parameter	Min	Typ	Max	Units
V _{CC}	+4.75	+5.0	+5.25	V
T _{CASE}	-40		+85	°C
T _j for >10 ⁶ hours MTTF			+150	°C

Electrical specifications are measured at specified test conditions. Specifications are not guaranteed over all recommended operating conditions.

Electrical Specifications

Test conditions unless otherwise noted: V_{CC} = +5 V, Temp = +25 °C, 50 Ω system. (see note 1)

Parameter	Min	Typ	Max	Min	Typ	Max	Min	Typ	Max	Min	Typ	Max	Units
RF Frequency Range	1700 – 1800			1800 – 2200			2300 – 2400			2500 – 2700			MHz
LO Frequency Range	1400 – 1750			1500 – 2150			2000 – 2350			2200 – 2650			MHz
IF Freq Range	40 – 300			40 – 300			40 – 300			40 – 300			MHz
SSB Conversion Loss		9.4			8.7	10		8.5			9		dB
Input IP3 (see note 2)	+28	+34		+30	+35			+37			+36		dBm
LO Leakage RF Port		-5			-2			-1			-1		dBm
LO Leakage IF Port		-11			-18			-25			-15		dBm
RF-IF Isolation		13			16			14			11		dB
RF Return Loss		13			13			15			16		dB
IF Return Loss		14			14			14			14		dB
LO Return Loss		10			10			12			13		dB
Input P1dB		+20			+20			+19.5			+19.5		dBm
LO Drive Level	-2	0	+4	-2	0	+4	-2	0	+4	-2	0	+4	dBm

Parameter	Min	Typ	Max	Units
Supply Voltage		+5		V
Supply Current		40		mA
Thermal Resistance (see note 3)			84	°C/W

Notes:

- Specifications are shown with 0dBm LO drive and IF = 200 MHz in a down converting configuration with a low-side LO.
- IIP3 is measured with Δf = 1 MHz with RFin = 0 dBm / tone.
- Thermal resistance is specified junction to case.

Performance Plots

Test conditions unless otherwise noted: $V_{CC} = +5\text{ V}$, $Temp = +25\text{ }^\circ\text{C}$, $50\ \Omega$ system.

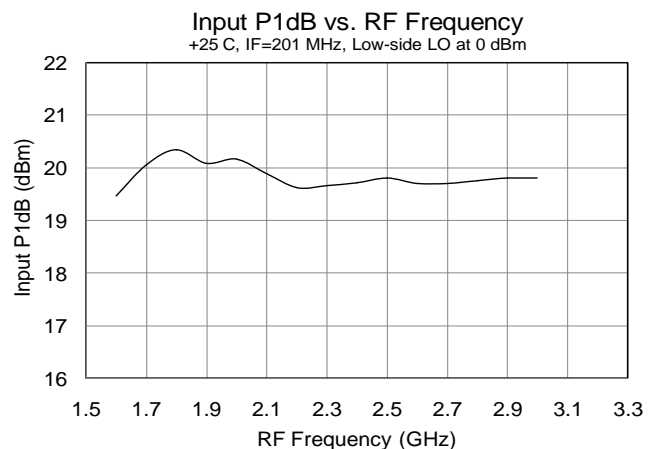
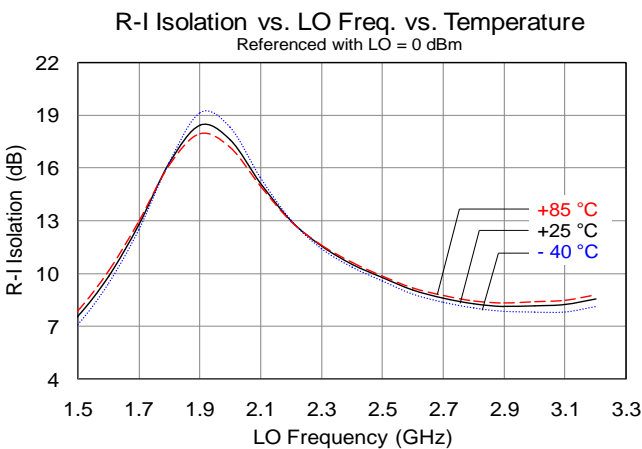
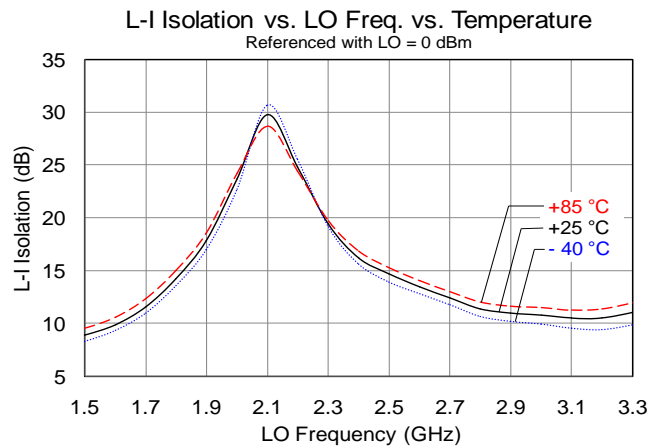
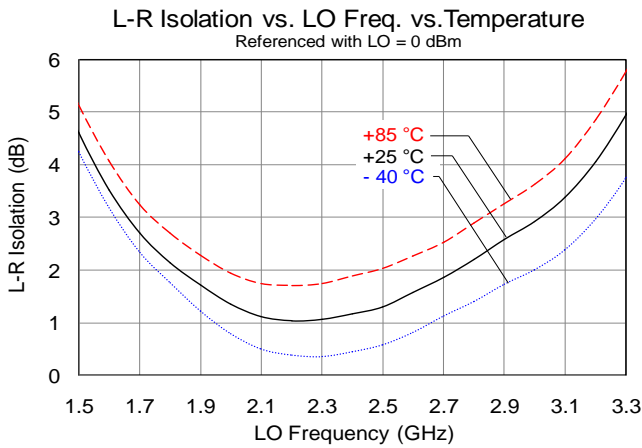
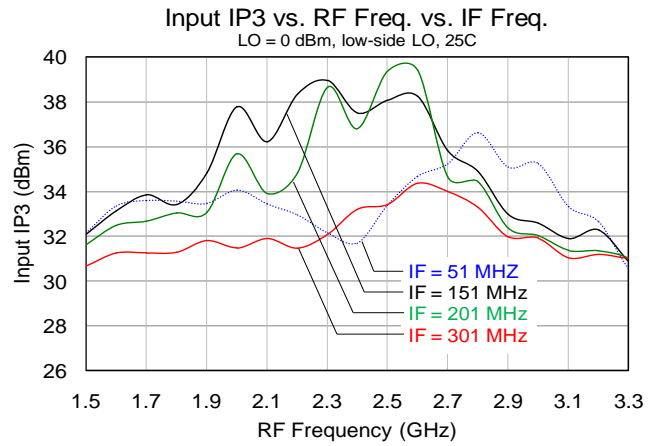
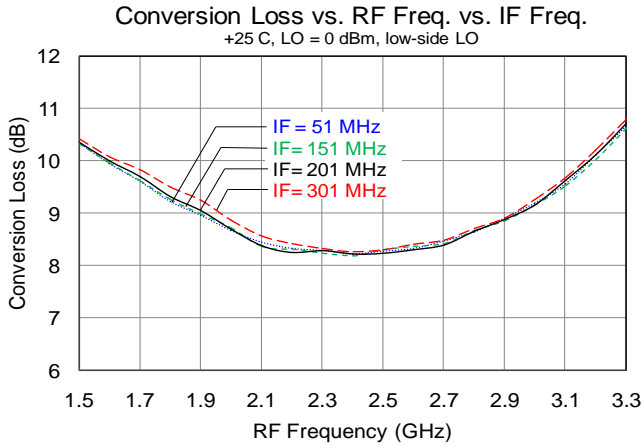

Performance Plots

Test conditions unless otherwise noted: $V_{CC} = +5\text{ V}$, $\text{Temp} = +25\text{ }^\circ\text{C}$, $50\ \Omega$ system.

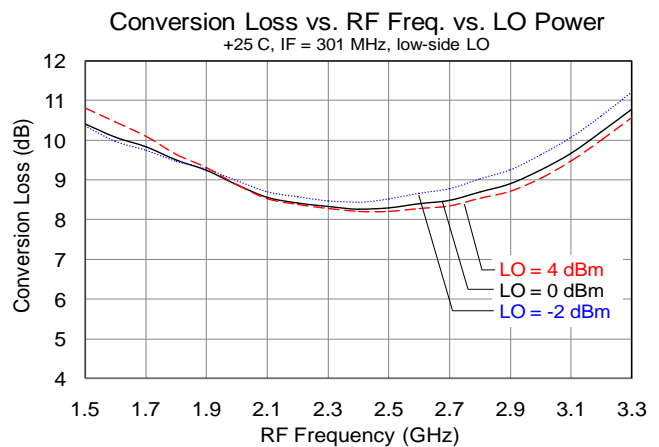
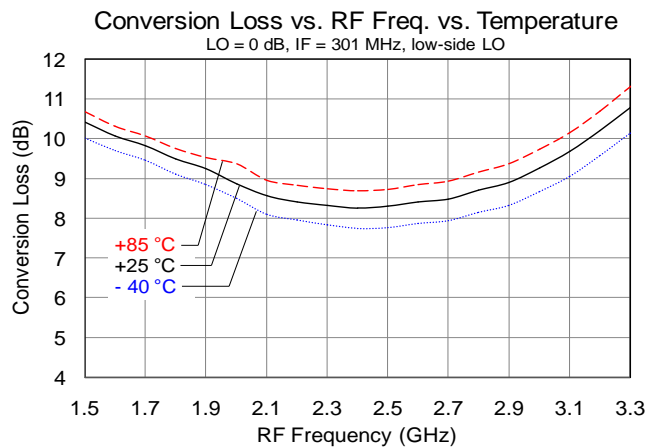
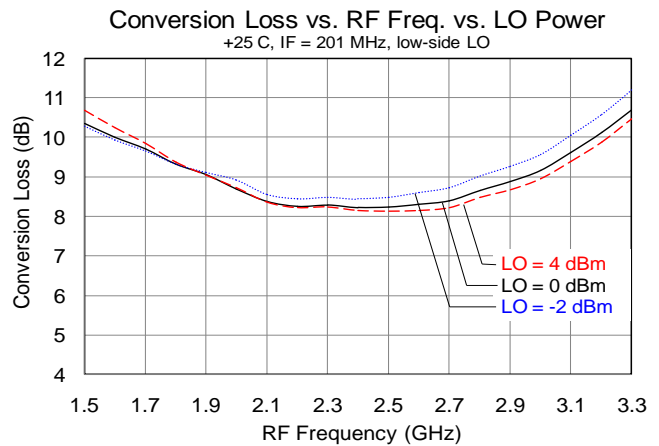
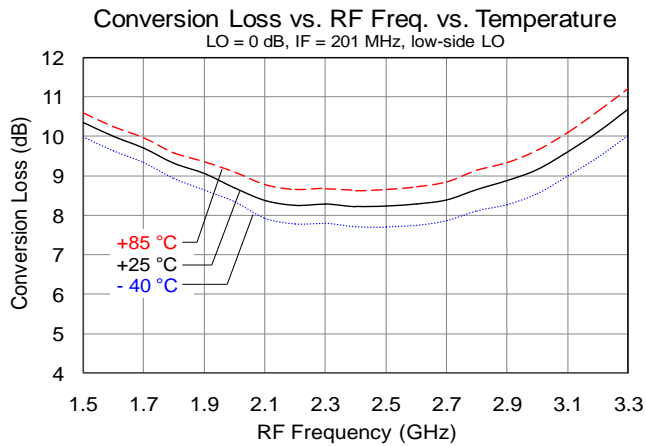
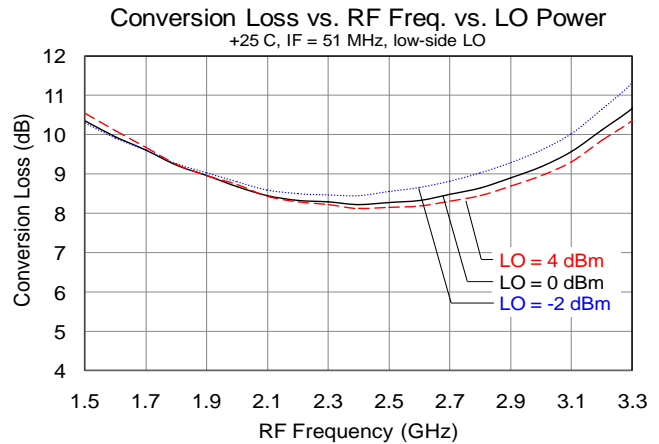
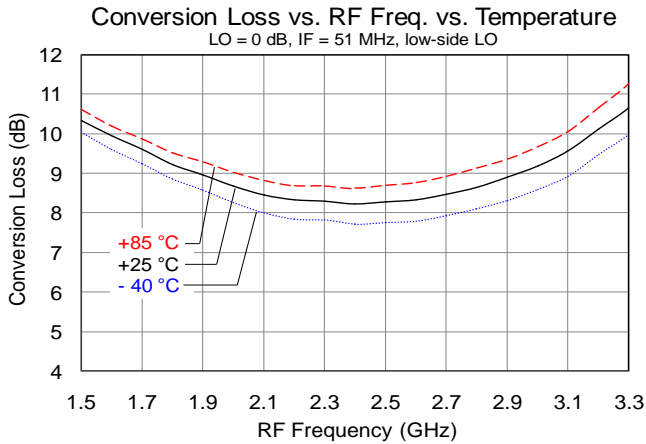

Performance Plots

Test conditions unless otherwise noted: $V_{CC} = +5\text{ V}$, $\text{Temp} = +25\text{ }^\circ\text{C}$, $50\ \Omega$ system.

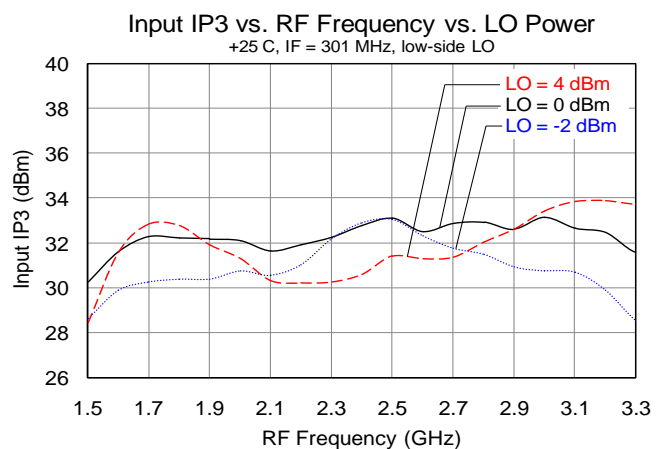
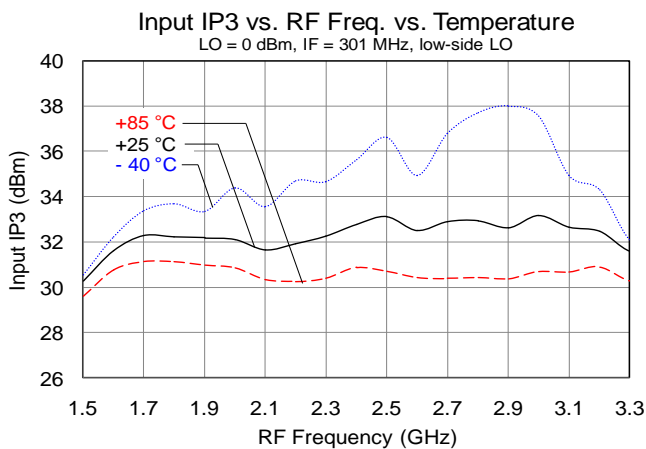
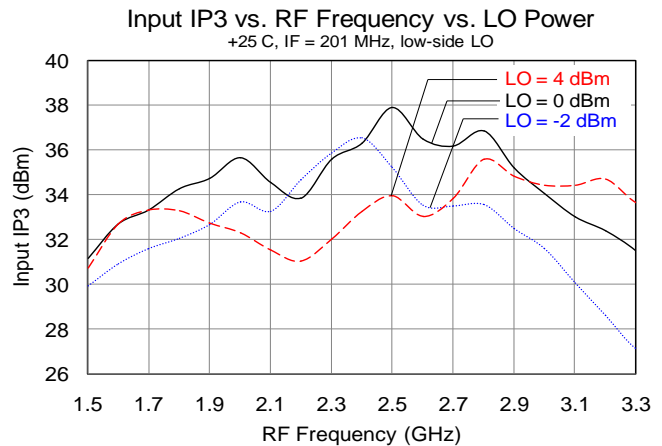
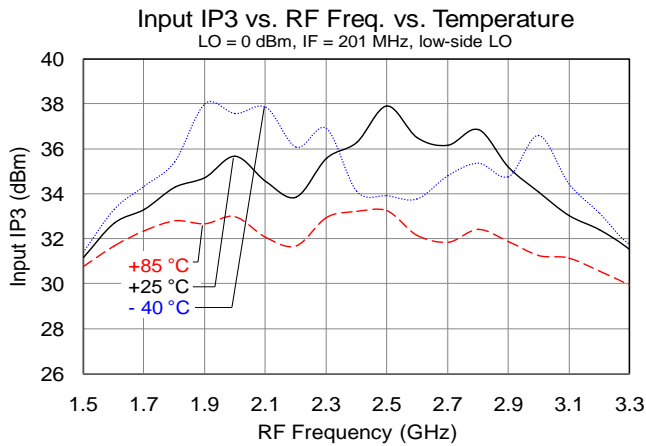
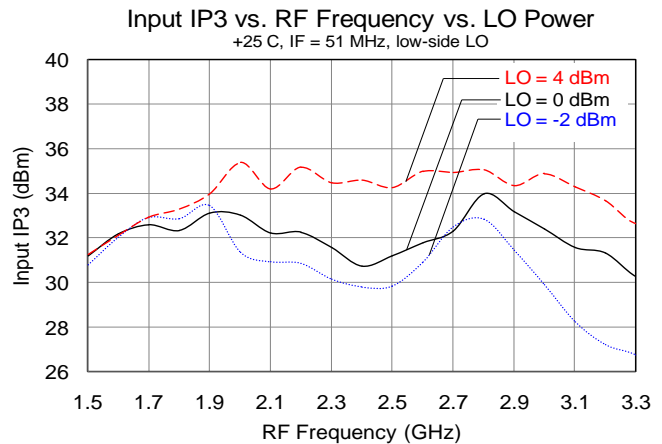
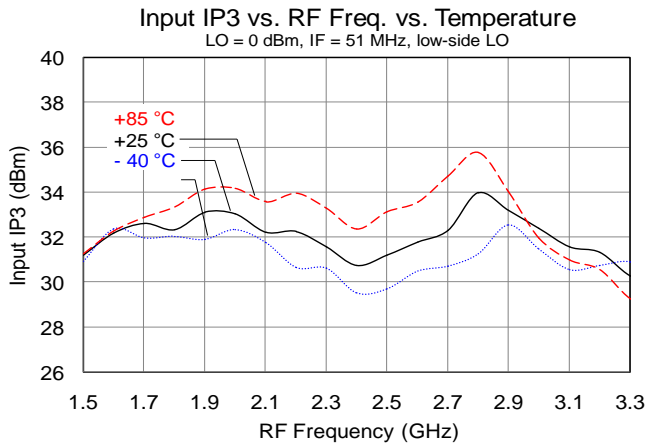

Performance Plots

Test conditions unless otherwise noted: $V_{CC} = +5\text{ V}$, $\text{Temp} = +25\text{ }^\circ\text{C}$, $50\ \Omega$ system.

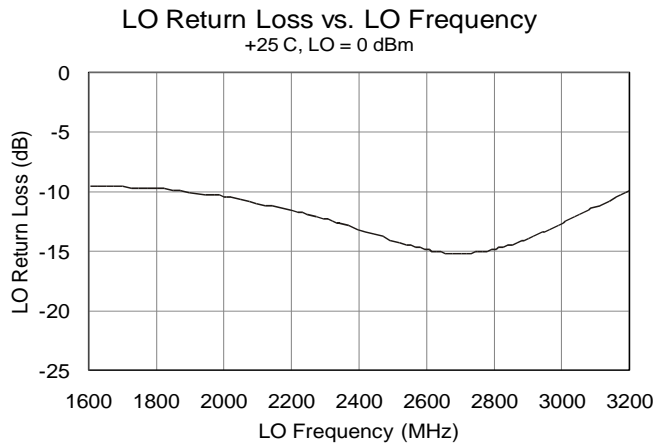
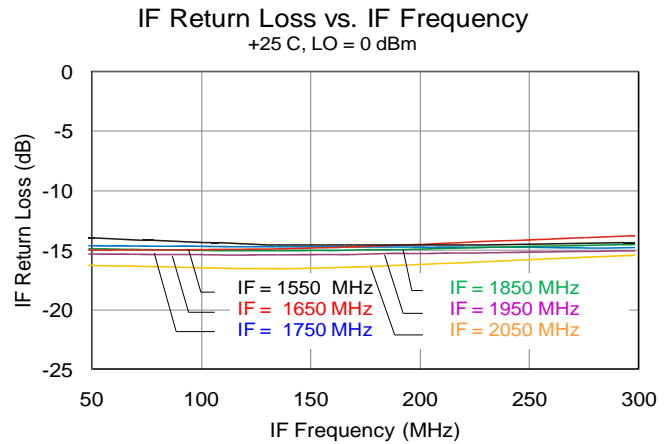
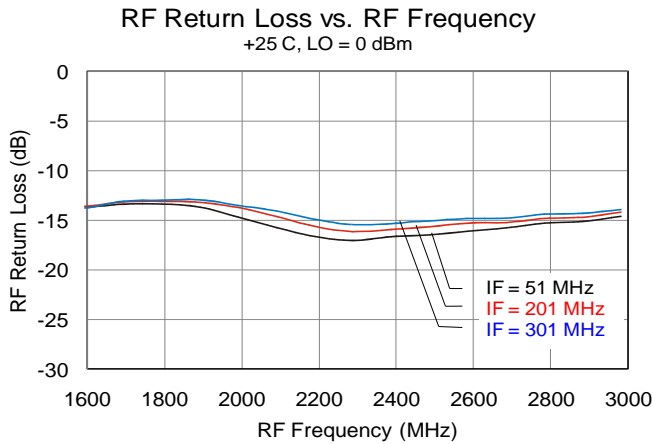

Spur Table

Spur table is $N \times f_{RF} - M \times f_{LO}$ mixer spurious products for 0 dBm input power, unless otherwise noted.
 RF Frequency = 1842 MHz, LO Frequency = 1642 MHz, All values in dBc relative to the IF Power Level.

		M					
		0	1	2	3	4	5
N	0		2	22	35	18	85
	1	3	0	30	23	47	35
	2	47	81	39	51	57	70
	3	87	80	94	72	78	81
	4	95	93	91	93	88	88
	5	95	95	95	92	95	95

Down Conversion Application Circuit: ML485-PCB

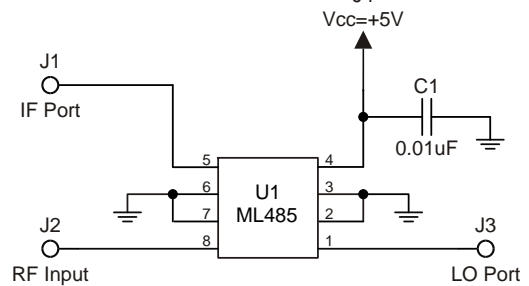
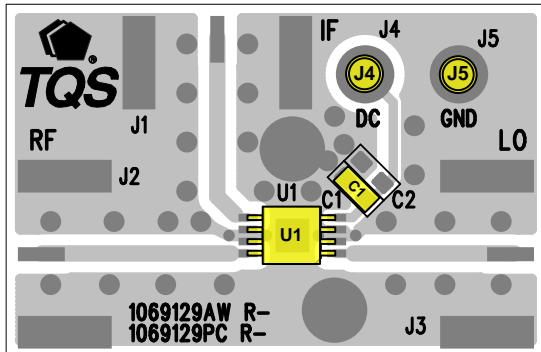

Pin Configuration and Description

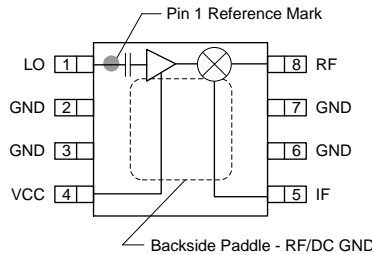

Pin No.	Symbol	Description
1	LO	Local Oscillator Injection. Internally DC Blocked
2, 3, 6, 7	GND	RF/DC Ground
4	Vcc	Supply voltage. An external bypass capacitor should be used near this pin.
5	IF	Intermediate Frequency
8	RF	Radio Frequency
Backside Paddle	GND	RF/DC Ground. Follow recommended via pattern and ensure good solder attach for best thermal and electrical performance.

Evaluation Board PCB Information

Qorvo PCB 1069129 Material and Stack-up

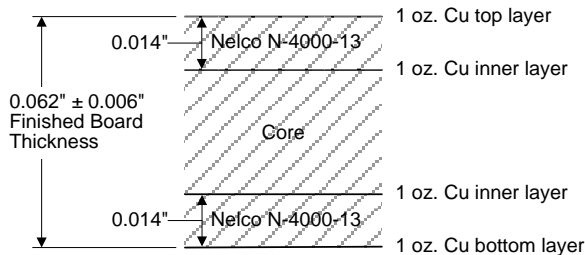

50 ohm line dimensions: width = 0.026", spacing = 0.025"

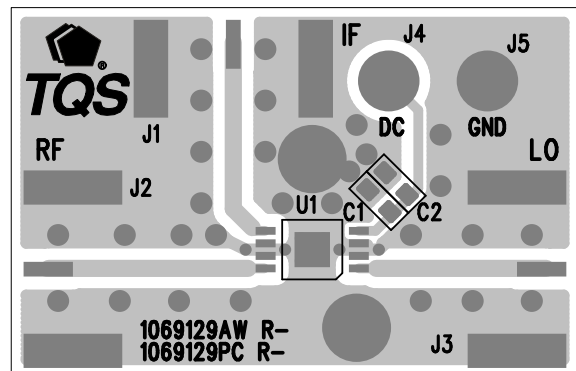

Package Marking and Dimensions

Marking: Part Code – M42
Lot Code – YXX

NOTES:

1. All dimensions are in millimeters. Angles are in degrees.
2. Except where noted, this part outline conforms to JEDEC standard MO-187.
3. Dimension and tolerance formats conform to ASME Y14.4M-1994.
4. The terminal #1 identifier and terminal numbering conform to JESD 95-1 SPP-012

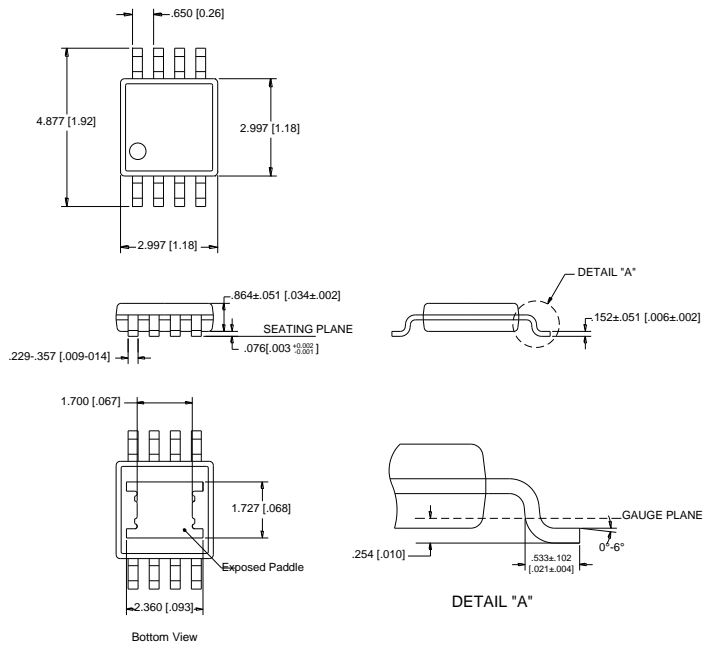

PCB Mounting Pattern

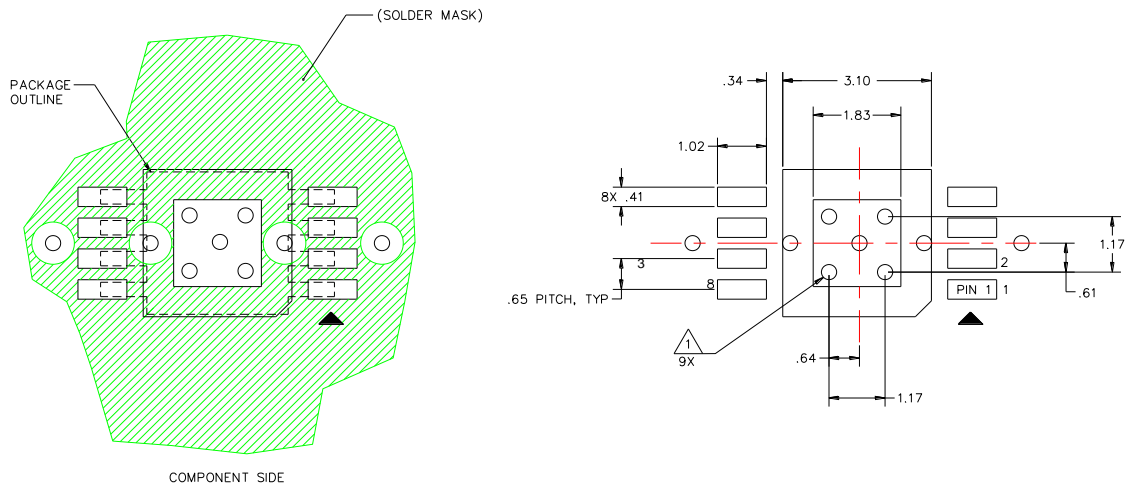

NOTES:

1. All dimensions are in millimeters. Angles are in degrees.
2. Use 1 oz. copper minimum for top and bottom layer metal.
3. We recommend a 0.35mm (#80/.0135") diameter bit for drilling via holes and a final plated thru diameter of 0.25 mm (0.10").
4. Ensure good package backside paddle solder attach for reliable operation and best electrical performance.

Product Compliance Information

ESD Sensitivity Ratings



Caution! ESD-Sensitive Device

ESD Rating: Class 0B
Value: ≥ 125 V to < 250 V
Test: Human Body Model (HBM)
Standard: ESDA/JEDEC Standard JS-001-2012

ESD Rating: Class C2
Value: ≥ 500 V to < 1000 V
Test: Charged Device Model (CDM)
Standard: JEDEC Standard JESD22-C101F

MSL Rating

MSL Rating: Level 2
Test: 260 °C convection reflow
Standard: JEDEC Standard IPC/JEDEC J-STD-020

Solderability

Compatible with both lead-free (260 °C maximum reflow temperature) and tin/lead (245 °C maximum reflow temperature) soldering processes.

Contact plating: Matte Tin

RoHS Compliance

This part is compliant with EU 2002/95/EC RoHS directive (Restrictions on the Use of Certain Hazardous Substances in Electrical and Electronic Equipment).

This product also has the following attributes:

- Lead Free
- Halogen Free (Chlorine, Bromine)
- Antimony Free
- TBBP-A (C₁₅H₁₂Br₄O₂) Free
- PFOS Free
- SVHC Free

Important Notice

For the latest specifications, additional product information, worldwide sales and distribution locations:

Web: www.triquint.com

Tel: 877-800-8584

Email: customer.support@qorvo.com

For information about the merger of RFMD and TriQuint as Qorvo:

Web: www.qorvo.com

For technical questions and application information:

Email: sjapplications.engineering@qorvo.com

Contact Information

The information contained herein is believed to be reliable. TriQuint makes no warranties regarding the information contained herein. TriQuint assumes no responsibility or liability whatsoever for any of the information contained herein. TriQuint assumes no responsibility or liability whatsoever for the use of the information contained herein. The information contained herein is provided "AS IS, WHERE IS" and with all faults, and the entire risk associated with such information is entirely with the user. All information contained herein is subject to change without notice. Customers should obtain and verify the latest relevant information before placing orders for TriQuint products. The information contained herein or any use of such information does not grant, explicitly or implicitly, to any party any patent rights, licenses, or any other intellectual property rights, whether with regard to such information itself or anything described by such information.

TriQuint products are not warranted or authorized for use as critical components in medical, life-saving, or life-sustaining applications, or other applications where a failure would reasonably be expected to cause severe personal injury or death.