

LED level meter driver, 5-point, VU scale

BA6124 / BA6124F

The BA6124 and BA6124F are driver ICs for LED VU level meters in stereo equipment and other display applications. The ICs display the input level (range: -10dB to $+6\text{dB}$) on a 5-point, bar-type LED display.

The circuit includes a rectifier amplifier allowing direct AC input, and has constant-current outputs, so it can directly drive the LEDs without variations in LED current due to power supply voltage fluctuations.

●Applications

VU meters, signal meters, and other display devices.

●Features

- 1) Rectifier amplifier allows either AC or DC input.
- 2) Constant-current outputs for constant LED current when the power supply voltage fluctuates.
- 3) Built-in reference voltage means that power supply voltage fluctuations do not effect the display.
- 4) Wide operating power supply voltage range (3.5V to 16V) for a wide range of applications.
- 5) Low PCB space requirements. Comes in a compact package and requires few external components.

●Absolute maximum ratings (Ta = 25°C)

Parameter		Symbol	Limits	Unit
Power supply voltage		V _{cc}	18	V
Power dissipation	BA6124	P _d	500*1	mW
	BA6124F		300*2	
Operating temperature		T _{opr}	$-25 \sim +60$	°C
Storage temperature		T _{stg}	$-55 \sim +125$	°C
Junction temperature		T _j	150	°C

*1 Reduced by 5mW for each increase in Ta of 1°C over 25°C.

*2 Reduced by 3mW for each increase in Ta of 1°C over 25°C.

●Block diagram

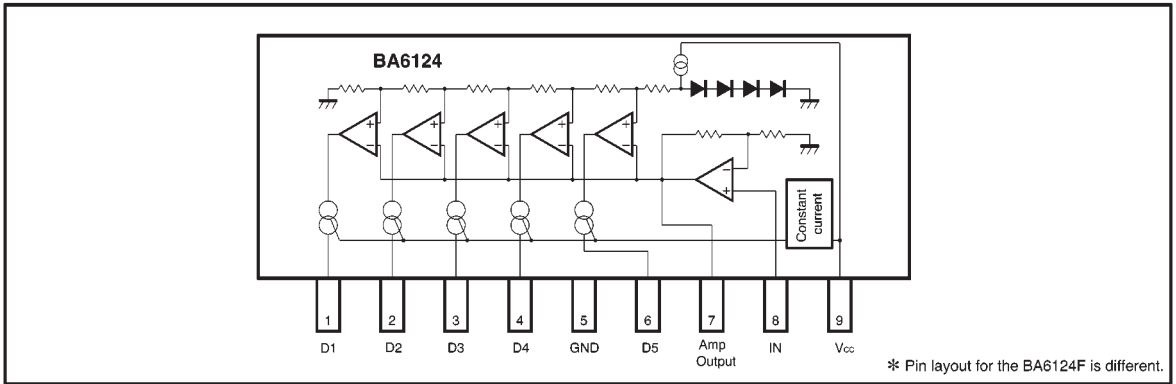

●Electrical characteristics (unless otherwise noted, $T_a = 25^\circ\text{C}$, $V_{CC} = 6.0\text{V}$, and $f = 1\text{kHz}$)

Parameter	Symbol	Min.	Typ.	Max.	Unit	Conditions
Power supply voltage	V_{CC}	3.5	6	16	V	—
Quiescent current	I_Q	—	5	8	mA	$V_{IN}=0\text{V}$
Comparator level 1	V_{C1}	-11.5	-10	-8.5	dB	—
Comparator level 2	V_{C2}	-6	-5	-4	dB	—
Comparator level 3	V_{C3}	—	0	—	dB	Adjustment point
Comparator level 4	V_{C4}	2.5	3	3.5	dB	—
Comparator level 5	V_{C5}	5	6	7	dB	—
Sensitivity	V_{IN}	74	85	96	mV _{rms}	V_{C3} on level
LED current	I_{LED}	11	15	18.5	mA	—
Input bias current	I_{NO}	—	0.3	1.0	μA	—

●Measurement circuit

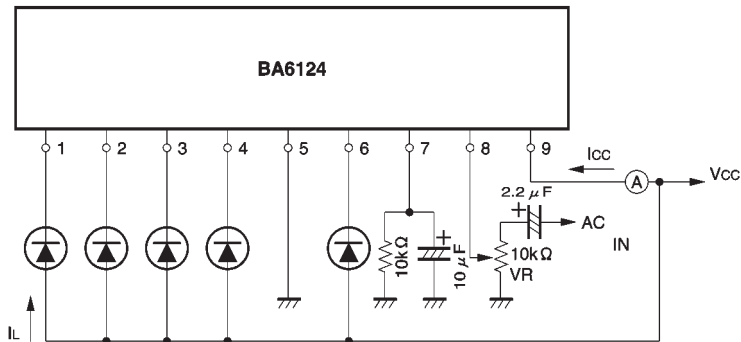

Fig. 1

●Electrical characteristics curves (Ta = 25°C)

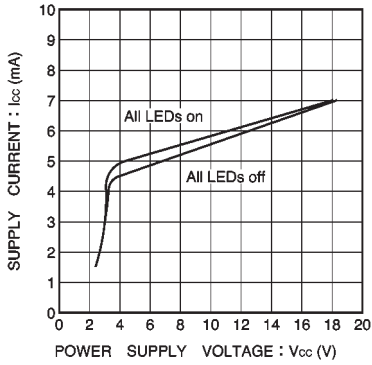

Fig. 2 Supply current vs. power supply voltage

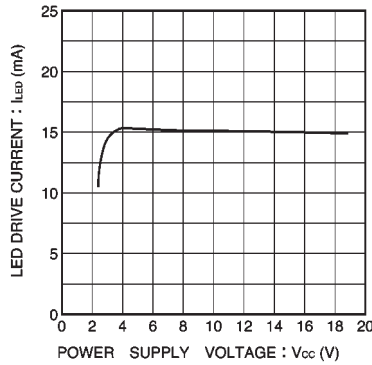

Fig. 3 LED drive current vs. power supply voltage

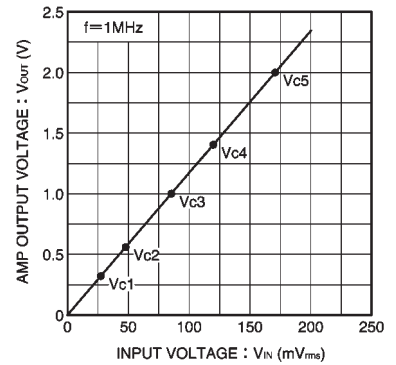

Fig. 4 Rectifier amplifier output voltage vs. input voltage

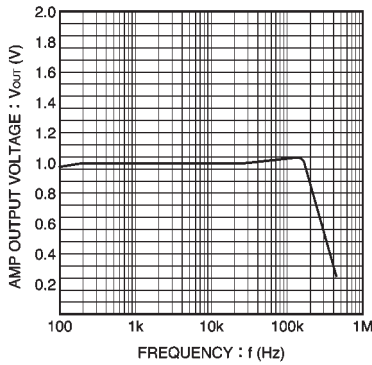

Fig. 5 Rectifier amplifier output voltage vs. frequency

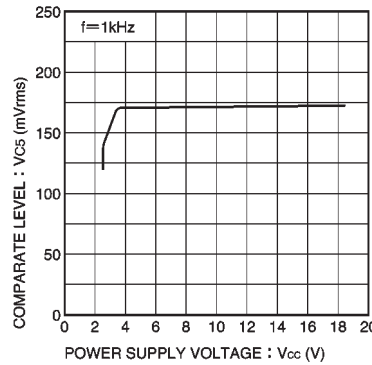

Fig. 6 Comparator level vs. power supply voltage

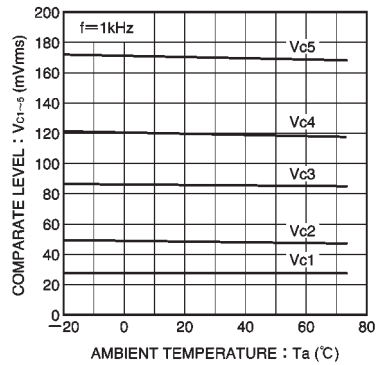

Fig. 7 Comparator level vs. ambient temperature

●External dimensions

