

DO NOT SCALE FROM THIS PRINT

TABLE 1	
LEAD STYLE	"A"
-02	.075 [1.91]
-03	.065 [1.65]

No OF POS PER ROW
-02 THRU -50

LEAD STYLE
-02: .075 [1.91]
(USE T-1S16-03-XX-2)
-03: .065 [1.65]
(USE T-1S16-03-XX-2)

PLATING SPECIFICATION
-L: 10µ" LIGHT SELECTIVE GOLD IN CONTACT AREA, MATTE TIN ON TAIL
-F: 3µ" FLASH SELECTIVE GOLD IN CONTACT AREA, MATTE TIN ON TAIL
-H: 30µ" HEAVY GOLD IN CONTACT AREA, 3µ" FLASH GOLD ON TAIL
-G: 10µ" GOLD IN CONTACT AREA, 3µ" FLASH GOLD ON TAIL
-LM: 10µ" LIGHT SELECTIVE GOLD IN CONTACT AREA, MATTE TIN ON TAIL
-FM: 3µ" FLASH SELECTIVE GOLD IN CONTACT AREA, MATTE TIN ON TAIL

OPTIONS
-P: PICK & PLACE PAD (USE PPP-30) (USE PPP-30-NIT FOR TAPE & REEL) (SEE FIG 3, SHT 4: 6 POS MIN)
-TR: TAPE & REEL PACKAGING
-ES: SNAP ON END SHROUDS (SEE FIG 2, SHT 2: 9 POS MIN) MOLD TO POSITION END SHROUDS (5 POS MIN; SEE FIG 2, SHT 2) (SAMTEC DISCRETION ON WHICH END SHROUDS ARE USED FOR POSITIONS -09 AND GREATER)
-EP: GUIDE POST (SEE FIG 4, SHT 4: 9 POS MIN) (USE ONLY WHEN MATING WITH A CLM)
-EC: LOCKING CLIP (SEE FIG 5, SHT 4) (SEE NOTE 9: 9 POS MIN)
-A: ALIGNMENT PIN (SEE FIG 6 & 7, SHT 5) (SAMTEC DISCRETION ON WHICH -A PIN IS USED) (MOLDED: 3 POS MIN, USE FTMH-75-D-XX) (STAKED: 7 POS MIN, USE FTMH-60-D)

ROW SPECIFICATION
-DV: DOUBLE ROW VERTICAL (USE FTMH-75-D)

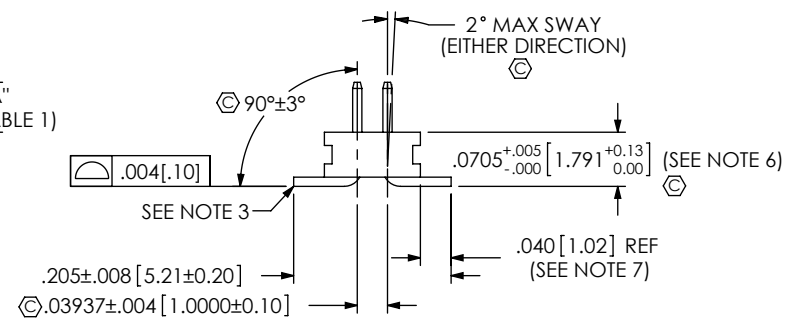
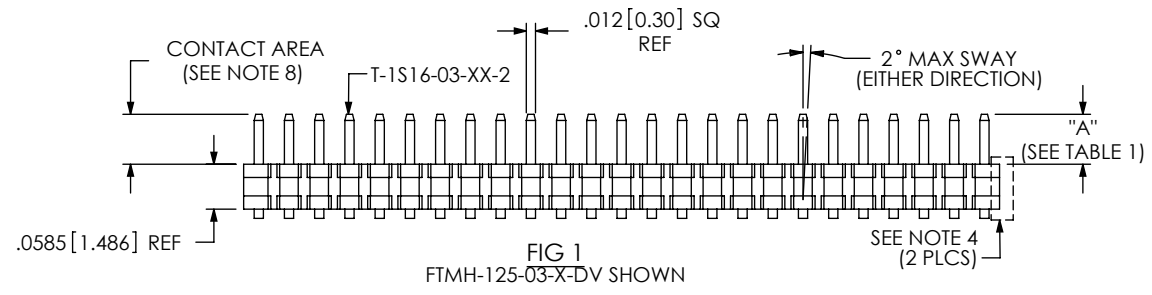
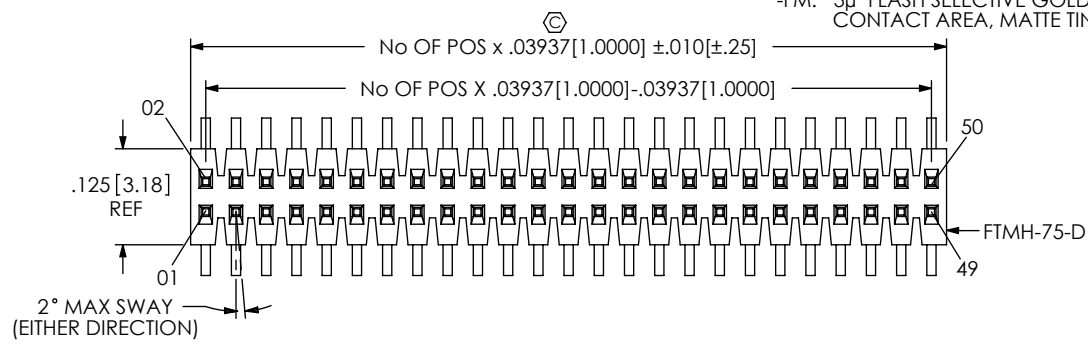

NOTES:

1. Ⓢ REPRESENTS CRITICAL DIMENSION.
2. MIN PUSHOUT FORCE: 1.0 LB = 16 OZ.
3. MAX BURR: .003 [0.08].
4. MAX CUT FLASH: .010 [0.25].
5. POSITIONS -02 THRU -04 TO BE LAYER PACKAGED.
6. MEASURED AT BEND RADIUS.
7. SHEAR TAILS TO DIMENSION SHOWN.
8. FOR SELECTIVE PLATING OPTIONS, GOLD PLATING TO BE ON POST, TIN PLATING TO BE ON TAIL.
9. DUE TO THE HIGH AMOUNT OF INSERTION FORCE NEEDED, THE -EC OPTION IS NOT COMPATIBLE WITH AUTO PLACEMENT. SAMTEC RECOMMENDS MANUAL PLACEMENT FOR ALL ASSEMBLIES WITH THE -EC OPTION.

UNLESS OTHERWISE SPECIFIED, DIMENSIONS ARE IN INCHES. TOLERANCES ARE: DECIMALS ANGLES .XX: ±.01 [.3] 1° .XXX: ±.005 [.13] .XXXX: ±.0010 [.025]	PROPRIETARY NOTE THIS DOCUMENT CONTAINS INFORMATION CONFIDENTIAL AND PROPRIETARY TO SAMTEC, INC. AND SHALL NOT BE REPRODUCED OR TRANSFERRED TO OTHER DOCUMENTS OR DISCLOSED TO OTHERS OR USED FOR ANY PURPOSE OTHER THAN THAT WHICH IT WAS OBTAINED WITHOUT THE EXPRESSED WRITTEN CONSENT OF SAMTEC, INC.		
		520 PARK EAST BLVD, NEW ALBANY, IN 47150 PHONE: 812-944-6733 FAX: 812-948-5047 e-Mail: info@SAMTEC.com code: 55322	
MATERIAL DO NOT SCALE DRAWING SHEET SCALE: 5:1		DESCRIPTION: 1mm x 1mm DOUBLE VERTICAL SMT TERMINAL STRIP	
INSULATOR: BLACK, LCP, UL-94-V-0 TERMINAL: PHOSPHOR BRONZE		DWG. NO. FTMH-1XX-XX-XX-DV-XX	
F:\DWG\MISC\MKTG\FTMH-1XX-XX-XX-DV-XX-MKT.SLDDRW		BY: PURVIS 04-22-96	SHEET 1 OF 5

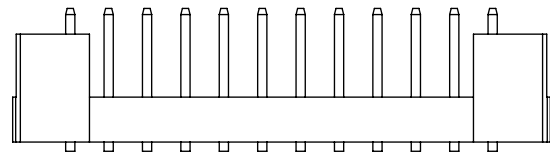
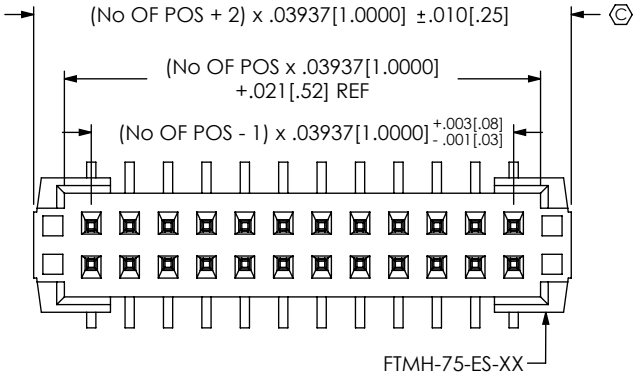
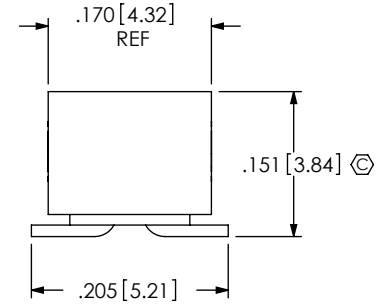
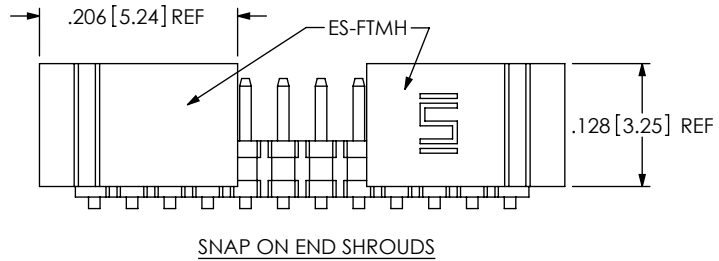
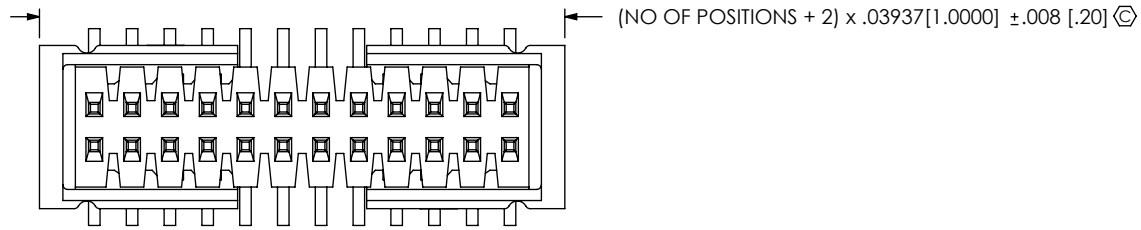

MOLDED TO POSITION END SHROUDS

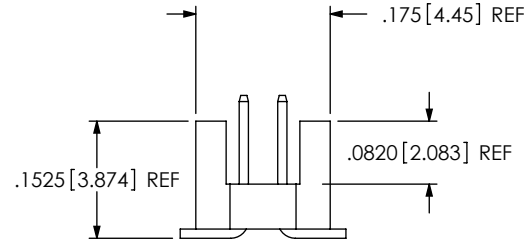



FIG 2
-ES: END SHROUDS
FTMH-112-02-X-DV-ES SHOWN
(DIFFERENT AS SHOWN, OTHERWISE SAME AS FIG 1)

PROPRIETARY NOTE
THIS DOCUMENT CONTAINS INFORMATION
CONFIDENTIAL AND PROPRIETARY TO
SAMTEC, INC. AND SHALL NOT BE REPRODUCED
OR TRANSFERRED TO OTHER DOCUMENTS OR
DISCLOSED TO OTHERS OR USED FOR ANY
PURPOSE OTHER THAN THAT WHICH IT WAS
OBTAINED WITHOUT THE EXPRESSED WRITTEN
CONSENT OF SAMTEC, INC.

DO NOT SCALE DRAWING

SHEET SCALE: 5:1

 520 PARK EAST BLVD, NEW ALBANY, IN 47150 PHONE: 812-944-6733 FAX: 812-948-5047 e-Mail: info@SAMTEC.com code: 55322	
DESCRIPTION: 1mm x 1mm DOUBLE VERTICAL SMT TERMINAL STRIP	
DWG. NO. FTMH-1XX-XX-XX-DV-XX	
BY: PURVIS	04-22-96
SHEET 2 OF 5	

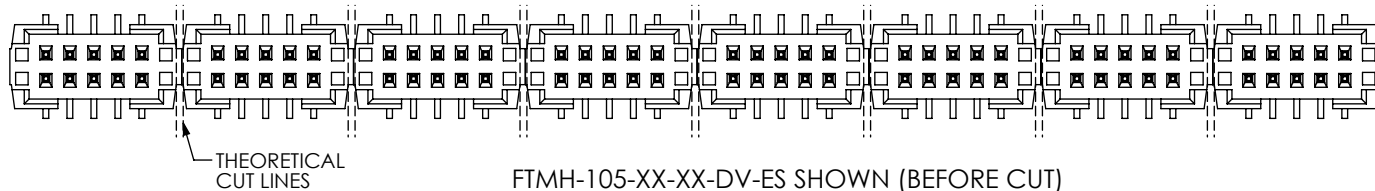

FTMH-105-XX-XX-DV-ES SHOWN (BEFORE CUT)

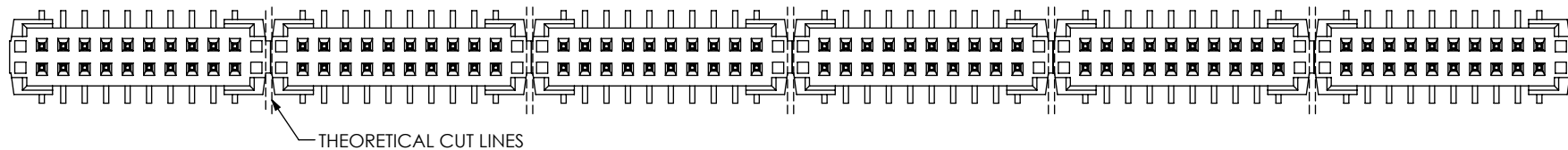

FTMH-110-XX-XX-DV-ES SHOWN (BEFORE CUT)

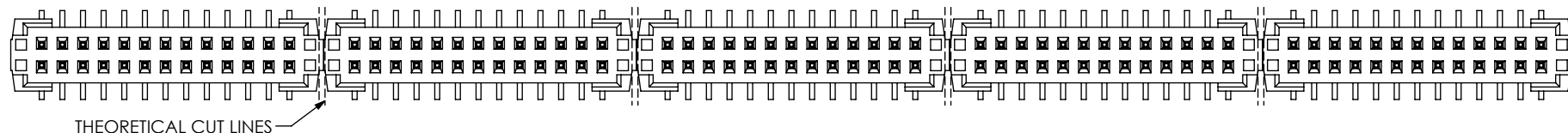

FTMH-113-XX-XX-DV-ES SHOWN (BEFORE CUT)

PROPRIETARY NOTE
 THIS DOCUMENT CONTAINS INFORMATION
 CONFIDENTIAL AND PROPRIETARY TO
 SAMTEC, INC. AND SHALL NOT BE REPRODUCED
 OR TRANSFERRED TO OTHER DOCUMENTS OR
 DISCLOSED TO OTHERS OR USED FOR ANY
 PURPOSE OTHER THAN THAT WHICH IT WAS
 OBTAINED WITHOUT THE EXPRESSED WRITTEN
 CONSENT OF SAMTEC, INC.

DO NOT SCALE DRAWING

SHEET SCALE: 5:1



520 PARK EAST BLVD, NEW ALBANY, IN 47150
 PHONE: 812-944-6733 FAX: 812-948-5047
 e-Mail: info@SAMTEC.com code: 55322

DESCRIPTION:
 1mm x 1mm DOUBLE VERTICAL SMT TERMINAL STRIP

DWG. NO.
FTMH-1XX-XX-XX-DV-XX

BY: PURVIS 04-22-96 SHEET 3 OF 5

NOTE
 "M" = USED MEASURED DIMENSION (REF)
 "P" = $(("M" - .200[5.08]) / 2) \pm .020[.51]$

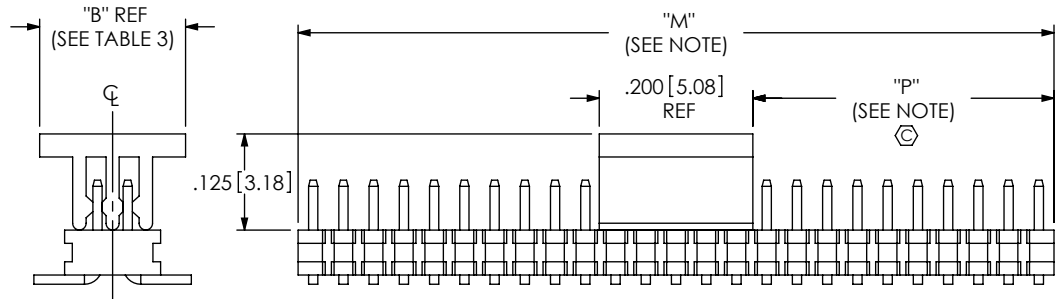

FIG 3
 -P: PICK & PLACE PAD
 FTMH-125-03-X-DV-P SHOWN
 (DIFFERENT AS SHOWN, OTHERWISE SAME AS FIG 1)

TABLE 3	
PAD	"B"
PPP-30	.125[3.18]
PPP-30-NT	.190[4.83]

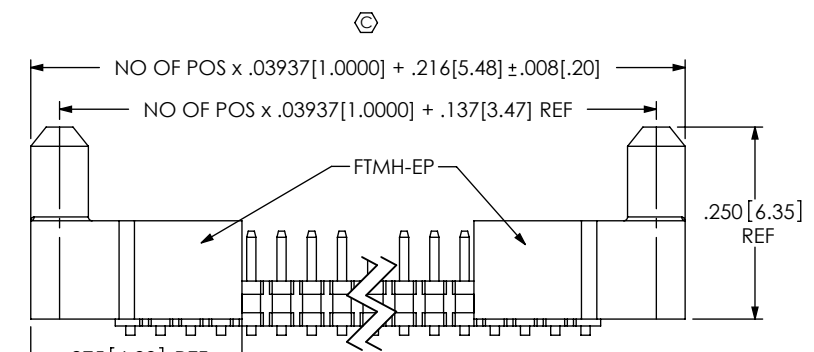

FIG 4
 -EP: GUIDE POST
 FTMH-125-03-X-DV-EP SHOWN
 (DIFFERENT AS SHOWN, OTHERWISE SAME AS FIG 1)

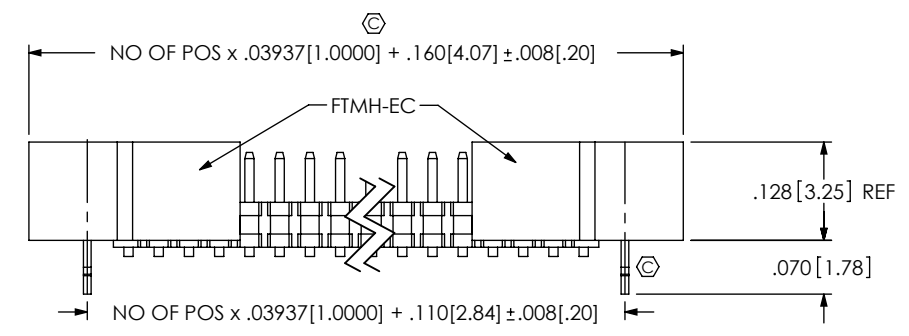
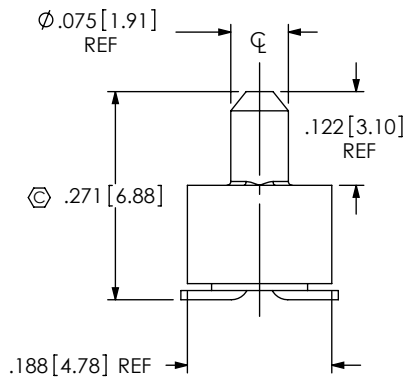
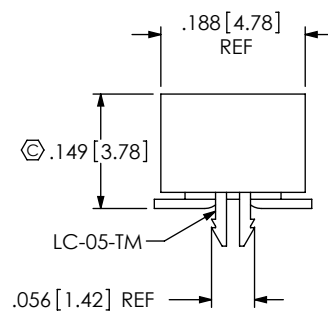

FIG 5
 -EC: LOCKING CLIP
 FTMH-125-03-X-DV-EC SHOWN
 (DIFFERENT AS SHOWN, OTHERWISE SAME AS FIG 1)



PROPRIETARY NOTE
 THIS DOCUMENT CONTAINS INFORMATION
 CONFIDENTIAL AND PROPRIETARY TO
 SAMTEC, INC. AND SHALL NOT BE REPRODUCED
 OR TRANSFERRED TO OTHER DOCUMENTS OR
 DISCLOSED TO OTHERS OR USED FOR ANY
 PURPOSE OTHER THAN THAT WHICH IT WAS
 OBTAINED WITHOUT THE EXPRESSED WRITTEN
 CONSENT OF SAMTEC, INC.

DO NOT SCALE DRAWING

SHEET SCALE: 5:1



520 PARK EAST BLVD, NEW ALBANY, IN 47150
 PHONE: 812-944-6733 FAX: 812-948-5047
 e-Mail: info@SAMTEC.com code: 55322

DESCRIPTION:
 1mm x 1mm DOUBLE VERTICAL SMT TERMINAL STRIP

DWG. NO.
FTMH-1XX-XX-XX-DV-XX

BY: PURVIS 04-22-96 SHEET 4 OF 5

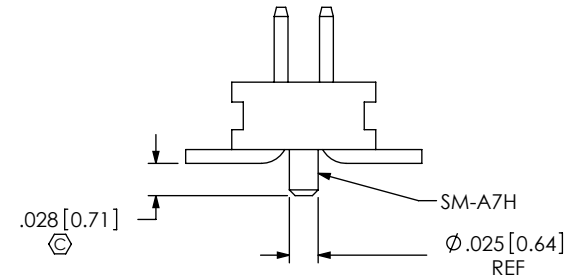
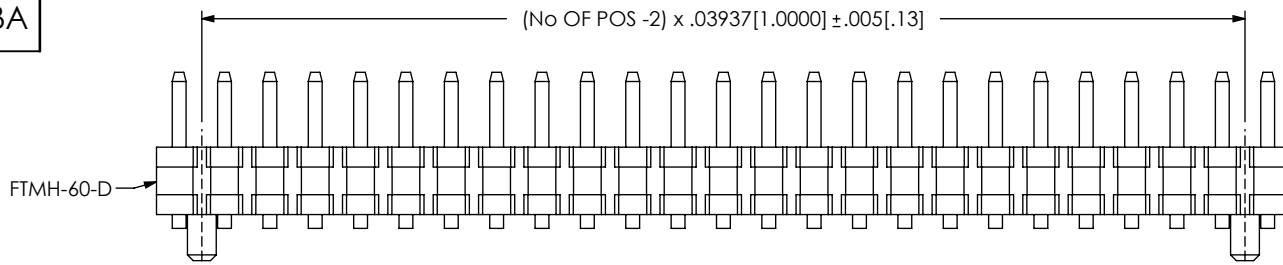

FIG 6
 -A: ALIGNMENT PIN (STAKED)
 (MIN 7 POSITIONS)
 FTMH-125-03-X-DV-A SHOWN
 (DIFFERENT AS SHOWN, OTHERWISE SAME AS FIG 1)

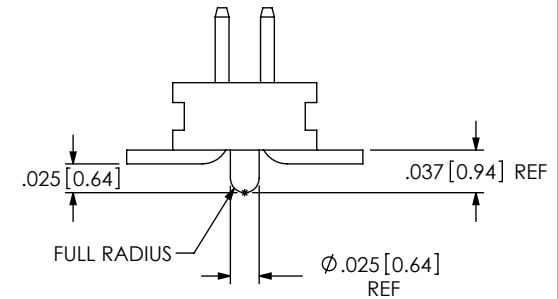
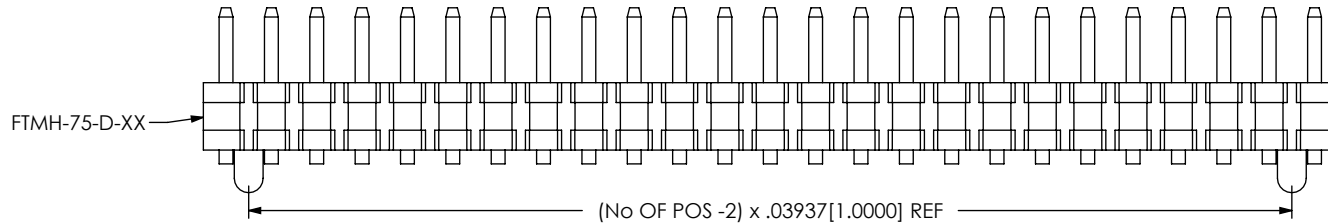
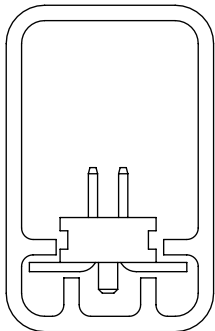
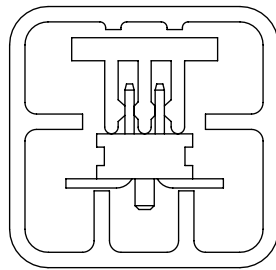

FIG 7
 -A: ALIGNMENT PIN (MOLDED)
 (MIN 3 POSITIONS)
 FTMH-125-03-X-DV-A SHOWN
 (DIFFERENT AS SHOWN, OTHERWISE SAME AS FIG 1)



-A OPTION
 PT-T-24-01-60



-A-P OPTION
 PT-T-24-05-63

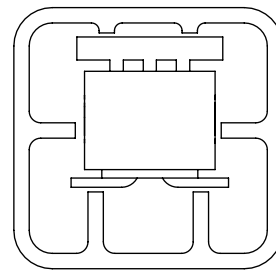

-ES-P OPTION
 PT-T-24-01-63

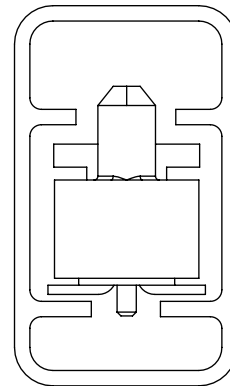

-EP-A-P OPTION
 PT-T-24-02-15

PACKAGING VIEWS

TABLE 2 (SEE NOTE 5 FOR PACKAGING NOTES)			
LEAD STYLE	OPTION (S)	PACKAGING TUBE	TUBE PLUG
-02, -03	-NONE	PT-1-24-01-60	TP-03 (x 2)
-02, -03	-A	PT-1-24-01-60	TP-03 (x 2)
-02, -03	-P, -A-P	PT-1-24-05-63	TP-24 (x 2)
-02, -03	-ES, -ES-P, -ES-A, EP	PT-1-24-01-63	TP-24 (x 2)
-02, -03	-EC, -EC-P, -EC-A	PT-1-24-01-60	TP-03 (x 2)
-02, -03	-EP-A, -EP-A-P	PT-1-24-02-15	TP-03 (x 2)

PROPRIETARY NOTE
 THIS DOCUMENT CONTAINS INFORMATION CONFIDENTIAL AND PROPRIETARY TO SAMTEC, INC. AND SHALL NOT BE REPRODUCED OR TRANSFERRED TO OTHER DOCUMENTS OR DISCLOSED TO OTHERS OR USED FOR ANY PURPOSE OTHER THAN THAT WHICH IT WAS OBTAINED WITHOUT THE EXPRESSED WRITTEN CONSENT OF SAMTEC, INC.

DO NOT SCALE DRAWING

SHEET SCALE: 5:1



520 PARK EAST BLVD, NEW ALBANY, IN 47150
 PHONE: 812-944-6733 FAX: 812-948-5047
 e-Mail: info@SAMTEC.com code: 55322

DESCRIPTION:
 1mm x 1mm DOUBLE VERTICAL SMT TERMINAL STRIP

DWG. NO.
FTMH-1XX-XX-XX-DV-XX

BY: PURVIS 04-22-96 SHEET 5 OF 5