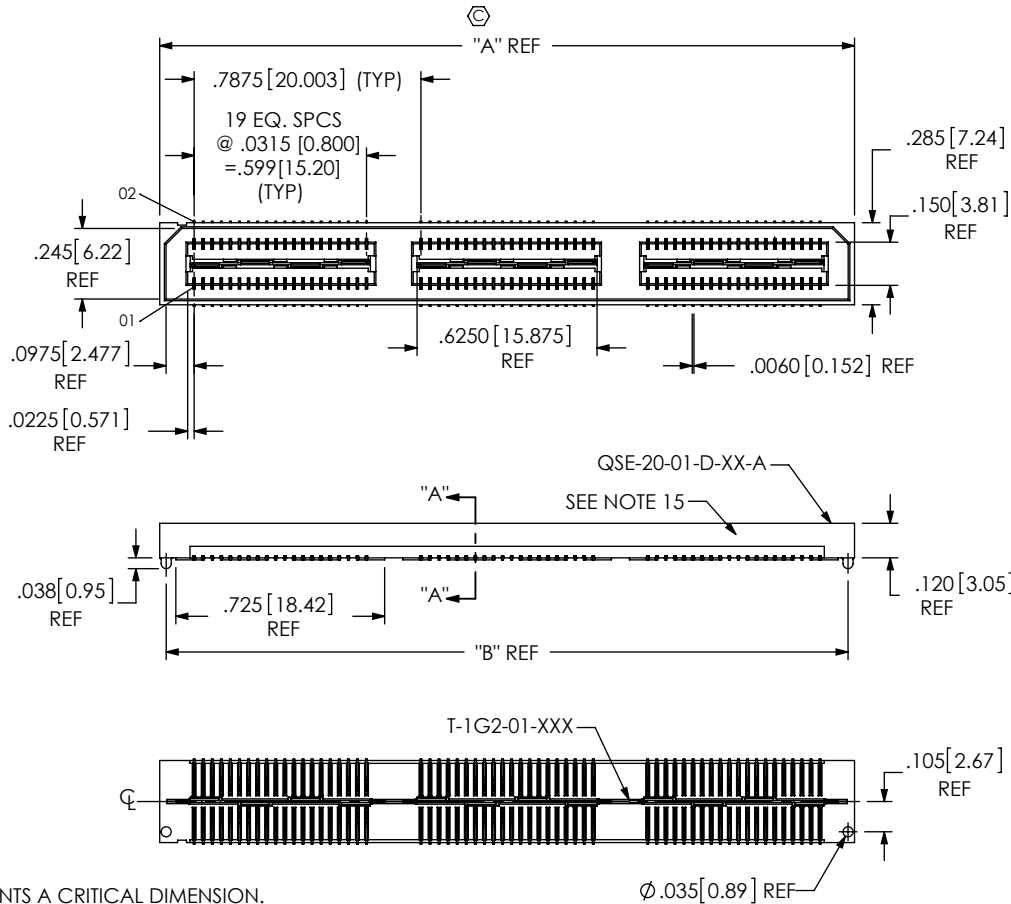

TABLE 2		
No OF POS	"A"	"B"
-020	.838 [21.27]	.793 [20.13]
-040	1.625 [41.28]	1.580 [40.13]
-060	2.413 [61.28]	2.368 [60.13]
-080	3.200 [81.28]	3.155 [80.14]
-100	3.988 [101.28]	3.943 [100.14]

TABLE 1	
No OF POS	COPLANARITY INCLUDING GP
-020 THRU -040	.004[0.10]
-060 THRU -100	.006[0.15]



QSE-XXX-01-XXX-D-XXX

No OF POSITIONS
 -020, -040, -060
 *-080, *-100 (PER ROW)
 (*= SEE NOTE 12)

LEAD STYLE
 -01: .1280[3.251]

PLATING SPECIFICATION

(SEE NOTES 8, 11 & 13)
 -F: 3μ" SELECTIVE GOLD IN CONTACT AREA, MATTE TIN ON TAIL (USE C-126-21-F, T-1G2-01-F) (SEE NOTE 8)
 -L: 10μ" SELECTIVE GOLD IN CONTACT AREA, MATTE TIN ON TAIL (USE C-126-21-L, T-1G2-01-L)
 -H: 30μ" GOLD IN CONTACT AREA, 3μ" GOLD ON TAIL (USE C-126-21-H, T-1G2-01-G)
 -C: 50μ" ELECTRO POLISHED SELECTIVE GOLD IN CONTACT AREA, MATTE TIN ON TAIL (USE C-126-21-C, T-1G2-01-L)
 -STL: 30μ" SELECTIVE GOLD IN CONTACT AREA, TIN LEAD (90/10 ±5%) ON TAIL (USE C-126-21-STL, T-1G2-01-STL)
 -FTL: 3μ" SELECTIVE GOLD IN CONTACT AREA, TIN LEAD (90/10 ±5%) ON TAIL (USE C-126-21-FTL, T-1G2-01-FTL)
 -LTL: 10μ" SELECTIVE GOLD IN CONTACT AREA, TIN LEAD (90/10 ±5%) ON TAIL (USE C-126-21-LTL, T-1G2-01-LTL)
 -S: 30μ" SELECTIVE GOLD IN CONTACT AREA, MATTE TIN ON TAIL (USE C-126-21-S, T-1G2-01-L)

OPTION

-A: ALIGNMENT PINS (USE QSE-20-XX-D-XX-A) (NOT AVAILABLE WITH -LC OPTION)
 -LC: LOCKING CLIPS (SEE NOTE 14) (USE LC-08-1M-01, SEE FIG 2, SHT 2) (NOT AVAILABLE WITH -A OPTION)
 -GP: GUIDE POSTS (SEE FIG 4, SHT 3) (USE QSE-20-01-D-XX-X-GP) (T & R PACKAGING: 40 POS MAX)
 -K: POLYIMIDE FILM (USE K-DOT-.325-.450-.005) (SEE FIG 3, SHT 2)
 -TR: TAPE & REEL (60 POS MAX) (SEE FIG 8, SHT 5) (40 POS MAX -GP OPTION)
 -FL: FRICTION LOCKS (SEE FIG 5, SHT 3) (NOT AVAILABLE WITH -GP)
 -RT1: RETENTION OPTION (MUST USE -A OPTION) (USE QSE-20-01-D-XX-A-RT1 & SUB-SC-05-01-FF) (SEE FIG 6, SHT 4) (NOT AVAILABLE WITH -LC, -GP, OR -FL) (NOT AVAILABLE WITH -100 POS)
 -L: LATCHING OPTION (40 POS MAX) (SEE FIG 7, SHT 4) (MUST USE -A OPTION) (NOT AVAILABLE WITH -LC, -GP, -FL, OR -RT1)

ROW SPECIFICATION

-D: DOUBLE (USE QSE-20-XX-D-XXX)
 No OF BANKS

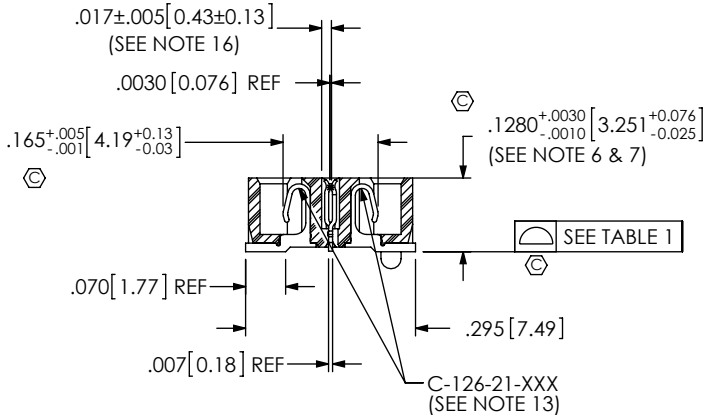

- NOTES:
1. Ⓢ REPRESENTS A CRITICAL DIMENSION.
 2. MINIMUM CONTACT RETENTION: 8 OZ
 3. MINIMUM GROUND PLANE RETENTION: 8 OZ
 4. PARTS ARE MOLDED TO POSITION.
 5. DELETED.
 6. MAXIMUM VARIANCE: .002[0.51].
 7. DIMENSION APPLIES TO CONTACTS & GROUND PLANE.
 8. -L PLATING CAN BE SUBSTITUTED FOR -F PLATING, -G PLATED GROUND PLANE CAN BE SUBSTITUTED FOR -F PLATED GROUND PLANE.
 9. GROUND PLANE PRESS HEIGHT MUST BE .003 [0.08] LESS THAN THE MAX HEIGHT OR .001 [0.03] GREATER THAN THE MINIMUM HEIGHT OF THE SOCKETS.
 10. MINIMUM SUB-SC-05-01-XX RETENTION: 1 LB IN BODY.
 11. MAY SUB C-126-01-XXX FOR C-126-21-XXX.
 12. FOR NEW APPLICATIONS REQUIRING THESE POSITIONS, PLEASE CONTACT SAMTEC INTERCONNECT PROCESSING GROUP.
 13. FOR -080, -100 POSITIONS USE C-269-11-XXX. DO NOT SUB C-126.
 14. DUE TO THE HIGH AMOUNT OF INSERTION FORCE NEEDED, THE -LC OPTION IS NOT COMPATIBLE WITH AUTO PLACEMENT. SAMTEC RECOMMENDS MANUAL PLACEMENT FOR ALL ASSEMBLIES WITH THE -LC OPTION.
 15. SIDE WALLS ARE RIBBED AS NECESSARY TO CONTROL BOW.
 16. CHECK ONCE PER BANK ALTERNATING SIDES FOR MULTIPLE BANK PARTS.

FIG 1

-A: ALIGNMENT PIN OPTION
 (QSE-060-01-XXX-D-A SHOWN)

SECTION "A"- "A"

UNLESS OTHERWISE SPECIFIED, DIMENSIONS ARE IN INCHES.
 TOLERANCES ARE:
 DECIMALS ANGLES
 .XX: ±.01[.3]
 .XXX: ±.005[.13]
 .XXXX: ±.0020[.051]

PROPRIETARY NOTE

THIS DOCUMENT CONTAINS INFORMATION CONFIDENTIAL AND PROPRIETARY TO SAMTEC, INC. AND SHALL NOT BE REPRODUCED OR TRANSFERRED TO OTHER DOCUMENTS OR DISCLOSED TO OTHERS OR USED FOR ANY PURPOSE OTHER THAN THAT WHICH IT WAS OBTAINED WITHOUT THE EXPRESSED WRITTEN CONSENT OF SAMTEC, INC.

MATERIAL: DO NOT SCALE DRAWING
 INSULATOR: LCP, UL94V-0; COLOR: BLACK
 CONTACT: PHOS BRONZE
 GROUND PLANE: PHOS BRONZE

SHEET SCALE: 1.5:1



520 PARK EAST BLVD, NEW ALBANY, IN 47150
 PHONE: 812-944-6733 FAX: 812-948-5047
 e-Mail: info@SAMTEC.com code 55322

DESCRIPTION:
 .8mm DOUBLE ROW HS SOCKET ASSEMBLY

DWG. NO.
QSE-XXX-01-XXX-D-XXX

BY: ERIC M 05/20/1999 SHEET 1 OF 5

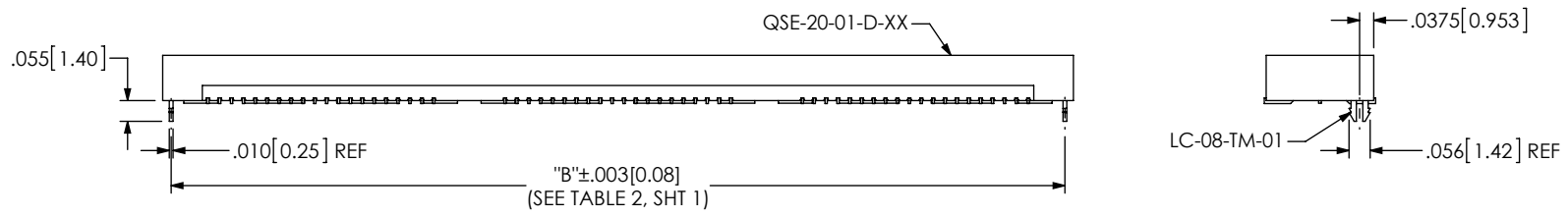

FIG 2
 -LC: LOCKING CLIP OPTION
 (QSE-060-01-XXX-D-LC SHOWN)
 (DIFFERENT AS SHOWN, OTHERWISE SAME AS FIG 1)

TABLE 3

No OF POS	"R"				"S"			
	-LC, -A, -FL	-GP	-RT1	-L	-LC, -A, -FL	-GP	-RT1	-L
-020	.839 [21.31]	1.216 [30.89]	1.438 [36.51]	1.048 [26.61]	.257 [6.53]	.446 [11.32]	.556 [14.13]	.361 [9.18]
-040	1.627 [41.31]	2.004 [50.89]	2.225 [56.52]	1.835 [46.61]	.651 [16.53]	.839 [21.32]	.950 [24.13]	.755 [19.18]
-060	2.417 [61.38]	2.791 [70.89]	3.013 [76.52]	N/A	1.046 [26.56]	1.233 [31.32]	1.344 [34.13]	N/A
-080	3.204 [81.38]	3.579 [90.89]	3.800 [96.52]	N/A	1.440 [36.56]	1.627 [41.32]	1.738 [44.13]	N/A
-100	3.991 [101.37]	4.366 [110.90]	N/A	N/A	1.833 [46.56]	2.021 [51.32]	N/A	N/A

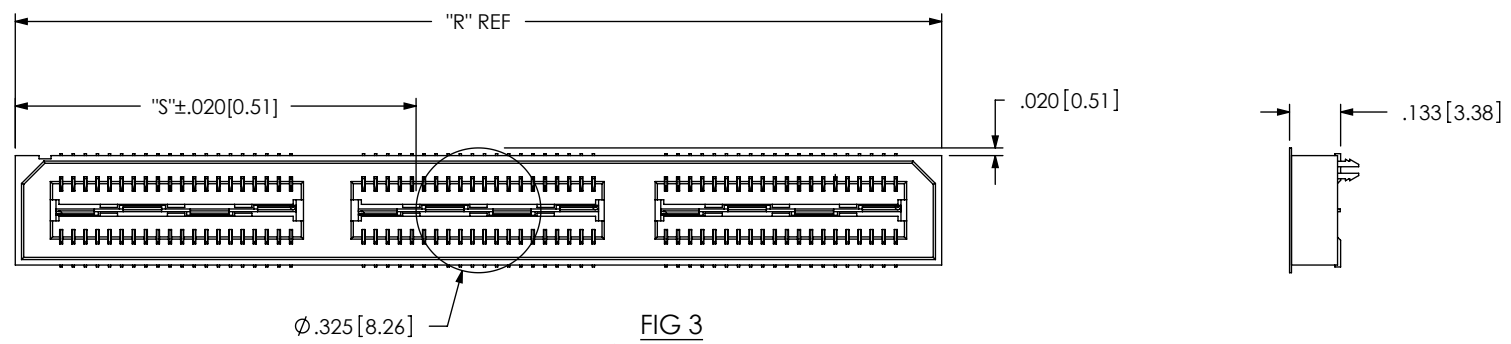



FIG 3
 -K: POLYIMIDE FILM PAD
 (K-DOT-.325-.450-.005)

F:\DWG\MISC\MKTG\QSE-XXX-01-XXX-D-XXX-MKT.SLDDRW

<p>PROPRIETARY NOTE THIS DOCUMENT CONTAINS INFORMATION CONFIDENTIAL AND PROPRIETARY TO SAMTEC, INC. AND SHALL NOT BE REPRODUCED OR TRANSFERRED TO OTHER DOCUMENTS OR DISCLOSED TO OTHERS OR USED FOR ANY PURPOSE OTHER THAN THAT WHICH IT WAS OBTAINED WITHOUT THE EXPRESSED WRITTEN CONSENT OF SAMTEC, INC.</p> <p>DO NOT SCALE DRAWING</p> <p>SHEET SCALE: 2:1</p>		
	<p>520 PARK EAST BLVD, NEW ALBANY, IN 47150 PHONE: 812-944-6733 FAX: 812-948-5047 e-Mail: info@SAMTEC.com code 55322</p>	
	<p>DESCRIPTION: .8mm DOUBLE ROW HS SOCKET ASSEMBLY</p>	
	<p>DWG. NO. QSE-XXX-01-XXX-D-XXX</p>	
<p>BY: ERIC M 05/20/1999</p>		<p>SHEET 2 OF 5</p>

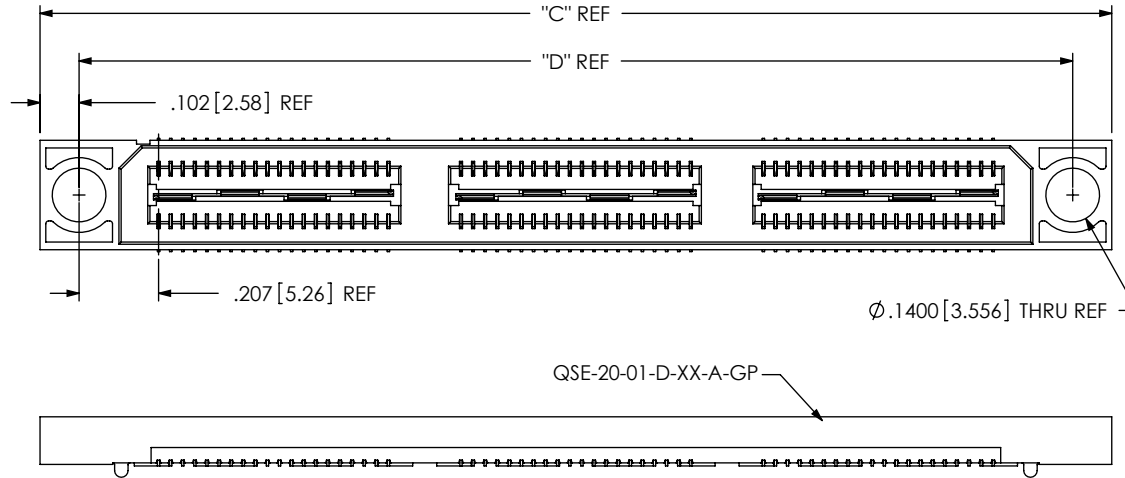
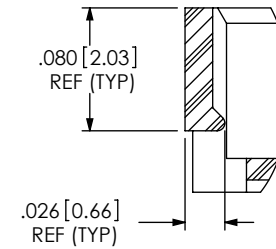
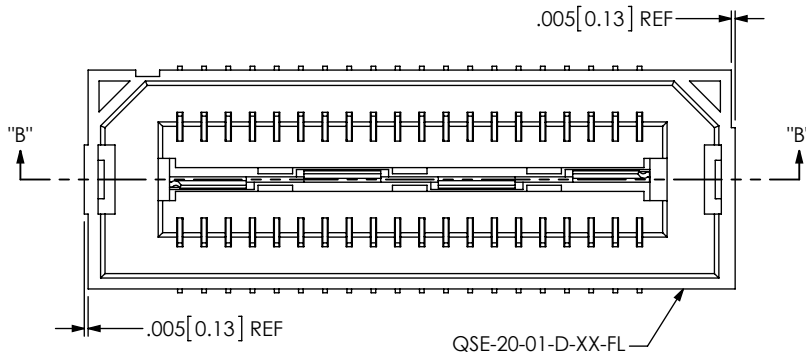

TABLE 4		
POS	"C"	"D"
-020	1.216 [30.89]	1.013 [25.72]
-040	2.004 [50.89]	1.800 [45.72]
-060	2.791 [70.89]	2.588 [65.72]
-080	3.579 [90.89]	3.375 [85.73]
-100	4.366 [110.90]	4.163 [105.73]

FIG 4
 -GP: GUIDE POST OPTION
 (QSE-060-01-XXX-D-A-GP SHOWN)
 (DIFFERENT AS SHOWN, OTHERWISE SAME AS FIG 1)
 (40 POS MAX WITH T & R PACKAGING)



DETAIL 'C'
 SCALE 8:1

FIG 5
 -FL: FRICTION LOCKS
 (QSE-020-01-XXX-D-FL SHOWN)
 (DIFFERENT AS SHOWN, OTHERWISE SAME AS FIG 1)
 (NOT AVAILABLE WITH -GP OPTION)

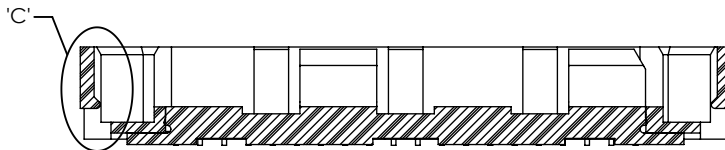

SECTION "B"-"B"
 SCALE 4:1

PROPRIETARY NOTE
 THIS DOCUMENT CONTAINS INFORMATION
 CONFIDENTIAL AND PROPRIETARY TO
 SAMTEC, INC. AND SHALL NOT BE REPRODUCED
 OR TRANSFERRED TO OTHER DOCUMENTS OR
 DISCLOSED TO OTHERS OR USED FOR ANY
 PURPOSE OTHER THAN THAT WHICH IT WAS
 OBTAINED WITHOUT THE EXPRESSED WRITTEN
 CONSENT OF SAMTEC, INC.

DO NOT SCALE DRAWING

SHEET SCALE: 2:1



520 PARK EAST BLVD, NEW ALBANY, IN 47150
 PHONE: 812-944-6733 FAX: 812-948-5047
 e-Mail info@SAMTEC.com code 55322

DESCRIPTION:
 .8mm DOUBLE ROW HS SOCKET ASSEMBLY

DWG. NO.
 QSE-XXX-01-XXX-D-XXX

BY: ERIC M 05/20/1999 SHEET 3 OF 5

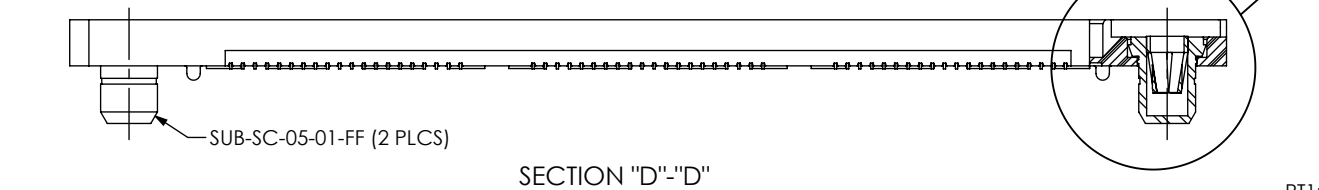
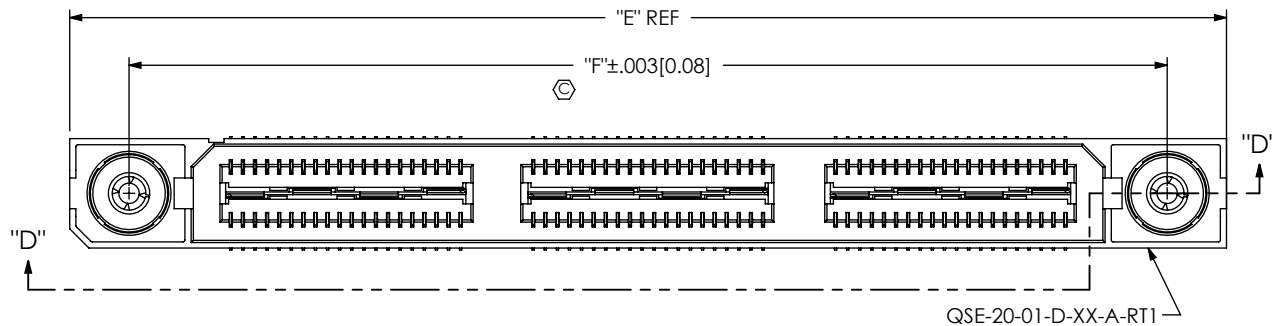

POS	"E"	"F"
-020	1.438 [36.51]	1.129 [28.66]
-040	2.225 [56.52]	1.916 [48.67]
-060	3.013 [76.52]	2.704 [68.67]
-080	3.800 [96.52]	3.491 [88.67]
-100	N/A	N/A

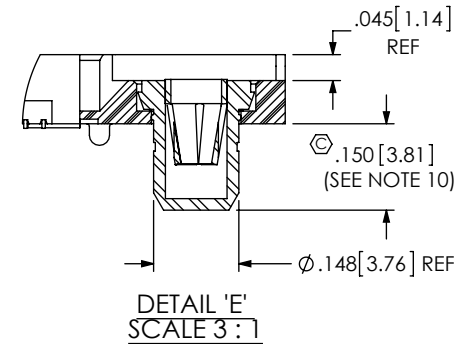
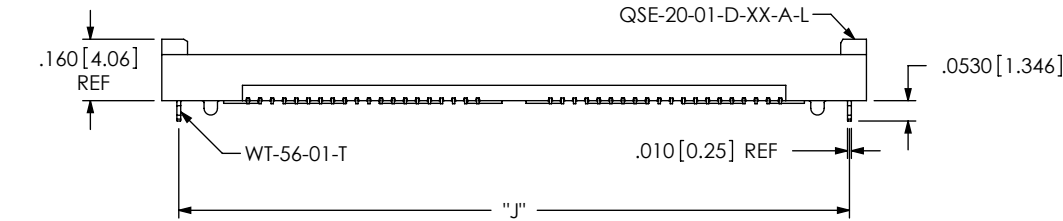
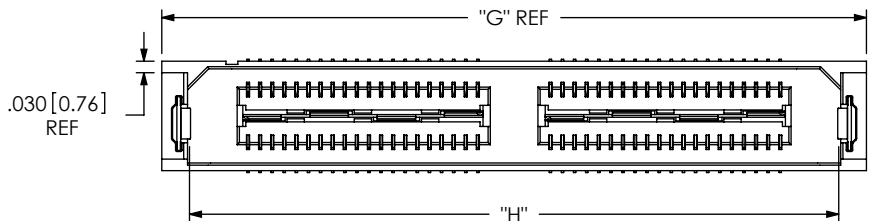

FIG 6
 -RT1: RETENTION OPTION
 (QSE-060-01-XXX-D-A-RT1 SHOWN)
 (DIFFERENT AS SHOWN, OTHERWISE SAME AS FIG 1)
 (MUST USE -A OPTION)
 (NOT AVAILABLE WITH -LC, -GP, OR -FL OPTIONS)
 (NOT AVAILABLE WITH -100 POS)



POS	"G"	"H"	"J"
-020	1.048 [26.61]	.897 [22.78]	.959 [24.36]
-040	1.835 [46.61]	1.684 [42.78]	1.747 [44.36]
-060	N/A	N/A	N/A
-080	N/A	N/A	N/A
-100	N/A	N/A	N/A

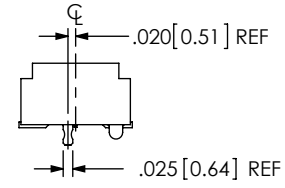

FIG 7
 -L: LATCHING OPTION
 (QSE-040-01-XXX-D-A-L SHOWN)
 (DIFFERENT AS SHOWN, OTHERWISE SAME AS FIG 1)
 (MUST USE -A OPTION) (40 POS MAX)
 (NOT AVAILABLE WITH -LC, -GP, -FL, OR -RT1 OPTIONS)

PROPRIETARY NOTE
 THIS DOCUMENT CONTAINS INFORMATION
 CONFIDENTIAL AND PROPRIETARY TO
 SAMTEC, INC. AND SHALL NOT BE REPRODUCED
 OR TRANSFERRED TO OTHER DOCUMENTS OR
 DISCLOSED TO OTHERS OR USED FOR ANY
 PURPOSE OTHER THAN THAT WHICH IT WAS
 OBTAINED WITHOUT THE EXPRESSED WRITTEN
 CONSENT OF SAMTEC, INC.

DO NOT SCALE DRAWING

SHEET SCALE: 2:1

samtec

520 PARK EAST BLVD. NEW ALBANY, IN 47150
 PHONE: 812-944-6733 FAX: 812-948-5047
 e-Mail: info@SAMTEC.com code 55322

DESCRIPTION:
 .8mm DOUBLE ROW HS SOCKET ASSEMBLY

DWG. NO.
QSE-XXX-01-XXX-D-XXX

BY: ERIC M 05/20/1999 SHEET 4 OF 5

FIG 8
 -TR: PACKAGING OPTION
 (QSE-060-01-XXX-D-LC-TR SHOWN)
 (DIFFERENT AS SHOWN, OTHERWISE SAME AS FIG 1)
 (60 POS MAX)
 (40 POS MAX WITH -GP OPTION)

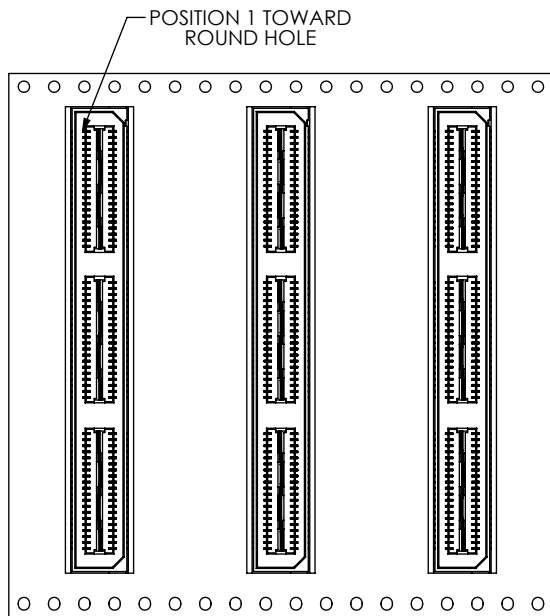

USER DIRECTION OF UNREELING →
 POCKET NOT DETAILED

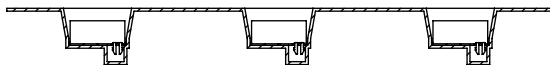

<p>PROPRIETARY NOTE THIS DOCUMENT CONTAINS INFORMATION CONFIDENTIAL AND PROPRIETARY TO SAMTEC, INC. AND SHALL NOT BE REPRODUCED OR TRANSFERRED TO OTHER DOCUMENTS OR DISCLOSED TO OTHERS OR USED FOR ANY PURPOSE OTHER THAN THAT WHICH IT WAS OBTAINED WITHOUT THE EXPRESSED WRITTEN CONSENT OF SAMTEC, INC.</p> <p>DO NOT SCALE DRAWING</p> <p>SHEET SCALE: 2:1</p>			
	<p>520 PARK EAST BLVD, NEW ALBANY, IN 47150 PHONE: 812-944-6733 FAX: 812-948-5047 e-Mail info@SAMTEC.com code 55322</p>		
	<p>DESCRIPTION: .8mm DOUBLE ROW HS SOCKET ASSEMBLY</p>		
	<p>DWG. NO. QSE-XXX-01-XXX-D-XXX</p>		
	BY: ERIC M	05/20/1999	SHEET 5 OF 5