

IEC Appliance Inlet C14 with Filter, Fuseholder 1- or 2-pole, optional Voltage Selector (step switch)

Plug removal necessary for fuse replacement



Screw-on mounting from front side
Version with earth line choke
without voltage selector
Fuse drawer must be ordered separately (see accessories).



Snap-in mounting from front side
without voltage selector
Fuse drawer must be ordered separately (see accessories).



Screw-on mounting from rear side
without voltage selector
Fuse drawer must be ordered separately (see accessories).



70° C



Description

- Panel Mount:
Screw-on version from front or rear side, snap-in version from front side
- 4 Functions:
Appliance Inlet Protection class I, Fuseholder for fuse-links 5 x 20 mm 1- or 2-pole, with or without voltage selector (step switch), Line filter in standard and medical version
- V-Lock notch standard
- Quick connect terminals or wires

Approvals

- VDE Certificate Number: 40004665 (FKE, FKF, FKV, FKW)
- UL File Number: E72928 (FKE, FKF, FKV, FKW)

Characteristics

- Rear side mounting for efficient cost-saving assembly
- Suitable for assembly in metal plated plastic housings
- All single elements are already wired
- Plug removal necessary for fuse-link replacement
The fuse drawer "Fingergrasp" can be removed by hand
For added safety "Extra-Safe" fuse drawers are available
Fuse drawer meets requirements of medical standard IEC/EN 60601-1
The fuseholder is accessible from the equipment front
- Suitable for use in equipment according to IEC/UL 60950
Suitable for use in medical equipment according to IEC/UL 60601-1

Other versions on request

- Capacity CX 100 nF

References

- Alternative: version without line filter [KEA](#)
- Alternative: Standard version

Weblinks

[pdf-datasheet](#), [html-datasheet](#), [General Product Information](#), [RoHS](#), [CHINA-RoHS](#), [REACH](#), [Mating Connectors](#), [e-Shop](#), [SCHURTER-Stock-Check](#), [Distributor-Stock-Check](#), [Accessories](#), [Wire Harnessing](#)

Technical Data

Ratings IEC	1 - 10A @ Ta 40 °C / 250 VAC; 50Hz	Appliance-Inlet/-Outlet	C14 acc. to IEC 60320,
Ratings UL/CSA	1 - 10A @ Ta 40 °C / 125 VAC; 60Hz		UL 498, CSA C22.2 no. 42 (for cold conditions) pin-temperature 70 °C, 10A, Protection Class I
Leakage Current	standard < 0.5 mA (250 V / 60 Hz) medical < 5 µA (250 V / 60 Hz)	Fuseholder	1 or 2 pole, Shocksafe category PC2 acc. to IEC 60127-6, for fuse-links 5 x 20 mm
Dielectric Strength	> 1.7 kVDC between L-N > 2.7 kVDC between L/N-PE Test voltage (2 sec)	Rated Power Acceptance @ Ta 23 °C	5 x 20: 2W (1 pole)/ 1.6W (2-pole) per pole
Allowable Operation Temp.	-25 °C to 85 °C	Power Acceptance @ Ta > 23 °C	Admissible power acceptance at higher ambient temperature see derating curves
Climatic Category	25/085/21 acc. to IEC 60068-1	Voltage Selector	optional, step, 3 pos.
Degree of Protection	from front side IP 40 acc. to IEC 60529	Line Filter	Standard and Medical Version, IEC 60939, UL 1283, CSA C22.2 no. 8 Technical Details
Protection Class	Suitable for appliances with protection class I acc. to IEC 61140	MTBF	> 1'700'000 h acc. to MIL-HB-217 F
Terminal	Quick connect terminals 6.3 x 0.8 mm Flexible wire AWG18, 150 mm		
Panel Thickness s	Screw: max 8 mm Mounting screw torque max 0.5 Nm Snap-in: 0.8 mm to 3 mm		
Material: Housing	Thermoplastic, black, UL 94V-0		

Dimension

Screw-on mounting from front side

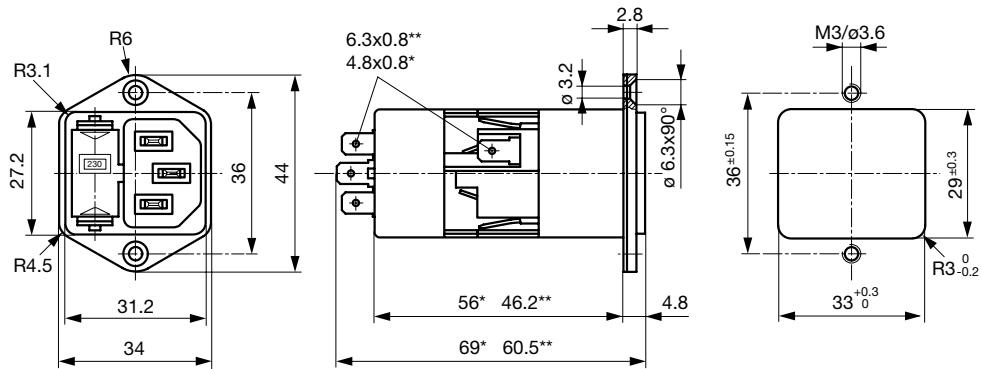

* with voltage selector

** without voltage selector

Screw-on mounting from rear side

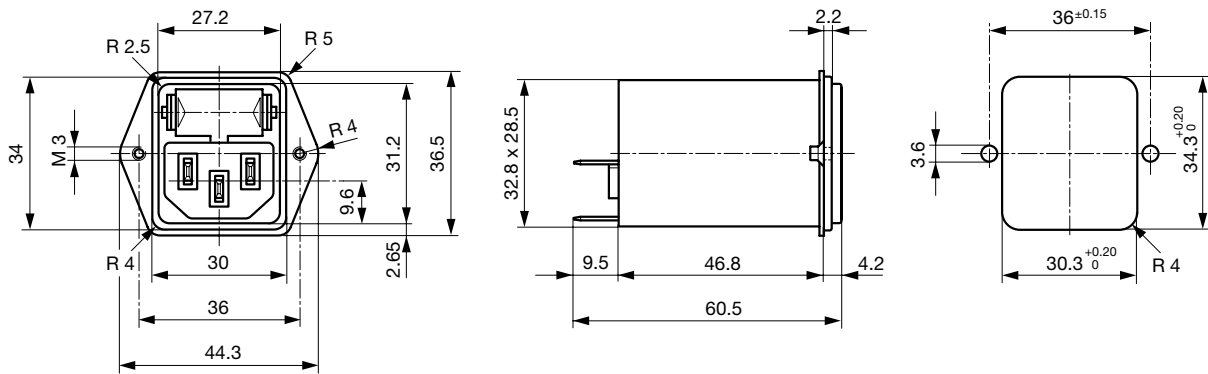

Snap-in mounting

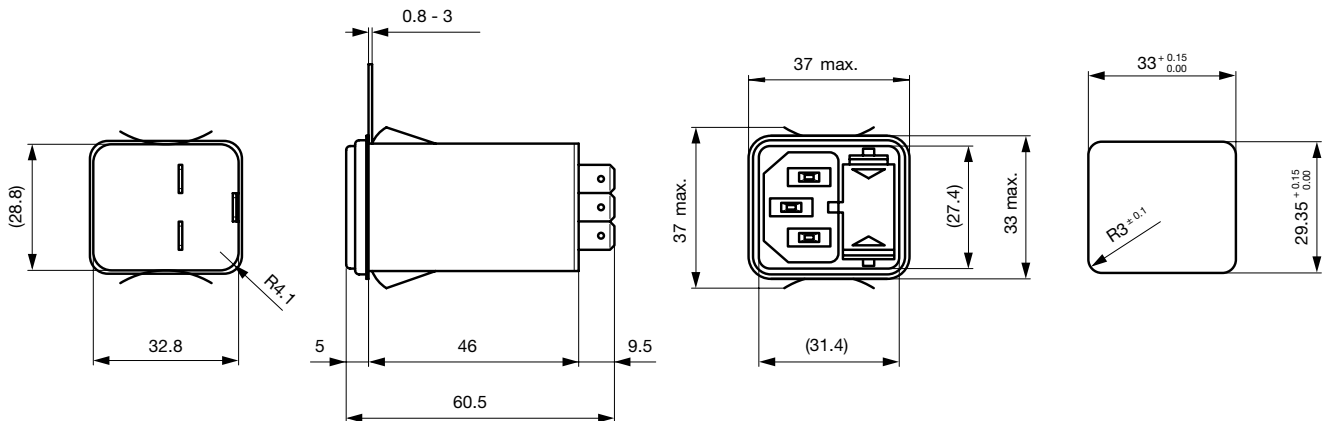

Technical Data of Filter-Components

Rated Current [A]	Filter-Type	Inductances L [mH]	Capacitance CX [nF]	Capacitance CY [nF]	R [MΩ]
1	Standard Version	2 x 10	68	2.2	-
2	Standard Version	2 x 4	68	2.2	-
4	Standard Version	2 x 1.5	68	2.2	-
6	Standard Version	2 x 0.8	68	2.2	-
10	Standard Version	2 x 0.3	68	2.2	-
1	Medical Version (M5)	2 x 10	68	-	1
2	Medical Version (M5)	2 x 4	68	-	1
4	Medical Version (M5)	2 x 1.5	68	-	1
6	Medical Version (M5)	2 x 0.8	68	-	1
10	Medical Version (M5)	2 x 0.3	68	-	1
1	Medical Version (M80)	2 x 10	68	0.47	1
2	Medical Version (M80)	2 x 4	68	0.47	1
4	Medical Version (M80)	2 x 1.5	68	0.47	1
6	Medical Version (M80)	2 x 0.8	68	0.47	1
10	Medical Version (M80)	2 x 0.3	68	0.47	1

Diagrams

Standard version
with voltage selector

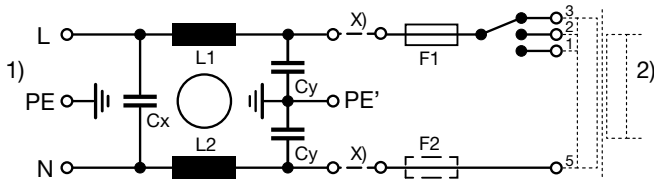

x) external connection to be made by the customer

- 1) Line
- 2) Load

Medical version (M5)
with voltage selector

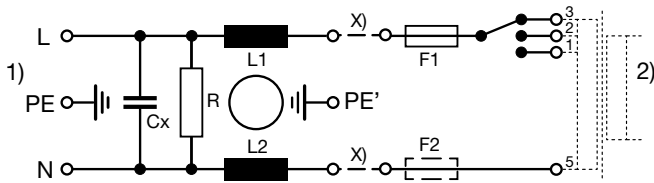

x) external connection to be made by the customer

- 1) Line
- 2) Load

Medical version (M80)
with voltage selector

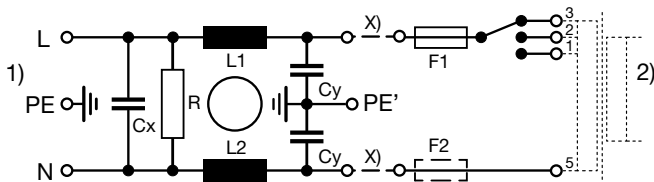

x) external connection to be made by the customer

- 1) Line
- 2) Load

Standard version
without voltage selector

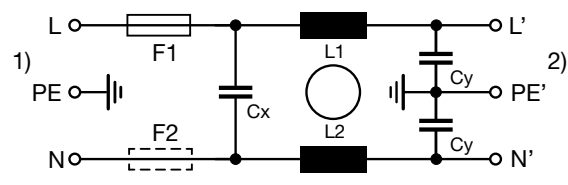

- 1) Line
- 2) Load

Medical version (M5)
without voltage selector

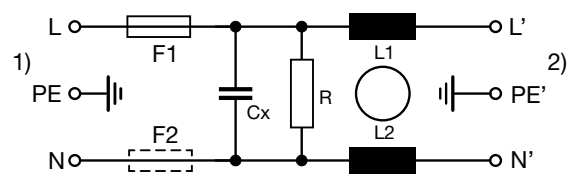

- 1) Line
- 2) Load

Medical version (M80)
without voltage selector

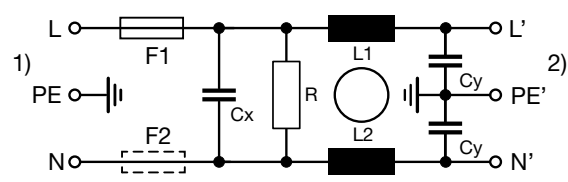

- 1) Line
- 2) Load

Derating Curves

1-pole

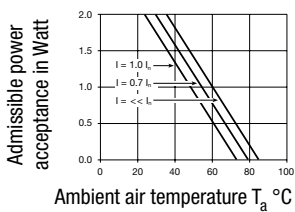

2-pole

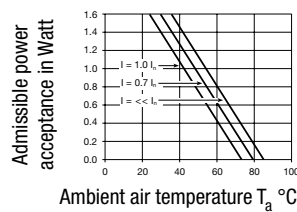

Attenuation Loss

Standard version

--- differential mode — common mode

1 A

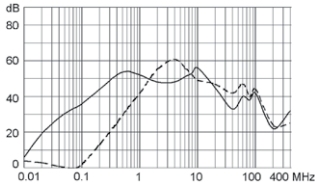

2 A

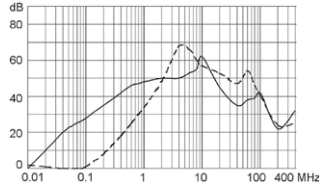

4 A

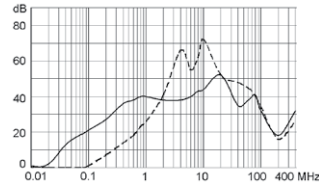

6 A

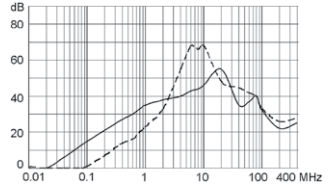

10 A

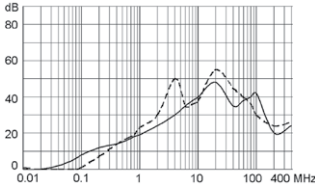

Medical version (M5)

1 A

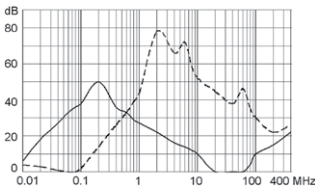

2 A

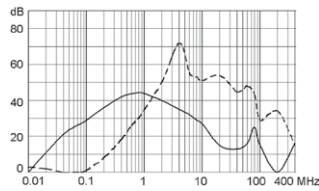

4 A

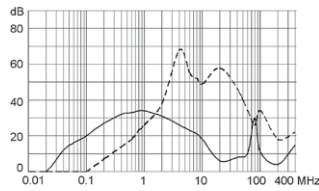

6 A

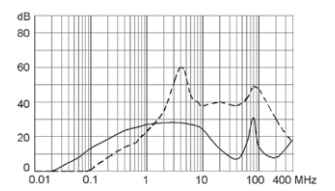

10 A

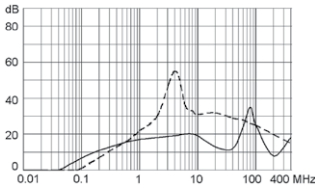

Medical version (M80)

1 A

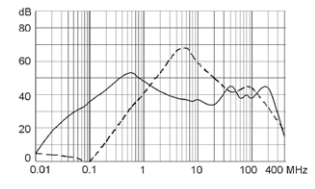

2 A

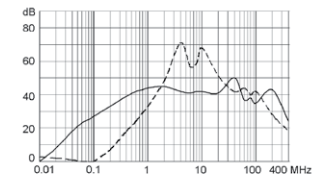

4 A

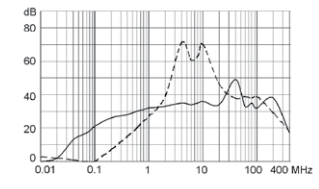

6 A

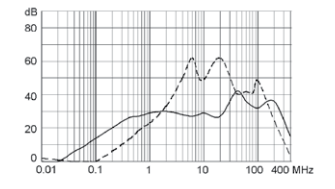

10 A

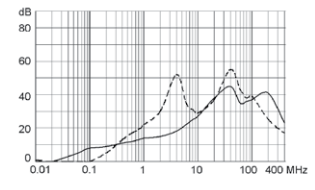

All Variants

Rated Current [A]	Filter-Type	Panel mounting	Mounting side	Fuseholder	Terminal	Voltage Selector	Order Number
1	Standard Version	Snap-in	Front Side	1-pole	Quick connect terminals 6.3 x	-	4301.6011
1	Standard Version	Snap-in	Front Side	2-pole	Quick connect terminals 6.3 x	-	4301.6001
2	Standard Version	Snap-in	Front Side	1-pole	Quick connect terminals 6.3 x	-	4301.6012
2	Standard Version	Snap-in	Front Side	2-pole	Quick connect terminals 6.3 x	-	4301.6002
4	Standard Version	Snap-in	Front Side	1-pole	Quick connect terminals 6.3 x	-	4301.6013
4	Standard Version	Snap-in	Front Side	2-pole	Quick connect terminals 6.3 x	-	4301.6003
6	Standard Version	Snap-in	Front Side	1-pole	Quick connect terminals 6.3 x	-	4301.6014
6	Standard Version	Snap-in	Front Side	2-pole	Quick connect terminals 6.3 x	-	4301.6004
10	Standard Version	Snap-in	Front Side	1-pole	Quick connect terminals 6.3 x	-	4301.6015
10	Standard Version	Snap-in	Front Side	2-pole	Quick connect terminals 6.3 x	-	4301.6005
1	Standard Version	Screw	Front Side	1-pole	Quick connect terminals 6.3 x	-	4301.5011
1	Standard Version	Screw	Front Side	1-pole	Quick connect terminals 6.3 x	3 pos.	4301.5051
1	Standard Version	Screw	Front Side	2-pole	Quick connect terminals 6.3 x	-	4301.5001
1	Standard Version	Screw	Front Side	2-pole	Quick connect terminals 6.3 x	3 pos.	4301.5041
1	Standard Version	Screw	Rear Side	1-pole	Flexible wire AWG18	-	4301.7311
1	Standard Version	Screw	Rear Side	2-pole	Flexible wire AWG18	-	4301.7301
1	Standard Version	Screw	Rear Side	2-pole	Quick connect terminals 6.3 x	-	4301.7001
2	Standard Version	Screw	Front Side	1-pole	Quick connect terminals 6.3 x	-	4301.5012
2	Standard Version	Screw	Front Side	1-pole	Quick connect terminals 6.3 x	3 pos.	4301.5052
2	Standard Version	Screw	Front Side	2-pole	Quick connect terminals 6.3 x	-	4301.5002
2	Standard Version	Screw	Front Side	2-pole	Quick connect terminals 6.3 x	3 pos.	4301.5042
2	Standard Version	Screw	Rear Side	2-pole	Quick connect terminals 6.3 x	-	4301.7002
4	Standard Version	Screw	Front Side	1-pole	Quick connect terminals 6.3 x	-	4301.5013
4	Standard Version	Screw	Front Side	1-pole	Quick connect terminals 6.3 x	3 pos.	4301.5053
4	Standard Version	Screw	Front Side	2-pole	Quick connect terminals 6.3 x	-	4301.5003
4	Standard Version	Screw	Front Side	2-pole	Quick connect terminals 6.3 x	3 pos.	4301.5043
4	Standard Version	Screw	Rear Side	1-pole	Quick connect terminals 6.3 x	-	4301.7013
4	Standard Version	Screw	Rear Side	2-pole	Quick connect terminals 6.3 x	-	4301.7003
6	Standard Version	Screw	Front Side	1-pole	Quick connect terminals 6.3 x	-	4301.5014
6	Standard Version	Screw	Front Side	1-pole	Quick connect terminals 6.3 x	3 pos.	4301.5054
6	Standard Version	Screw	Front Side	2-pole	Quick connect terminals 6.3 x	-	4301.5004
6	Standard Version	Screw	Front Side	2-pole	Quick connect terminals 6.3 x	3 pos.	4301.5044
6	Standard Version	Screw	Rear Side	1-pole	Quick connect terminals 6.3 x	-	4301.7014
6	Standard Version	Screw	Rear Side	2-pole	Quick connect terminals 6.3 x	-	4301.7004
10	Standard Version	Screw	Front Side	1-pole	Quick connect terminals 6.3 x	-	4301.5015
10	Standard Version	Screw	Front Side	1-pole	Quick connect terminals 6.3 x	3 pos.	4301.5055
10	Standard Version	Screw	Front Side	2-pole	Quick connect terminals 6.3 x	-	4301.5005
10	Standard Version	Screw	Front Side	2-pole	Quick connect terminals 6.3 x	3 pos.	4301.5045
10	Standard Version	Screw	Rear Side	1-pole	Quick connect terminals 6.3 x	-	4301.7015
10	Standard Version	Screw	Rear Side	2-pole	Quick connect terminals 6.3 x	-	4301.7005
1	Medical Version (M5)	Snap-in	Front Side	2-pole	Quick connect terminals 6.3 x	-	4301.6201
2	Medical Version (M5)	Snap-in	Front Side	2-pole	Quick connect terminals 6.3 x	-	4301.6203
4	Medical Version (M5)	Snap-in	Front Side	2-pole	Quick connect terminals 6.3 x	-	4301.6205
6	Medical Version (M5)	Snap-in	Front Side	2-pole	Quick connect terminals 6.3 x	-	4301.6207
1	Medical Version (M5)	Screw	Front Side	2-pole	Quick connect terminals 6.3 x	3 pos.	4301.5241
1	Medical Version (M5)	Screw	Rear Side	2-pole	Quick connect terminals 6.3 x	-	4301.7201
2	Medical Version (M5)	Screw	Front Side	2-pole	Quick connect terminals 6.3 x	-	4301.5203
2	Medical Version (M5)	Screw	Front Side	2-pole	Quick connect terminals 6.3 x	3 pos.	4301.5243
2	Medical Version (M5)	Screw	Rear Side	2-pole	Quick connect terminals 6.3 x	-	4301.7203
4	Medical Version (M5)	Screw	Front Side	2-pole	Quick connect terminals 6.3 x	-	4301.5205
4	Medical Version (M5)	Screw	Front Side	2-pole	Quick connect terminals 6.3 x	3 pos.	4301.5245
4	Medical Version (M5)	Screw	Rear Side	2-pole	Quick connect terminals 6.3 x	-	4301.7205
6	Medical Version (M5)	Screw	Front Side	1-pole	Quick connect terminals 6.3 x	-	4301.5217
6	Medical Version (M5)	Screw	Front Side	2-pole	Quick connect terminals 6.3 x	3 pos.	4301.5247

Rated Current [A]	Filter-Type	Panel mounting	Mounting side	Fuseholder	Terminal	Voltage Selector	Order Number
6	Medical Version (M5)	Screw	Rear Side	2-pole	Quick connect terminals 6.3 x	-	4301.7207
10	Medical Version (M5)	Screw	Front Side	2-pole	Quick connect terminals 6.3 x	-	4301.5209
10	Medical Version (M5)	Screw	Rear Side	2-pole	Quick connect terminals 6.3 x	-	4301.7209
4	Medical Version (M80)	Snap-in	Front Side	2-pole	Quick connect terminals 6.3 x	-	4301.6206
1	Medical Version (M80)	Screw	Rear Side	2-pole	Quick connect terminals 6.3 x	-	4301.7202
2	Medical Version (M80)	Screw	Front Side	2-pole	Quick connect terminals 6.3 x	-	4301.5204
2	Medical Version (M80)	Screw	Front Side	2-pole	Quick connect terminals 6.3 x	3 pos.	4301.5244
2	Medical Version (M80)	Screw	Rear Side	2-pole	Quick connect terminals 6.3 x	-	4301.7204
4	Medical Version (M80)	Screw	Front Side	2-pole	Quick connect terminals 6.3 x	-	4301.5206
4	Medical Version (M80)	Screw	Rear Side	2-pole	Quick connect terminals 6.3 x	-	4301.7206
6	Medical Version (M80)	Screw	Rear Side	2-pole	Quick connect terminals 6.3 x	-	4301.7208
10	Medical Version (M80)	Screw	Rear Side	2-pole	Quick connect terminals 6.3 x	-	4301.7200

Most Popular.

Availability for all products can be searched real-time: <http://www.schurter.com/en/Stock-Check/Stock-Check-SCHURTER>

Wire length: 150 mm

Packaging unit 10 Pcs

Required Accessory

Description



Fusedrawer 2
Fusedrawer für Fuse Links 5x20 mm, with or without Voltage Selector Insert

Accessories

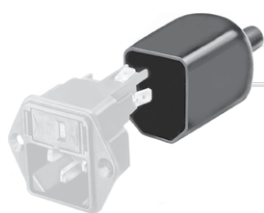

Assorted Covers
Rear Cover



Wire Harness
Wire harness for SCHURTER products



Cord retaining kits
Cord retaining strain relief

Mating Outlets/Connectors

Category / Description



[Appliance Outlet Overview complete](#)

IEC Appliance Outlet F, Screw-on Mounting, Front Side, Solder Terminal	4787
IEC Appliance Outlet F, Snap-in Mounting, Front Side, Solder or Quick-connect Terminal	4788
IEC Appliance Outlet F or H, Screw-on Mounting, Front Side, Solder, PCB or Quick-connect Terminal	5091

[Appliance Outlet further types to KFA](#)

[Connector Overview complete](#)



IEC Connector C15A, Rewireable, Straight	0102
IEC Connector C15A, Rewireable, Straight	0102-G
IEC Connector C15A, Rewireable, Angled	0112
IEC Connector C13, Rewireable, Angled	4012
IEC Connector C13, Rewireable, Straight	4022

[Connector further types to KFA](#)

Mating Outlets/Connectors shuttered



[Power Cord Overview complete](#)

Overview Power Supply Cord with IEC Connector C13, V-Lock, straight	VAC13KS
---	---------

[Power Cord further types to KFA](#)