

New Generation of WICOP

## High-Power LED – WICOP2 Z8 Y19

**SZ8-Y19-XX-XX (Cool, Neutral, Warm)**



## Product Brief

### Description

- The WICOP2 series is designed for high flux output applications with high current operation capability.
- Compact footprint(1.81x1.81mm) enables system level cost saving
- It incorporates state of the art SMD design and low thermal resistant material.
- The WICOP2 is ideal light sources for directional lighting applications such as Spot Lights, various outdoor applications, automotive lightings and high performance torches .

### Features and Benefits

- Designed for high current operation
- Low Thermal Resistance
- A wide CCT range of 2,600~7,000K
- ANSI compliant Binning
- RoHS compliant
- Phosphor film directly attached to chip surface

### Key Applications

- Residential - Replacement lamps
- Commercial/Industrial – Retail Display
- Outdoor area - Flood/Street light, High Bay

**Table 1. Product Selection Table**

Part Number	CCT			CRI
	Color	Min.	Max.	Min
SZ8-Y19-W0-C7	Cool White	4,700K	7,000K	70
SZ8-Y19-W0-C8	Cool White	4,700K	7,000K	80
SZ8-Y19-W0-C9	Cool White	4,700K	7,000K	90
SZ8-Y19-WN-C7	Neutral White	3,700K	4,700K	70
SZ8-Y19-WN-C8	Neutral White	3,700K	4,700K	80
SZ8-Y19-WN-C9	Neutral White	3,700K	4,700K	90
SZ8-Y19-WW-C7	Warm White	2,600K	3,700K	70
SZ8-Y19-WW-C8	Warm White	2,600K	3,700K	80
SZ8-Y19-WW-C9	Warm White	2,600K	3,700K	90

# Table of Contents

<b>Index</b>	
• Product Brief	1
• Table of Contents	2
• Performance Characteristics	3
• Characteristics Graph	7
• Color bin structure	12
• Mechanical Dimensions	21
• Material Structure	22
• Reflow Soldering Characteristics	23
• Emitter Tape & Reel Packaging	24
• Handling of Silicone Resin for LEDs	26
• Precaution For Use	27
• Company Information	30

## Performance Characteristics

**Table 2. Electro Optical Characteristics, I<sub>F</sub> = 350mA (CRI 70)**

Part Number	CCT [K] <sup>[1]</sup>		Min. Luminous Flux <sup>[2]</sup> Φ <sub>v</sub> <sup>[3]</sup> [lm]			Min. Luminous Flux <sup>[2]</sup> Φ <sub>v</sub> <sup>[3]</sup> [lm] @ 85 °C			CRI <sup>[4]</sup> , R <sub>a</sub>
	Min.	Max.	Group	Flux [lm] @85 °C	Flux [lm] @25 °C	700mA	1.0A	1.5A	Min.
SZ8-Y19-W0-C7	4700	7000	W5	167	184	299	394	535	70
			W4	160	175	285	376	510	
			W3	152	167	271	357	485	
			W2	142	156	254	335	455	
SZ8-Y19-WN-C7	3700	4700	W5	167	184	299	394	535	70
			W4	160	175	285	376	510	
			W3	152	167	271	357	485	
			W2	142	156	254	335	455	
SZ8-Y19-WW-C7	2600	3700	W3	152	167	271	357	485	70
			W2	142	156	254	335	455	
			W1	133	146	237	313	424	
			V3	125	137	223	294	399	

**Notes :**

(1) Correlated Color Temperature is derived from the CIE 1931 Chromaticity diagram.

Color coordinate : ±0.005, CCT ±5% tolerance.

(2) Seoul Semiconductor maintains a tolerance of ±7% on flux and power measurements.

(3) Φ<sub>v</sub> is the total luminous flux output as measured with an integrating sphere.

(4) Tolerance is ±2.0 on CRI measurements.

## Performance Characteristics

**Table 2. Electro Optical Characteristics, I<sub>F</sub> = 350mA (CRI 80)**

Part Number	CCT [K] <sup>[1]</sup>		Min. Luminous Flux <sup>[2]</sup> Φ <sub>v</sub> <sup>[3]</sup> [lm]			Min. Luminous Flux <sup>[2]</sup> Φ <sub>v</sub> <sup>[3]</sup> [lm] @ 85 °C			CRI <sup>[4]</sup> , R <sub>a</sub>
	Min.	Max.	Group	Flux [lm] @85 °C	Flux [lm] @25 °C	700mA	1.0A	1.5A	Min.
SZ8-Y19-W0-C8	4700	7000	W3	152	167	271	357	485	80
			W2	142	156	254	335	455	
			W1	133	146	237	313	424	
			V3	125	137	223	294	399	
SZ8-Y19-WN-C8	3700	4700	W3	152	167	271	357	485	80
			W2	142	156	254	335	455	
			W1	133	146	237	313	424	
			V3	125	137	223	294	399	
SZ8-Y19-WW-C8	2600	3700	W1	133	146	237	313	424	80
			V3	125	137	223	294	399	
			V2	116	128	208	274	372	
			V1	109	120	195	257	349	

**Notes :**

(1) Correlated Color Temperature is derived from the CIE 1931 Chromaticity diagram.

Color coordinate : ±0.005, CCT ±5% tolerance.

(2) Seoul Semiconductor maintains a tolerance of ±7% on flux and power measurements.

(3) Φ<sub>v</sub> is the total luminous flux output as measured with an integrating sphere.

(4) Tolerance is ±2.0 on CRI measurements.

## Performance Characteristics

**Table 2. Electro Optical Characteristics, I<sub>F</sub> = 350mA (CRI 90)**

Part Number	CCT [K] <sup>[1]</sup>		Min. Luminous Flux <sup>[2]</sup> Φ <sub>v</sub> <sup>[3]</sup> [lm]			Min. Luminous Flux <sup>[2]</sup> Φ <sub>v</sub> <sup>[3]</sup> [lm] @ 85 °C			CRI <sup>[4]</sup> , R <sub>a</sub>
	Min.	Max.	Group	Flux [lm] @85 °C	Flux [lm] @25 °C	700mA	1.0A	1.5A	Min.
SZ8-Y19-W0-C9	4700	7000	W1	133	146	237	313	424	90
			V3	125	137	223	294	399	
			V2	116	128	208	274	372	
			V1	109	120	195	257	349	
SZ8-Y19-WN-C9	3700	4700	W1	133	146	237	313	424	90
			V3	125	137	223	294	399	
			V2	116	128	208	274	372	
			V1	109	120	195	257	349	
SZ8-Y19-WW-C9	2600	3700	V2	116	128	208	274	372	90
			V1	109	120	195	257	349	
			U3	102	112	182	240	326	
			U2	96	106	172	227	308	

**Notes :**

(1) Correlated Color Temperature is derived from the CIE 1931 Chromaticity diagram.

Color coordinate : ±0.005, CCT ±5% tolerance.

(2) Seoul Semiconductor maintains a tolerance of ±7% on flux and power measurements.

(3) Φ<sub>v</sub> is the total luminous flux output as measured with an integrating sphere.

(4) Tolerance is ±2.0 on CRI measurements.

## Performance Characteristics

**Table 3. Absolute Maximum Ratings**

Parameter	Symbol	Value			Unit
		Min.	Typ.	Max.	
Forward Current <sup>[1]</sup>	$I_F$	-	-	1.5 <sup>[4]</sup> 2.0 <sup>[3]</sup>	A
Power Dissipation	$P_D$	-	-	7.8	W
Junction Temperature	$T_j$	-	-	145	°C
Operating Temperature	$T_{opr}$	- 40	-	125	°C
Storage Temperature	$T_{stg}$	- 40	-	125	°C
Viewing angle	$\theta$		140		degree
Forward voltage (350mA, 85°C)	$V_F$		2.71		V
Forward voltage (700mA, 85°C)	$V_F$		2.86		V
Thermal resistance (J to S) <sup>[2]</sup>	$R\theta_{J-S}$	-	3 <sup>[3]</sup> 4.5 <sup>[4]</sup>	-	K/W
ESD Sensitivity(HBM)		Class 2 JESD22-A114-E			

**Notes :**

- (1) At Junction Temperature 85°C condition.
  - (2)  $R\theta_{J-S}$  is tested at 700mA.
  - (3) Using Metal PCB (Dielectric layer 5W/m<sup>2</sup>K and Cu pattern of 2oz).
  - (4) Using Metal PCB (Normal type).
- Thermal resistance can be increased substantially depending on the heat sink design/operating condition, and the maximum possible driving current will decrease accordingly.

## Characteristics Graph

Fig 1. Color Spectrum

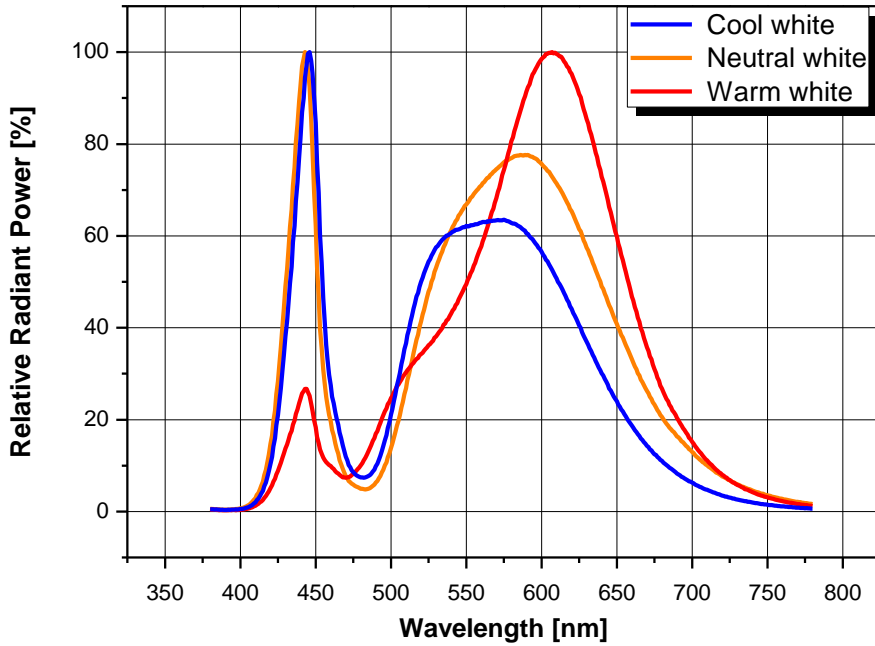
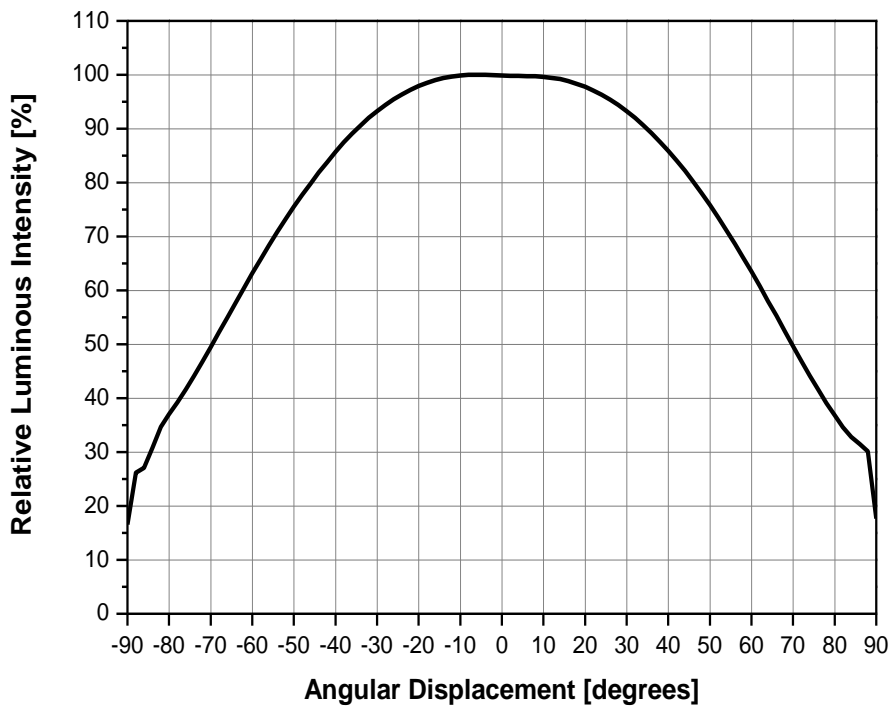

Fig 2. Typical Spatial Distribution



## Characteristics Graph

Fig 3. Forward Voltage vs. Forward Current,  $T_j=85^\circ\text{C}$

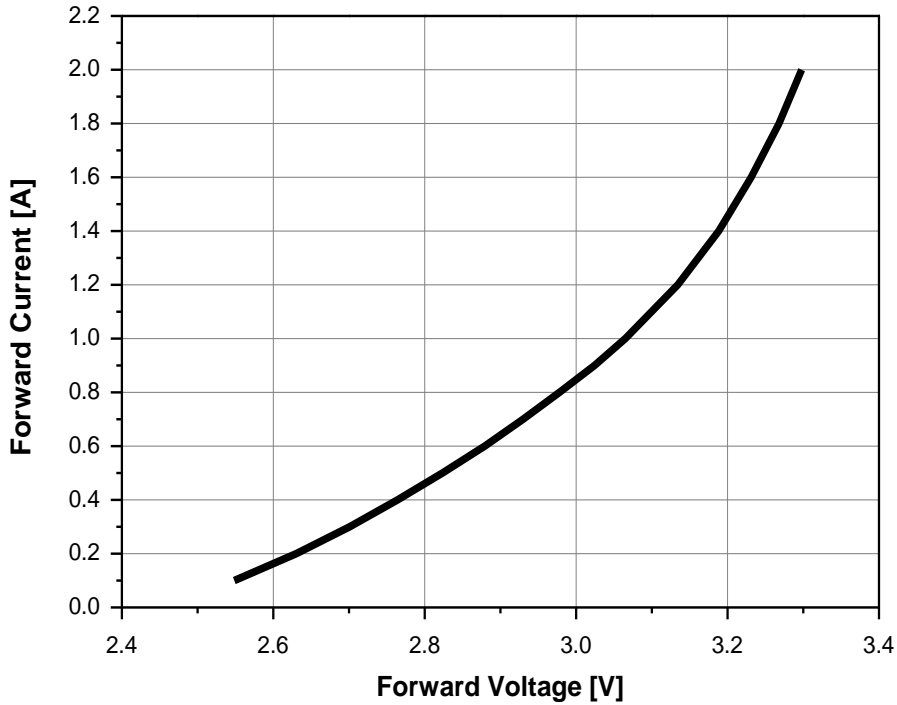
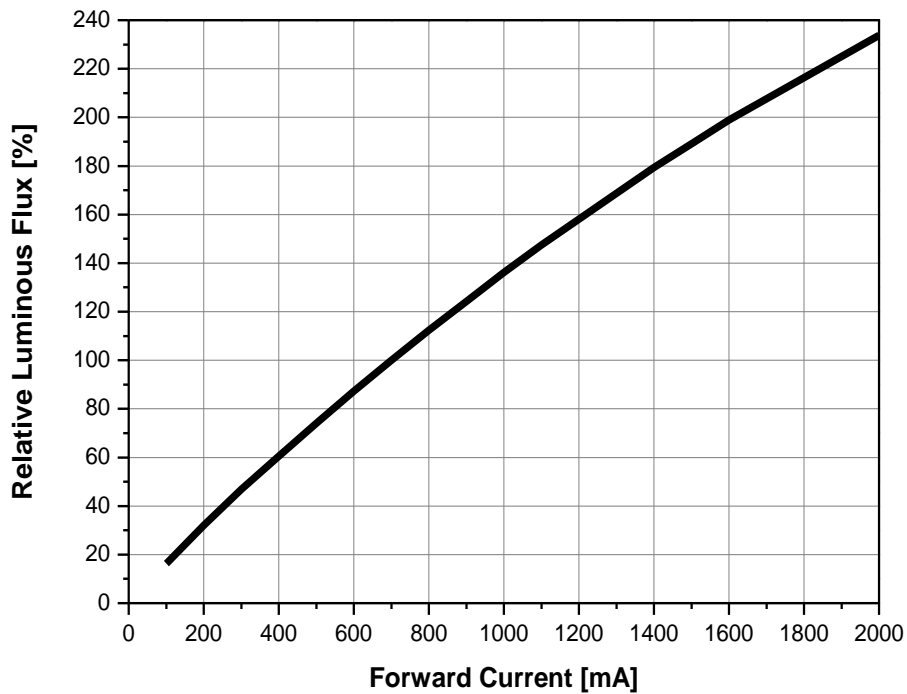
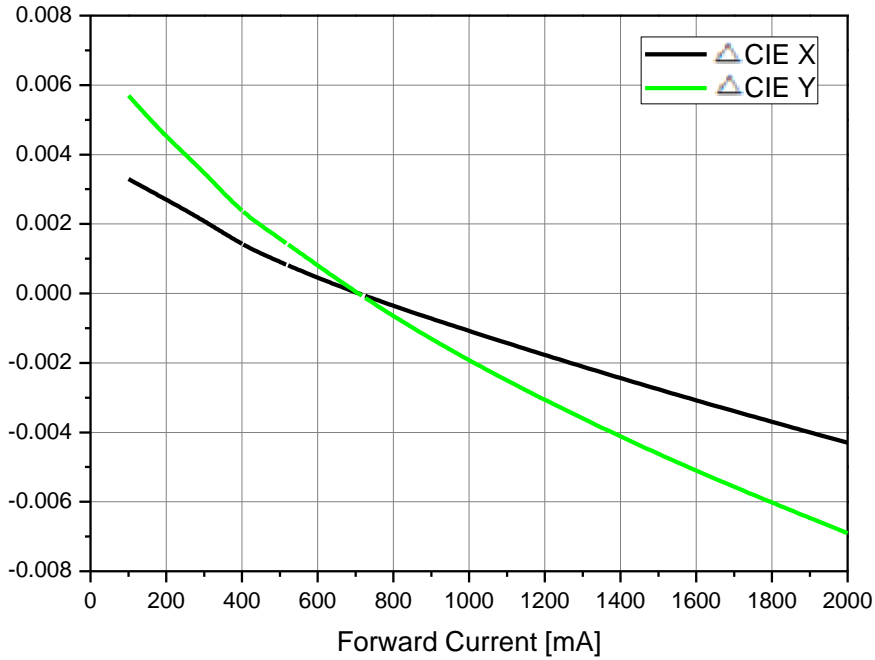
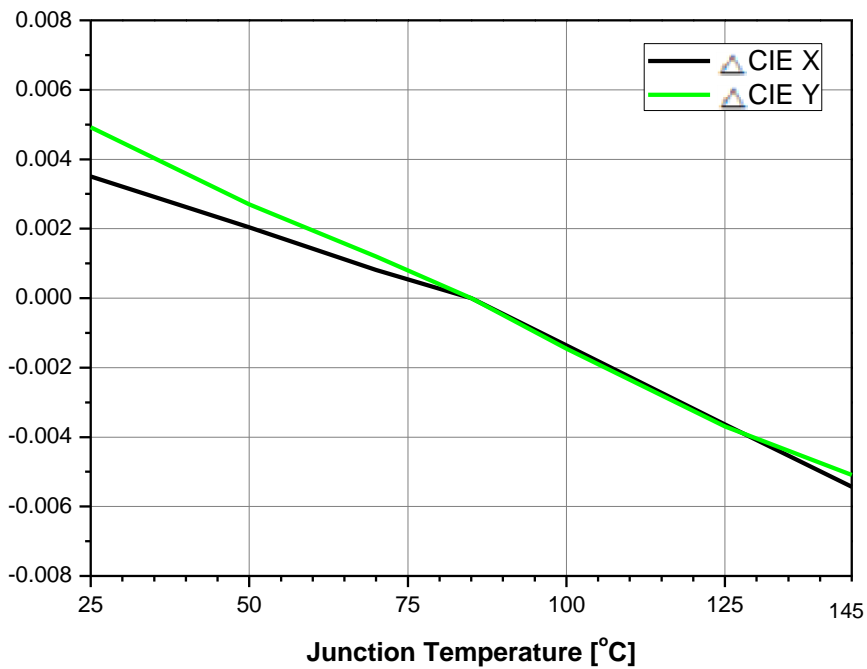

Fig 4. Forward Current vs. Relative Luminous Flux,  $T_j=85^\circ\text{C}$





## Characteristics Graph

**Fig 5. Forward Current vs. CIE X, Y Shift,  $T_j=85^\circ\text{C}$** 

**Fig 6. Junction Temp. vs. CIE X, Y Shift,  $I_F=700\text{mA}$** 

## Characteristics Graph

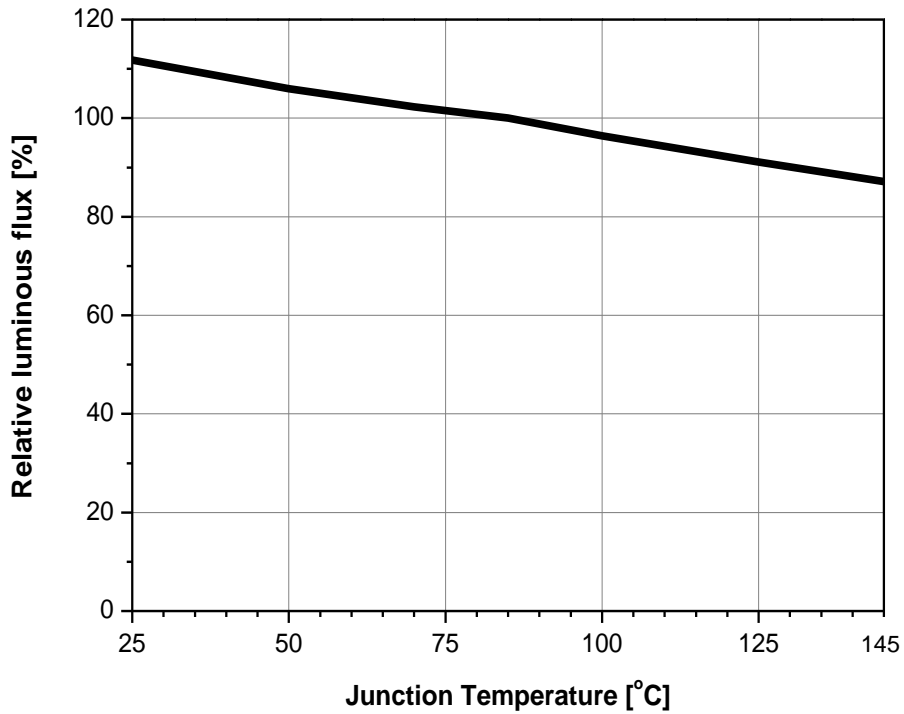
**Fig 7. Relative Light Output vs. Junction Temperature,  $I_F=700\text{mA}$**

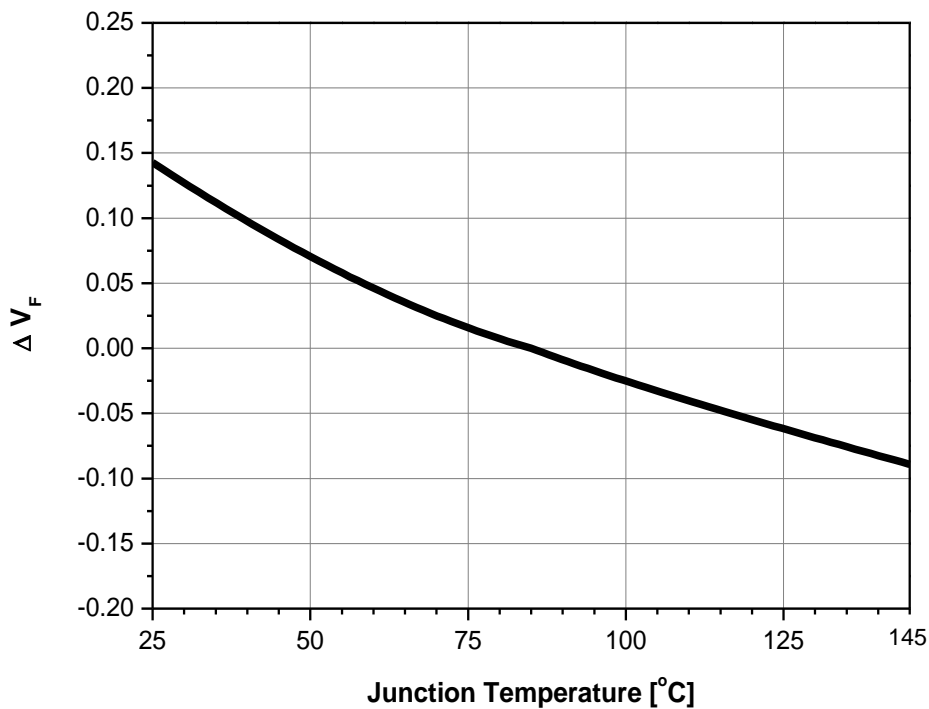
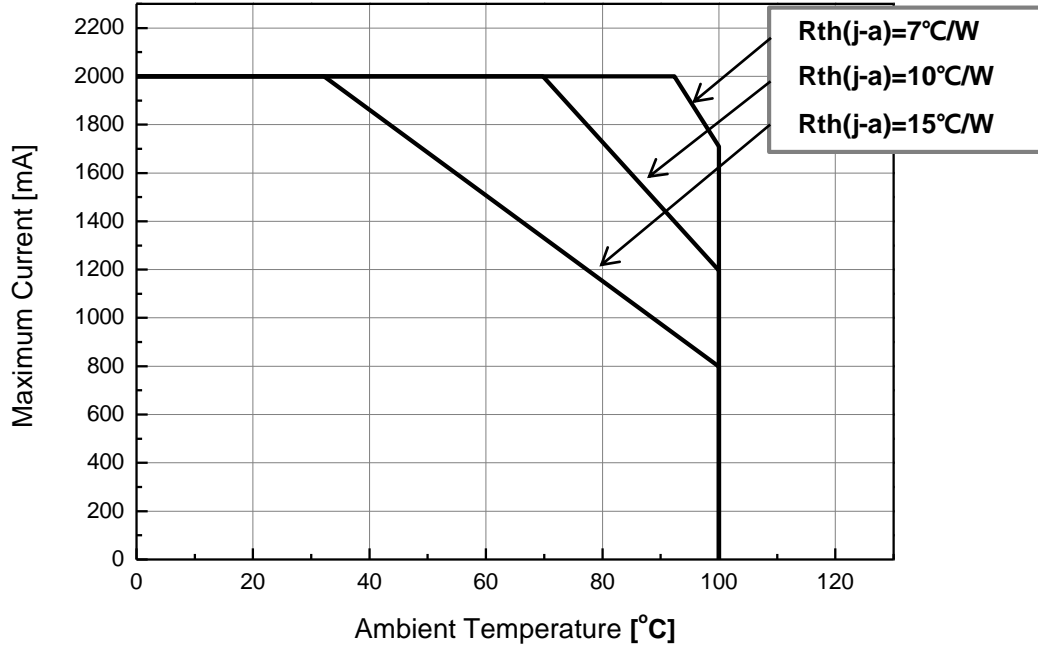

**Fig 8. Relative Forward Voltage vs. Junction Temperature,  $I_F=700\text{mA}$**



## Characteristics Graph

**Fig 9. Maximum Forward Current vs. Ambient Temperature,  $T_j(\text{max.})=145^\circ\text{C}$ ,  $I_F=2\text{A}$**



## Color Bin Structure

**Table 4. Bin Code description,  $I_F=700\text{mA}$ ,  $T_j=85^\circ\text{C}$  (CRI 70)**

Part Number	Luminous Flux [lm]			Color Chromaticity Coordinate	Typical Forward Voltage [ $V_F$ ] <sup>[1]</sup>		
	Bin Code	Min.	Max.		Bin Code	Min.	Max.
SZ8-Y19-W0-C7	W2	254	271	Refer to page. 15	G	2.75	3.00
	W3	271	285				
	W4	285	299		H	3.00	3.25
	W5	299	313				
SZ8-Y19-WN-C7	W2	254	271	Refer to page. 16~17	G	2.75	3.00
	W3	271	285				
	W4	285	299		H	3.00	3.25
	W5	299	313				
SZ8-Y19-WW-C7	V3	223	237	Refer to page. 18~20	G	2.75	3.00
	W1	237	254				
	W2	254	271		H	3.00	3.25
	W3	271	285				

**Table 5. Luminous Flux rank distribution (CRI 70)**
 Available Rank

CCT	CIE	Luminous Flux Rank						
6,000 ~ 7,000K	A	V2	V3	W1	W2	W3	W4	W5
5,300 ~ 6,000K	B	V2	V3	W1	W2	W3	W4	W5
4,700 ~ 5,300K	C	V2	V3	W1	W2	W3	W4	W5
4,200 ~ 4,700K	D	V2	V3	W1	W2	W3	W4	W5
3,700 ~ 4,200K	E	V2	V3	W1	W2	W3	W4	W5
3,200 ~ 3,700K	F	V2	V3	W1	W2	W3	W4	W5
2,900 ~ 3,200K	G	V2	V3	W1	W2	W3	W4	W5
2,600 ~ 2,900K	H	V2	V3	W1	W2	W3	W4	W5

**Notes :**

- (1) Tolerance is  $\pm 0.06\text{V}$  on forward voltage measurements.
- (2) All measurements were made under the standardized environment of Seoul Semiconductor. In order to ensure availability, single color rank will not be orderable.

## Color Bin Structure

**Table 4. Bin Code description,  $I_f=700\text{mA}$ ,  $T_j=85^\circ\text{C}$  (CRI 80)**

Part Number	Luminous Flux [lm]			Color Chromaticity Coordinate	Typical Forward Voltage [ $V_f$ ] <sup>[1]</sup>		
	Bin Code	Min.	Max.		Bin Code	Min.	Max.
SZ8-Y19-W0-C8	V3	223	237	Refer to page. 15	G	2.75	3.00
	W1	237	254				
	W2	254	271		H	3.00	3.25
	W3	271	285				
SZ8-Y19-WN-C8	V3	223	237	Refer to page. 16~17	G	2.75	3.00
	W1	237	254				
	W2	254	271		H	3.00	3.25
	W3	271	285				
SZ8-Y19-WW-C8	V1	195	208	Refer to page. 18~20	G	2.75	3.00
	V2	208	223				
	V3	223	237		H	3.00	3.25
	W1	237	254				

**Table 5. Luminous Flux rank distribution (CRI 80)**
Available Rank

CCT	CIE	Luminous Flux Rank					
6,000 ~ 7,000K	A	V1	V2	V3	W1	W2	W3
5,300 ~ 6,000K	B	V1	V2	V3	W1	W2	W3
4,700 ~ 5,300K	C	V1	V2	V3	W1	W2	W3
4,200 ~ 4,700K	D	V1	V2	V3	W1	W2	W3
3,700 ~ 4,200K	E	V1	V2	V3	W1	W2	W3
3,200 ~ 3,700K	F	V1	V2	V3	W1	W2	W3
2,900 ~ 3,200K	G	V1	V2	V3	W1	W2	W3
2,600 ~ 2,900K	H	V1	V2	V3	W1	W2	W3

**Notes :**

- (1) Tolerance is  $\pm 0.06\text{V}$  on forward voltage measurements.
- (2) All measurements were made under the standardized environment of Seoul Semiconductor. In order to ensure availability, single color rank will not be orderable.

## Color Bin Structure

**Table 4. Bin Code description,  $I_F=700\text{mA}$ ,  $T_j=85^\circ\text{C}$  (CRI 90)**

Part Number	Luminous Flux [lm]			Color Chromaticity Coordinate	Typical Forward Voltage [ $V_F$ ] <sup>[1]</sup>		
	Bin Code	Min.	Max.		Bin Code	Min.	Max.
SZ8-Y19-W0-C9	V1	195	208	Refer to page. 15	G	2.75	3.00
	V2	208	223				
	V3	223	237		H	3.00	3.25
	W1	237	254				
SZ8-Y19-WN-C9	V1	195	208	Refer to page. 16~17	G	2.75	3.00
	V2	208	223				
	V3	223	237		H	3.00	3.25
	W1	237	254				
SZ8-Y19-WW-C9	U2	172	182	Refer to page. 18~20	G	2.75	3.00
	U3	182	195				
	V1	195	208		H	3.00	3.25
	V2	208	223				

**Table 5. Luminous Flux rank distribution (CRI 90)**
 Available Rank

CCT	CIE	Luminous Flux Rank					
6,000 ~ 7,000K	A	U2	U3	V1	V2	V3	W1
5,300 ~ 6,000K	B	U2	U3	V1	V2	V3	W1
4,700 ~ 5,300K	C	U2	U3	V1	V2	V3	W1
4,200 ~ 4,700K	D	U2	U3	V1	V2	V3	W1
3,700 ~ 4,200K	E	U2	U3	V1	V2	V3	W1
3,200 ~ 3,700K	F	U2	U3	V1	V2	V3	W1
2,900 ~ 3,200K	G	U2	U3	V1	V2	V3	W1
2,600 ~ 2,900K	H	U2	U3	V1	V2	V3	W1

**Notes :**

- (1) Tolerance is  $\pm 0.06\text{V}$  on forward voltage measurements.
- (2) All measurements were made under the standardized environment of Seoul Semiconductor. In order to ensure availability, single color rank will not be orderable.

## Color Bin Structure

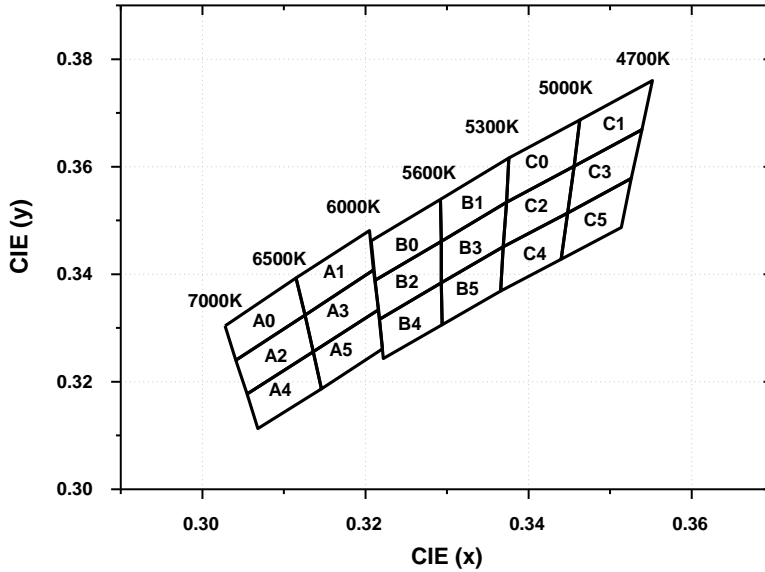
**CIE Chromaticity Diagram (Cool white),  $T_j=85^\circ\text{C}$ ,  $I_f=700\text{mA}$** 

A0		A1		A2		A3	
CIE x	CIE y	CIE x	CIE y	CIE x	CIE y	CIE x	CIE y
0.3028	0.3304	0.3115	0.3393	0.3041	0.3240	0.3126	0.3324
0.3041	0.3240	0.3126	0.3324	0.3055	0.3177	0.3136	0.3256
0.3126	0.3324	0.3210	0.3408	0.3136	0.3256	0.3216	0.3334
0.3115	0.3393	0.3205	0.3481	0.3126	0.3324	0.3210	0.3408
A4		A5		B0		B1	
CIE x	CIE y	CIE x	CIE y	CIE x	CIE y	CIE x	CIE y
0.3055	0.3177	0.3136	0.3256	0.3207	0.3462	0.3292	0.3539
0.3068	0.3113	0.3146	0.3187	0.3212	0.3389	0.3293	0.3461
0.3146	0.3187	0.3221	0.3261	0.3293	0.3461	0.3373	0.3534
0.3136	0.3256	0.3216	0.3334	0.3292	0.3539	0.3376	0.3616
B2		B3		B4		B5	
CIE x	CIE y	CIE x	CIE y	CIE x	CIE y	CIE x	CIE y
0.3212	0.3389	0.3293	0.3461	0.3217	0.3316	0.3293	0.3384
0.3217	0.3316	0.3293	0.3384	0.3222	0.3243	0.3294	0.3306
0.3293	0.3384	0.3369	0.3451	0.3294	0.3306	0.3366	0.3369
0.3293	0.3461	0.3373	0.3534	0.3293	0.3384	0.3369	0.3451
C0		C1		C2		C3	
CIE x	CIE y	CIE x	CIE y	CIE x	CIE y	CIE x	CIE y
0.3376	0.3616	0.3463	0.3687	0.3373	0.3534	0.3456	0.3601
0.3373	0.3534	0.3456	0.3601	0.3369	0.3451	0.3448	0.3514
0.3456	0.3601	0.3539	0.3669	0.3448	0.3514	0.3526	0.3578
0.3463	0.3687	0.3552	0.3760	0.3456	0.3601	0.3539	0.3669
C4		C5					
CIE x	CIE y	CIE x	CIE y				
0.3369	0.3451	0.3448	0.3514				
0.3366	0.3369	0.3440	0.3428				
0.3440	0.3428	0.3514	0.3487				
0.3448	0.3514	0.3526	0.3578				

## Color Bin Structure

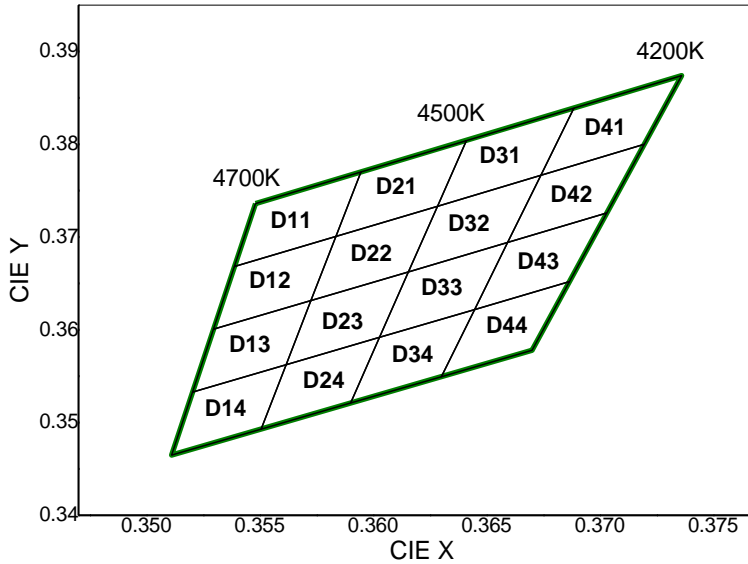
**CIE Chromaticity Diagram (Neutral White),  $T_j=85^\circ\text{C}$ ,  $I_f=700\text{mA}$** 

D11		D21		D31		D41	
CIE x	CIE y	CIE x	CIE y	CIE x	CIE y	CIE x	CIE y
0.3548	0.3736	0.3595	0.3770	0.3641	0.3804	0.3689	0.3839
0.3539	0.3668	0.3584	0.3701	0.3628	0.3733	0.3674	0.3767
0.3584	0.3701	0.3628	0.3733	0.3674	0.3767	0.3720	0.3800
0.3595	0.3770	0.3641	0.3804	0.3689	0.3839	0.3736	0.3874
D12		D22		D32		D42	
CIE x	CIE y	CIE x	CIE y	CIE x	CIE y	CIE x	CIE y
0.3539	0.3668	0.3584	0.3701	0.3628	0.3733	0.3674	0.3767
0.3530	0.3601	0.3573	0.3632	0.3616	0.3663	0.3659	0.3694
0.3573	0.3632	0.3616	0.3663	0.3659	0.3694	0.3703	0.3726
0.3584	0.3701	0.3628	0.3733	0.3674	0.3767	0.3720	0.3800
D13		D23		D33		D43	
CIE x	CIE y	CIE x	CIE y	CIE x	CIE y	CIE x	CIE y
0.3530	0.3601	0.3573	0.3632	0.3616	0.3663	0.3659	0.3694
0.3520	0.3533	0.3562	0.3562	0.3603	0.3592	0.3645	0.3622
0.3562	0.3562	0.3603	0.3592	0.3645	0.3622	0.3687	0.3652
0.3573	0.3632	0.3616	0.3663	0.3659	0.3694	0.3703	0.3726
D14		D24		D34		D44	
CIE x	CIE y	CIE x	CIE y	CIE x	CIE y	CIE x	CIE y
0.3520	0.3533	0.3562	0.3562	0.3603	0.3592	0.3645	0.3622
0.3511	0.3465	0.3551	0.3493	0.3590	0.3521	0.3630	0.3550
0.3551	0.3493	0.3590	0.3521	0.3630	0.3550	0.3670	0.3578
0.3562	0.3562	0.3603	0.3592	0.3645	0.3622	0.3687	0.3652

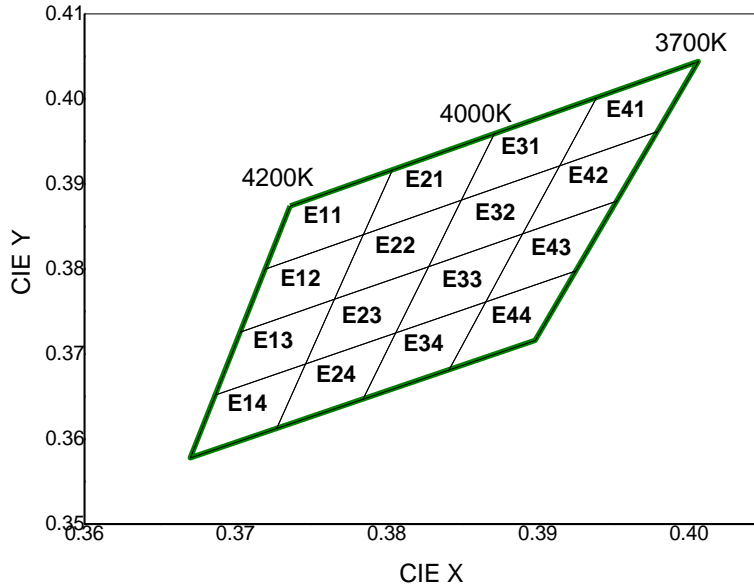

## Color Bin Structure

**CIE Chromaticity Diagram (Neutral White),  $T_j=85^\circ\text{C}$ ,  $I_f=700\text{mA}$** 

E11		E21		E31		E41	
CIE x	CIE y	CIE x	CIE y	CIE x	CIE y	CIE x	CIE y
0.3736	0.3874	0.3804	0.3917	0.3871	0.3959	0.3939	0.4002
0.3720	0.3800	0.3784	0.3841	0.3849	0.3881	0.3914	0.3922
0.3784	0.3841	0.3849	0.3881	0.3914	0.3922	0.3979	0.3962
0.3804	0.3917	0.3871	0.3959	0.3939	0.4002	0.4006	0.4044
E12		E22		E32		E42	
CIE x	CIE y	CIE x	CIE y	CIE x	CIE y	CIE x	CIE y
0.3720	0.3800	0.3784	0.3841	0.3849	0.3881	0.3914	0.3922
0.3703	0.3726	0.3765	0.3765	0.3828	0.3803	0.3890	0.3842
0.3765	0.3765	0.3828	0.3803	0.3890	0.3842	0.3952	0.3880
0.3784	0.3841	0.3849	0.3881	0.3914	0.3922	0.3979	0.3962
E13		E23		E33		E43	
CIE x	CIE y	CIE x	CIE y	CIE x	CIE y	CIE x	CIE y
0.3703	0.3726	0.3765	0.3765	0.3828	0.3803	0.3890	0.3842
0.3687	0.3652	0.3746	0.3689	0.3806	0.3725	0.3865	0.3762
0.3746	0.3689	0.3806	0.3725	0.3865	0.3762	0.3925	0.3798
0.3765	0.3765	0.3828	0.3803	0.3890	0.3842	0.3952	0.3880
E14		E24		E34		E44	
CIE x	CIE y	CIE x	CIE y	CIE x	CIE y	CIE x	CIE y
0.3687	0.3652	0.3746	0.3689	0.3806	0.3725	0.3865	0.3762
0.3670	0.3578	0.3727	0.3613	0.3784	0.3647	0.3841	0.3682
0.3727	0.3613	0.3784	0.3647	0.3841	0.3682	0.3898	0.3716
0.3746	0.3689	0.3806	0.3725	0.3865	0.3762	0.3925	0.3798

## Color Bin Structure

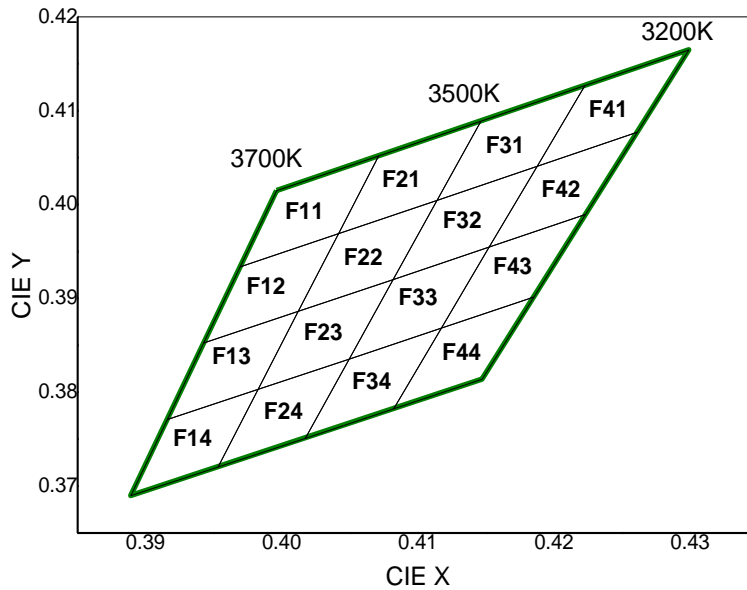
**CIE Chromaticity Diagram (Warm White),  $T_j=85^\circ\text{C}$ ,  $I_f=700\text{mA}$** 

F11		F21		F31		F41	
CIE x	CIE y	CIE x	CIE y	CIE x	CIE y	CIE x	CIE y
0.3996	0.4015	0.4071	0.4052	0.4146	0.4089	0.4223	0.4127
0.3969	0.3934	0.4042	0.3969	0.4114	0.4005	0.4187	0.4041
0.4042	0.3969	0.4114	0.4005	0.4187	0.4041	0.4261	0.4077
0.4071	0.4052	0.4146	0.4089	0.4223	0.4127	0.4299	0.4165
F12		F22		F32		F42	
CIE x	CIE y	CIE x	CIE y	CIE x	CIE y	CIE x	CIE y
0.3969	0.3934	0.4042	0.3969	0.4114	0.4005	0.4187	0.4041
0.3943	0.3853	0.4012	0.3886	0.4082	0.3920	0.4152	0.3955
0.4012	0.3886	0.4082	0.3920	0.4152	0.3955	0.4223	0.3990
0.4042	0.3969	0.4114	0.4005	0.4187	0.4041	0.4261	0.4077
F13		F23		F33		F43	
CIE x	CIE y	CIE x	CIE y	CIE x	CIE y	CIE x	CIE y
0.3943	0.3853	0.4012	0.3886	0.4082	0.3920	0.4152	0.3955
0.3916	0.3771	0.3983	0.3803	0.4049	0.3836	0.4117	0.3869
0.3983	0.3803	0.4049	0.3836	0.4117	0.3869	0.4185	0.3902
0.4012	0.3886	0.4082	0.3920	0.4152	0.3955	0.4223	0.3990
F14		F24		F34		F44	
CIE x	CIE y	CIE x	CIE y	CIE x	CIE y	CIE x	CIE y
0.3916	0.3771	0.3983	0.3803	0.4049	0.3836	0.4117	0.3869
0.3889	0.3690	0.3953	0.3721	0.4017	0.3751	0.4082	0.3783
0.3953	0.3721	0.4017	0.3751	0.4082	0.3783	0.4147	0.3814
0.3983	0.3803	0.4049	0.3836	0.4117	0.3869	0.4185	0.3902

## Color Bin Structure

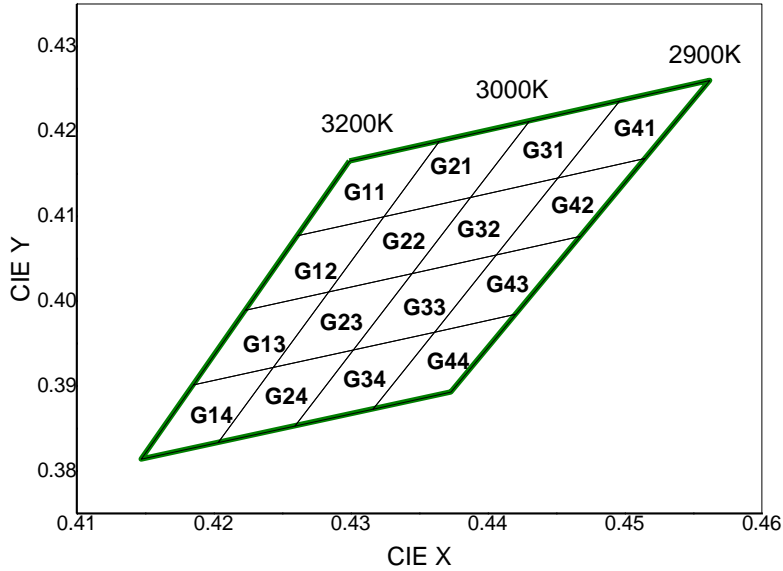
**CIE Chromaticity Diagram (Warm White),  $T_j=85^\circ\text{C}$ ,  $I_f=700\text{mA}$** 

G11		G21		G31		G41	
CIE x	CIE y	CIE x	CIE y	CIE x	CIE y	CIE x	CIE y
0.4299	0.4165	0.4364	0.4188	0.4430	0.4212	0.4496	0.4236
0.4261	0.4077	0.4324	0.4099	0.4387	0.4122	0.4451	0.4145
0.4324	0.4100	0.4387	0.4122	0.4451	0.4145	0.4514	0.4168
0.4365	0.4189	0.4430	0.4212	0.4496	0.4236	0.4562	0.4260
G12		G22		G32		G42	
CIE x	CIE y	CIE x	CIE y	CIE x	CIE y	CIE x	CIE y
0.4261	0.4077	0.4324	0.4100	0.4387	0.4122	0.4451	0.4145
0.4223	0.3990	0.4284	0.4011	0.4345	0.4033	0.4406	0.4055
0.4284	0.4011	0.4345	0.4033	0.4406	0.4055	0.4468	0.4077
0.4324	0.4100	0.4387	0.4122	0.4451	0.4145	0.4515	0.4168
G13		G23		G33		G43	
CIE x	CIE y	CIE x	CIE y	CIE x	CIE y	CIE x	CIE y
0.4223	0.3990	0.4284	0.4011	0.4345	0.4033	0.4406	0.4055
0.4185	0.3902	0.4243	0.3922	0.4302	0.3943	0.4361	0.3964
0.4243	0.3922	0.4302	0.3943	0.4361	0.3964	0.4420	0.3985
0.4284	0.4011	0.4345	0.4033	0.4406	0.4055	0.4468	0.4077
G14		G24		G34		G44	
CIE x	CIE y	CIE x	CIE y	CIE x	CIE y	CIE x	CIE y
0.4243	0.3922	0.4302	0.3943	0.4302	0.3943	0.4361	0.3964
0.4203	0.3834	0.4259	0.3853	0.4259	0.3853	0.4316	0.3873
0.4147	0.3814	0.4203	0.3834	0.4316	0.3873	0.4373	0.3893
0.4185	0.3902	0.4243	0.3922	0.4361	0.3964	0.4420	0.3985

## Color Bin Structure

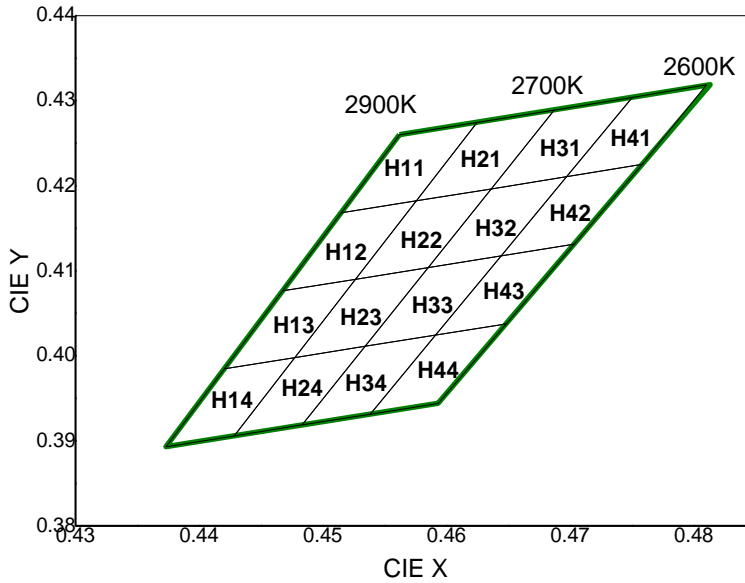
**CIE Chromaticity Diagram (Warm White),  $T_j=85^\circ\text{C}$ ,  $I_f=700\text{mA}$** 

H11		H21		H31		H41	
CIE x	CIE y	CIE x	CIE y	CIE x	CIE y	CIE x	CIE y
0.4562	0.4260	0.4625	0.4275	0.4687	0.4289	0.4750	0.4304
0.4515	0.4168	0.4575	0.4182	0.4636	0.4197	0.4697	0.4211
0.4575	0.4182	0.4636	0.4197	0.4697	0.4211	0.4758	0.4225
0.4625	0.4275	0.4687	0.4289	0.4750	0.4304	0.4810	0.4319
H12		H22		H32		H42	
CIE x	CIE y	CIE x	CIE y	CIE x	CIE y	CIE x	CIE y
0.4515	0.4168	0.4575	0.4182	0.4636	0.4197	0.4697	0.4211
0.4468	0.4077	0.4526	0.4090	0.4585	0.4104	0.4644	0.4118
0.4526	0.4090	0.4585	0.4104	0.4644	0.4118	0.4703	0.4132
0.4575	0.4182	0.4636	0.4197	0.4697	0.4211	0.4758	0.4225
H13		H23		H33		H43	
CIE x	CIE y	CIE x	CIE y	CIE x	CIE y	CIE x	CIE y
0.4468	0.4077	0.4526	0.4090	0.4585	0.4104	0.4644	0.4118
0.4420	0.3985	0.4477	0.3998	0.4534	0.4012	0.4591	0.4025
0.4477	0.3998	0.4534	0.4012	0.4591	0.4025	0.4648	0.4038
0.4526	0.4090	0.4585	0.4104	0.4644	0.4118	0.4703	0.4132
H14		H24		H34		H44	
CIE x	CIE y	CIE x	CIE y	CIE x	CIE y	CIE x	CIE y
0.4420	0.3985	0.4477	0.3998	0.4534	0.4012	0.4591	0.4025
0.4373	0.3893	0.4428	0.3906	0.4483	0.3919	0.4538	0.3932
0.4428	0.3906	0.4483	0.3919	0.4538	0.3932	0.4593	0.3944
0.4477	0.3998	0.4534	0.4012	0.4591	0.4025	0.4648	0.4038

## Mechanical Dimensions

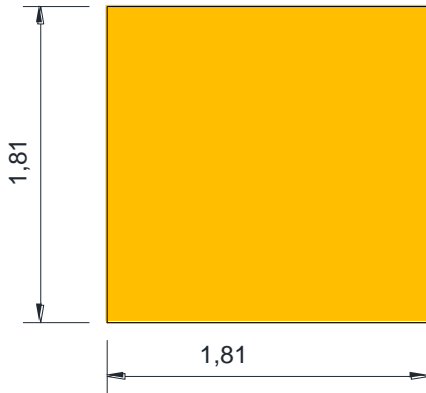

< Top >

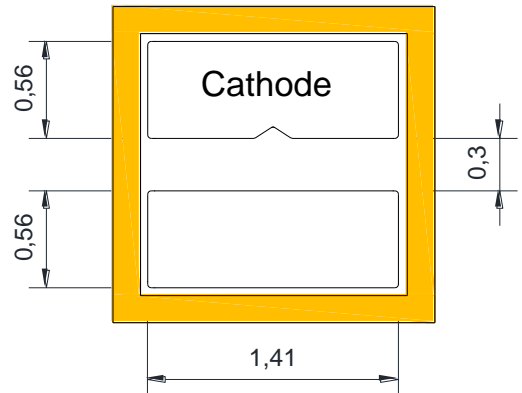

< Bottom >

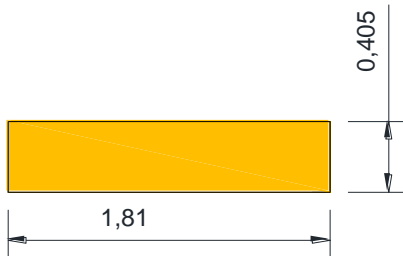

< Side >

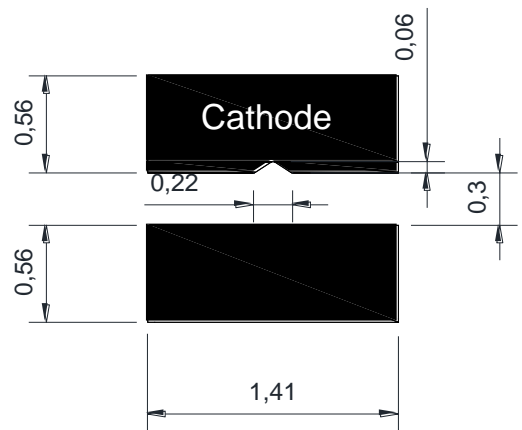

< Recommended Solder Pattern >

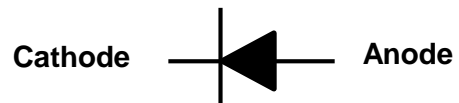

< Inner circuit >

- (1) All dimensions are in millimeters.
- (2) Scale : none
- (3) Undefined tolerance is  $\pm 0.2\text{mm}$

## Material Structure

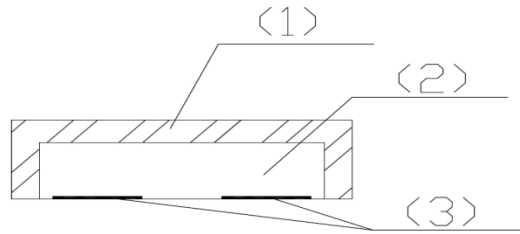

No.	List	Material
①	Encapsulation	Silicone, Phosphor
②	Chip Source	GaN ON SAPPHIRE
③	Solder-PAD	Metal (Au)

## Reflow Soldering Characteristics

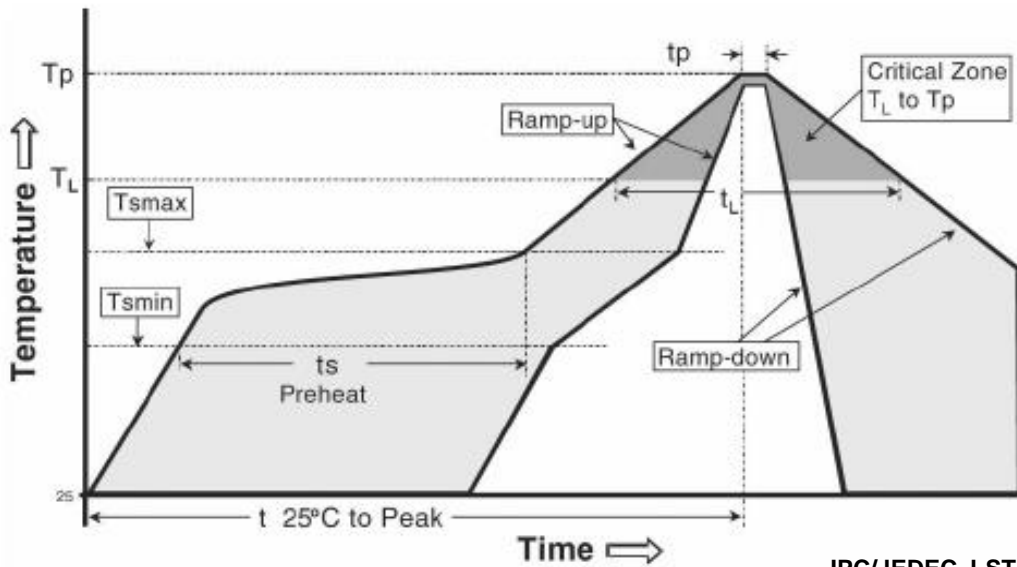
**IPC/JEDEC J-STD-020**

Profile Feature	Pb-Free Assembly
Average ramp-up rate (T <sub>smax</sub> to T <sub>p</sub> )	3° C/second max.
Preheat - Temperature Min (T <sub>smin</sub> ) - Temperature Max (T <sub>smax</sub> ) - Time (T <sub>smin</sub> to T <sub>smax</sub> ) (t <sub>s</sub> )	150 °C 180 °C 80-120 seconds
Time maintained above: - Temperature (T <sub>L</sub> ) - Time (t <sub>L</sub> )	217~220°C 80-100 seconds
Peak Temperature (T <sub>p</sub> )	250~255°C
Time within 5°C of actual Peak Temperature (t <sub>p</sub> ) <sub>2</sub>	20-40 seconds
Ramp-down Rate	6 °C/second max.
Time 25°C to Peak Temperature	8 minutes max.
Atmosphere	Nitrogen (O <sub>2</sub> <1000ppm)

### Caution

- (1) Reflow soldering is recommended not to be done more than two times. In the case of more than 24 hours passed soldering after first, LEDs will be damaged.
- (2) Re-soldering should not be done after the LEDs have been soldered. If re-soldering is unavoidable, LED's characteristics should be carefully checked before and after such repair..
- (3) Do not put stress on the LEDs during heating.
- (4) After reflow, do not clean PCB by water or solvent.

### SMT recommendation

- (1) After reflow, Over 80% reflectance of PSR is recommended. → Tamura RPW-8000-xx
- (2) Solder paste materials (SAC 305, No Cleaning Paste ) → Senju M705-GRN360-KV
- (3) We recommend TOV Test 1.8v~2.8v at 1uA (per LED)
- (4) We recommend IR Test 0~1uA at -5V (per LED)

## Emitter Tape & Reel Packaging

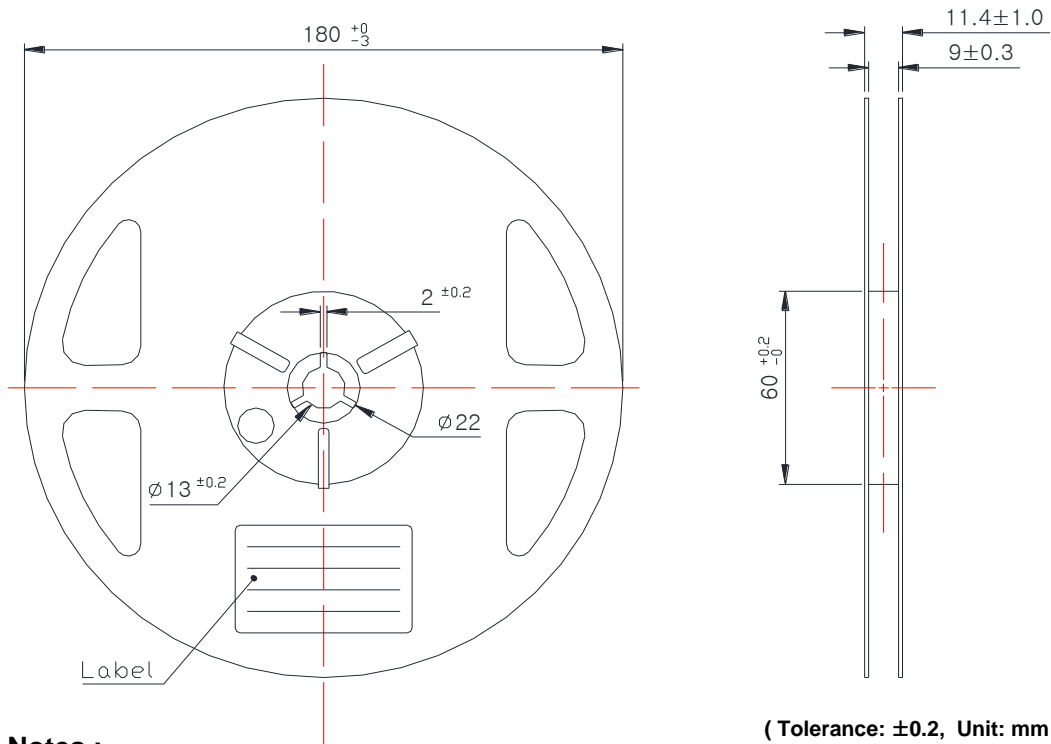
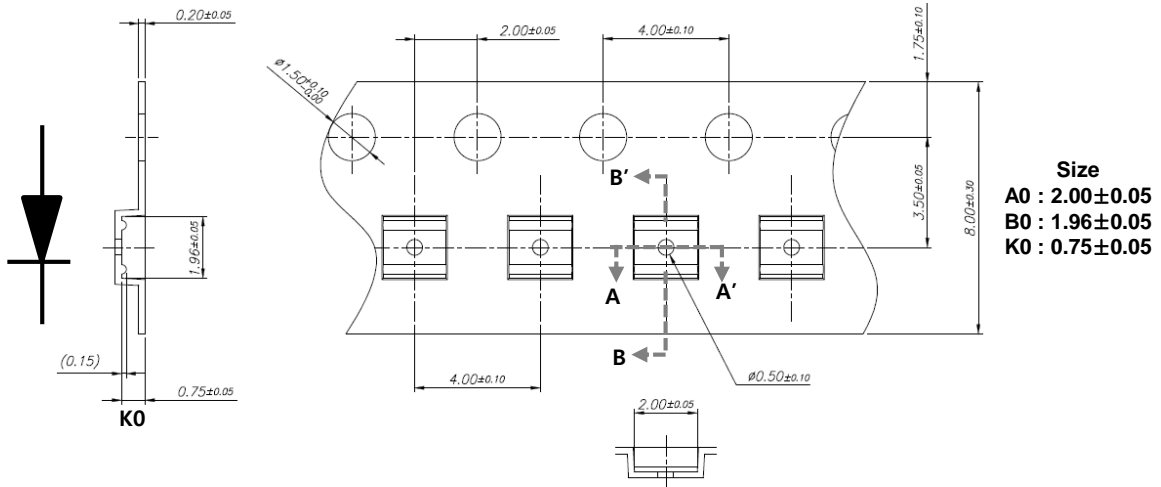
**Notes :**

- (1) Quantity : 1,500pcs/Reel  
(empty slot possible in taping reel)
- (2) Cumulative Tolerance : Cumulative Tolerance/10 pitches to be ±0.2mm
- (3) Adhesion Strength of Cover Tape : Adhesion strength to be 0.1-0.7N when the cover tape is turned off from the carrier tape at the angle of 10° to the carrier tape
- (4) Package : P/N, Manufacturing data Code No. and quantity to be indicated on a damp proof Package



## Packaging Information

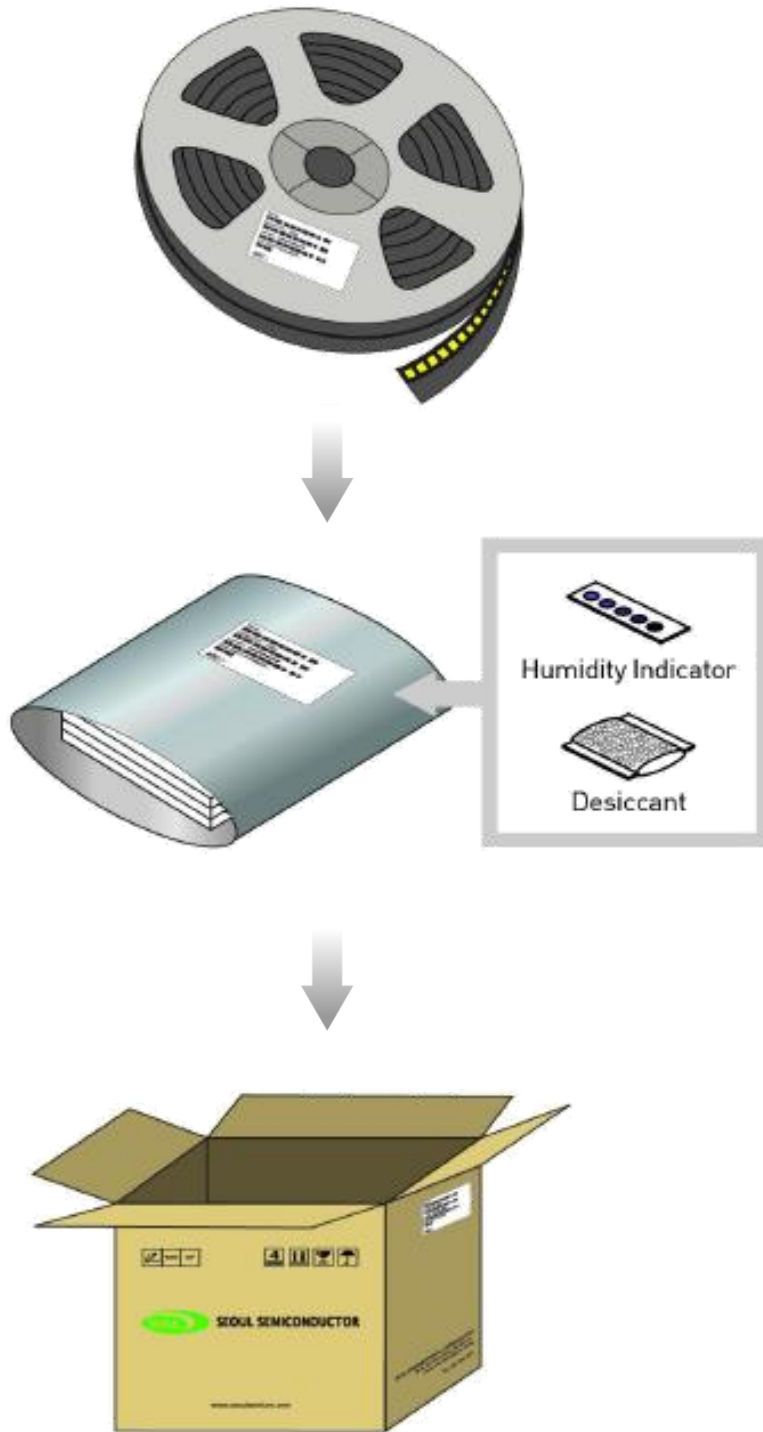

## Handling of Silicone Resin for LEDs

- (1) During processing, mechanical stress on the surface should be minimized as much as possible. Sharp objects of all types should not be used to pierce the sealing compound.



- (2) Do not use tweezers to pick up or handle WICOP2 LEDs. A vacuum pick up should only be used.
- (3) When populating boards in SMT production, there are basically no restrictions regarding the form of the pick and place nozzle, except that mechanical pressure on the surface of the resin must be prevented. This is assured by choosing a pick and place nozzle which is smaller than the LED's area.
- (4) Silicone differs from materials conventionally used for the manufacturing of LEDs. These conditions must be considered during the handling of such devices. Compared to standard encapsulants, silicone is generally softer, and the surface is more likely to attract dust. As mentioned previously, the increased sensitivity to dust requires special care during processing.
- (5) Please do not mold this product into another resin (epoxy, urethane, etc) and do not handle this product with acid or sulfur material in sealed space.
- (6) Avoid leaving fingerprints on silicone resin parts.

## Precaution for Use

### (1) Storage

To avoid the moisture penetration, we recommend storing LEDs in a dry box with a desiccant . The recommended storage temperature range is 5°C to 30°C and a maximum humidity of RH50%.

### (2) Use Precaution after Opening the Packaging

Use proper SMD techniques when the LED is to be soldered dipped as separation of the lens may affect the light output efficiency.

Pay attention to the following:

#### a. Recommend conditions after opening the package

- Sealing / Temperature : 5 ~ 30°C Humidity : less than RH60%

#### b. If the package has been opened more than 1 year (MSL 2) or the color of

the desiccant changes, components should be dried for 10-24hr at 65±5°C

(3) Do not apply mechanical force or excess vibration during the cooling process to normal temperature after soldering.

(4) Do not rapidly cool device after soldering.

(5) Components should not be mounted on warped (non coplanar) portion of PCB.

(6) Radioactive exposure is not considered for the products listed here in.

(7) Gallium arsenide is used in some of the products listed in this publication. These products are dangerous if they are burned or shredded in the process of disposal. It is also dangerous to drink the liquid or inhale the gas generated by such products when chemically disposed of.

(8) This device should not be used in any type of fluid such as water, oil, organic solvent and etc.

(9) When the LEDs are in operation the maximum current should be decided after measuring the package temperature.

(10) The appearance and specifications of the product may be modified for improvement without notice.

(11) Long time exposure of sunlight or occasional UV exposure will cause lens discoloration.

## Precaution for Use

(12) VOCs (Volatile organic compounds) emitted from materials used in the construction of fixtures can penetrate silicone encapsulants of LEDs and discolor when exposed to heat and photonic energy. The result can be a significant loss of light output from the fixture. Knowledge of the properties of the materials selected to be used in the construction of fixtures can help prevent these issues.

(13) The slug is electrically isolated.

(14) Attaching LEDs, do not use adhesives that outgas organic vapor.

(15) The driving circuit must be designed to allow forward voltage only when it is ON or OFF. If the reverse voltage is applied to LED, migration can be generated resulting in LED damage.

(16) LEDs are sensitive to Electro-Static Discharge (ESD) and Electrical Over Stress (EOS). Below is a list of suggestions that Seoul Semiconductor purposes to minimize these effects.

### a. ESD (Electro Static Discharge)

Electrostatic discharge (ESD) is defined as the release of static electricity when two objects come into contact. While most ESD events are considered harmless, it can be an expensive problem in many industrial environments during production and storage. The damage from ESD to LEDs may cause the product to demonstrate unusual characteristics such as:

- Increase in reverse leakage current lowered turn-on voltage
- Abnormal emissions from the LED at low current

The following recommendations are suggested to help minimize the potential for an ESD event. One or more recommended work area suggestions:

- Ionizing fan setup
- ESD table/shelf mat made of conductive materials
- ESD safe storage containers

One or more personnel suggestion options:

- Antistatic wrist-strap
- Antistatic material shoes
- Antistatic clothes

Environmental controls:

- Humidity control (ESD gets worse in a dry environment)

## Precaution for Use

### b. EOS (Electrical Over Stress)

Electrical Over-Stress (EOS) is defined as damage that may occur when an electronic device is subjected to a current or voltage that is beyond the maximum specification limits of the device.

The effects from an EOS event can be noticed through product performance like:

- Changes to the performance of the LED package  
(If the damage is around the bond pad area and since the package is completely encapsulated the package may turn on but flicker show severe performance degradation.)
- Changes to the light output of the luminaire from component failure
- Components on the board not operating at determined drive power

Failure of performance from entire fixture due to changes in circuit voltage and current across total circuit causing trickle down failures. It is impossible to predict the failure mode of every LED exposed to electrical overstress as the failure modes have been investigated to vary, but there are some common signs that will indicate an EOS event has occurred:

- Damaged may be noticed to the bond wires (appearing similar to a blown fuse)
- Damage to the bond pads located on the emission surface of the LED package  
(shadowing can be noticed around the bond pads while viewing through a microscope)
- Anomalies noticed in the encapsulation and phosphor around the bond wires.
- This damage usually appears due to the thermal stress produced during the EOS event.

### c. To help minimize the damage from an EOS event Seoul Semiconductor recommends utilizing:

- A surge protection circuit
- An appropriately rated over voltage protection device
- A current limiting device



## Company Information

### Published by

Seoul Semiconductor © 2013 All Rights Reserved.

### Company Information

Seoul Semiconductor ([www.SeoulSemicon.com](http://www.SeoulSemicon.com)) manufactures and packages a wide selection of light emitting diodes (LEDs) for the automotive, general illumination/lighting, Home appliance, signage and back lighting markets. The company is the world's fifth largest LED supplier, holding more than 10,000 patents globally, while offering a wide range of LED technology and production capacity in areas such as "nPola", "Acrich", the world's first commercially produced AC LED, and "Acrich MJT - Multi-Junction Technology" a proprietary family of high-voltage LEDs.

The company's broad product portfolio includes a wide array of package and device choices such as Acrich and Acirch2, high-brightness LEDs, mid-power LEDs, side-view LEDs, and through-hole type LEDs as well as custom modules, displays, and sensors.

### Legal Disclaimer

Information in this document is provided in connection with Seoul Semiconductor products. With respect to any examples or hints given herein, any typical values stated herein and/or any information regarding the application of the device, Seoul Semiconductor hereby disclaims any and all warranties and liabilities of any kind, including without limitation, warranties of non-infringement of intellectual property rights of any third party. The appearance and specifications of the product can be changed to improve the quality and/or performance without notice.