

LMT87/LMT87-Q1 SC70/TO-92, Analog Temperature Sensors with Class-AB Output

1 Features

- LMT87-Q1 is AEC-Q100 Grade 0 Qualified and is Manufactured on an Automotive Grade Flow
- Very Accurate: $\pm 0.3^{\circ}\text{C}$ typical
- Wide Temperature Range of -50°C to 150°C
- Low $5.4\text{-}\mu\text{A}$ Quiescent Current
- Sensor Gain of $-13.6\text{ mV}/^{\circ}\text{C}$
- Packages:
 - Small SC70 (SOT 5-lead) Surface Mount
 - Leaded TO-92
- Output is Short-Circuit Protected
- Push-Pull Output with $50\text{-}\mu\text{A}$ Source Current Capability
- Footprint Compatible with the Industry-Standard LM20/19 and LM35 Temperature Sensors
- Cost-Effective Alternative to Thermistors

2 Applications

- Automotive
- Industrial
- White Goods – Appliances
- Battery Management
- Disk Drives
- Games
- Wireless Transceivers
- Cell phones

3 Description

The LMT87 and LMT87-Q1 are precision CMOS integrated-circuit temperature sensors with an analog output voltage that is linearly and inversely proportional to temperature. Its features make it suitable for many general temperature sensing applications. It can operate down to 2.7-V supply with $5.4\text{-}\mu\text{A}$ power consumption. Package options including through-hole TO-92 package allows the LMT87 to be mounted on-board, off-board, to a heat sink, or on multiple unique locations in the same application. A class-AB output structure gives the LMT87 and LMT87-Q1 strong output source and sink current capability that can directly drive up to 1.1-nF capacitive loads. This means it is well suited to drive an analog-to-digital converter sample-and-hold input with its transient load requirements. It has accuracy specified in the operating range of -50°C to 150°C . The accuracy, 3-lead package options, and other features also make the LMT87 and LMT87-Q1 an alternative to thermistors.

For devices with different average sensor gains and comparable accuracy, the LMT84/LM84-Q1, LMT85/LMT85-Q1, and LMT86/LMT86-Q1 (For more details, see .)

Device Information⁽¹⁾

PART NUMBER	PACKAGE	BODY SIZE (NOM)
LMT87	SOT (5)	2.00 mm x 1.25 mm
	TO-92 (3)	4.3 mm x 3.5 mm
LMT87-Q1	SOT (5)	2.00 mm x 1.25 mm

(1) For all available packages, see the orderable addendum addendum at the end of the data sheet.

4 Full-Range Celsius Temperature Sensor (-50°C to 150°C)

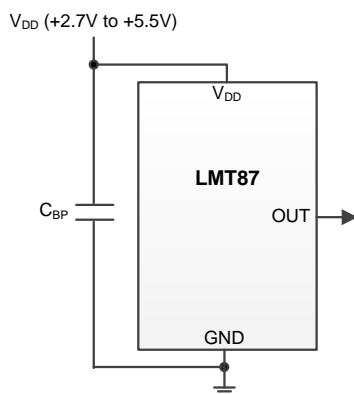

Output Voltage vs Temperature

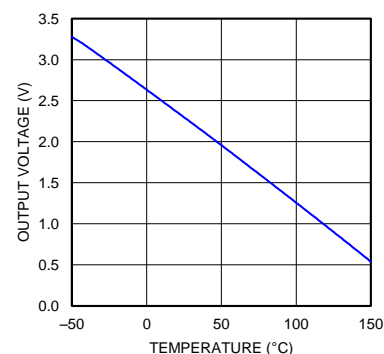

Table of Contents

1	Features	1	8.2	Functional Block Diagram	9
2	Applications	1	8.3	Feature Description	9
3	Description	1	8.4	Device Functional Modes	11
4	Full-Range Celsius Temperature Sensor (–50°C to 150°C)	1	9	Application and Implementation	12
5	Revision History	2	9.1	Application Information	12
6	Pin Configuration and Functions	4	9.2	Typical Applications	12
7	Specifications	5	10	Power Supply Recommendations	14
7.1	Absolute Maximum Ratings	5	11	Layout	14
7.2	ESD Ratings - Commercial	5	11.1	Layout Guidelines	14
7.3	ESD Ratings - Automotive	5	11.2	Layout Example	15
7.4	Recommended Operating Conditions	5	12	Device and Documentation Support	16
7.5	Thermal Information	6	12.1	Related Links	16
7.6	Accuracy Characteristics	6	12.2	Community Resources	16
7.7	Electrical Characteristics	6	12.3	Trademarks	16
7.8	Typical Characteristics	7	12.4	Electrostatic Discharge Caution	16
8	Detailed Description	9	12.5	Glossary	16
8.1	Overview	9	13	Mechanical, Packaging, and Orderable Information	16

5 Revision History

Changes from Revision B (May 2014) to Revision C	Page
• Deleted all mentions of TO-126 package	1
• Added TO-92 LPM pin configuration graphic	4
• Changed Handling Ratings to ESD Ratings and moved Storage Temperature to Absolute Maximum Ratings table	5
• Changed KV to V	5
• Added layout recommendation for TO-92 LP and LPM packages	15
• Added <i>Community Resources</i>	16

Changes from Revision A (June 2013) to Revision B	Page
• Added data sheet flow and layout to conform with new TI standards. Added the following sections: Application and Implementation, Power Supply Recommendations, Layout, Device and Documentation Support, Mechanical, Packaging, and Orderable Information	1
• Added TO-92 and TO-126 package information.	1
• Changed 450 °C/W to 275 °C/W. New specification is derived using TI 's latest methodology.	6
• Deleted Note: The input current is leakage only and is highest at high temperature. It is typically only 0.001 μA. The 1 μA limit is solely based on a testing limitation and does not reflect the actual performance of the part	6

Device Comparison⁽¹⁾

ORDER NUMBER	PACKAGE	PIN	BODY SIZE (NOM)	MOUNTING TYPE
LMT87DCK	SOT (AKA ⁽²⁾ : SC70, DCK)	5	2.00 mm x 1.25 mm	Surface mount
LMT87LP	TO-92 (AKA ⁽²⁾ : LP)	3	4.3 mm x 3.5 mm	Through-hole; straight leads
LMT87LPM	TO-92 (AKA ⁽²⁾ : LPM)	3	4.3 mm x 3.5 mm	Through-hole; formed leads
LMT87DCK-Q1	SOT (AKA ⁽²⁾ : SC70, DCK)	5	2.00 mm x 1.25 mm	Surface mount

(1) For all available packages and complete order numbers, see the orderable addendum at the end of the data sheet.

(2) AKA = Also Known As

Comparable Alternative Devices

PART NUMBER	AVERAGE OUTPUT SENSOR GAIN	POWER SUPPLY RANGE
LMT84/LMT84-Q1	-5.5 mV/°C	1.5 V to 5.5 V
LMT85/LMT85-Q1	-8.2 mV/°C	1.8 V to 5.5 V
LMT86/LMT86-Q1	-10.9 mV/°C	2.2 V to 5.5 V
LMT87/LMT87-Q1	-13.6 mV/°C	2.7 V to 5.5 V

6 Pin Configuration and Functions

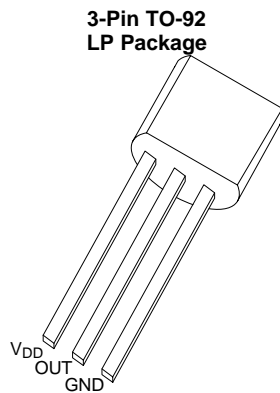
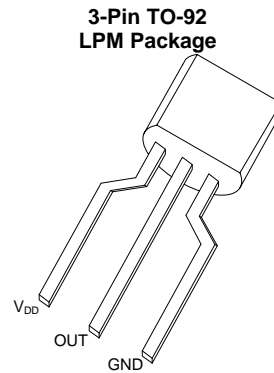
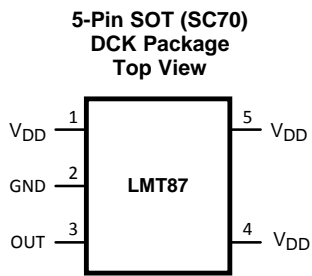

Pin Functions

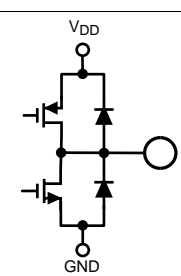
PIN				DESCRIPTION		
LABEL	DCK NUMBER	LP NUMBER	LPC NUMBER	TYPE	EQUIVALENT CIRCUIT	FUNCTION
V _{DD}	5	See Pin Diagrams	See Pin Diagrams	Power		Power Supply Voltage
V _{DD}	1			Power		Power Supply Voltage
OUT	3			Analog Output		Outputs a voltage which is inversely proportional to temperature
V _{DD}	4			Power		Positive Supply Voltage
GND	2			Ground		Power Supply Ground, (direct connection to the back side of the die)

7 Specifications

7.1 Absolute Maximum Ratings

over operating free-air temperature range (unless otherwise noted)⁽¹⁾⁽²⁾

	MIN	MAX	UNIT
Supply Voltage	-0.3	6	V
Voltage at Output Pin	-0.3	(V _{DD} + 0.5)	V
Output Current	-7	7	mA
Input Current at Any Pin ⁽³⁾	-5	5	mA
T _{JMAX} Maximum Junction Temperature		150	°C
T _{stg} Storage Temperature	-65	150	°C

- Stresses beyond those listed under *Absolute Maximum Ratings* may cause permanent damage to the device. These are stress ratings only, which do not imply functional operation of the device at these or any other conditions beyond those indicated under *Recommended Operating Conditions*. Exposure to absolute-maximum-rated conditions for extended periods may affect device reliability.
- Soldering process must comply with TI's Reflow Temperature Profile specifications. Refer to www.ti.com/packaging. Reflow temperature profiles are different for lead-free and non-lead-free packages.
- When the input voltage (V_I) at any pin exceeds power supplies (V_I < GND or V_I > V), the current at that pin should be limited to 5 mA.

7.2 ESD Ratings - Commercial

		VALUE	UNIT
V _{ESD} Electrostatic discharge	Human body model (HBM), per ANSI/ESDA/JEDEC JS-001, all pins. ⁽¹⁾ Applies for TO-92 package LMT87LP.	±2500	V
	Human body model (HBM), per JESD22-A114, all pins. Applies for SC70 package LMT87DCK.	±2500	
	Charged device model (CDM), per JEDEC specification JESD22-C101, all pins. ⁽²⁾ Applies for all parts.	±1000	
	Machine model ESD stress voltage, per JEDEC specification JESD22-A115. ⁽³⁾ Applies for SC70 package LMT87DCK.	±250	

- JEDEC document JEP155 states that 500-V HBM allows safe manufacturing with a standard ESD control process.
- JEDEC document JEP157 states that 250-V CDM allows safe manufacturing with a standard ESD control process.
- The machine model is a 200-pF capacitor discharged directly into each pin.

7.3 ESD Ratings - Automotive

		VALUE	UNIT
V _(ESD) Electrostatic discharge	Human-body model (HBM), per JESD22-A114, all pins. ⁽¹⁾ Applies for SC70 package LMT87DCK-Q1.	±2500	V
	Charged-device model (CDM), per JEDEC specification JESD22-C101, all pins. ⁽²⁾ Applies for SC70 package LMT87DCK-Q1.	±1000	

- JEDEC document JEP155 states that 500-V HBM allows safe manufacturing with a standard ESD control process.
- JEDEC document JEP157 states that 250-V CDM allows safe manufacturing with a standard ESD control process.

7.4 Recommended Operating Conditions

	MIN	MAX	UNIT
Specified Temperature Range	T _{MIN} ≤ T _A ≤ T _{MAX}		°C
	-50 ≤ T _A ≤ 150		°C
V _{DD} Supply Voltage Range	2.7	5.5	V

7.5 Thermal Information

THERMAL METRIC ⁽¹⁾		LMT87 LMT87-Q1	LMT87	UNIT
		DCK	LP	
		5 PINS	3 PINS	
R _{θJA}	Junction-to-ambient thermal resistance ⁽²⁾⁽³⁾	275	167	°C/W
R _{θJC(top)}	Junction-to-case (top) thermal resistance	84	90	°C/W
R _{θJB}	Junction-to-board thermal resistance	56	146	°C/W
Ψ _{JT}	Junction-to-top characterization parameter	1.2	35	°C/W
Ψ _{JB}	Junction-to-board characterization parameter	55	146	°C/W

- (1) For more information about traditional and new thermal metrics, see the *Semiconductor and IC Package Thermal Metrics* application report (SPRA953).
- (2) The junction-to-ambient thermal resistance (R_{θJA}) under natural convection is obtained in a simulation on a JEDEC-standard, High K board as specified in JESD51-7, in an environment described in JESD51-2.
- (3) Changes in output due to self heating can be computed by multiplying the internal dissipation by the thermal resistance.

7.6 Accuracy Characteristics

These limits do not include DC load regulation. These stated accuracy limits are with reference to the values in Table 1.

PARAMETER	CONDITIONS	MIN ⁽¹⁾	TYP	MAX ⁽¹⁾	UNIT
Temperature accuracy ⁽²⁾	70°C to 150°C; V _{DD} = 3.0 V to 5.5 V	-2.7	±0.4	2.7	°C
	20°C to 40°C; V _{DD} = 2.7 V to 5.5 V		±0.6		°C
	20°C to 40°C; V _{DD} = 3.4 V to 5.5 V		±0.3		°C
	0°C; V _{DD} = 3.0 V to 5.5 V	-2.7	±0.6	2.7	°C
	0°C; V _{DD} = 3.6 V to 5.5 V		±0.3		°C
	-50°C; V _{DD} = 3.6 V to 5.5 V	-2.7	±0.6	2.7	°C
	-50°C; V _{DD} = 4.2 V to 5.5 V		±0.3		°C

- (1) Limits are specific to TI's AOQL (Average Outgoing Quality Level).
- (2) Accuracy is defined as the error between the measured and reference output voltages, tabulated in the Transfer Table at the specified conditions of supply gain setting, voltage, and temperature (expressed in °C). Accuracy limits include line regulation within the specified conditions. Accuracy limits do not include load regulation; they assume no DC load.

7.7 Electrical Characteristics

Unless otherwise noted, these specifications apply for +V_{DD} = 2.7 V to 5.5 V. MIN and MAX limits apply for T_A = T_J = T_{MIN} to T_{MAX}; typical limits apply for T_A = T_J = 25°C.

PARAMETER	CONDITIONS	MIN ⁽¹⁾	TYP ⁽²⁾	MAX ⁽¹⁾	UNIT
Sensor gain (output transfer function slope)			-13.6		mV/°C
Load regulation ⁽³⁾	Source ≤ 50 μA, (V _{DD} - V _{OUT}) ≥ 200 mV	-1	-0.22		mV
	Sink ≤ 50 μA, V _{OUT} ≥ 200 mV		0.26	1	mV
Line regulation ⁽⁴⁾			200		μV/V
I _S Supply current	T _A = 30°C to 150°C, (V _{DD} - V _{OUT}) ≥ 100 mV		5.4	8.1	μA
	T _A = -50°C to 150°C, (V _{DD} - V _{OUT}) ≥ 100 mV		5.4	9	μA
C _L Output load capacitance			1100		pF
Power-on time ⁽⁵⁾	C _L = 0 pF to 1100 pF		0.7	1.9	ms
Output drive	T _A = T _J = 25°C	-50		50	μA

- (1) Limits are specific to TI's AOQL (Average Outgoing Quality Level).
- (2) Typical values are at T_J = T_A = 25°C and represent most likely parametric norm.
- (3) Source currents are flowing out of the LMT87 and LMT87-Q1. Sink currents are flowing into the LMT87 and LMT87-Q1.
- (4) Line regulation (DC) is calculated by subtracting the output voltage at the highest supply voltage from the output voltage at the lowest supply voltage. The typical DC line regulation specification does not include the output voltage shift discussed in [Output Voltage Shift](#).
- (5) Specified by design and characterization.

7.8 Typical Characteristics

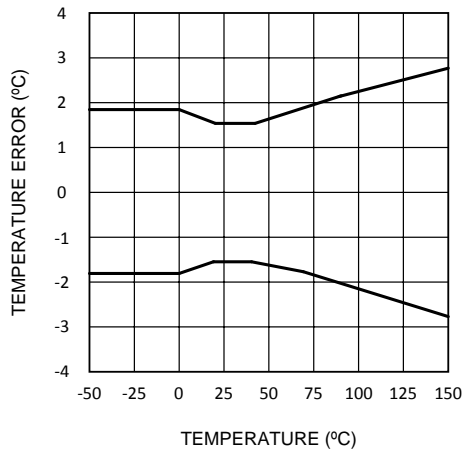

Figure 1. Temperature Error vs Temperature

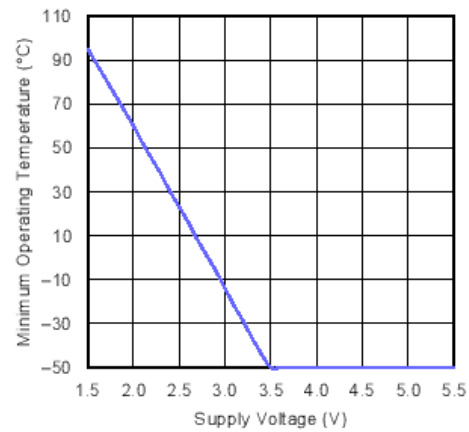

Figure 2. Minimum Operating Temperature vs Supply Voltage

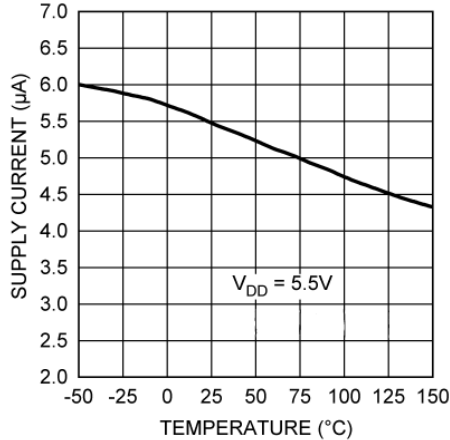

Figure 3. Supply Current vs Temperature

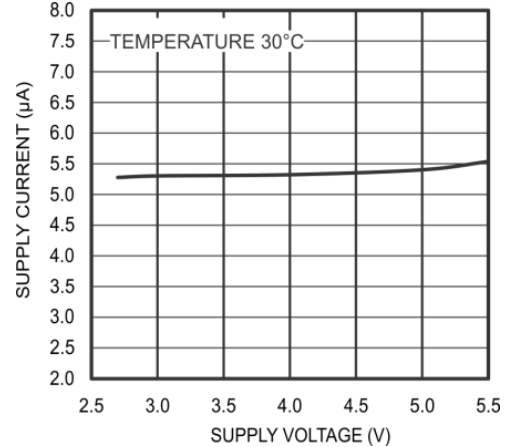

Figure 4. Supply Current vs Supply Voltage

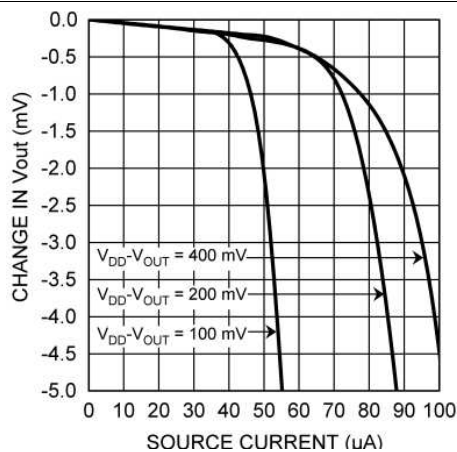

Figure 5. Load Regulation, Sourcing Current

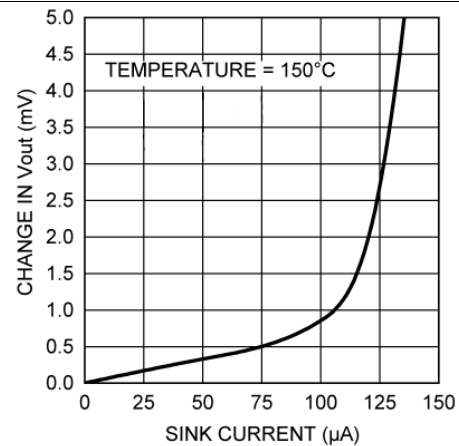

Figure 6. Load Regulation, Sinking Current

Typical Characteristics (continued)

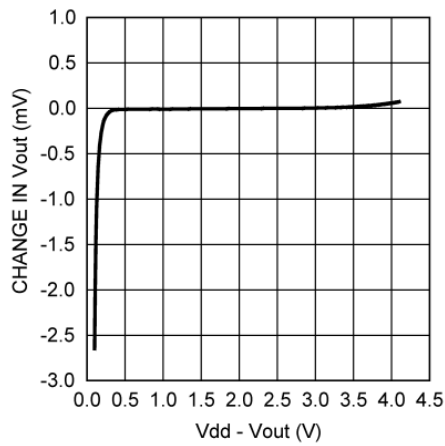

Figure 7. Change in V_{OUT} vs Overhead Voltage

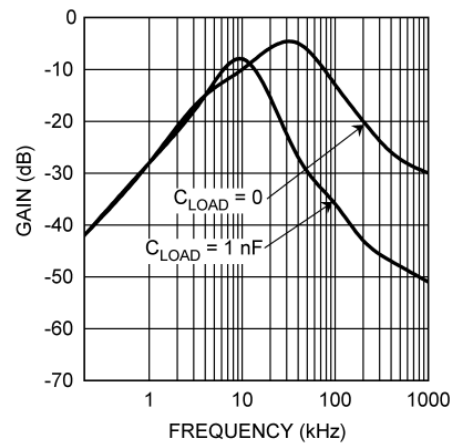

Figure 8. Supply-Noise Gain vs Frequency

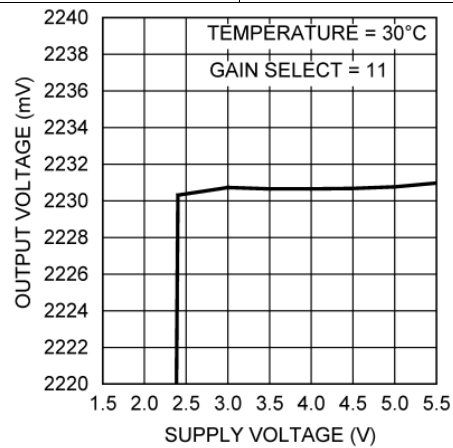

Figure 9. Output Voltage vs Supply Voltage

8 Detailed Description

8.1 Overview

The LMT87 and LMT87-Q1 are analog output temperature sensors. The temperature sensing element is comprised of a simple base emitter junction that is forward biased by a current source. The temperature sensing element is then buffered by an amplifier and provided to the OUT pin. The amplifier has a simple push-pull output stage thus providing a low impedance output source.

8.2 Functional Block Diagram

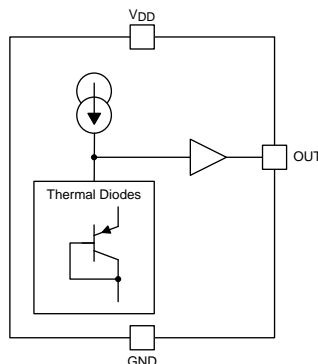

8.3 Feature Description

8.3.1 LMT87/LMT87-Q1 Transfer Function

The output voltage of the LMT87 and LMT87-Q1, across the complete operating temperature range is shown in [Table 1](#). This table is the reference from which the LMT87 and LMT87-Q1 accuracy specifications (listed in the [Accuracy Characteristics](#) section) are determined. This table can be used, for example, in a host processor look-up table. A file containing this data is available for download at [LMT87 product folder under Tools and Software Models](#).

Table 1. LMT87/LMT87-Q1 Transfer Table

TEMP (°C)	V _{OUT} (mV)	TEMP (°C)	V _{OUT} (mV)	TEMP (°C)	V _{OUT} (mV)	TEMP (°C)	V _{OUT} (mV)	TEMP (°C)	V _{OUT} (mV)
-50	3277	-10	2767	30	2231	70	1679	110	1115
-49	3266	-9	2754	31	2217	71	1665	111	1101
-48	3254	-8	2740	32	2204	72	1651	112	1087
-47	3243	-7	2727	33	2190	73	1637	113	1073
-46	3232	-6	2714	34	2176	74	1623	114	1058
-45	3221	-5	2700	35	2163	75	1609	115	1044
-44	3210	-4	2687	36	2149	76	1595	116	1030
-43	3199	-3	2674	37	2136	77	1581	117	1015
-42	3186	-2	2660	38	2122	78	1567	118	1001
-41	3173	-1	2647	39	2108	79	1553	119	987
-40	3160	0	2633	40	2095	80	1539	120	973
-39	3147	1	2620	41	2081	81	1525	121	958
-38	3134	2	2607	42	2067	82	1511	122	944
-37	3121	3	2593	43	2054	83	1497	123	929
-36	3108	4	2580	44	2040	84	1483	124	915
-35	3095	5	2567	45	2026	85	1469	125	901
-34	3082	6	2553	46	2012	86	1455	126	886
-33	3069	7	2540	47	1999	87	1441	127	872

Table 1. LMT87/LMT87-Q1 Transfer Table (continued)

TEMP (°C)	V _{OUT} (mV)	TEMP (°C)	V _{OUT} (mV)	TEMP (°C)	V _{OUT} (mV)	TEMP (°C)	V _{OUT} (mV)	TEMP (°C)	V _{OUT} (mV)
-32	3056	8	2527	48	1985	88	1427	128	858
-31	3043	9	2513	49	1971	89	1413	129	843
-30	3030	10	2500	50	1958	90	1399	130	829
-29	3017	11	2486	51	1944	91	1385	131	814
-28	3004	12	2473	52	1930	92	1371	132	800
-27	2991	13	2459	53	1916	93	1356	133	786
-26	2978	14	2446	54	1902	94	1342	134	771
-25	2965	15	2433	55	1888	95	1328	135	757
-24	2952	16	2419	56	1875	96	1314	136	742
-23	2938	17	2406	57	1861	97	1300	137	728
-22	2925	18	2392	58	1847	98	1286	138	713
-21	2912	19	2379	59	1833	99	1272	139	699
-20	2899	20	2365	60	1819	100	1257	140	684
-19	2886	21	2352	61	1805	101	1243	141	670
-18	2873	22	2338	62	1791	102	1229	142	655
-17	2859	23	2325	63	1777	103	1215	143	640
-16	2846	24	2311	64	1763	104	1201	144	626
-15	2833	25	2298	65	1749	105	1186	145	611
-14	2820	26	2285	66	1735	106	1172	146	597
-13	2807	27	2271	67	1721	107	1158	147	582
-12	2793	28	2258	68	1707	108	1144	148	568
-11	2780	29	2244	69	1693	109	1130	149	553
								150	538

Although the LMT87 and LMT87-Q1 is very linear, its response does have a slight umbrella parabolic shape. This shape is very accurately reflected in [Table 1](#). The Transfer Table can be calculated by using the parabolic equation.

$$V_{TEMP} (mV) = 2230.8mV - \left[13.582 \frac{mV}{^{\circ}C} (T - 30^{\circ}C) \right] - \left[0.00433 \frac{mV}{^{\circ}C^2} (T - 30^{\circ}C)^2 \right] \quad (1)$$

The parabolic equation is an approximation of the transfer table and the accuracy of the equation degrades slightly at the temperature range extremes. [Equation 1](#) can be solved for T resulting in:

$$T = \frac{13.582 - \sqrt{(-13.582)^2 + 4 \times 0.00433 \times (2230.8 - V_{TEMP} (mV))}}{2 \times (-0.00433)} + 30 \quad (2)$$

For an even less accurate linear transfer function approximation, a line can easily be calculated over the desired temperature range from the Table using the two-point equation:

$$V - V_1 = \left(\frac{V_2 - V_1}{T_2 - T_1} \right) \times (T - T_1) \quad (3)$$

Where V is in mV, T is in °C, T₁ and V₁ are the coordinates of the lowest temperature, T₂ and V₂ are the coordinates of the highest temperature.

For example, if we want to resolve this equation, over a temperature range of 20°C to 50°C, we would proceed as follows:

$$V - 2365 mV = \left(\frac{1958 mV - 2365 mV}{50^{\circ}C - 20^{\circ}C} \right) \times (T - 20^{\circ}C) \quad (4)$$

$$V - 2365 mV = (-13.6 mV / ^{\circ}C) \times (T - 20^{\circ}C) \quad (5)$$

$$V = (-13.6 mV / ^{\circ}C) \times T + 2637 mV \quad (6)$$

Using this method of linear approximation, the transfer function can be approximated for one or more temperature ranges of interest.

8.4 Device Functional Modes

8.4.1 Mounting and Thermal Conductivity

The LMT87 and LMT87-Q1 can be applied easily in the same way as other integrated-circuit temperature sensors. It can be glued or cemented to a surface.

To ensure good thermal conductivity, the backside of the LMT87 and LMT87-Q1 die is directly attached to the GND pin (Pin 2 of the SC70 DCK package). The temperatures of the lands and traces to the other leads of the LMT87 and LMT87-Q1 will also affect the temperature reading.

Alternatively, the LMT87 and LMT87-Q1 can be mounted inside a sealed-end metal tube, and can then be dipped into a bath or screwed into a threaded hole in a tank. As with any IC, the LMT87 and LMT87-Q1 and accompanying wiring and circuits must be kept insulated and dry, to avoid leakage and corrosion. This is especially true if the circuit may operate at cold temperatures where condensation can occur. If moisture creates a short circuit from the output to ground or V_{DD} , the output from the LMT87 and LMT87-Q1 will not be correct. Printed-circuit coatings are often used to ensure that moisture cannot corrode the leads or circuit traces.

The thermal resistance junction to ambient ($R_{\theta JA}$ or θ_{JA}) is the parameter used to calculate the rise of a device junction temperature due to its power dissipation. The equation used to calculate the rise in the LMT87 and LMT87-Q1's die temperature is:

$$T_J = T_A + \theta_{JA} [(V_{DD} I_S) + (V_{DD} - V_{OUT}) I_L] \quad (7)$$

where T_A is the ambient temperature, I_S is the supply current, I_L is the load current on the output, and V_{OUT} is the output voltage. For example, in an application where $T_A = 30^\circ\text{C}$, $V_{DD} = 5\text{ V}$, $I_S = 5.4\ \mu\text{A}$, $V_{OUT} = 2231\text{ mV}$, and $I_L = 2\ \mu\text{A}$, the junction temperature would be 30.014°C , showing a self-heating error of only 0.014°C . Since the junction temperature of the LMT87 and LMT87-Q1 is the actual temperature being measured, care should be taken to minimize the load current that the LMT87 and LMT87-Q1 is required to drive. [Thermal Information](#) shows the thermal resistance of the LMT87 and LMT87-Q1.

8.4.2 Output Noise Considerations

A push-pull output gives the LMT87 and LMT87-Q1 the ability to sink and source significant current. This is beneficial when, for example, driving dynamic loads like an input stage on an analog-to-digital converter (ADC). In these applications the source current is required to quickly charge the input capacitor of the ADC. The LMT87 and LMT87-Q1 is ideal for this and other applications which require strong source or sink current.

The LMT87 and LMT87-Q1 supply-noise gain (the ratio of the AC signal on V_{OUT} to the AC signal on V_{DD}) was measured during bench tests. Its typical attenuation is shown in [Figure 8](#) found in the Typical Characteristics section. A load capacitor on the output can help to filter noise.

For operation in very noisy environments, some bypass capacitance should be present on the supply within approximately 5 centimeters of the LMT87 and LMT87-Q1.

8.4.3 Capacitive Loads

The LMT87 and LMT87-Q1 handles capacitive loading well. In an extremely noisy environment, or when driving a switched sampling input on an ADC, it may be necessary to add some filtering to minimize noise coupling. Without any precautions, the LMT87 and LMT87-Q1 can drive a capacitive load less than or equal to 1100 pF , as shown in [Figure 10](#). For capacitive loads greater than 1100 pF , a series resistor may be required on the output, as shown in [Figure 11](#).

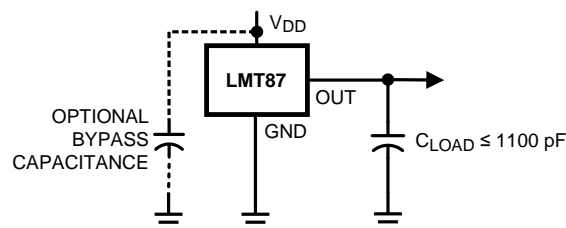

Figure 10. LMT87 No Decoupling Required for Capacitive Loads Less than 1100 pF

Device Functional Modes (continued)

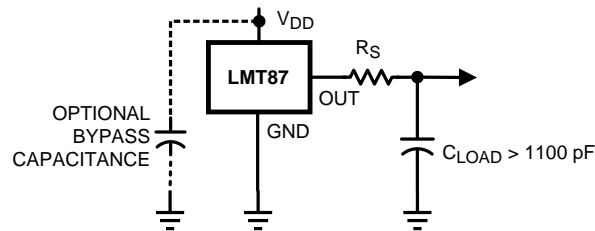

Figure 11. LMT87 with Series Resistor for Capacitive Loading Greater than 1100 pF

C _{LOAD}	MINIMUM R _S
1.1 nF to 99 nF	3 kΩ
100 nF to 999 nF	1.5 kΩ
1 μF	800 Ω

8.4.4 Output Voltage Shift

The LMT87 and LMT87-Q1 is very linear over temperature and supply voltage range. Due to the intrinsic behavior of an NMOS/PMOS rail-to-rail buffer, a slight shift in the output can occur when the supply voltage is ramped over the operating range of the device. The location of the shift is determined by the relative levels of V_{DD} and V_{OUT} . The shift typically occurs when $V_{DD} - V_{OUT} = 1$ V.

This slight shift (a few millivolts) takes place over a wide change (approximately 200 mV) in V_{DD} or V_{OUT} . Since the shift takes place over a wide temperature change of 5°C to 20°C, V_{OUT} is always monotonic. The accuracy specifications in the [Accuracy Characteristics](#) table already include this possible shift.

9 Application and Implementation

9.1 Application Information

The LMT87/LMT87-Q1 features make it suitable for many general temperature sensing applications. It can operate down to 2.7-V supply with 5.4-μA power consumption. Package options including through-hole TO-92 package also allows the LMT87 to be mounted on-board, off-board, to a heat sink, or on multiple unique locations in the same application.

9.2 Typical Applications

9.2.1 Connection to ADC

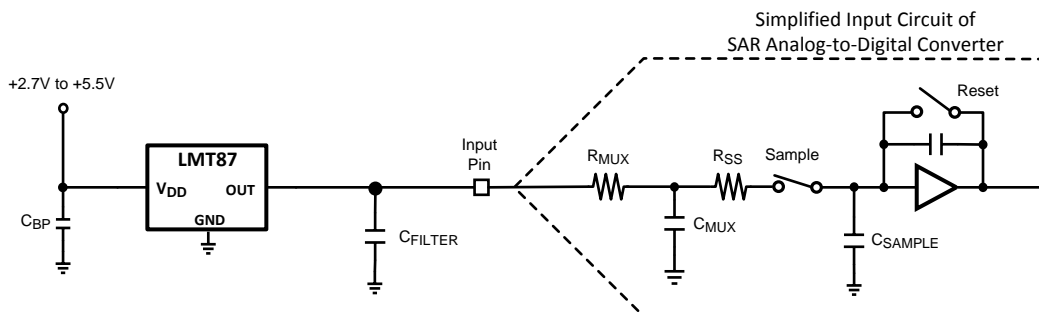

Figure 12. Suggested Connection to a Sampling Analog-to-Digital Converter Input Stage

Typical Applications (continued)

9.2.1.1 Design Requirements

Most CMOS ADCs found in microcontrollers and ASICs have a sampled data comparator input structure. When the ADC charges the sampling cap, it requires instantaneous charge from the output of the analog source such as the LMT87 and LMT87-Q1 temperature sensor and many op amps. This requirement is easily accommodated by the addition of a capacitor (C_{FILTER}).

9.2.1.2 Detailed Design Procedure

The size of C_{FILTER} depends on the size of the sampling capacitor and the sampling frequency. Since not all ADCs have identical input stages, the charge requirements will vary. This general ADC application is shown as an example only.

9.2.1.3 Application Curves

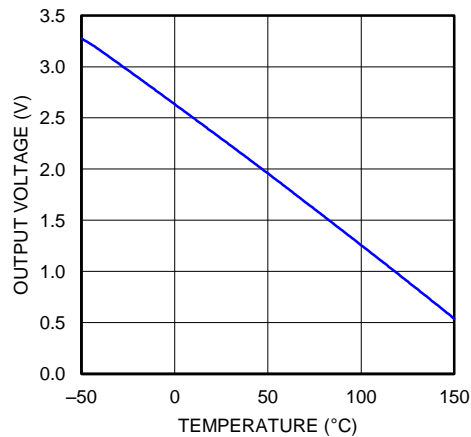

Figure 13. Analog Output Transfer Function

9.2.2 Conserving Power Dissipation with Shutdown

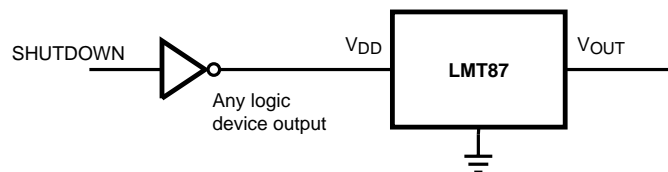

Figure 14. Simple Shutdown Connection of the LMT87

9.2.2.1 Design Requirements

Since the power consumption of the LMT87 is less than 9 μA , it can simply be powered directly from any logic gate output, thus not requiring a specific shutdown pin. The device can even be powered directly from a microcontroller GPIO. In this way it can easily be turned off for cases such as battery powered systems where power savings is critical.

9.2.2.2 Detailed Design Procedure

Simply connect the V_{DD} pin of the LMT87 directly to the logic shutdown signal from a microcontroller.

Typical Applications (continued)

9.2.2.3 Application Curves

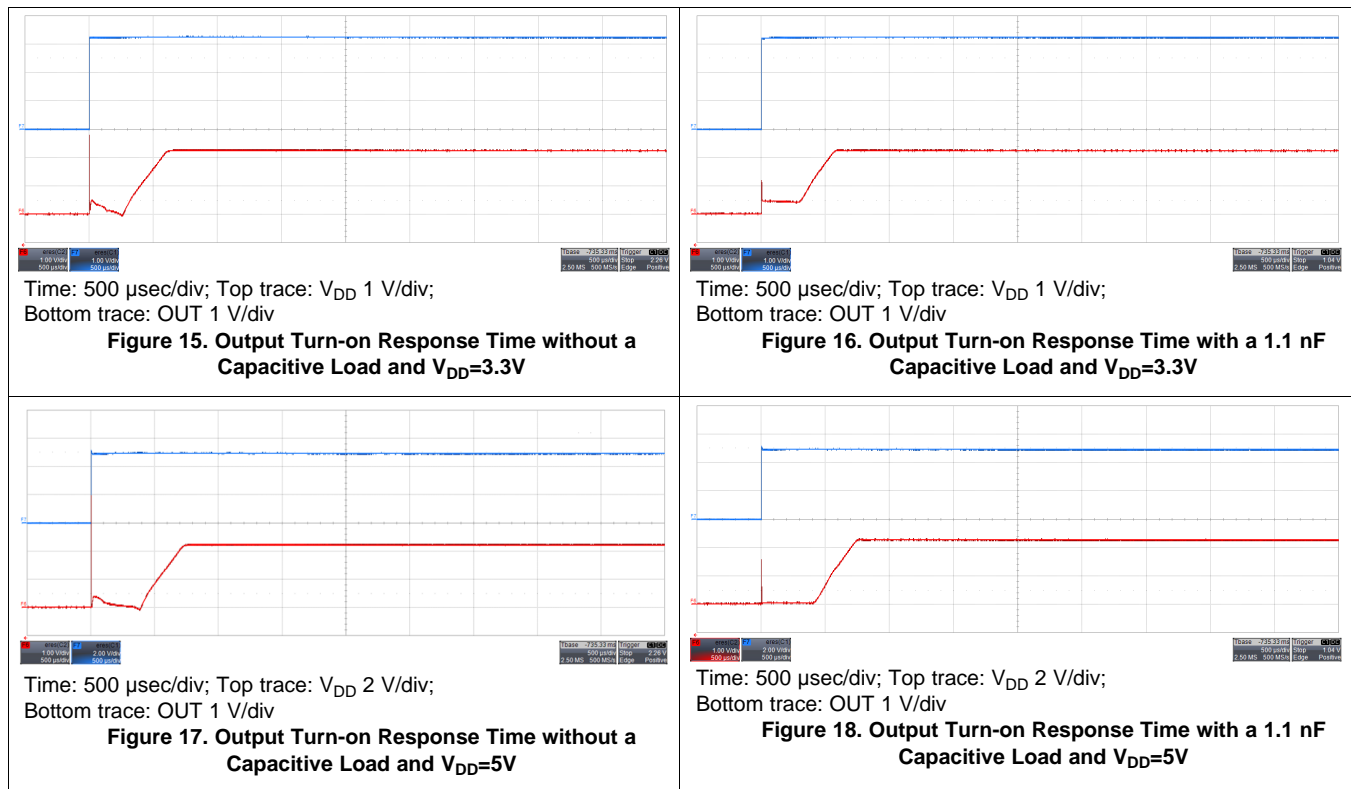

10 Power Supply Recommendations

The low supply current and supply range of 2.7 V to 5.5 V allow the device to easily be powered from many sources.

Power supply bypassing is optional and is mainly dependent on the noise on the power supply used. In noisy systems it may be necessary to add bypass capacitors to lower the noise that is coupled to the output of the LMT87.

11 Layout

11.1 Layout Guidelines

The LMT87 is extremely simple to layout. If a power supply bypass capacitor is used, it should be connected as shown in the [Layout Example](#).

11.2 Layout Example

○ VIA to ground plane

○ VIA to power plane

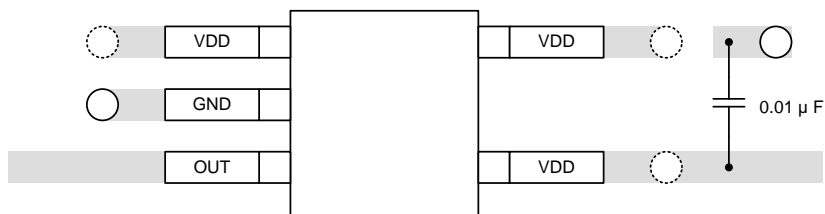

Figure 19. SC70 Package Recommended Layout

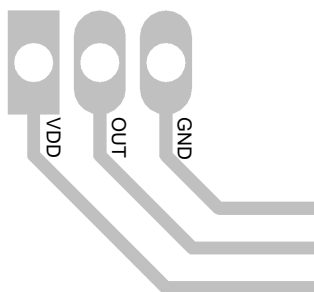

Figure 20. TO-92 LP Package Recommended Layout

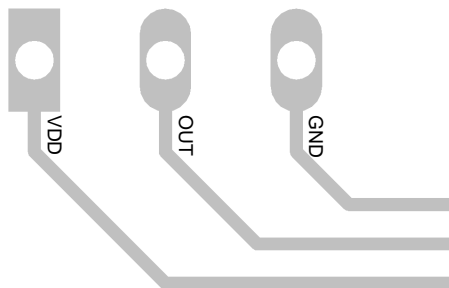

Figure 21. TO-92 LPM Package Recommended Layout

12 Device and Documentation Support

12.1 Related Links

The table below lists quick access links. Categories include technical documents, support and community resources, tools and software, and quick access to sample or buy.

Table 2. Related Links

PARTS	PRODUCT FOLDER	SAMPLE & BUY	TECHNICAL DOCUMENTS	TOOLS & SOFTWARE	SUPPORT & COMMUNITY
LMT87	Click here	Click here	Click here	Click here	Click here
LMT87-Q1	Click here	Click here	Click here	Click here	Click here

12.2 Community Resources

The following links connect to TI community resources. Linked contents are provided "AS IS" by the respective contributors. They do not constitute TI specifications and do not necessarily reflect TI's views; see TI's [Terms of Use](#).

TI E2E™ Online Community *TI's Engineer-to-Engineer (E2E) Community*. Created to foster collaboration among engineers. At e2e.ti.com, you can ask questions, share knowledge, explore ideas and help solve problems with fellow engineers.

Design Support *TI's Design Support* Quickly find helpful E2E forums along with design support tools and contact information for technical support.

12.3 Trademarks

E2E is a trademark of Texas Instruments.
All other trademarks are the property of their respective owners.

12.4 Electrostatic Discharge Caution



These devices have limited built-in ESD protection. The leads should be shorted together or the device placed in conductive foam during storage or handling to prevent electrostatic damage to the MOS gates.

12.5 Glossary

SLYZ022 — *TI Glossary*.

This glossary lists and explains terms, acronyms, and definitions.

13 Mechanical, Packaging, and Orderable Information

The following pages include mechanical, packaging, and orderable information. This information is the most current data available for the designated devices. This data is subject to change without notice and revision of this document. For browser-based versions of this data sheet, refer to the left-hand navigation.

PACKAGING INFORMATION

Orderable Device	Status (1)	Package Type	Package Drawing	Pins	Package Qty	Eco Plan (2)	Lead/Ball Finish (6)	MSL Peak Temp (3)	Op Temp (°C)	Device Marking (4/5)	Samples
LMT87DCKR	ACTIVE	SC70	DCK	5	3000	Green (RoHS & no Sb/Br)	CU SN	Level-1-260C-UNLIM	-50 to 150	BUA	Samples
LMT87DCKT	ACTIVE	SC70	DCK	5	250	Green (RoHS & no Sb/Br)	CU SN	Level-1-260C-UNLIM	-50 to 150	BUA	Samples
LMT87LP	ACTIVE	TO-92	LP	3	1800	Green (RoHS & no Sb/Br)	CU SN	N / A for Pkg Type	-50 to 150	LMT87	Samples
LMT87LPM	ACTIVE	TO-92	LP	3	2000	Green (RoHS & no Sb/Br)	CU SN	N / A for Pkg Type	-50 to 150	LMT87	Samples
LMT87QDCKRQ1	ACTIVE	SC70	DCK	5	3000	Green (RoHS & no Sb/Br)	CU SN	Level-1-260C-UNLIM	-50 to 150	BVA	Samples
LMT87QDCKTQ1	ACTIVE	SC70	DCK	5	250	Green (RoHS & no Sb/Br)	CU SN	Level-1-260C-UNLIM	-50 to 150	BVA	Samples

(1) The marketing status values are defined as follows:

ACTIVE: Product device recommended for new designs.

LIFEBUY: TI has announced that the device will be discontinued, and a lifetime-buy period is in effect.

NRND: Not recommended for new designs. Device is in production to support existing customers, but TI does not recommend using this part in a new design.

PREVIEW: Device has been announced but is not in production. Samples may or may not be available.

OBSELETE: TI has discontinued the production of the device.

(2) Eco Plan - The planned eco-friendly classification: Pb-Free (RoHS), Pb-Free (RoHS Exempt), or Green (RoHS & no Sb/Br) - please check <http://www.ti.com/productcontent> for the latest availability information and additional product content details.

TBD: The Pb-Free/Green conversion plan has not been defined.

Pb-Free (RoHS): TI's terms "Lead-Free" or "Pb-Free" mean semiconductor products that are compatible with the current RoHS requirements for all 6 substances, including the requirement that lead not exceed 0.1% by weight in homogeneous materials. Where designed to be soldered at high temperatures, TI Pb-Free products are suitable for use in specified lead-free processes.

Pb-Free (RoHS Exempt): This component has a RoHS exemption for either 1) lead-based flip-chip solder bumps used between the die and package, or 2) lead-based die adhesive used between the die and leadframe. The component is otherwise considered Pb-Free (RoHS compatible) as defined above.

Green (RoHS & no Sb/Br): TI defines "Green" to mean Pb-Free (RoHS compatible), and free of Bromine (Br) and Antimony (Sb) based flame retardants (Br or Sb do not exceed 0.1% by weight in homogeneous material)

(3) MSL, Peak Temp. - The Moisture Sensitivity Level rating according to the JEDEC industry standard classifications, and peak solder temperature.

(4) There may be additional marking, which relates to the logo, the lot trace code information, or the environmental category on the device.

(5) Multiple Device Markings will be inside parentheses. Only one Device Marking contained in parentheses and separated by a "~" will appear on a device. If a line is indented then it is a continuation of the previous line and the two combined represent the entire Device Marking for that device.

⁽⁶⁾ Lead/Ball Finish - Orderable Devices may have multiple material finish options. Finish options are separated by a vertical ruled line. Lead/Ball Finish values may wrap to two lines if the finish value exceeds the maximum column width.

Important Information and Disclaimer: The information provided on this page represents TI's knowledge and belief as of the date that it is provided. TI bases its knowledge and belief on information provided by third parties, and makes no representation or warranty as to the accuracy of such information. Efforts are underway to better integrate information from third parties. TI has taken and continues to take reasonable steps to provide representative and accurate information but may not have conducted destructive testing or chemical analysis on incoming materials and chemicals. TI and TI suppliers consider certain information to be proprietary, and thus CAS numbers and other limited information may not be available for release.

In no event shall TI's liability arising out of such information exceed the total purchase price of the TI part(s) at issue in this document sold by TI to Customer on an annual basis.

OTHER QUALIFIED VERSIONS OF LMT87, LMT87-Q1 :

- Catalog: [LMT87](#)
- Automotive: [LMT87-Q1](#)

NOTE: Qualified Version Definitions:

- Catalog - TI's standard catalog product
- Automotive - Q100 devices qualified for high-reliability automotive applications targeting zero defects

TAPE AND REEL INFORMATION

QUADRANT ASSIGNMENTS FOR PIN 1 ORIENTATION IN TAPE

*All dimensions are nominal

Device	Package Type	Package Drawing	Pins	SPQ	Reel Diameter (mm)	Reel Width W1 (mm)	A0 (mm)	B0 (mm)	K0 (mm)	P1 (mm)	W (mm)	Pin1 Quadrant
LMT87DCKR	SC70	DCK	5	3000	178.0	8.4	2.25	2.45	1.2	4.0	8.0	Q3
LMT87DCKT	SC70	DCK	5	250	178.0	8.4	2.25	2.45	1.2	4.0	8.0	Q3
LMT87QDCKRQ1	SC70	DCK	5	3000	178.0	8.4	2.25	2.45	1.2	4.0	8.0	Q3
LMT87QDCKTQ1	SC70	DCK	5	250	178.0	8.4	2.25	2.45	1.2	4.0	8.0	Q3

TAPE AND REEL BOX DIMENSIONS

*All dimensions are nominal

Device	Package Type	Package Drawing	Pins	SPQ	Length (mm)	Width (mm)	Height (mm)
LMT87DCKR	SC70	DCK	5	3000	210.0	185.0	35.0
LMT87DCKT	SC70	DCK	5	250	210.0	185.0	35.0
LMT87QDCKRQ1	SC70	DCK	5	3000	210.0	185.0	35.0
LMT87QDCKTQ1	SC70	DCK	5	250	210.0	185.0	35.0

GENERIC PACKAGE VIEW

LP 3

TO-92 - 5.34 mm max height

TRANSISTOR OUTLINE



Images above are just a representation of the package family, actual package may vary.
Refer to the product data sheet for package details.

4040001-2/F

LP0003A



PACKAGE OUTLINE

TO-92 - 5.34 mm max height

TO-92



4215214/B 04/2017

NOTES:

1. All linear dimensions are in millimeters. Any dimensions in parenthesis are for reference only. Dimensioning and tolerancing per ASME Y14.5M.
2. This drawing is subject to change without notice.
3. Lead dimensions are not controlled within this area.
4. Reference JEDEC TO-226, variation AA.
5. Shipping method:
 - a. Straight lead option available in bulk pack only.
 - b. Formed lead option available in tape and reel or ammo pack.
 - c. Specific products can be offered in limited combinations of shipping medium and lead options.
 - d. Consult product folder for more information on available options.



LAND PATTERN EXAMPLE
STRAIGHT LEAD OPTION
NON-SOLDER MASK DEFINED
SCALE:15X



LAND PATTERN EXAMPLE
FORMED LEAD OPTION
NON-SOLDER MASK DEFINED
SCALE:15X

TAPE SPECIFICATIONS

LP0003A

TO-92 - 5.34 mm max height

TO-92

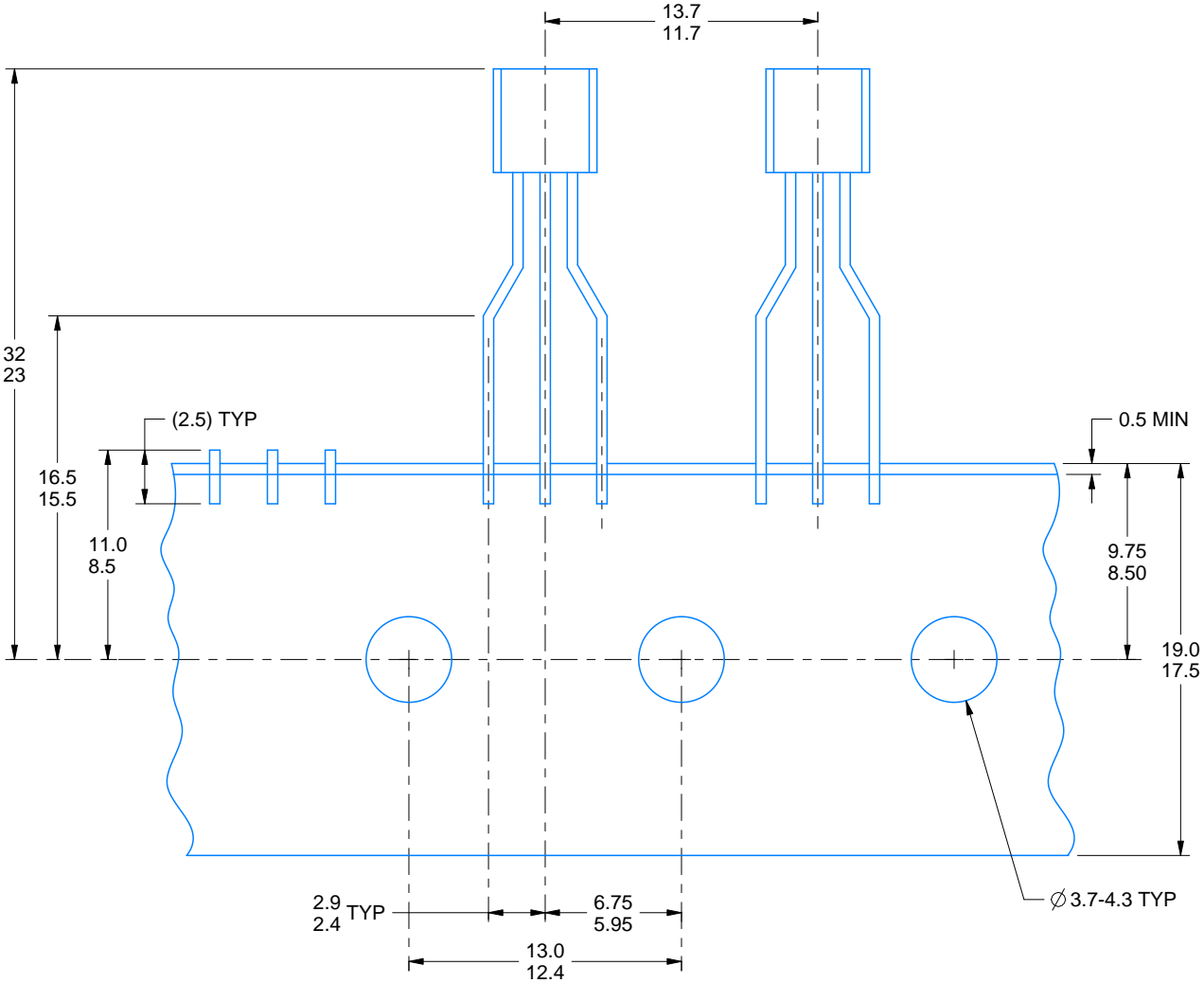

FOR FORMED LEAD OPTION PACKAGE

4215214/B 04/2017

DCK (R-PDSO-G5)

PLASTIC SMALL-OUTLINE PACKAGE

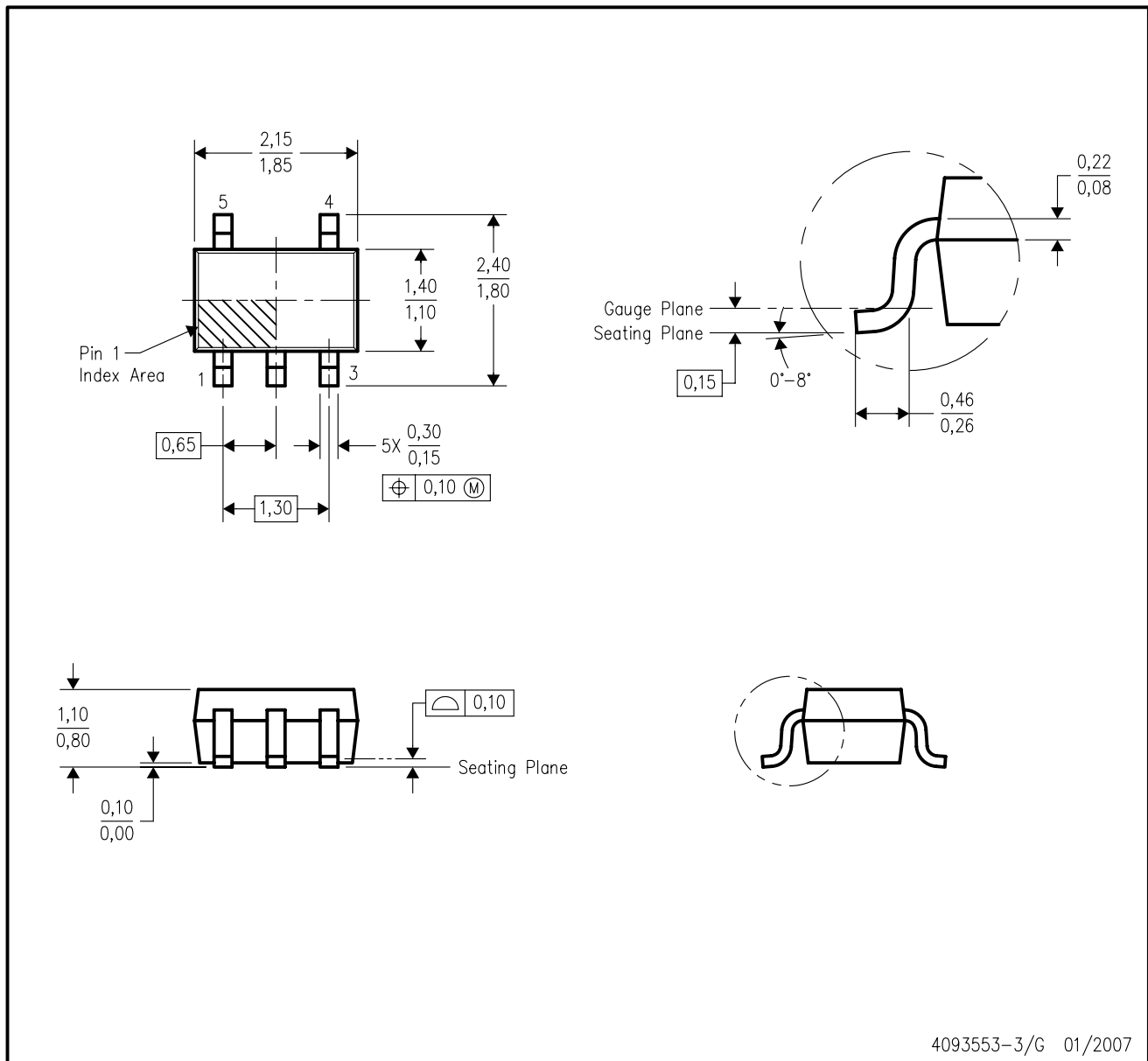

- NOTES:
- A. All linear dimensions are in millimeters.
 - B. This drawing is subject to change without notice.
 - C. Body dimensions do not include mold flash or protrusion. Mold flash and protrusion shall not exceed 0.15 per side.
 - D. Falls within JEDEC MO-203 variation AA.

DCK (R-PDSO-G5)

PLASTIC SMALL OUTLINE



- NOTES:
- All linear dimensions are in millimeters.
 - This drawing is subject to change without notice.
 - Customers should place a note on the circuit board fabrication drawing not to alter the center solder mask defined pad.
 - Publication IPC-7351 is recommended for alternate designs.
 - Laser cutting apertures with trapezoidal walls and also rounding corners will offer better paste release. Customers should contact their board assembly site for stencil design recommendations. Example stencil design based on a 50% volumetric metal load solder paste. Refer to IPC-7525 for other stencil recommendations.

IMPORTANT NOTICE

Texas Instruments Incorporated (TI) reserves the right to make corrections, enhancements, improvements and other changes to its semiconductor products and services per JESD46, latest issue, and to discontinue any product or service per JESD48, latest issue. Buyers should obtain the latest relevant information before placing orders and should verify that such information is current and complete.

TI's published terms of sale for semiconductor products (<http://www.ti.com/sc/docs/stdterms.htm>) apply to the sale of packaged integrated circuit products that TI has qualified and released to market. Additional terms may apply to the use or sale of other types of TI products and services.

Reproduction of significant portions of TI information in TI data sheets is permissible only if reproduction is without alteration and is accompanied by all associated warranties, conditions, limitations, and notices. TI is not responsible or liable for such reproduced documentation. Information of third parties may be subject to additional restrictions. Resale of TI products or services with statements different from or beyond the parameters stated by TI for that product or service voids all express and any implied warranties for the associated TI product or service and is an unfair and deceptive business practice. TI is not responsible or liable for any such statements.

Buyers and others who are developing systems that incorporate TI products (collectively, "Designers") understand and agree that Designers remain responsible for using their independent analysis, evaluation and judgment in designing their applications and that Designers have full and exclusive responsibility to assure the safety of Designers' applications and compliance of their applications (and of all TI products used in or for Designers' applications) with all applicable regulations, laws and other applicable requirements. Designer represents that, with respect to their applications, Designer has all the necessary expertise to create and implement safeguards that (1) anticipate dangerous consequences of failures, (2) monitor failures and their consequences, and (3) lessen the likelihood of failures that might cause harm and take appropriate actions. Designer agrees that prior to using or distributing any applications that include TI products, Designer will thoroughly test such applications and the functionality of such TI products as used in such applications.

TI's provision of technical, application or other design advice, quality characterization, reliability data or other services or information, including, but not limited to, reference designs and materials relating to evaluation modules, (collectively, "TI Resources") are intended to assist designers who are developing applications that incorporate TI products; by downloading, accessing or using TI Resources in any way, Designer (individually or, if Designer is acting on behalf of a company, Designer's company) agrees to use any particular TI Resource solely for this purpose and subject to the terms of this Notice.

TI's provision of TI Resources does not expand or otherwise alter TI's applicable published warranties or warranty disclaimers for TI products, and no additional obligations or liabilities arise from TI providing such TI Resources. TI reserves the right to make corrections, enhancements, improvements and other changes to its TI Resources. TI has not conducted any testing other than that specifically described in the published documentation for a particular TI Resource.

Designer is authorized to use, copy and modify any individual TI Resource only in connection with the development of applications that include the TI product(s) identified in such TI Resource. NO OTHER LICENSE, EXPRESS OR IMPLIED, BY ESTOPPEL OR OTHERWISE TO ANY OTHER TI INTELLECTUAL PROPERTY RIGHT, AND NO LICENSE TO ANY TECHNOLOGY OR INTELLECTUAL PROPERTY RIGHT OF TI OR ANY THIRD PARTY IS GRANTED HEREIN, including but not limited to any patent right, copyright, mask work right, or other intellectual property right relating to any combination, machine, or process in which TI products or services are used. Information regarding or referencing third-party products or services does not constitute a license to use such products or services, or a warranty or endorsement thereof. Use of TI Resources may require a license from a third party under the patents or other intellectual property of the third party, or a license from TI under the patents or other intellectual property of TI.

TI RESOURCES ARE PROVIDED "AS IS" AND WITH ALL FAULTS. TI DISCLAIMS ALL OTHER WARRANTIES OR REPRESENTATIONS, EXPRESS OR IMPLIED, REGARDING RESOURCES OR USE THEREOF, INCLUDING BUT NOT LIMITED TO ACCURACY OR COMPLETENESS, TITLE, ANY EPIDEMIC FAILURE WARRANTY AND ANY IMPLIED WARRANTIES OF MERCHANTABILITY, FITNESS FOR A PARTICULAR PURPOSE, AND NON-INFRINGEMENT OF ANY THIRD PARTY INTELLECTUAL PROPERTY RIGHTS. TI SHALL NOT BE LIABLE FOR AND SHALL NOT DEFEND OR INDEMNIFY DESIGNER AGAINST ANY CLAIM, INCLUDING BUT NOT LIMITED TO ANY INFRINGEMENT CLAIM THAT RELATES TO OR IS BASED ON ANY COMBINATION OF PRODUCTS EVEN IF DESCRIBED IN TI RESOURCES OR OTHERWISE. IN NO EVENT SHALL TI BE LIABLE FOR ANY ACTUAL, DIRECT, SPECIAL, COLLATERAL, INDIRECT, PUNITIVE, INCIDENTAL, CONSEQUENTIAL OR EXEMPLARY DAMAGES IN CONNECTION WITH OR ARISING OUT OF TI RESOURCES OR USE THEREOF, AND REGARDLESS OF WHETHER TI HAS BEEN ADVISED OF THE POSSIBILITY OF SUCH DAMAGES.

Unless TI has explicitly designated an individual product as meeting the requirements of a particular industry standard (e.g., ISO/TS 16949 and ISO 26262), TI is not responsible for any failure to meet such industry standard requirements.

Where TI specifically promotes products as facilitating functional safety or as compliant with industry functional safety standards, such products are intended to help enable customers to design and create their own applications that meet applicable functional safety standards and requirements. Using products in an application does not by itself establish any safety features in the application. Designers must ensure compliance with safety-related requirements and standards applicable to their applications. Designer may not use any TI products in life-critical medical equipment unless authorized officers of the parties have executed a special contract specifically governing such use. Life-critical medical equipment is medical equipment where failure of such equipment would cause serious bodily injury or death (e.g., life support, pacemakers, defibrillators, heart pumps, neurostimulators, and implantables). Such equipment includes, without limitation, all medical devices identified by the U.S. Food and Drug Administration as Class III devices and equivalent classifications outside the U.S.

TI may expressly designate certain products as completing a particular qualification (e.g., Q100, Military Grade, or Enhanced Product). Designers agree that it has the necessary expertise to select the product with the appropriate qualification designation for their applications and that proper product selection is at Designers' own risk. Designers are solely responsible for compliance with all legal and regulatory requirements in connection with such selection.

Designer will fully indemnify TI and its representatives against any damages, costs, losses, and/or liabilities arising out of Designer's non-compliance with the terms and provisions of this Notice.