

## AMC1204 20-MHz, Second-Order, Isolated Delta-Sigma Modulator for Current-Shunt Measurement

### 1 Features

- $\pm 250$ -mV Input Voltage Range Optimized for Shunt Resistors
- Certified Digital Isolation:
  - CSA, VDE V 0884-10, and UL1577 Approved
  - Isolation Voltage: 4250 V<sub>PEAK</sub> (AMC1204B)
  - Working Voltage: 1200 V<sub>PEAK</sub>
  - Transient Immunity: 15 kV/ $\mu$ s
- Long Isolation Barrier Lifetime (see Application Report [SLLA197](#))
- High Electromagnetic Field Immunity (see Application Note [SLLA181A](#))
- Outstanding AC Performance:
  - SNR: 84 dB (Minimum)
  - THD: –80 dB (Maximum)
- Excellent DC Precision:
  - INL:  $\pm 8$ LSB (Maximum)
  - Gain Error:  $\pm 2\%$  (Maximum)
- External Clock Input for Easier Synchronization
- Fully Specified Over the Extended Industrial Temperature Range

### 2 Applications

- Shunt Resistor Based Current Sensing in:
  - Motor Control
  - Green Energy
  - Inverter Applications
  - Uninterruptible Power Supplies

### 3 Description

The AMC1204 and AMC1204B are 1-bit digital output, isolated delta-sigma ( $\Delta\Sigma$ ) modulators that can be clocked at up to 20 MHz. The digital isolation of the modulator output is provided by a silicon dioxide (SiO<sub>2</sub>) barrier that is highly resistant to magnetic interference. This barrier has been certified to provide basic galvanic isolation of up to 4000 V<sub>PEAK</sub> (AMC1204) and 4250 V<sub>PEAK</sub> (AMC1204B) according to UL1577, VDE V 0884-10, and CSA standards or specifications.

The AMC1204 and AMC1204B provide a single-chip solution for measuring the small signal of a shunt resistor across an isolated barrier. These types of resistors are typically used to sense currents in motor control inverters, green energy generation systems, and other industrial applications. The AMC1204 and AMC1204B differential inputs easily connect to the shunt resistor or other low-level signal sources. An internal reference eliminates the need for external components. When used with an appropriate external digital filter, an effective number of bits (ENOB) of 14 is achieved at a data rate of 78 kSPS.

A 5-V analog supply (AVDD) is used by the modulator while the isolated digital interface operates from a 3-V, 3.3-V, or 5-V supply (DVDD). The AMC1204 and AMC1204B are available in SOIC-16 (DW) and SOIC-8 (DWV) packages and are specified from –40°C to 105°C.

#### Device Information<sup>(1)</sup>

PART NUMBER	PACKAGE	BODY SIZE (NOM)
AMC1204	SOIC (16)	10.30 mm x 7.50 mm
	SOIC (8)	5.85 mm x 7.50 mm

(1) For all available packages, see the orderable addendum at the end of the data sheet.

#### Simplified Schematic

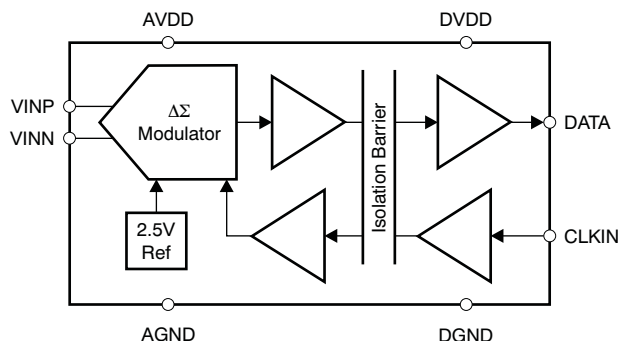

## Table of Contents

<b>1 Features</b> .....	<b>1</b>	7.1 Overview .....	<b>17</b>
<b>2 Applications</b> .....	<b>1</b>	7.2 Functional Block Diagram .....	<b>17</b>
<b>3 Description</b> .....	<b>1</b>	7.3 Feature Description .....	<b>17</b>
<b>4 Revision History</b> .....	<b>2</b>	7.4 Device Functional Modes .....	<b>19</b>
<b>5 Pin Configurations</b> .....	<b>4</b>	<b>8 Application and Implementation</b> .....	<b>20</b>
<b>6 Specifications</b> .....	<b>5</b>	8.1 Application Information .....	<b>20</b>
6.1 Absolute Maximum Ratings .....	<b>5</b>	8.2 Typical Application .....	<b>22</b>
6.2 ESD Ratings .....	<b>5</b>	<b>9 Power Supply Recommendations</b> .....	<b>25</b>
6.3 Recommended Operating Conditions .....	<b>5</b>	<b>10 Layout</b> .....	<b>26</b>
6.4 Thermal Information .....	<b>5</b>	10.1 Layout Guidelines .....	<b>26</b>
6.5 Electrical Characteristics .....	<b>6</b>	10.2 Layout Example .....	<b>26</b>
6.6 Timing Requirements .....	<b>7</b>	<b>11 Device and Documentation Support</b> .....	<b>27</b>
6.7 Regulatory Information .....	<b>7</b>	11.1 Documentation Support .....	<b>27</b>
6.8 IEC Safety Limiting Values .....	<b>8</b>	11.2 Related Links .....	<b>27</b>
6.9 IEC 61000-4-5 Ratings .....	<b>8</b>	11.3 Community Resources .....	<b>27</b>
6.10 IEC 60664-1 Ratings .....	<b>8</b>	11.4 Trademarks .....	<b>27</b>
6.11 Isolation Characteristics .....	<b>9</b>	11.5 Electrostatic Discharge Caution .....	<b>27</b>
6.12 Package Characteristics .....	<b>9</b>	11.6 Glossary .....	<b>27</b>
6.13 Typical Characteristics .....	<b>10</b>	<b>12 Mechanical, Packaging, and Orderable Information</b> .....	<b>27</b>
<b>7 Detailed Description</b> .....	<b>17</b>		

## 4 Revision History

NOTE: Page numbers for previous revisions may differ from page numbers in the current version.

<b>Changes from Revision D (December 2013) to Revision E</b>	<b>Page</b>
• Added <i>ESD Ratings</i> table, <i>Feature Description</i> section, <i>Device Functional Modes</i> , <i>Application and Implementation</i> section, <i>Power Supply Recommendations</i> section, <i>Layout</i> section, <i>Device and Documentation Support</i> section, and <i>Mechanical, Packaging, and Orderable Information</i> section .....	<b>1</b>
• Changed first sub-bullet of <i>Certified Digital Isolation</i> Feature bullet: changed IEC60747-5-5 to VDE V 0884-10 .....	<b>1</b>
• Changed IEC60747-5-5 to VDE V 0884-10 in first paragraph of <i>Description</i> section .....	<b>1</b>
• Changed Isolator to Package in title of <i>Isolator Characteristics</i> table .....	<b>2</b>
• Changed IEC60747-5-5 to VDE V 0884-10 in first row of <i>Regulatory Information</i> table .....	<b>7</b>
• Changed Isolator to Package in title of <i>Isolator Characteristics</i> table .....	<b>9</b>
• Changed Isolator to Package in title of <i>Isolator Characteristics</i> table .....	<b>26</b>

<b>Changes from Revision C (August 2012) to Revision D</b>	<b>Page</b>
• Changed first sub-bullet of <i>Certified Digital Isolation</i> Feature bullet: changed IEC60747-5-2 to IEC60747-5-5 .....	<b>1</b>
• Deleted chip photo .....	<b>1</b>
• Added DWV (SSO-8) package to document .....	<b>1</b>
• Changed IEC60747-5-2 to IEC60747-5-5 in first paragraph of <i>Description</i> section .....	<b>1</b>
• Changed last paragraph of <i>Description</i> section .....	<b>1</b>
• Added DWV pin out drawing .....	<b>4</b>
• Added DWV information to <i>Pin Descriptions</i> table .....	<b>4</b>
• Added DWV package to <i>Thermal Information</i> table .....	<b>5</b>
• Changed IEC60747-5-2 to IEC60747-5-5 in first row of <i>Regulatory Information</i> table .....	<b>7</b>
• Added DWV package row to <i>L(I01)</i> and <i>L(I02)</i> parameters in <i>Isolator Characteristics</i> table .....	<b>9</b>
• Changed first paragraph of <i>Digital Output</i> section: changed 78.1% to 89.06% and 21.9% to 10.94% .....	<b>19</b>

<b>Changes from Revision B (August 2011) to Revision C</b>	<b>Page</b>
• Changed Certified digital isolation, isolation voltage Feature bullet.....	1
• Added AMC1204B to document.....	1
• Changed Description section to include AMC1204B.....	1
• Changed package name from TSSOP to SO.....	4
• Changed footnote 1 in <i>Electrical Characteristics</i> table.....	6
• Changed Analog Inputs, $V_{CM}$ parameter minimum specification and unit in <i>Electrical Characteristics</i> table.....	6
• Changed Digital Output, $C_{OUT}$ and $C_{LOAD}$ parameters unit specifications in <i>Electrical Characteristics</i> table.....	7
• Added AMC1204B values to Isolation Characteristics table.....	9
• Changed AMC1204 $V_{IOTM}$ t = 1s value in Isolation Characteristics table.....	9
• Changed CTI minimum specification in Isolator Characteristics table.....	9
• Updated <a href="#">Figure 51</a> .....	24
• Updated <a href="#">Figure 53</a> .....	25
• Updated <a href="#">Figure 54</a> .....	26

---

<b>Changes from Revision A (April 2011) to Revision B</b>	<b>Page</b>
• Changed value of $V_{IOSM}$ parameter in IEC 61000-4-5 Ratings table.....	8

---

## 5 Pin Configurations

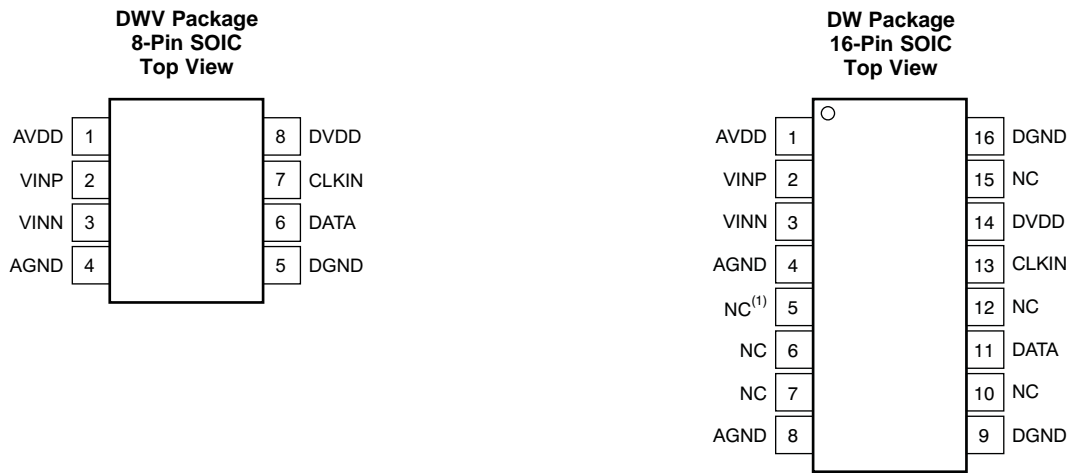

NC = no internal connection.

### Pin Functions

NAME	PIN NO.		I/O	DESCRIPTION
	NO.			
	8 PINS	16 PINS		
AVDD	1	1	Power	High-side power supply
VINP	2	2	Analog input	Noninverting analog input
VINN	3	3	Analog input	Inverting analog input
AGND	4	4, 8 <sup>(1)</sup>	Power	High-side ground
DGND	5	9, 16	Power	Controller-side ground
DATA	6	11	Digital output	Modulator data output
CLKIN	7	13	Digital input	Modulator clock input
DVDD	8	14	Power	Controller-side power supply
NC	—	5-7, 10, 12, 15	—	No internal connection; can be tied to any potential or left unconnected

(1) Both pins are connected internally via a low-impedance path; thus, only one of the pins must be tied to the ground plane.

## 6 Specifications

### 6.1 Absolute Maximum Ratings

Over the operating ambient temperature range, unless otherwise noted. <sup>(1)</sup>

	MIN	MAX	UNIT
Supply voltage, AVDD to AGND or DVDD to DGND	-0.3	6	V
Analog input voltage at VINP, VINN	AGND - 0.5	AVDD + 0.5	V
Digital input voltage at CLKIN	DGND - 0.3	DVDD + 0.3	V
Input current to any pin except supply pins	-10	10	mA
Maximum virtual junction temperature, T <sub>J</sub>		150	°C
Operating ambient temperature, T <sub>OA</sub>	-40	125	°C
Storage temperature, T <sub>stg</sub>	-65	150	°C

- (1) Stresses beyond those listed under absolute maximum ratings may cause permanent damage to the device. These are stress ratings only, and functional operation of the device at these or any other conditions beyond those indicated under the [Electrical Characteristics](#) is not implied. Exposure to absolute maximum rated conditions for extended periods may affect device reliability.

### 6.2 ESD Ratings

		VALUE	UNIT
V <sub>(ESD)</sub> Electrostatic discharge	Human-body model (HBM), per JEDEC standard 22, test method A114-C.01 <sup>(1)</sup>	±3000	V
	Charged-device model (CDM), per JEDEC standard 22, test method C101 <sup>(2)</sup>	±1500	
	Machine model (MM), per JEDEC standard 22, test method A115A	±200	

- (1) JEDEC document JEP155 states that 500-V HBM allows safe manufacturing with a standard ESD control process.  
 (2) JEDEC document JEP157 states that 250-V CDM allows safe manufacturing with a standard ESD control process.

### 6.3 Recommended Operating Conditions

over operating free-air temperature range (unless otherwise noted)

	MIN	NOM	MAX	UNIT
T <sub>A</sub> Operating ambient temperature	-40		105	°C
AVDD High-side (analog) supply voltage	4.5	5	5.5	V
DVDD Controller-side (digital) supply voltage	2.7	3.3	5.5	V

### 6.4 Thermal Information

THERMAL METRIC <sup>(1)</sup>		AMC1204, AMC1204B		UNIT
		DW (SOIC)	DWV (SOIC)	
		16 PINS	8 PINS	
R <sub>θJA</sub>	Junction-to-ambient thermal resistance	78.5	106.5	°C/W
R <sub>θJC(top)</sub>	Junction-to-case (top) thermal resistance	41.3	53.6	°C/W
R <sub>θJB</sub>	Junction-to-board thermal resistance	50.2	60.3	°C/W
ψ <sub>JT</sub>	Junction-to-top characterization parameter	11.5	18.5	°C/W
ψ <sub>JB</sub>	Junction-to-board characterization parameter	41.2	58.9	°C/W
R <sub>θJC(bot)</sub>	Junction-to-case (bottom) thermal resistance	n/a	n/a	°C/W

- (1) For more information about traditional and new thermal metrics, see the *Semiconductor and IC Package Thermal Metrics* application report, [SPRA953](#).

## 6.5 Electrical Characteristics

All minimum/maximum specifications at  $T_A = -40^\circ\text{C}$  to  $105^\circ\text{C}$ ,  $AVDD = 4.5\text{ V}$  to  $5.5\text{ V}$ ,  $DVDD = 2.7\text{ V}$  to  $5.5\text{ V}$ ,  $V_{INP} = -250\text{ mV}$  to  $250\text{ mV}$ ,  $V_{INN} = 0\text{ V}$ , and sinc<sup>3</sup> filter with OSR = 256, unless otherwise noted.

Typical values are at  $T_A = 25^\circ\text{C}$ ,  $AVDD = 5\text{ V}$ , and  $DVDD = 3.3\text{ V}$ .

PARAMETER		TEST CONDITIONS	MIN	TYP	MAX	UNIT
<b>RESOLUTION</b>						
Resolution			16			Bits
<b>DC ACCURACY</b>						
INL	Integral linearity error <sup>(1)</sup>	$T_A = -40^\circ\text{C}$ to $85^\circ\text{C}$	-8	±2	8	LSB
		$T_A = -40^\circ\text{C}$ to $105^\circ\text{C}$	-16	±5	16	LSB
DNL	Differential nonlinearity		-1		1	LSB
$V_{OS}$	Offset error <sup>(2)</sup>		-1	±0.1	1	mV
$TCV_{OS}$	Offset error thermal drift		-3.5	±1	3.5	μV/°C
$G_{ERR}$	Gain error <sup>(2)</sup>		-2%	±0.5%	2%	
$TCG_{ERR}$	Gain error thermal drift			±30		ppm/°C
PSRR	Power-supply rejection ratio			79		dB
<b>ANALOG INPUTS</b>						
FSR	Full-scale differential voltage input range	$V_{INP} - V_{INN}$		±320		mV
		Specified FSR	-250		250	mV
$V_{CM}$	Operating common-mode signal <sup>(3)</sup>		-160		$AVDD$	mV
$C_I$	Input capacitance to AGND	$V_{INP}$ or $V_{INN}$		7		pF
$C_{ID}$	Differential input capacitance			3.5		pF
$R_{ID}$	Differential input resistance			12.5		kΩ
$I_{IL}$	Input leakage current	$V_{INP} - V_{INN} = \pm 250\text{ mV}$	-10		10	μA
		$V_{INP} - V_{INN} = \pm 320\text{ mV}$	-50		50	μA
CMTI	Common-mode transient immunity		15			kV/μs
CMRR	Common-mode rejection ratio	$V_{IN}$ from 0 V to 5 V at 0 Hz		108		dB
		$V_{IN}$ from 0 V to 5 V at 100 kHz		114		dB
<b>EXTERNAL CLOCK</b>						
$t_{CLKIN}$	Clock period		45.5	50	200	ns
$f_{CLKIN}$	Input clock frequency		5	20	22	MHz
Duty <sub>CLKIN</sub>	Duty cycle	$5\text{ MHz} \leq f_{CLKIN} < 20\text{ MHz}$	40%	50%	60%	
		$20\text{ MHz} \leq f_{CLKIN} \leq 22\text{ MHz}$	45%	50%	55%	
<b>AC ACCURACY</b>						
SINAD	Signal-to-noise + distortion	$f_{IN} = 1\text{ kHz}$ , $T_A = -40^\circ\text{C}$ to $85^\circ\text{C}$	78	87		dB
		$f_{IN} = 1\text{ kHz}$ , $T_A = -40^\circ\text{C}$ to $105^\circ\text{C}$	70	87		dB
SNR	Signal-to-noise ratio	$f_{IN} = 1\text{ kHz}$ , $T_A = -40^\circ\text{C}$ to $85^\circ\text{C}$	84	88		dB
		$f_{IN} = 1\text{ kHz}$ , $T_A = -40^\circ\text{C}$ to $105^\circ\text{C}$	83	88		dB
THD	Total harmonic distortion	$f_{IN} = 1\text{ kHz}$ , $T_A = -40^\circ\text{C}$ to $85^\circ\text{C}$		-96	-80	dB
		$f_{IN} = 1\text{ kHz}$ , $T_A = -40^\circ\text{C}$ to $105^\circ\text{C}$		-96	-70	dB
SFDR	Spurious-free dynamic range	$f_{IN} = 1\text{ kHz}$ , $T_A = -40^\circ\text{C}$ to $85^\circ\text{C}$	82	96		dB
		$f_{IN} = 1\text{ kHz}$ , $T_A = -40^\circ\text{C}$ to $105^\circ\text{C}$	72	96		dB
<b>DIGITAL INPUTS<sup>(3)</sup></b>						
$I_{IN}$	Input current	$V_{IN} = DVDD$ to DGND	-10		10	μA
$C_{IN}$	Input capacitance			5		pF
<b>CMOS logic family</b>						
CMOS with Schmitt-trigger						
$V_{IH}$	High-level input voltage	$DVDD = 4.5\text{ V}$ to $5.5\text{ V}$	$0.7DVDD$		$DVDD + 0.3$	V
$V_{IL}$	Low-level input voltage	$DVDD = 4.5\text{ V}$ to $5.5\text{ V}$	-0.3		$0.3DVDD$	V
<b>LVC MOS logic family</b>						
LVC MOS						
$V_{IH}$	High-level input voltage	$DVDD = 2.7\text{ V}$ to $3.6\text{ V}$	2		$DVDD + 0.3$	V

(1) Integral nonlinearity is defined as the maximum deviation from a straight line passing through the end-points of the ideal ADC transfer function expressed as number of LSBs or as a percent of the specified 500-mV input range.

(2) Maximum values, including temperature drift, are ensured over the full specified temperature range.

(3) Ensured by design.

## Electrical Characteristics (continued)

All minimum/maximum specifications at  $T_A = -40^\circ\text{C}$  to  $105^\circ\text{C}$ ,  $AVDD = 4.5\text{ V}$  to  $5.5\text{ V}$ ,  $DVDD = 2.7\text{ V}$  to  $5.5\text{ V}$ ,  $V_{INP} = -250\text{ mV}$  to  $250\text{ mV}$ ,  $V_{INN} = 0\text{ V}$ , and sinc<sup>3</sup> filter with  $OSR = 256$ , unless otherwise noted.

Typical values are at  $T_A = 25^\circ\text{C}$ ,  $AVDD = 5\text{ V}$ , and  $DVDD = 3.3\text{ V}$ .

PARAMETER	TEST CONDITIONS	MIN	TYP	MAX	UNIT
$V_{IL}$ Low-level input voltage	$DVDD = 2.7\text{ V}$ to $3.6\text{ V}$	-0.3		0.8	V
<b>DIGITAL OUTPUTS<sup>(3)</sup></b>					
$C_{OUT}$ Output capacitance			5		pF
$C_{LOAD}$ Load capacitance				30	pF
<b>CMOS logic family</b>					
$V_{OH}$ High-level output voltage	$DVDD = 4.5\text{ V}$ , $I_{OH} = -100\ \mu\text{A}$	4.4			V
$V_{OL}$ Low-level output voltage	$DVDD = 4.5\text{ V}$ , $I_{OL} = 100\ \mu\text{A}$			0.5	V
<b>LVC MOS logic family</b>					
$V_{OH}$ High-level output voltage	$I_{OH} = 20\ \mu\text{A}$	$DVDD - 0.1$			V
	$I_{OH} = -4\text{ mA}$ , $2.7\text{ V} \leq DVDD \leq 3.6\text{ V}$	$DVDD - 0.4$			V
	$I_{OH} = -4\text{ mA}$ , $4.5\text{ V} \leq DVDD \leq 5.5\text{ V}$	$DVDD - 0.8$			V
$V_{OL}$ Low-level output voltage	$I_{OL} = 20\ \mu\text{A}$			0.1	V
	$I_{OL} = 4\text{ mA}$			0.4	V
<b>POWER SUPPLY</b>					
$AVDD$ High-side supply voltage		4.5	5	5.5	V
$DVDD$ Controller-side supply voltage		2.7	3.3	5.5	V
$I_{AVDD}$ High-side supply current	$4.5\text{ V} \leq AVDD \leq 5.5\text{ V}$		11	16	mA
$I_{DVDD}$ Controller-side supply current	$2.7\text{ V} \leq DVDD \leq 3.6\text{ V}$		2	4	mA
	$4.5\text{ V} \leq DVDD \leq 5.5\text{ V}$		2.8	5	mA
$P_D$ Power dissipation	$AVDD = 5.5\text{ V}$ , $DVDD = 3.6\text{ V}$		61.6	102.4	mW

## 6.6 Timing Requirements

Over recommended ranges of supply voltage and operating free-air temperature, unless otherwise noted. (See [Figure 1](#))

	MIN	NOM	MAX	UNIT
$t_{CLK}$ CLKIN clock period	45.5	50	200	ns
$t_{HIGH}$ CLKIN clock high time	20	25	120	ns
$t_{LOW}$ CLKIN clock low time	20	25	120	ns
$t_D$ Delayed falling edge of CLKIN to DATA valid	2		15	ns

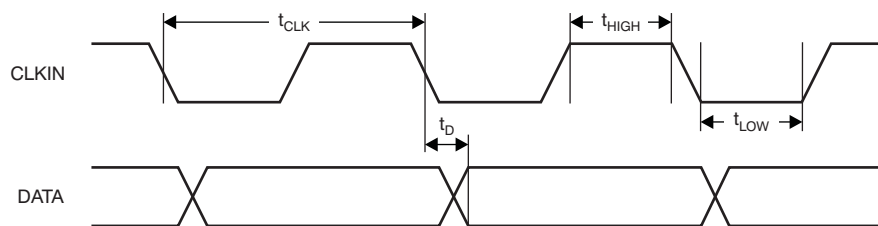

**Figure 1. Modulator Output Timing**

## 6.7 Regulatory Information

VDE/IEC	CSA	UL
Certified according to VDE V 0884-10	Approved under CSA component acceptance notice	Recognized under 1577 component recognition program
Certificate number: 40016131	File number: 2350550	File number: E181974

## 6.8 IEC Safety Limiting Values

Safety limiting intends to prevent potential damage to the isolation barrier upon failure of input or output (I/O) circuitry. A failure of the I/O circuitry can allow low resistance to ground or the supply and, without current limiting, dissipate sufficient power to overheat the die and damage the isolation barrier, potentially leading to secondary system failures.

The safety-limiting constraint is the operating virtual junction temperature range specified in the [Absolute Maximum Ratings](#) table. The power dissipation and junction-to-air thermal impedance of the device installed in the application hardware determine the junction temperature. The assumed junction-to-air thermal resistance in the [Thermal Information](#) table is that of a device installed in the JESD51-3, *Low Effective Thermal Conductivity Test Board for Leaded Surface Mount Packages* and is conservative. The power is the recommended maximum input voltage times the current. The junction temperature is then the ambient temperature plus the power times the junction-to-air thermal resistance.

PARAMETER	TEST CONDITIONS	MIN	TYP	MAX	UNIT
$I_S$ Safety input, output, or supply current	$\theta_{JA} = 78.5^\circ\text{C}/\text{W}$ , $V_I = 5.5\text{ V}$ , $T_J = 150^\circ\text{C}$ , $T_A = 25^\circ\text{C}$			10	mA
$T_C$ Maximum case temperature				150	$^\circ\text{C}$

## 6.9 IEC 61000-4-5 Ratings

PARAMETER	TEST CONDITIONS	VALUE	UNIT
$V_{IOSM}$ Surge immunity	1.2/50- $\mu\text{s}$ voltage surge and 8/20- $\mu\text{s}$ current surge	$\pm 6000$	V

## 6.10 IEC 60664-1 Ratings

PARAMETER	TEST CONDITIONS	SPECIFICATION
Basic isolation group	Material group	II
Installation classification	Rated mains voltage $\leq 150V_{RMS}$	I-IV
	Rated mains voltage $< 300V_{RMS}$	I-IV
	Rated mains voltage $< 400V_{RMS}$	I-III
	Rated mains voltage $< 600V_{RMS}$	I-III



## 6.11 Isolation Characteristics

PARAMETER		TEST CONDITIONS	AMC1204	AMC1204B	UNIT
V <sub>IORM</sub>	Maximum working insulation voltage		1200	1200	V <sub>PEAK</sub>
V <sub>PD(t)</sub>	Partial discharge test voltage	t = 1 s (100% production test), partial discharge < 5 pC	2250	2250	V <sub>PEAK</sub>
V <sub>IOTM</sub>	Transient overvoltage	t = 60 s (qualification test)	4000	4250	V <sub>PEAK</sub>
		t = 1 s (100% production test)	4800	5100	V <sub>PEAK</sub>
R <sub>S</sub>	Isolation resistance	V <sub>IO</sub> = 500 V at T <sub>S</sub>	> 10 <sup>9</sup>	> 10 <sup>9</sup>	Ω
PD	Pollution degree		2	2	Degrees

## 6.12 Package Characteristics

PARAMETER		TEST CONDITIONS <sup>(1)</sup>		MIN	TYP	MAX	UNIT
L(I01)	Minimum air gap (clearance)	Shortest terminal to terminal distance through air	DWV package	8			mm
			DW package	7.9			mm
L(I02)	Minimum external tracking (creepage)	Shortest terminal to terminal distance across the package surface	DWV package	8			mm
			DW package	7.9			mm
CTI	Tracking resistance (comparative tracking index)	DIN IEC 60112/VDE 0303 part 1		> 400			V
	Minimum internal gap (internal clearance)	Distance through the insulation		0.014			mm
R <sub>IO</sub>	Isolation resistance	Input to output, V <sub>IO</sub> = 500 V, all pins on each side of the barrier tied together to create a two-terminal device, T <sub>A</sub> < 85°C			> 10 <sup>12</sup>		Ω
		Input to output, V <sub>IO</sub> = 500 V, 100°C ≤ T <sub>A</sub> < T <sub>A</sub> max			> 10 <sup>11</sup>		Ω
C <sub>IO</sub>	Barrier capacitance input to output	V <sub>I</sub> = 0.8 V <sub>PP</sub> at 1 MHz			1.2		pF
C <sub>I</sub>	Input capacitance to ground	V <sub>I</sub> = 0.8 V <sub>PP</sub> at 1 MHz			3		pF

- (1) Creepage and clearance requirements should be applied according to the specific equipment isolation standards of a specific application. Care should be taken to maintain the creepage and clearance distance of the board design to ensure that the mounting pads of the isolator on the printed circuit board (PCB) do not reduce this distance. Creepage and clearance on a PCB become equal according to the measurement techniques shown in the [TI Isolation Glossary](#). Techniques such as inserting grooves, ribs, or both on the PCB are used to help increase these specifications.

### 6.13 Typical Characteristics

At AVDD = 5 V, DVDD = 3.3 V, VINP = –250 mV to 250 mV, VINN = 0 V, and sinc<sup>3</sup> filter with OSR = 256, unless otherwise noted.

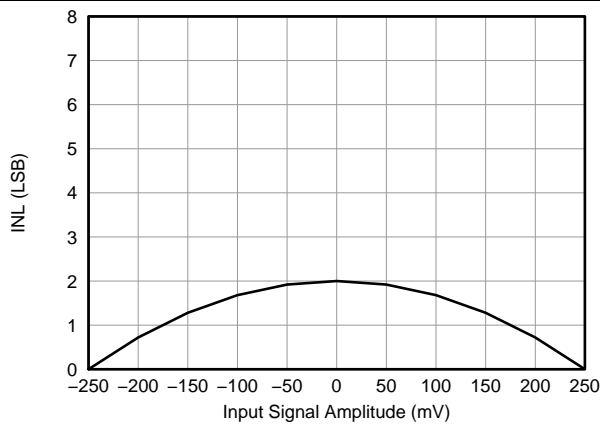

**Figure 2. Integral Nonlinearity vs Input Signal Amplitude**

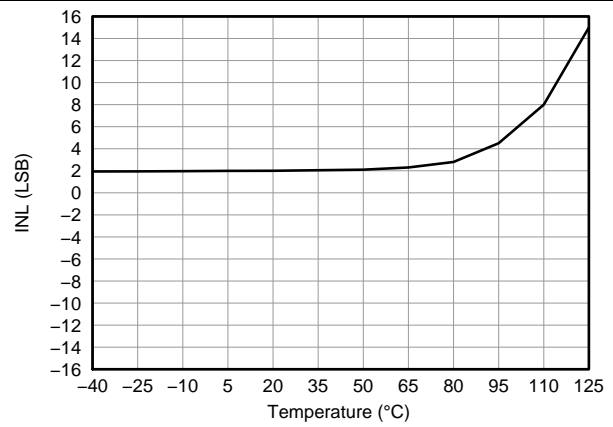

**Figure 3. Integral Nonlinearity vs Temperature**

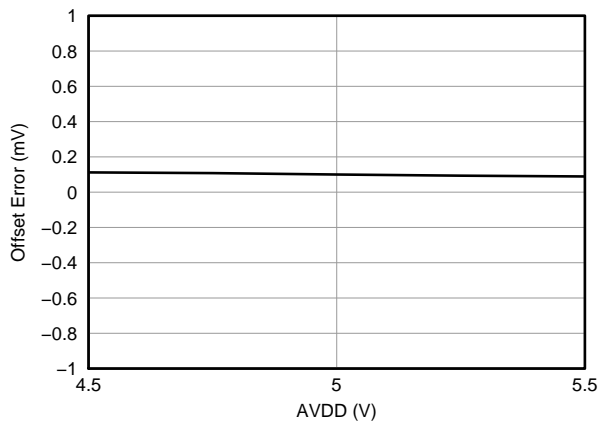

**Figure 4. Offset Error vs Analog Supply Voltage**

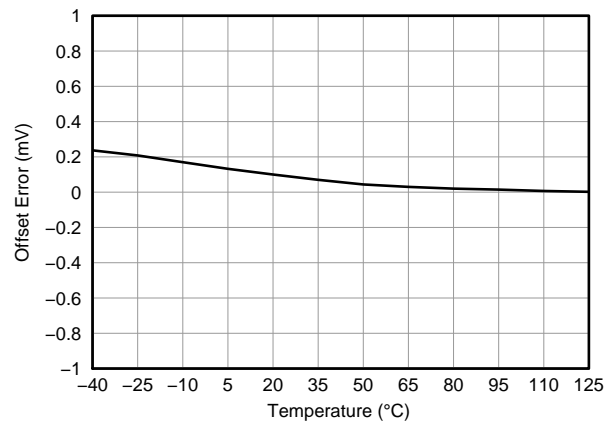

**Figure 5. Offset Error vs Temperature**

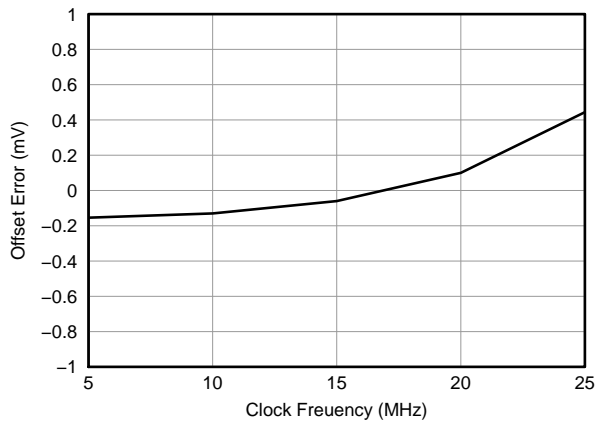

**Figure 6. Offset Error vs Clock Frequency**

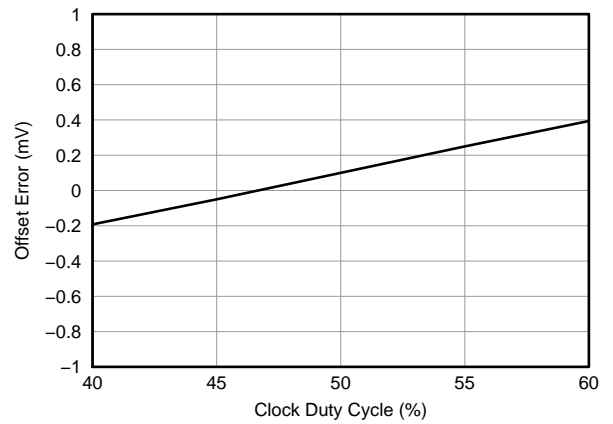

**Figure 7. Offset Error vs Clock Duty Cycle**

**Typical Characteristics (continued)**

At AVDD = 5 V, DVDD = 3.3 V, VINP = –250 mV to 250 mV, VINN = 0 V, and sinc<sup>3</sup> filter with OSR = 256, unless otherwise noted.

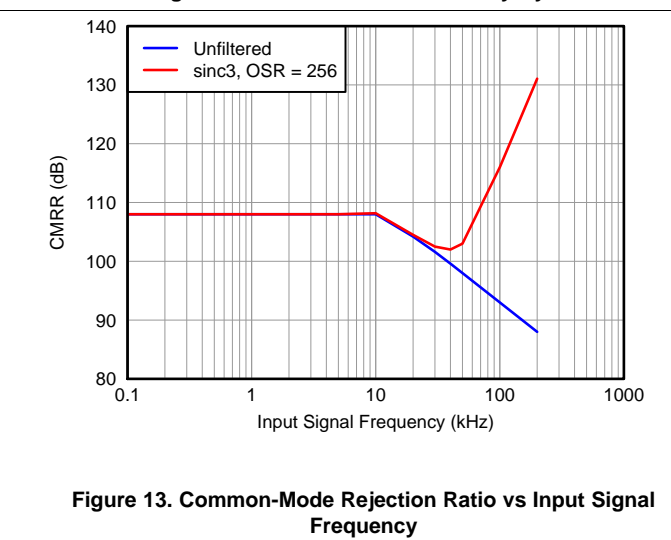
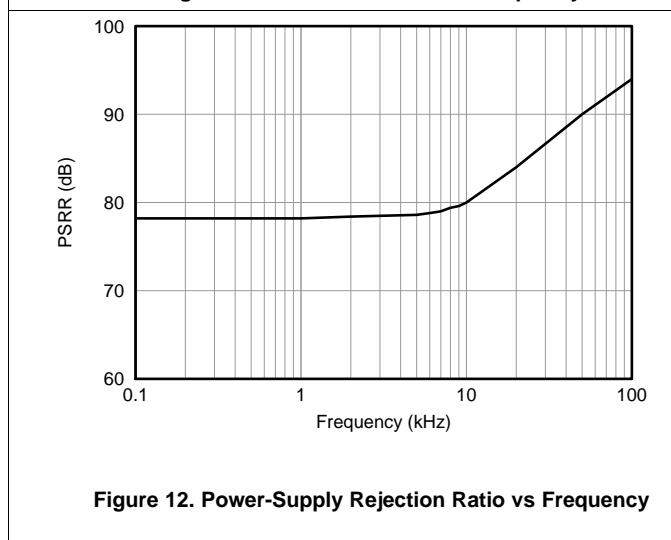
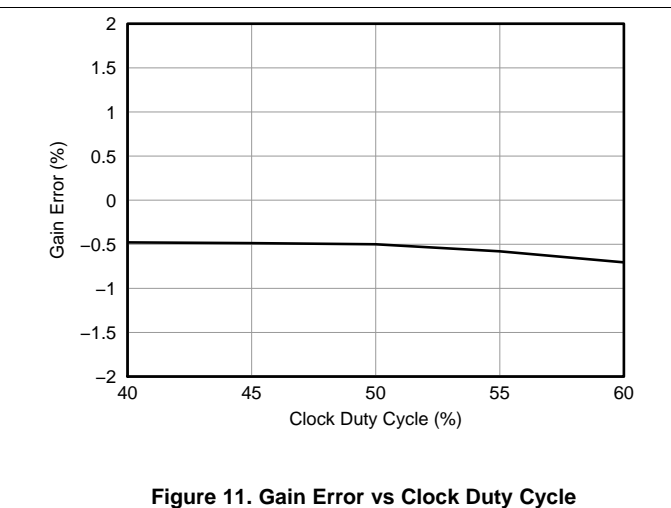
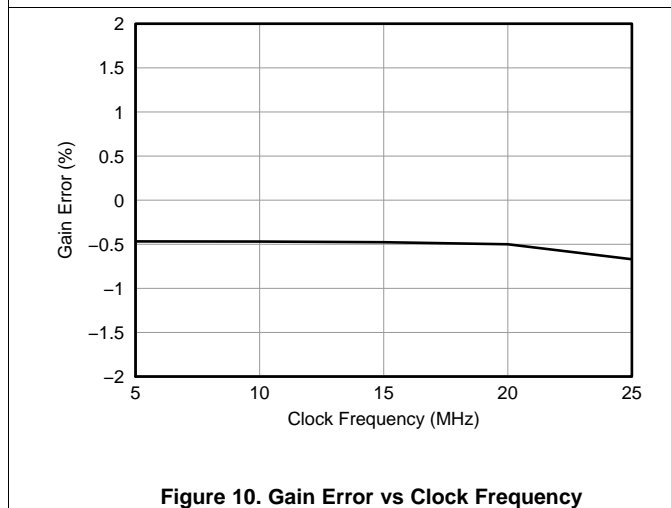
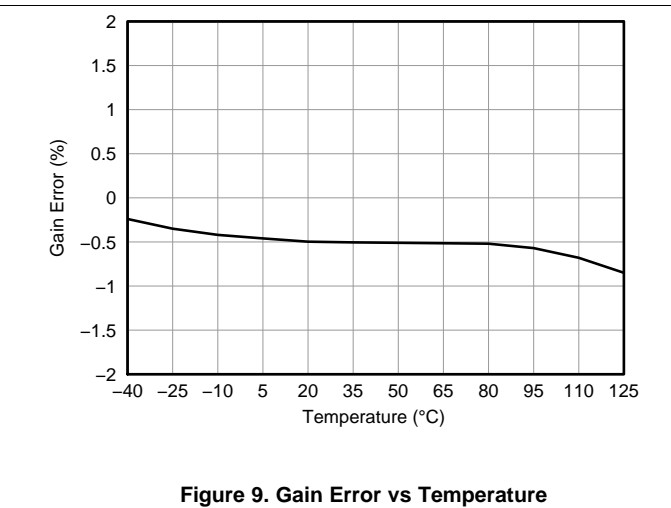
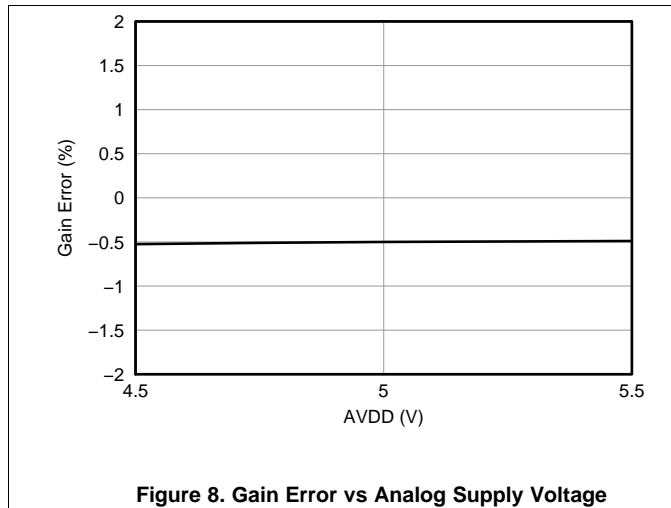

**Typical Characteristics (continued)**

At AVDD = 5 V, DVDD = 3.3 V, VINP = –250 mV to 250 mV, VINN = 0 V, and sinc<sup>3</sup> filter with OSR = 256, unless otherwise noted.

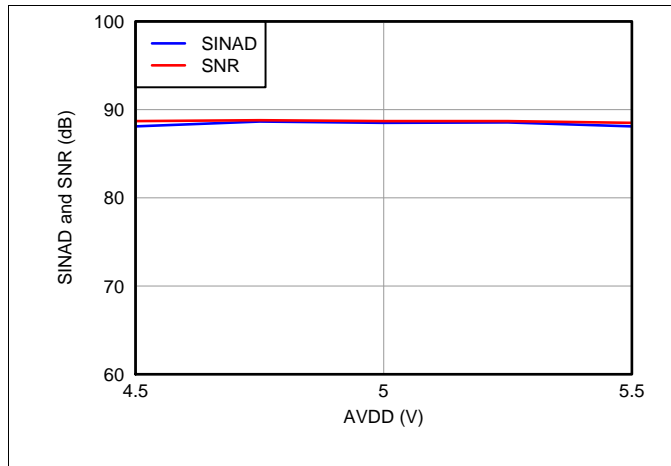

**Figure 14. SINAD and SNR vs Analog Supply Voltage**

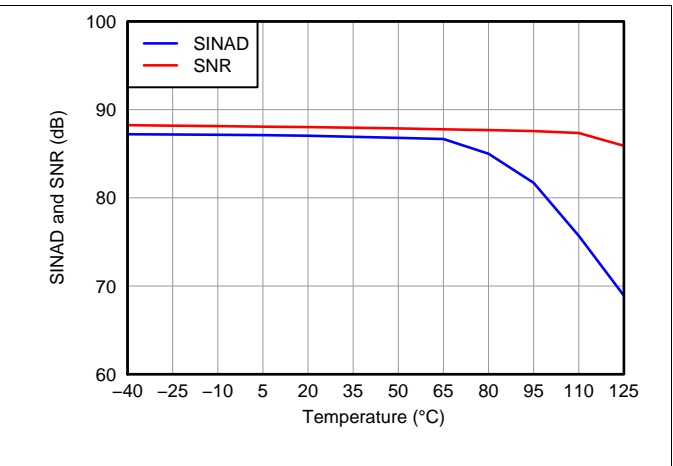

**Figure 15. SINAD and SNR vs Temperature**

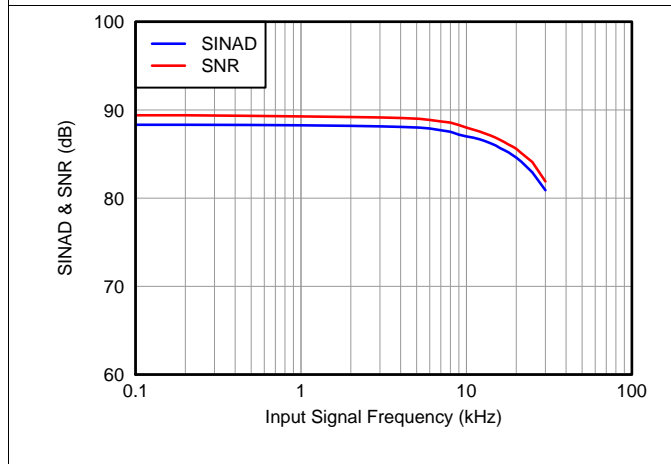

**Figure 16. SINAD and SNR vs Input Signal Frequency**

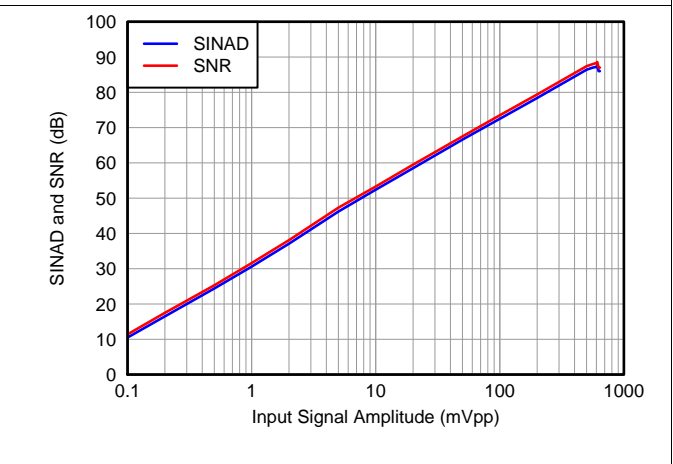

**Figure 17. SINAD and SNR vs Input Signal Amplitude**

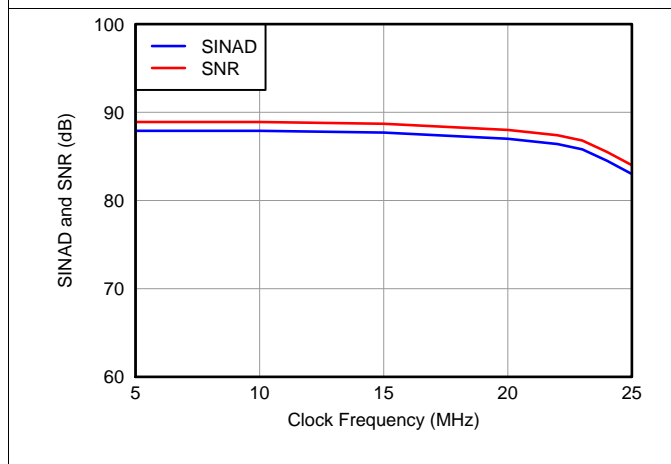

**Figure 18. SINAD and SNR vs Clock Frequency**

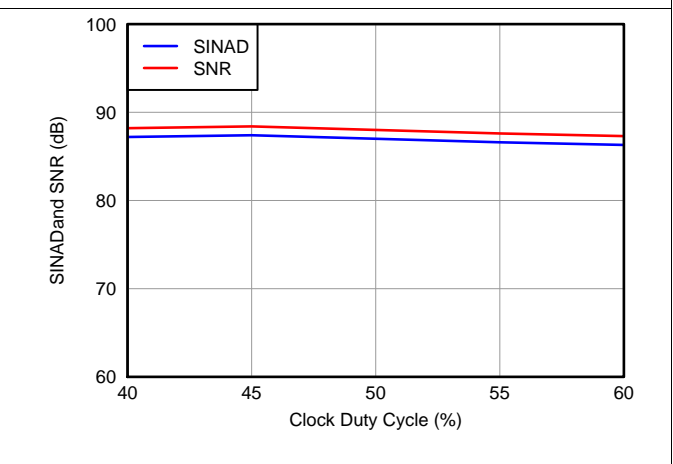

**Figure 19. SINAD and SNR vs Clock Duty Cycle**

**Typical Characteristics (continued)**

At AVDD = 5 V, DVDD = 3.3 V, VINP = –250 mV to 250 mV, VINN = 0 V, and sinc<sup>3</sup> filter with OSR = 256, unless otherwise noted.

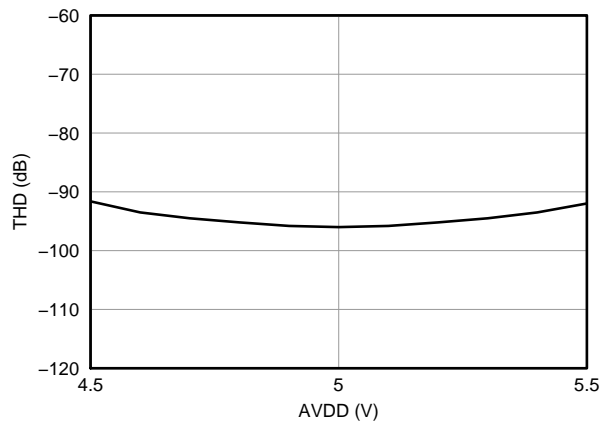

**Figure 20. Total Harmonic Distortion vs Analog Supply Voltage**

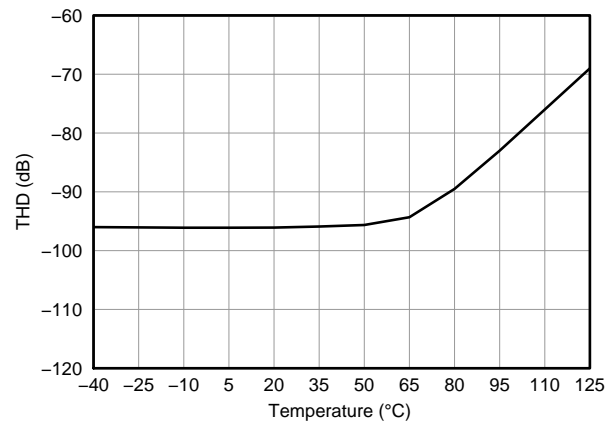

**Figure 21. Total Harmonic Distortion vs Temperature**

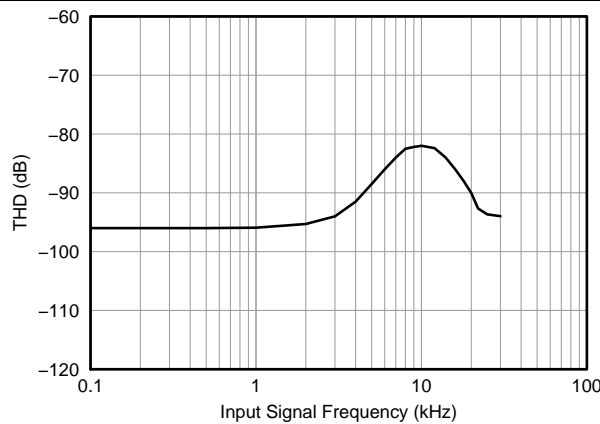

**Figure 22. Total Harmonic Distortion vs Input Signal Frequency**

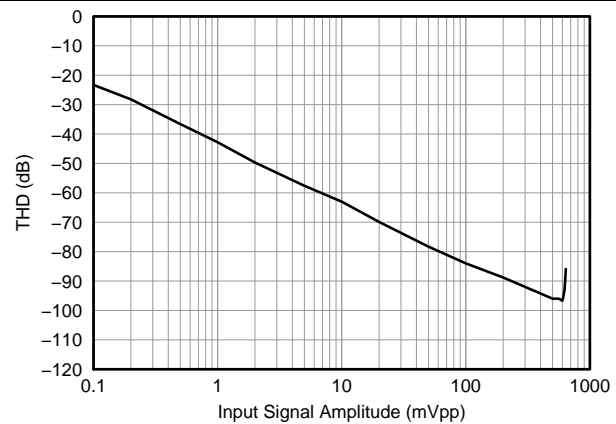

**Figure 23. Total Harmonic Distortion vs Input Signal Amplitude**

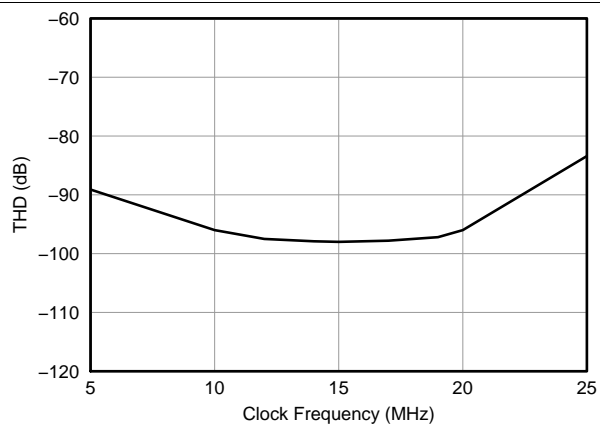

**Figure 24. Total Harmonic Distortion vs Clock Frequency**

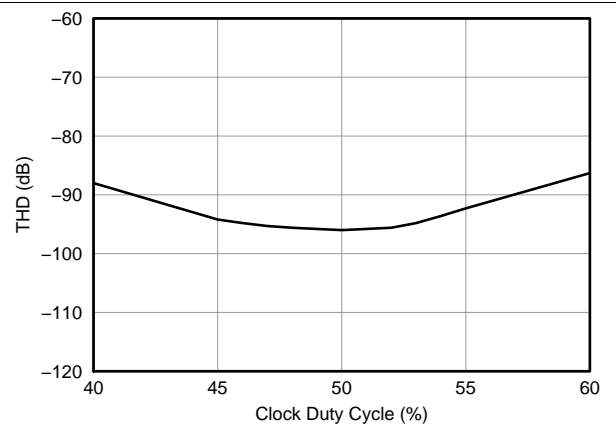

**Figure 25. Total Harmonic Distortion vs Clock Duty Cycle**

Typical Characteristics (continued)

At AVDD = 5 V, DVDD = 3.3 V, VINP = -250 mV to 250 mV, VINN = 0 V, and sinc<sup>3</sup> filter with OSR = 256, unless otherwise noted.

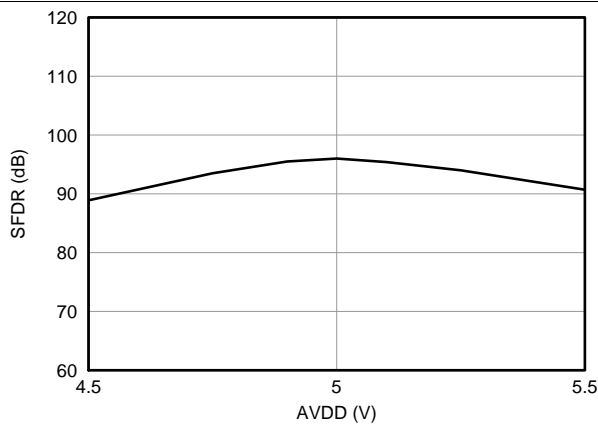

Figure 26. Spurious-Free Dynamic Range vs Analog Supply Voltage

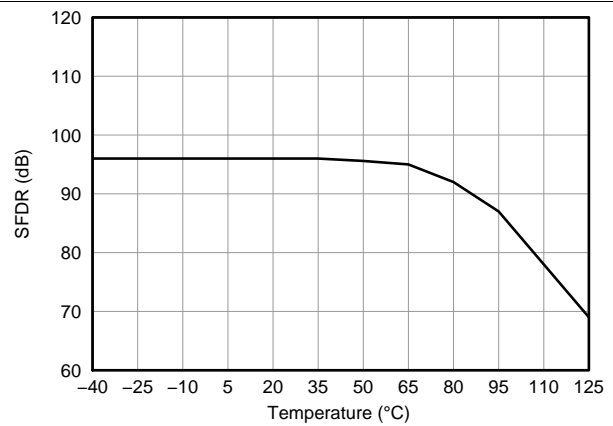

Figure 27. Spurious-Free Dynamic Range vs Temperature

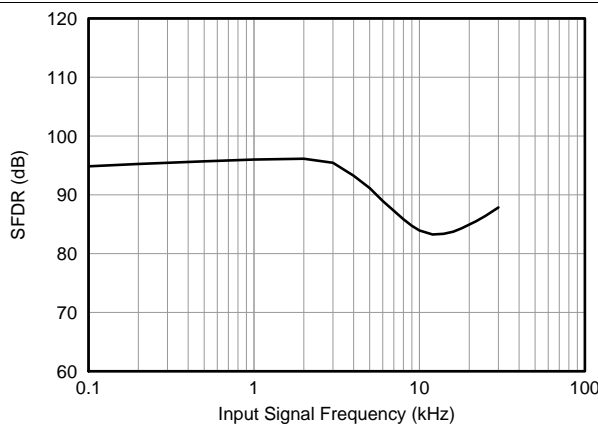

Figure 28. Spurious-Free Dynamic Range vs Input Signal Frequency

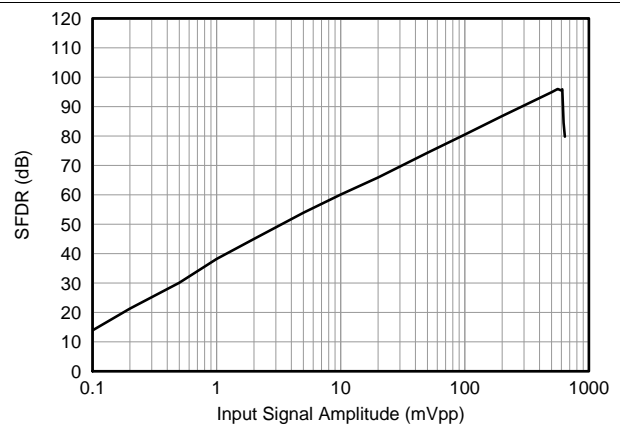

Figure 29. Spurious-Free Dynamic Range vs Input Signal Amplitude

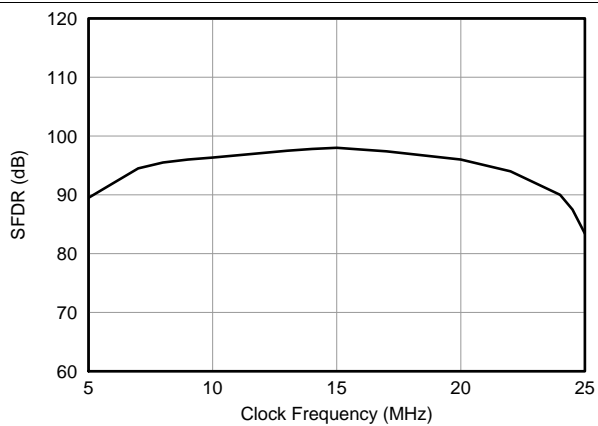

Figure 30. Spurious-Free Dynamic Range vs Clock Frequency

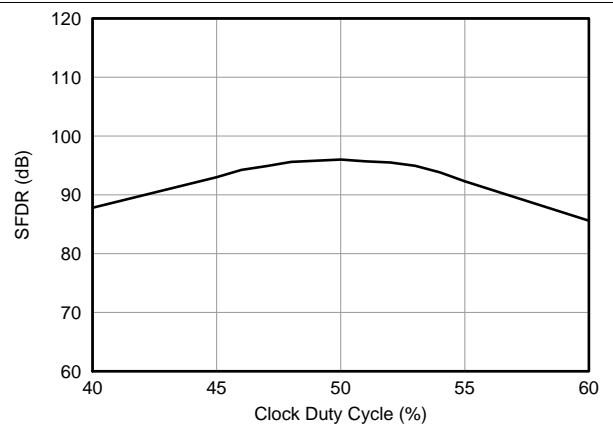

Figure 31. Spurious-Free Dynamic Range vs Clock Duty Cycle

### Typical Characteristics (continued)

At AVDD = 5 V, DVDD = 3.3 V, VINP = –250 mV to 250 mV, VINN = 0 V, and sinc<sup>3</sup> filter with OSR = 256, unless otherwise noted.

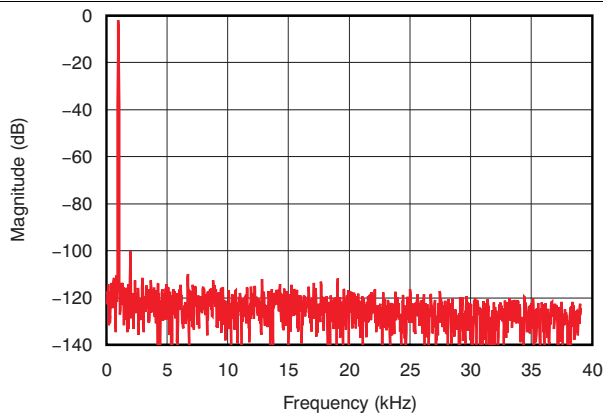

Figure 32. Frequency Spectrum (4096 Point FFT,  $f_{IN} = 1$  kHz, 0.56 V<sub>PP</sub>)

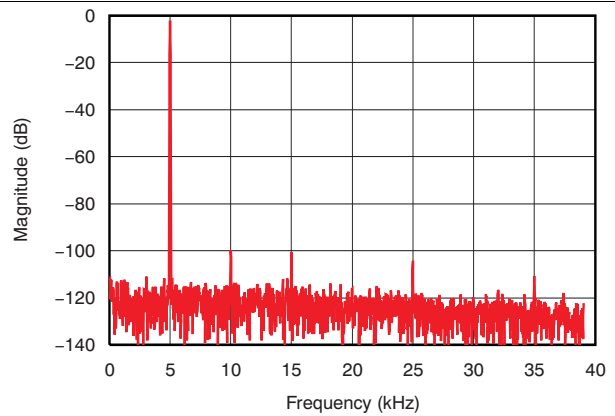

Figure 33. Frequency Spectrum (4096 Point FFT,  $f_{IN} = 5$  kHz, 0.56 V<sub>PP</sub>)

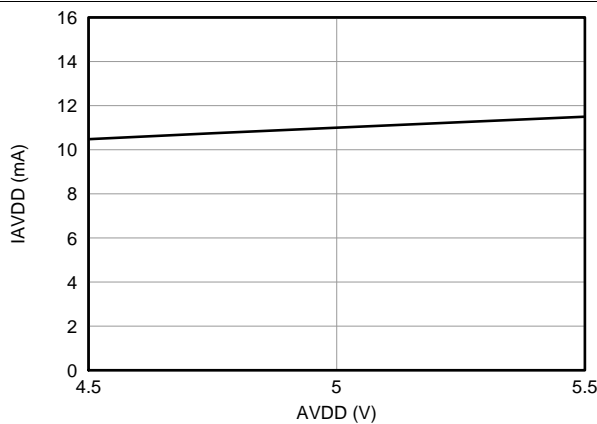

Figure 34. Analog Supply Current vs Analog Supply Voltage

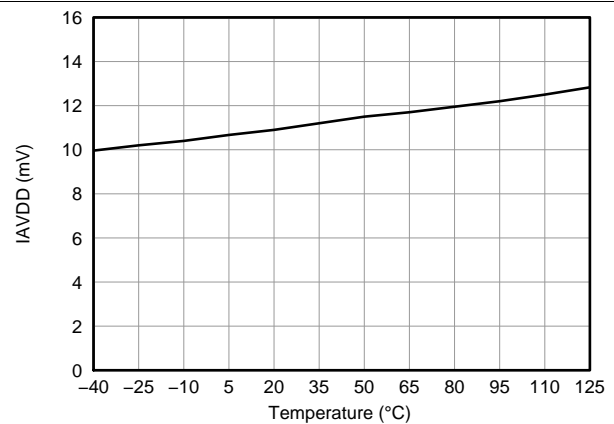

Figure 35. Analog Supply Current vs Temperature

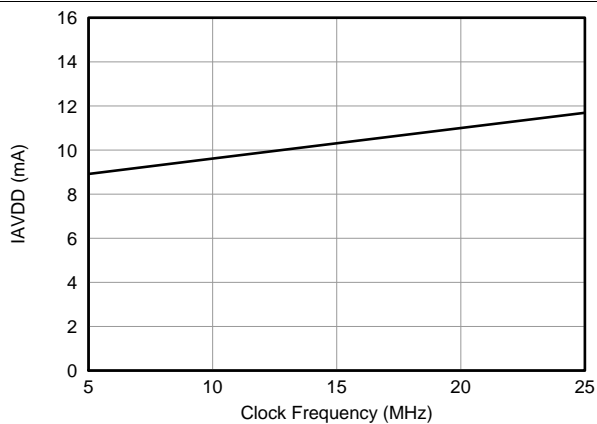

Figure 36. Analog Supply Current vs Clock Frequency

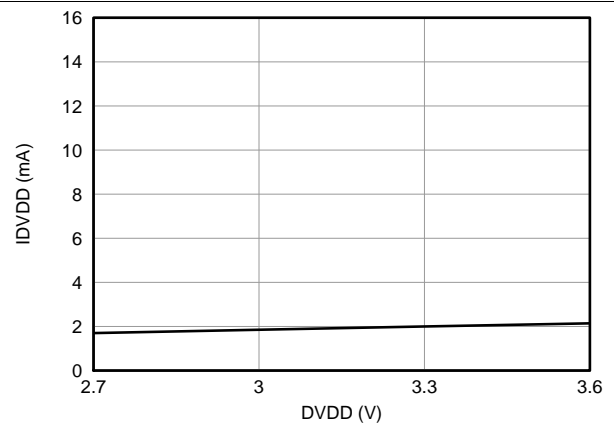
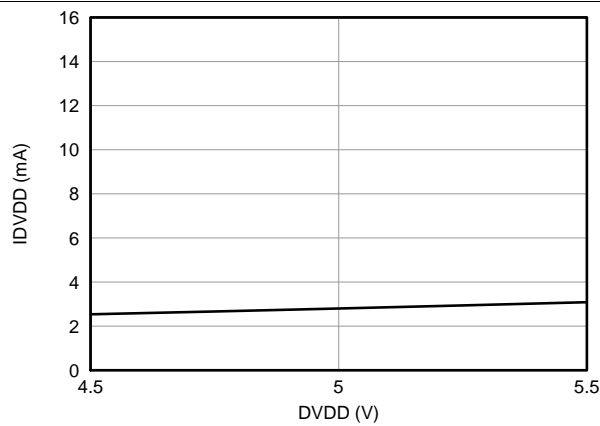

Figure 37. Digital Supply Current vs Digital Supply Voltage (3 V)

**Typical Characteristics (continued)**

At AVDD = 5 V, DVDD = 3.3 V, VINP = –250 mV to 250 mV, VINN = 0 V, and sinc<sup>3</sup> filter with OSR = 256, unless otherwise noted.



**Figure 38. Digital Supply Current vs Digital Supply Voltage (5 V)**

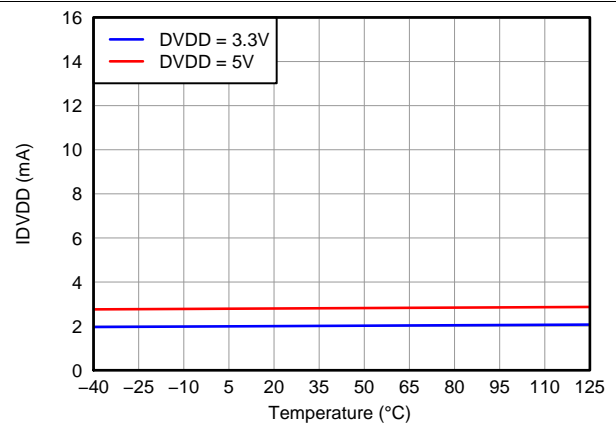

**Figure 39. Digital Supply Current vs Temperature**

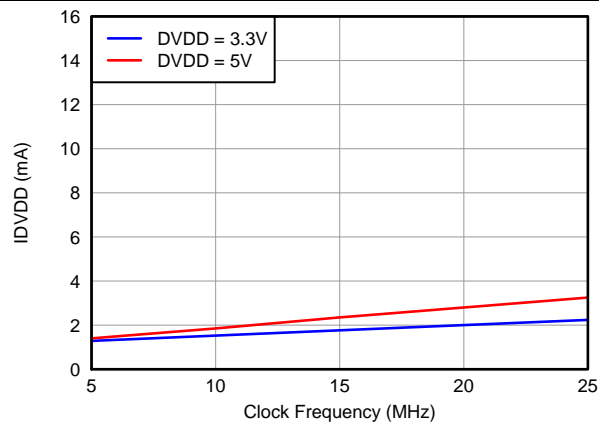

**Figure 40. Digital Supply Current vs Clock Frequency**



## 7 Detailed Description

### 7.1 Overview

The AMC1204 and AMC1204B are single-channel, second-order, delta-sigma ( $\Delta\Sigma$ ) modulators designed for medium- to high-resolution analog-to-digital conversions. The isolated output of the converter (DATA) provides a stream of digital ones and zeros accurately representing the analog input voltage over time. The time average of this serial output is proportional to the analog input voltage.

*Functional Block Diagram* shows a detailed block diagram of the AMC1204 and AMC1204B. The analog input range is tailored to directly accommodate the voltage drop across a shunt resistor used for current sensing. The SiO<sub>2</sub>-based capacitive isolation barrier supports a high level of magnetic field immunity as described in the application report *ISO72x Digital Isolator Magnetic-Field Immunity (SLLA181A)*. The external clock input simplifies the synchronization of multiple current sense channels on system level. The extended frequency range of up to 20 MHz supports higher performance levels compared to the other solutions available on the market.

### 7.2 Functional Block Diagram

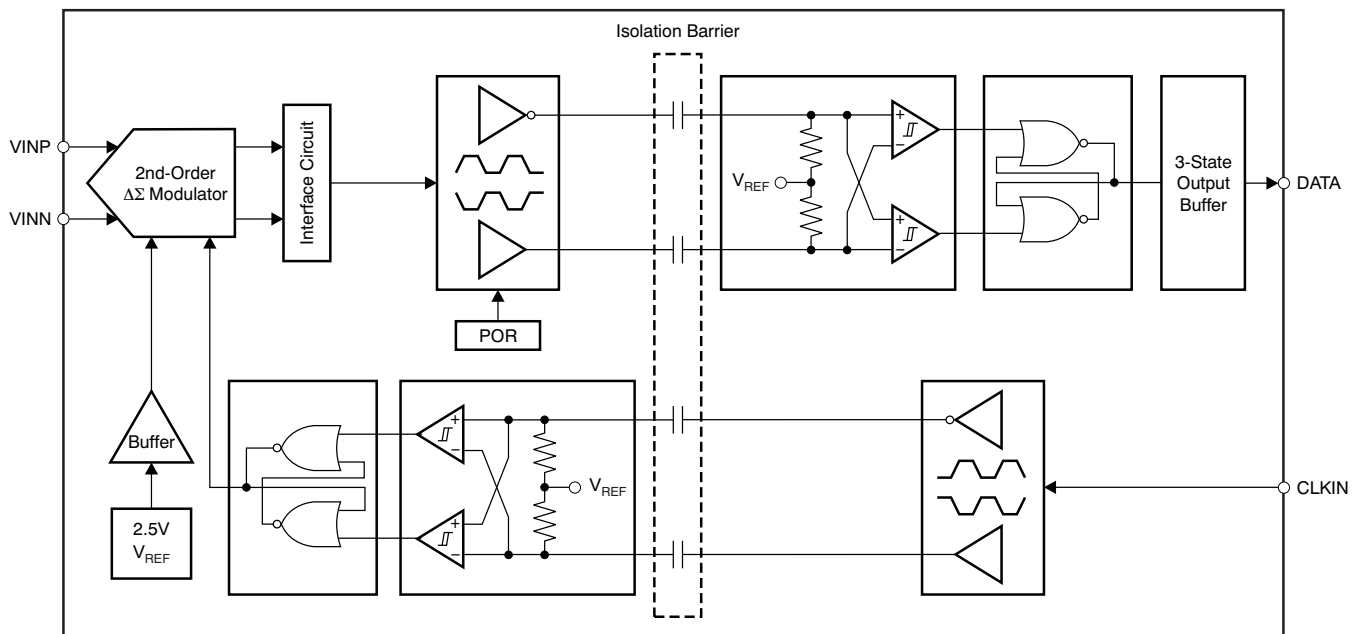

Figure 41. Detailed Block Diagram

### 7.3 Feature Description

#### 7.3.1 Analog Input

The differential analog input of the AMC1204 and AMC1204B is implemented with a switched-capacitor circuit.

The AMC1204 and AMC1204B measure the differential input signal  $V_{IN} = (VINP - VINN)$  against the internal reference of 2.5 V using internal capacitors that are continuously charged and discharged. Figure 42 shows the simplified schematic of the AMC1204 and AMC1204B input circuitry; the right side of Figure 42 illustrates the input circuitry with the capacitors and switches replaced by an equivalent circuit.

In Figure 42, the  $S_1$  switches close during the input sampling phase. With the  $S_1$  switches closed,  $C_{DIFF}$  charges to the voltage difference across  $VINP$  and  $VINN$ . For the discharge phase, both  $S_1$  switches open first and then both  $S_2$  switches close.  $C_{DIFF}$  discharges approximately to  $AGND + 0.8$  V during this phase. This two-phase sample/discharge cycle repeats with a period of  $t_{CLKIN} = 1/f_{CLKIN}$ .  $f_{CLKIN}$  is the operating frequency of the modulator. The capacitors  $C_{IP}$  and  $C_{IN}$  are of parasitic nature and caused by bonding wires and the internal ESD protection structure.

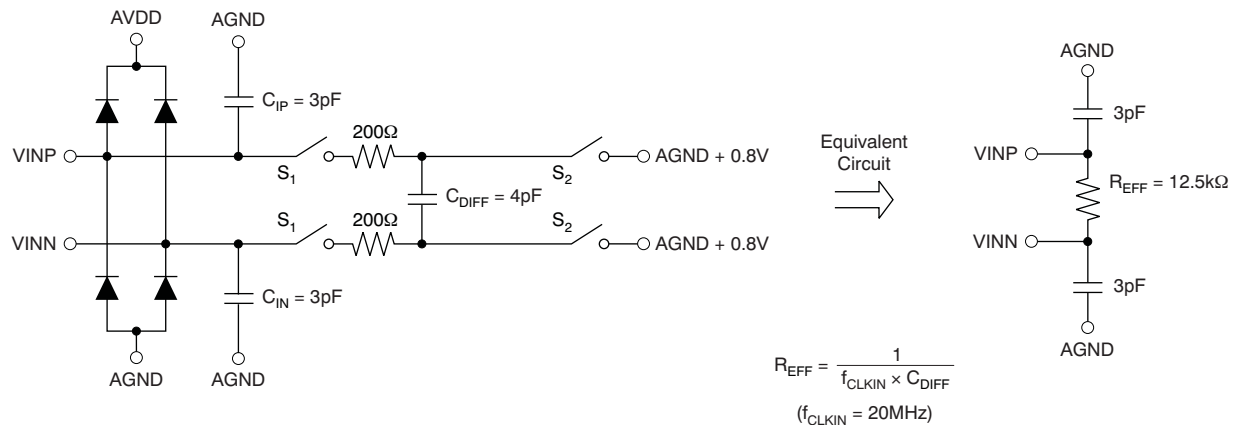
**Feature Description (continued)**

**Figure 42. Equivalent Analog Input Circuit**

There are two restrictions on the analog input signals VINP and VINN. First, if the input voltage exceeds the range AGND – 0.5 V to AVDD + 0.3 V, the input current must be limited to 10 mA because the input protection diodes on the front end of the converter begin to turn on. In addition, the linearity and the noise performance of the device are ensured only when the differential analog input voltage remains within  $\pm 250$  mV.

**7.3.2 Modulator**

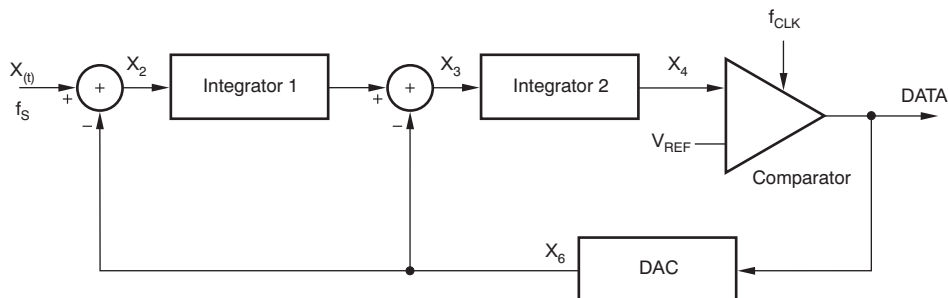
The modulator topology of the AMC1204 and AMC1204B is fundamentally a second-order, switched-capacitor,  $\Delta\Sigma$  modulator, such as the one conceptualized in Figure 43. The analog input voltage ( $X_{(t)}$ ) and the output of the 1-bit digital-to-analog converter (DAC) are differentiated, providing an analog voltage ( $X_2$ ) at the input of the first integrator or modulator stage. The output of the first integrator is further differentiated with the DAC output; the resulting voltage ( $X_3$ ) feeds the input of the second integrator stage. When the value of the integrated signal ( $X_4$ ) at the output of the second stage equals the comparator reference voltage, the output of the comparator switches from high to low, or vice versa, depending on its previous state. In this case, the 1-bit DAC responds on the next clock pulse by changing its analog output voltage ( $X_6$ ), causing the integrators to progress in the opposite direction, while forcing the value of the integrator output to track the average of the input.

**Figure 43. Block Diagram Of A Second-Order Modulator**

The modulator shifts the quantization noise to high frequencies, as shown in Figure 44; therefore, a low-pass digital filter should be used at the output of the device to increase the overall performance. This filter is also used to convert from the 1-bit data stream at a high sampling rate into a higher-bit data word at a lower rate (decimation). A digital signal processor (DSP), microcontroller ( $\mu C$ ), or field programmable gate array (FPGA) can be used to implement the filter.

## Feature Description (continued)

TI's microcontroller family [TMS320F28x7x](#) offers a suitable programmable, hardwired filter structure termed a *sigma-delta filter module* (SDFM) optimized for usage with the AMC1204, AMC1304 and AMC1305 devices. Also, the SD24\_B converters on the [MSP430F677x](#) microcontrollers offer a path to directly access the integrated sinc-filters, thus offering a system-level solution for multichannel isolated current sensing. Another option is to use a suitable application-specific device such as the [AMC1210](#), a four-channel digital sinc-filter.

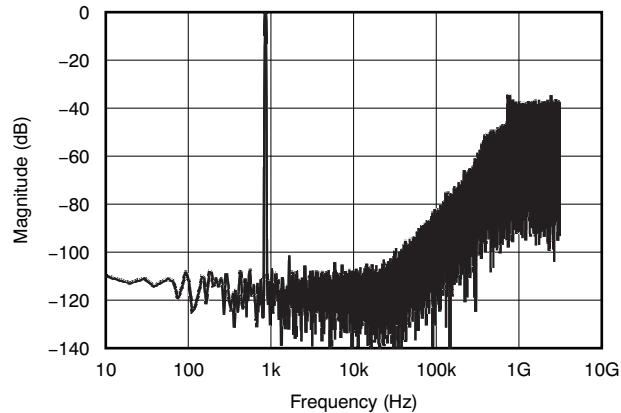

Figure 44. Quantization Noise Shaping

### 7.3.3 Digital Output

A differential input signal of 0 V ideally produces a stream of ones and zeros that are high 50% of the time and low 50% of the time. A differential input of 250 mV produces a stream of ones and zeros that are high 89.06% of the time. A differential input of -250 mV produces a stream of ones and zeros that are high 10.94% of the time. This is also the specified linear input range of the modulator with the performance as specified in this data sheet. The range between 250 mV and 320 mV (absolute values) is the non-linear range of the modulator. The output of the modulator clips with a stream of only zeros with an input less than or equal to -320 mV or with a stream of only ones with an input greater than or equal to 320 mV. The input voltage versus the output modulator signal is shown in [Figure 45](#).

The system clock of the AMC1204 and AMC1204B is typically 20 MHz and is provided externally at the CLKIN pin. The data are synchronously provided at 20 MHz at the DATA output pin. The data are changing at the falling edge of CLKIN; for more details see the [Timing Requirements](#) section.

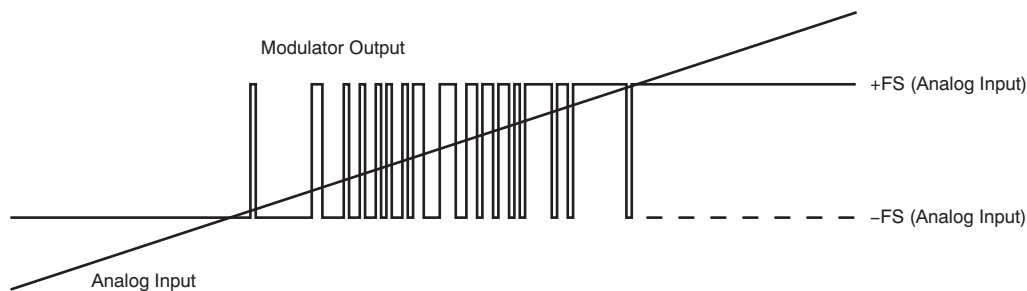

Figure 45. Analog Input Versus Amc1204 Modulator Output

## 7.4 Device Functional Modes

The AMC1204 is operational when the power supplies AVDD and DVDD are applied as specified in the [Recommended Operating Conditions](#) section.

The AMC1204 has no additional functional modes.

## 8 Application and Implementation

### NOTE

Information in the following applications sections is not part of the TI component specification, and TI does not warrant its accuracy or completeness. TI's customers are responsible for determining suitability of components for their purposes. Customers should validate and test their design implementation to confirm system functionality.

### 8.1 Application Information

#### 8.1.1 Digital Filter Usage

The modulator generates a bit stream that is processed by a digital filter to obtain a digital word similar to a conversion result of a conventional analog-to-digital converter (ADC). A very simple filter, built with minimal effort and hardware, is a sinc<sup>3</sup>-type filter, as shown in Equation 1:

$$H(z) = \left( \frac{1 - z^{-OSR}}{1 - z^{-1}} \right)^3 \tag{1}$$

This filter provides the best output performance at the lowest hardware size (count of digital gates). For an oversampling rate (OSR) in the range of 16 to 256, this filter is a good choice. All the characterization in this document is also done with a sinc<sup>3</sup> filter with OSR = 256 and an output word width of 16 bits.

In a sinc<sup>3</sup> filter response (shown in Figure 46 and Figure 47), the location of the first notch occurs at the frequency of output data rate  $f_{DATA} = f_{CLK}/OSR$ . The -3-dB point is located at half the Nyquist frequency or  $f_{DATA}/4$ . For some applications, it may be necessary to use another filter type with different frequency response. Performance can be improved, for example, by using a cascaded filter structure. The first decimation stage could be built of a sinc<sup>3</sup> filter with a low OSR and the second stage using a high-order filter.

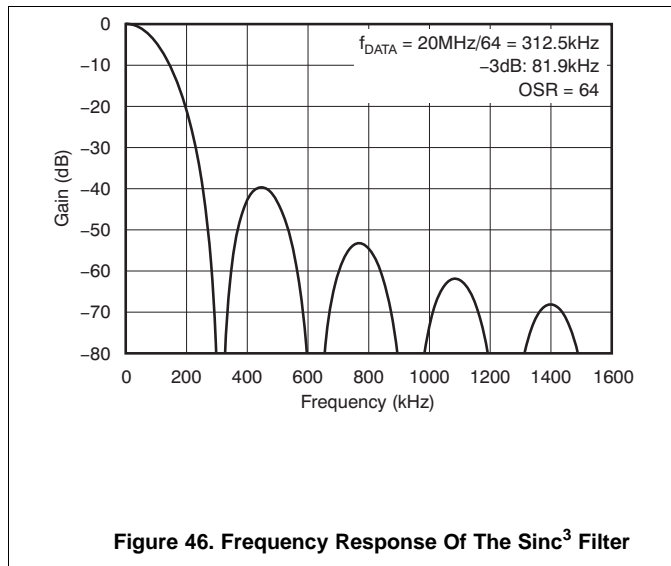

Figure 46. Frequency Response Of The Sinc<sup>3</sup> Filter

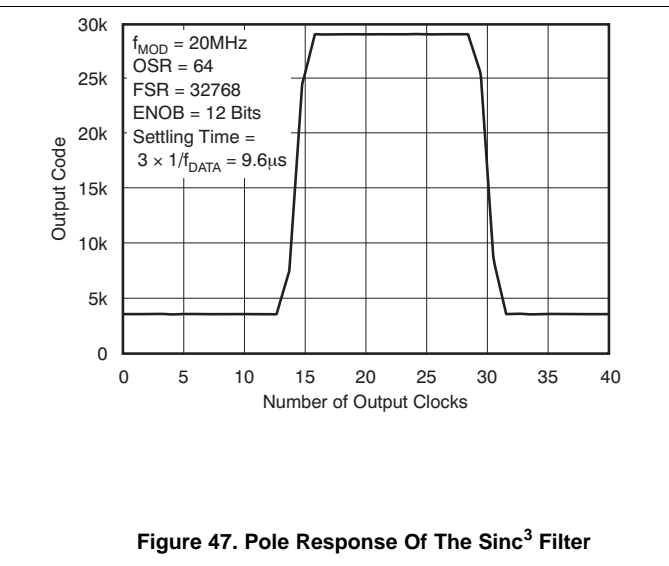

Figure 47. Pole Response Of The Sinc<sup>3</sup> Filter

The effective number of bits (ENOB) is often used to compare the performance of ADCs and  $\Delta\Sigma$  modulators. Figure 49 illustrates the ENOB of the AMC1204 and AMC1204B with different oversampling ratios. In this data sheet, this number is calculated from SNR using Equation 2:

$$SNR = 1.76dB + 6.02dB \times ENOB \tag{2}$$

An example code for an implementation of a sinc<sup>3</sup> filter in an FPGA follows. For more information, see the application note, *Combining ADS1202 with FPGA Digital Filter for Current Measurement in Motor Control Applications*, (SBAA094), available for download at [www.ti.com](http://www.ti.com).

## Application Information (continued)

```

library IEEE;
use IEEE.std_logic_1164.all;
use IEEE.std_logic_unsigned.all;

entity FLT is
  port(RESN, MOUT, MCLK, CNR : in std_logic;
       CN5 : out std_logic_vector(23 downto 0));
end FLT;

architecture RTL of FLT is
  signal DN0, DN1, DN3, DN5 : std_logic_vector(23 downto 0);
  signal CN1, CN2, CN3, CN4 : std_logic_vector(23 downto 0);
  signal DELTA1 : std_logic_vector(23 downto 0);
begin

  process(MCLK, RESn)
  begin
    if RESn = '0' then
      DELTA1 <= (others => '0');
    elsif MCLK'event and MCLK = '1' then
      if MOUT = '1' then
        DELTA1 <= DELTA1 + 1;
      end if;
    end if;
  end process;

  process(RESN, MCLK)
  begin
    if RESN = '0' then
      CN1 <= (others => '0');
      CN2 <= (others => '0');
    elsif MCLK'event and MCLK = '1' then
      CN1 <= CN1 + DELTA1;
      CN2 <= CN2 + CN1;
    end if;
  end process;

  process(RESN, CNR)
  begin
    if RESN = '0' then
      DN0 <= (others => '0');
      DN1 <= (others => '0');
      DN3 <= (others => '0');
      DN5 <= (others => '0');
    elsif CNR'event and CNR = '1' then
      DN0 <= CN2;
      DN1 <= DN0;
      DN3 <= CN3;
      DN5 <= CN4;
    end if;
  end process;

  CN3 <= DN0 - DN1;
  CN4 <= CN3 - DN3;
  CN5 <= CN4 - DN5;

end RTL;

```

## 8.2 Typical Application

### 8.2.1 Frequency Inverter Application

Because of their high AC and DC performance, isolated  $\Delta\Sigma$  modulators are being widely used in new generation frequency inverter designs. Frequency inverters are critical parts of industrial motor drives, photovoltaic inverters (string and central inverters), uninterruptible power supplies (UPS), electrical and hybrid vehicles, and other industrial applications. The input structure of the AMC1204 is optimized for use with low-impedance shunt resistors and is therefore tailored for isolated current sensing using shunts.

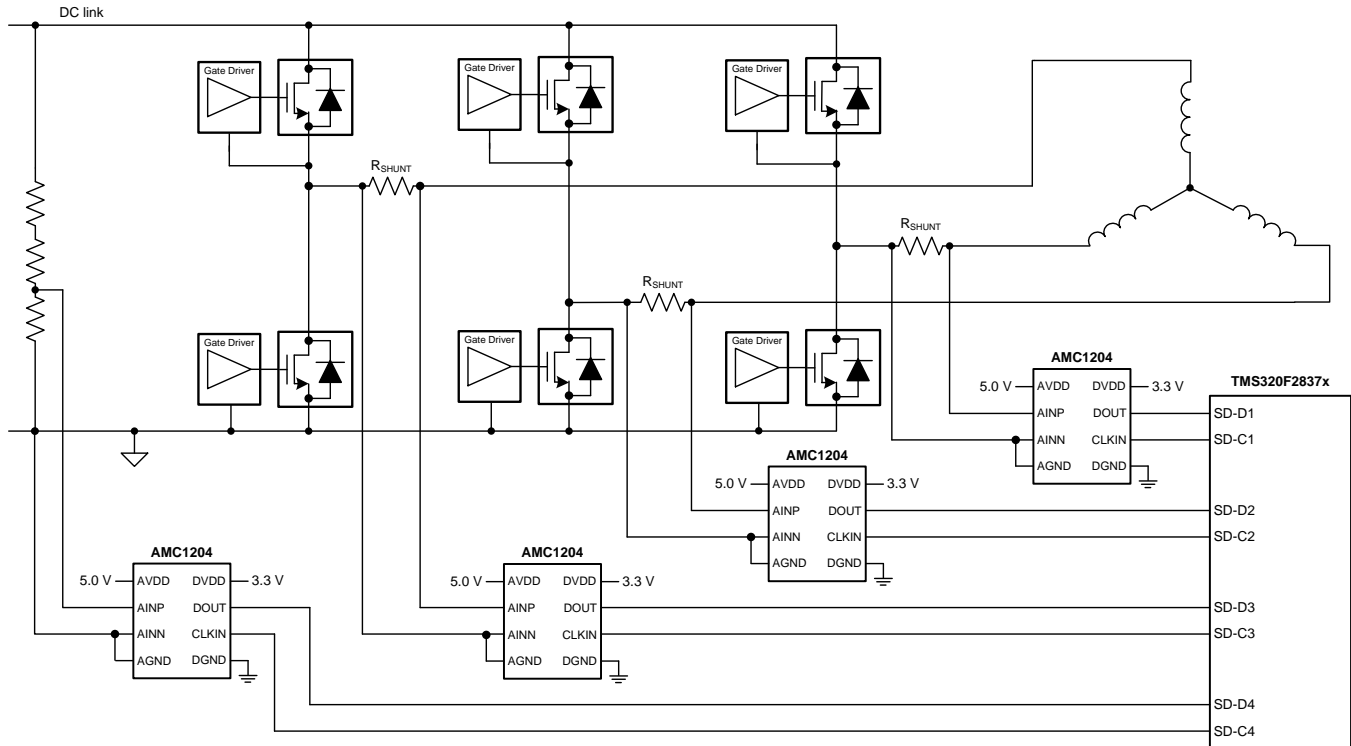

Figure 48. AMC1204 in a Frequency Inverter Application

#### 8.2.1.1 Design Requirements

Figure 48 shows a diagram of the AMC1204 in a typical frequency inverter. When the inverter stage is part of a motor drive system, measurement of the motor phase current is done via the shunt resistors ( $R_{SHUNT}$ ). Depending on the system design, either all three or only two phase currents are sensed.

In this example, an additional AMC1204 is used for isolated sensing of the DC link voltage. This high DC link voltage is reduced using a high-impedance resistive divider before being sensed by the AMC1204 across a smaller resistor. It is important to consider that the value of the resistor in the voltage divider can potentially degrade the performance of the measurement. Such phenomenon is described in the [Isolated Voltage Sensing](#) section.

#### 8.2.1.2 Detailed Design Procedure

For modulator output bit-stream filtering, TI recommends a device from TI's [TMS320F28x7x](#) family of MCUs. This family supports up to eight channels of dedicated hardware filter structures that significantly simplify system level design by offering two filtering paths per channel: one providing high accuracy results for the control loop and one fast response path for overcurrent detection.

## Typical Application (continued)

### 8.2.1.3 Application Curves

In motor control applications, a very fast response time for overcurrent detection is required. The time for fully settling the filter in case of a step-signal at the input of the modulator depends on its order; that is, a sinc<sup>3</sup> filter requires three data updates for full settling (with  $f_{\text{DATA}} = f_{\text{CLK}} / \text{OSR}$ ). Therefore, for overcurrent protection, filter types other than sinc<sup>3</sup> might be better choices. An alternative is, for example, the sinc<sup>2</sup> filter. Figure 50 compares the settling times of different filter orders.

Sincfast is a modified sinc<sup>2</sup> filter whose transfer function follows Equation 3.

$$H(z) = \left( \frac{1 - z^{-\text{OSR}}}{1 - z^{-1}} \right)^2 (1 + z^{-2\text{OSR}}) \quad (3)$$

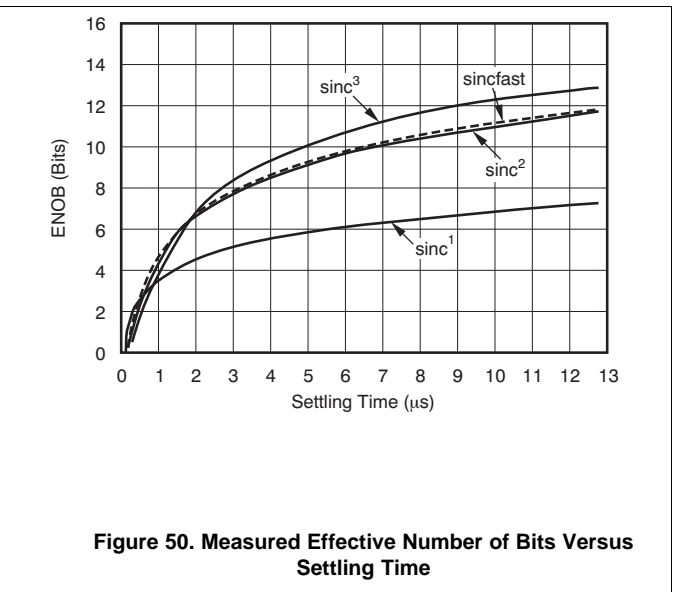
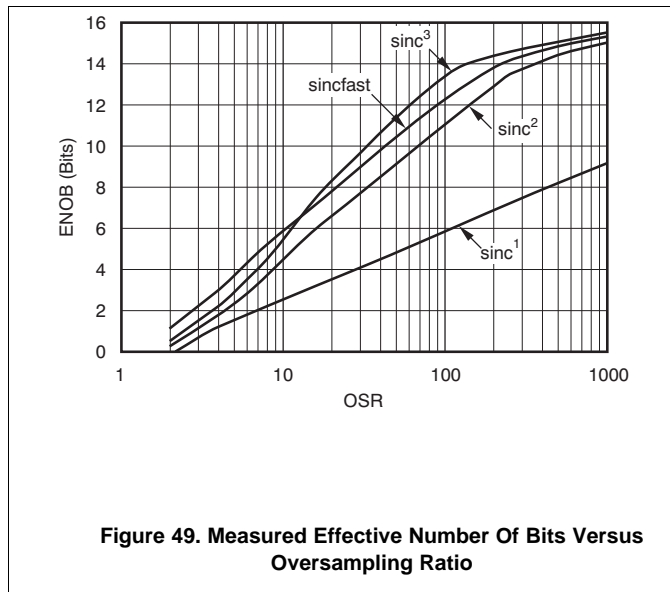

In the case of a continuous signal fed into a sinc filter, the time delay for such signal corresponds to half of the settling time shown in Figure 50.

Typical Application (continued)

8.2.2 Example of a Resolver-Based Motor Control Analog Front End

Figure 51 shows an example of two AMC1204 and AMC1204B devices and one ADS1209 (a dual-channel, 10-MHz, non-isolated modulator) connected to an AMC1210, building the entire analog front end of a resolver-based motor control application.

For detailed information on the ADS1209 and AMC1210, visit the respective device product folders at www.ti.com.

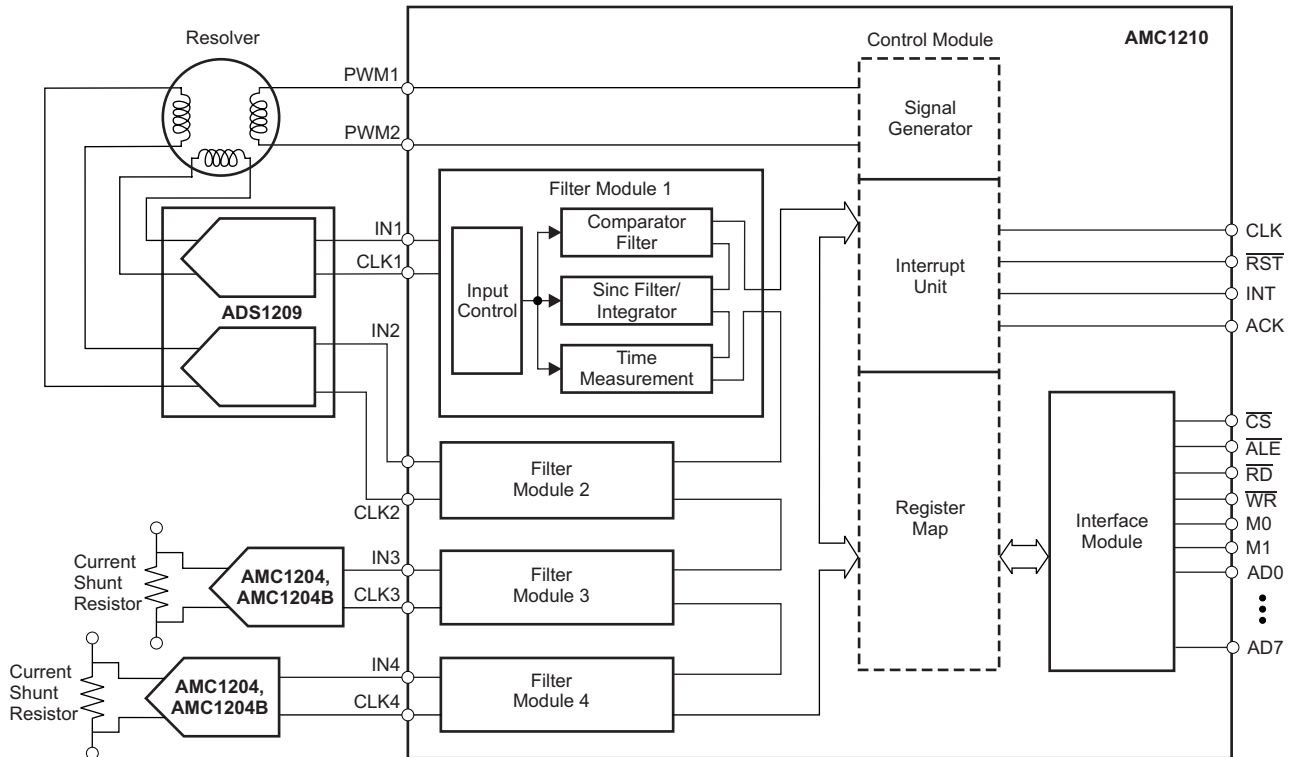

Figure 51. Example of a Resolver-Based Motor Control Analog Front End Schematic

8.2.3 Isolated Voltage Sensing

The AMC1204 is optimized for current-sensing applications using low-impedance shunts. However, the device can also be used in isolated voltage-sensing applications if the impact of the (usually higher) impedance of the resistor used in this case is considered. Figure 52 shows a simplified circuit typically used in high-voltage sensing applications.

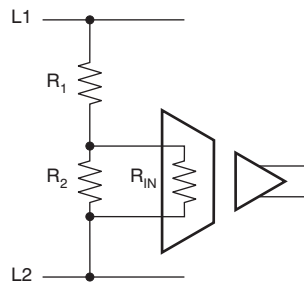

Figure 52. Voltage Measurement Application



## Typical Application (continued)

### 8.2.3.1 Design Requirements

In such applications, a resistor divider ( $R_1$  and  $R_2$ ) is used to match the relatively small input voltage range of the AMC device.  $R_2$  and the input resistance  $R_{IN}$  of the AMC1204 also create a resistor divider resulting in additional gain error. With the assumption that  $R_1$  and  $R_{IN}$  have a considerably higher value than  $R_2$ , use Equation 4 to estimate the resulting total gain error.

$$G_{ERRTOT} = G_{ERR} + \frac{R_2}{R_{IN}}$$

where

- $G_{ERR}$  = the gain error of AMC device. (4)

## 9 Power Supply Recommendations

In a typical frequency inverter application, the high-side power supply (AVDD) for the AMC1204 and AMC1204B is derived from the power supply of the upper gate driver. For lowest cost, a Zener diode can be used to limit the voltage to  $5\text{ V} \pm 10\%$ . TI recommends a decoupling capacitor of  $0.1\text{ }\mu\text{F}$  for filtering this power-supply path. This capacitor ( $C_1$  in Figure 53) should be placed as close as possible to the AVDD pin for best performance. If better filtering is required, an additional  $1\text{-}\mu\text{F}$  to  $10\text{-}\mu\text{F}$  capacitor can be used. The floating ground reference AGND is derived from the end of the shunt resistor, which is connected to the negative input (VINN) of the AMC1204 and AMC1204B. If a four-terminal shunt is used, the inputs of AMC1204 and AMC1204B are connected to the inner leads, while AGND is connected to one of the outer leads of the shunt. Both digital signals, CLKIN and DATA, can be directly connected to a digital filter.

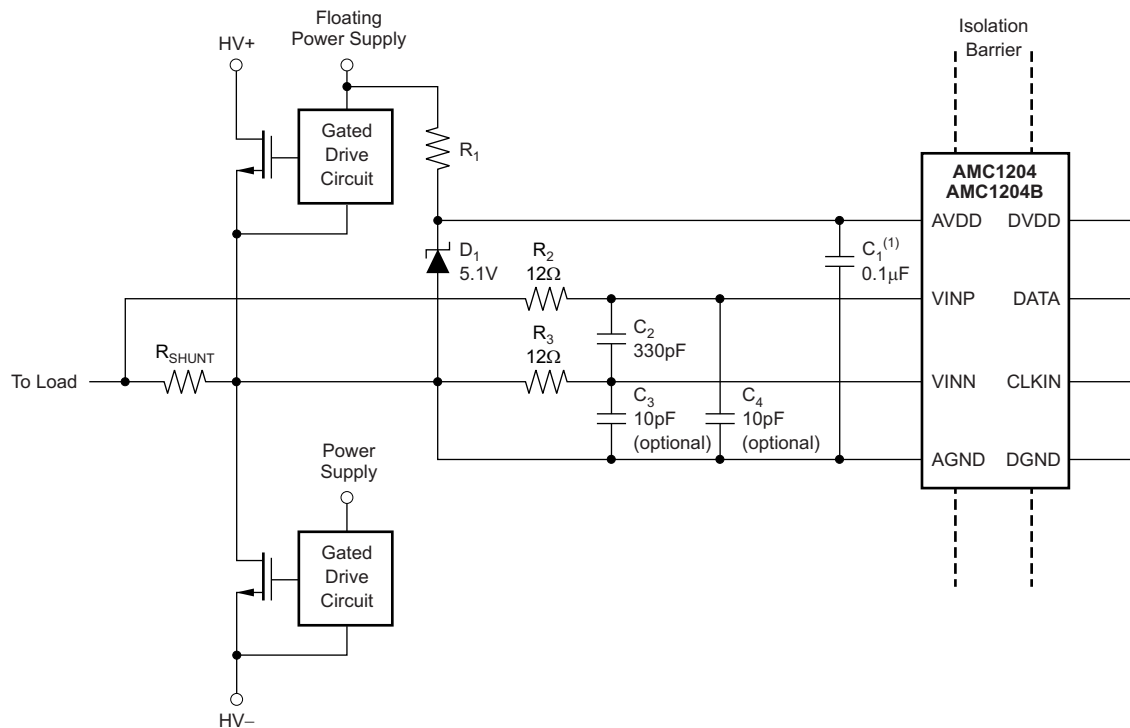

(1) Place  $C_1$  close to the AMC1204 and AMC1204B.

**Figure 53. Zener-Diode-Based High-Side Power Supply**

For better performance, the differential input signal is filtered using RC filters (components  $R_2$ ,  $R_3$ , and  $C_2$ ). Optionally,  $C_3$  and  $C_4$  can be used to reduce charge dumping from the inputs. In this case, care should be taken when choosing the quality of these capacitors: any mismatch in the capacitor values can cause a common-mode error at the input of the modulator.

## 10 Layout

### 10.1 Layout Guidelines

- Place the decoupling capacitors for AVDD and DVDD as close as possible to the AMC1204.
- Ensure that the traces that connect the shunt resistor to the RC filter on the VINP terminal are symmetrical to and have the same length as the traces connecting to the VINN terminal.
- The top and bottom PCB layers underneath the AMC1204 must be kept free of any conductive materials in order to comply with the creepage and clearance distances shown in the [Package Characteristics](#) section.

### 10.2 Layout Example

Figure 54 shows the recommended layout and placement of the decoupling capacitors and other components required by the AMC1204 and AMC1204B.

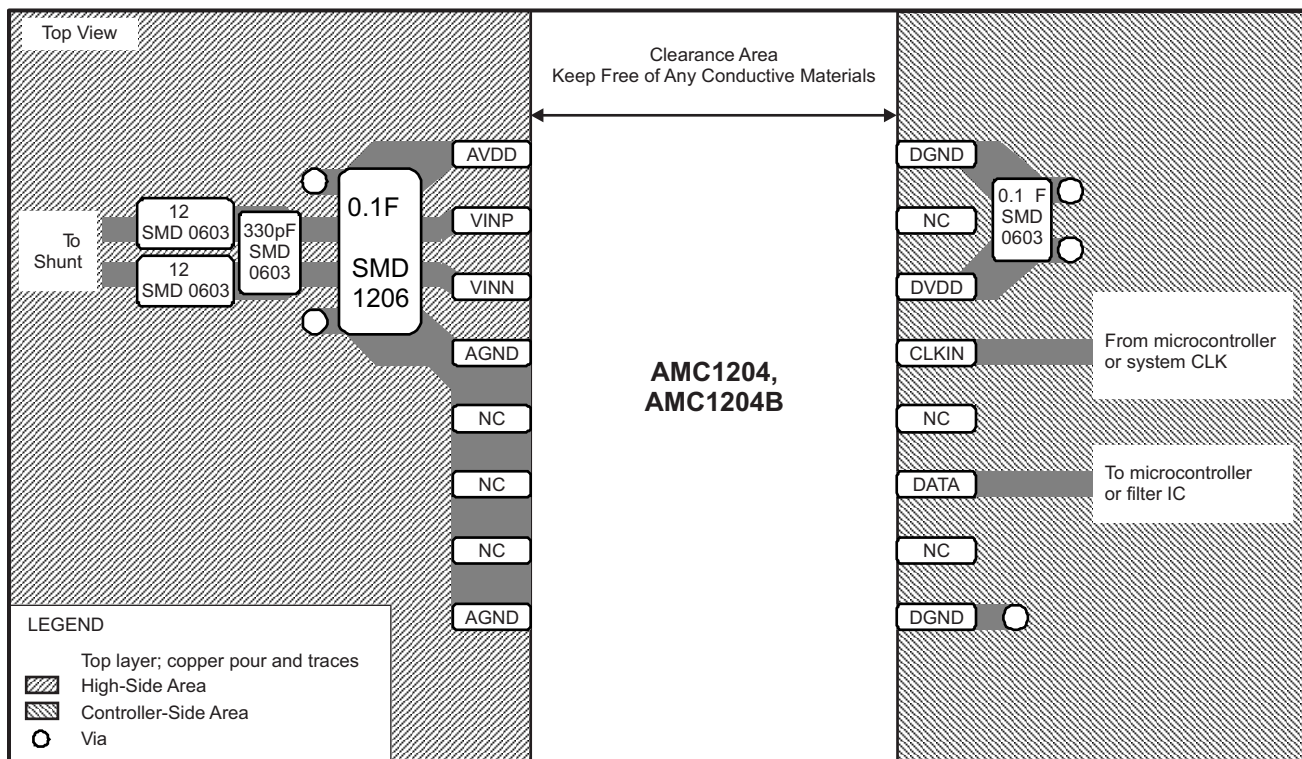

**Figure 54. Recommended Layout**

## 11 Device and Documentation Support

### 11.1 Documentation Support

#### 11.1.1 Related Documentation

For related documentation see the following:

- *ISO72x Digital Isolator Magnetic-Field Immunity*, [SLLA181](#)
- *Combining ADS1202 with FPGA Digital Filter for Current Measurement in Motor Control Applications*, [SBAA094](#)
- *Isolation Glossary*, [SLLA353](#)

#### 11.2 Related Links

The table below lists quick access links. Categories include technical documents, support and community resources, tools and software, and quick access to sample or buy.

**Table 1. Related Links**

PARTS	PRODUCT FOLDER	SAMPLE & BUY	TECHNICAL DOCUMENTS	TOOLS & SOFTWARE	SUPPORT & COMMUNITY
AMC1204	<a href="#">Click here</a>	<a href="#">Click here</a>	<a href="#">Click here</a>	<a href="#">Click here</a>	<a href="#">Click here</a>
AMC1204B	<a href="#">Click here</a>	<a href="#">Click here</a>	<a href="#">Click here</a>	<a href="#">Click here</a>	<a href="#">Click here</a>

#### 11.3 Community Resources

The following links connect to TI community resources. Linked contents are provided "AS IS" by the respective contributors. They do not constitute TI specifications and do not necessarily reflect TI's views; see TI's [Terms of Use](#).

**TI E2E™ Online Community** *TI's Engineer-to-Engineer (E2E) Community*. Created to foster collaboration among engineers. At [e2e.ti.com](http://e2e.ti.com), you can ask questions, share knowledge, explore ideas and help solve problems with fellow engineers.

**Design Support** *TI's Design Support* Quickly find helpful E2E forums along with design support tools and contact information for technical support.

#### 11.4 Trademarks

E2E is a trademark of Texas Instruments.  
All other trademarks are the property of their respective owners.

#### 11.5 Electrostatic Discharge Caution



These devices have limited built-in ESD protection. The leads should be shorted together or the device placed in conductive foam during storage or handling to prevent electrostatic damage to the MOS gates.

#### 11.6 Glossary

[SLYZ022](#) — *TI Glossary*.

This glossary lists and explains terms, acronyms, and definitions.

## 12 Mechanical, Packaging, and Orderable Information

The following pages include mechanical, packaging, and orderable information. This information is the most current data available for the designated devices. This data is subject to change without notice and revision of this document. For browser-based versions of this data sheet, refer to the left-hand navigation.

**PACKAGING INFORMATION**

Orderable Device	Status (1)	Package Type	Package Drawing	Pins	Package Qty	Eco Plan (2)	Lead/Ball Finish (6)	MSL Peak Temp (3)	Op Temp (°C)	Device Marking (4/5)	Samples
AMC1204BDW	ACTIVE	SOIC	DW	16	40	Green (RoHS & no Sb/Br)	CU NIPDAU	Level-3-260C-168 HR	-40 to 125	1204B	<a href="#">Samples</a>
AMC1204BDWR	ACTIVE	SOIC	DW	16	2000	Green (RoHS & no Sb/Br)	CU NIPDAU	Level-3-260C-168 HR	-40 to 125	1204B	<a href="#">Samples</a>
AMC1204BDWV	ACTIVE	SOIC	DWV	8	64	Green (RoHS & no Sb/Br)	CU SN	Level-3-260C-168 HR	-40 to 125	AMC1204B	<a href="#">Samples</a>
AMC1204BDWVR	ACTIVE	SOIC	DWV	8	1000	Green (RoHS & no Sb/Br)	CU SN	Level-3-260C-168 HR	-40 to 125	AMC1204B	<a href="#">Samples</a>
AMC1204DW	ACTIVE	SOIC	DW	16	40	Green (RoHS & no Sb/Br)	CU NIPDAU	Level-3-260C-168 HR	-40 to 125	AMC1204	<a href="#">Samples</a>
AMC1204DWR	ACTIVE	SOIC	DW	16	2000	Green (RoHS & no Sb/Br)	CU NIPDAU	Level-3-260C-168 HR	-40 to 125	AMC1204	<a href="#">Samples</a>

(1) The marketing status values are defined as follows:

**ACTIVE:** Product device recommended for new designs.

**LIFEBUY:** TI has announced that the device will be discontinued, and a lifetime-buy period is in effect.

**NRND:** Not recommended for new designs. Device is in production to support existing customers, but TI does not recommend using this part in a new design.

**PREVIEW:** Device has been announced but is not in production. Samples may or may not be available.

**OBSELETE:** TI has discontinued the production of the device.

(2) Eco Plan - The planned eco-friendly classification: Pb-Free (RoHS), Pb-Free (RoHS Exempt), or Green (RoHS & no Sb/Br) - please check <http://www.ti.com/productcontent> for the latest availability information and additional product content details.

**TBD:** The Pb-Free/Green conversion plan has not been defined.

**Pb-Free (RoHS):** TI's terms "Lead-Free" or "Pb-Free" mean semiconductor products that are compatible with the current RoHS requirements for all 6 substances, including the requirement that lead not exceed 0.1% by weight in homogeneous materials. Where designed to be soldered at high temperatures, TI Pb-Free products are suitable for use in specified lead-free processes.

**Pb-Free (RoHS Exempt):** This component has a RoHS exemption for either 1) lead-based flip-chip solder bumps used between the die and package, or 2) lead-based die adhesive used between the die and leadframe. The component is otherwise considered Pb-Free (RoHS compatible) as defined above.

**Green (RoHS & no Sb/Br):** TI defines "Green" to mean Pb-Free (RoHS compatible), and free of Bromine (Br) and Antimony (Sb) based flame retardants (Br or Sb do not exceed 0.1% by weight in homogeneous material)

(3) MSL, Peak Temp. - The Moisture Sensitivity Level rating according to the JEDEC industry standard classifications, and peak solder temperature.

(4) There may be additional marking, which relates to the logo, the lot trace code information, or the environmental category on the device.

(5) Multiple Device Markings will be inside parentheses. Only one Device Marking contained in parentheses and separated by a "~" will appear on a device. If a line is indented then it is a continuation of the previous line and the two combined represent the entire Device Marking for that device.

<sup>(6)</sup> Lead/Ball Finish - Orderable Devices may have multiple material finish options. Finish options are separated by a vertical ruled line. Lead/Ball Finish values may wrap to two lines if the finish value exceeds the maximum column width.

**Important Information and Disclaimer:**The information provided on this page represents TI's knowledge and belief as of the date that it is provided. TI bases its knowledge and belief on information provided by third parties, and makes no representation or warranty as to the accuracy of such information. Efforts are underway to better integrate information from third parties. TI has taken and continues to take reasonable steps to provide representative and accurate information but may not have conducted destructive testing or chemical analysis on incoming materials and chemicals. TI and TI suppliers consider certain information to be proprietary, and thus CAS numbers and other limited information may not be available for release.

In no event shall TI's liability arising out of such information exceed the total purchase price of the TI part(s) at issue in this document sold by TI to Customer on an annual basis.

**OTHER QUALIFIED VERSIONS OF AMC1204 :**

- Automotive: [AMC1204-Q1](#)

NOTE: Qualified Version Definitions:

- Automotive - Q100 devices qualified for high-reliability automotive applications targeting zero defects

## TAPE AND REEL INFORMATION



### QUADRANT ASSIGNMENTS FOR PIN 1 ORIENTATION IN TAPE



\*All dimensions are nominal

Device	Package Type	Package Drawing	Pins	SPQ	Reel Diameter (mm)	Reel Width W1 (mm)	A0 (mm)	B0 (mm)	K0 (mm)	P1 (mm)	W (mm)	Pin1 Quadrant
AMC1204BDWR	SOIC	DW	16	2000	330.0	16.4	10.75	10.7	2.7	12.0	16.0	Q1
AMC1204BDWVR	SOIC	DWV	8	1000	330.0	16.4	12.05	6.15	3.3	16.0	16.0	Q1
AMC1204DWR	SOIC	DW	16	2000	330.0	16.4	10.75	10.7	2.7	12.0	16.0	Q1

**TAPE AND REEL BOX DIMENSIONS**

\*All dimensions are nominal

Device	Package Type	Package Drawing	Pins	SPQ	Length (mm)	Width (mm)	Height (mm)
AMC1204BDWR	SOIC	DW	16	2000	367.0	367.0	38.0
AMC1204BDWVR	SOIC	DWV	8	1000	367.0	367.0	38.0
AMC1204DWR	SOIC	DW	16	2000	367.0	367.0	38.0



DWV0008A

SOIC - 2.8 mm max height

SOIC

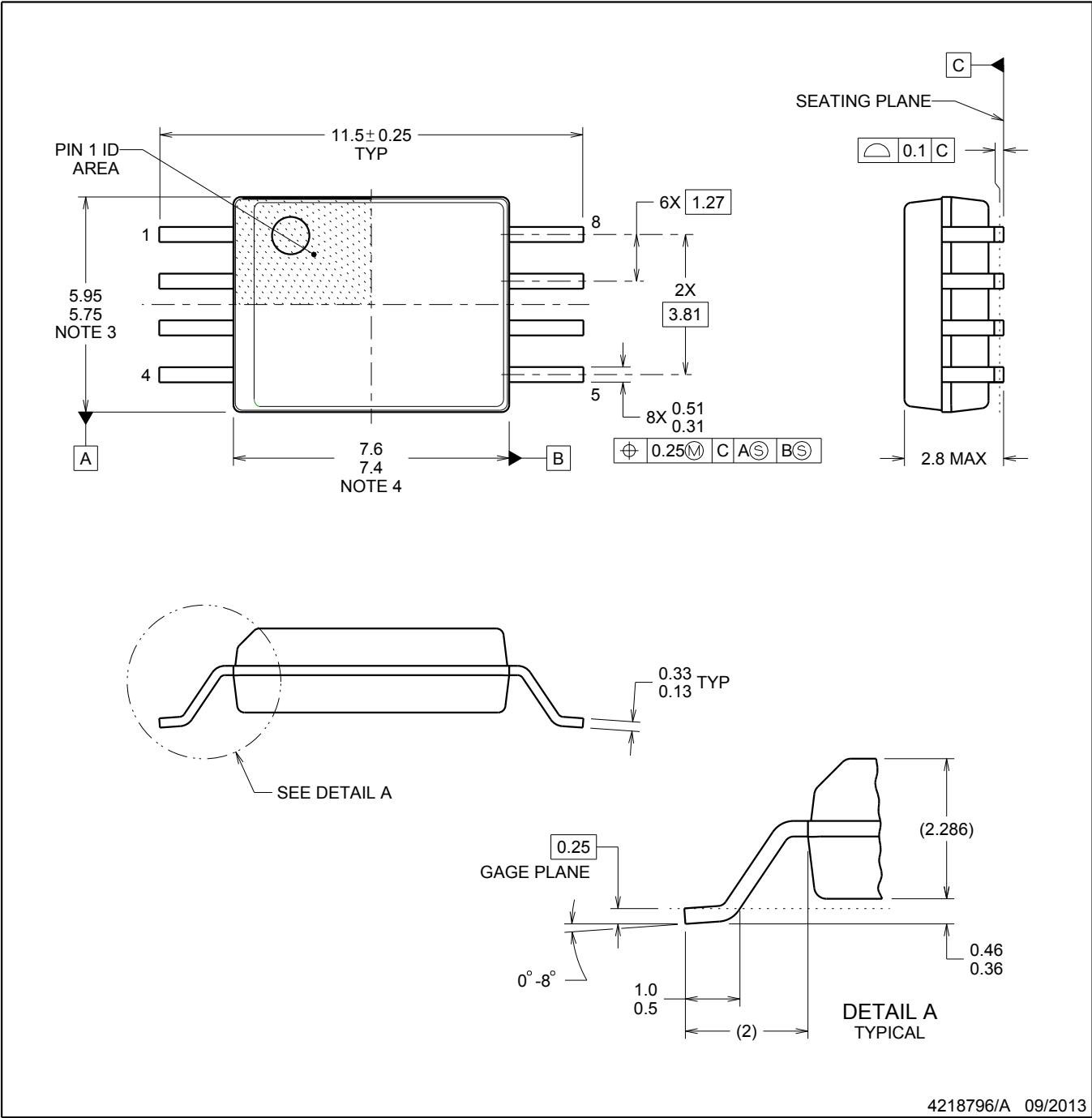

4218796/A 09/2013

NOTES:

1. All linear dimensions are in millimeters. Dimensions in parenthesis are for reference only. Dimensioning and tolerancing per ASME Y14.5M.
2. This drawing is subject to change without notice.
3. This dimension does not include mold flash, protrusions, or gate burrs. Mold flash, protrusions, or gate burrs shall not exceed 0.15 mm, per side.
4. This dimension does not include interlead flash. Interlead flash shall not exceed 0.25 mm, per side.





LAND PATTERN EXAMPLE  
 9.1 mm NOMINAL CLEARANCE/CREEPAGE  
 SCALE:6X

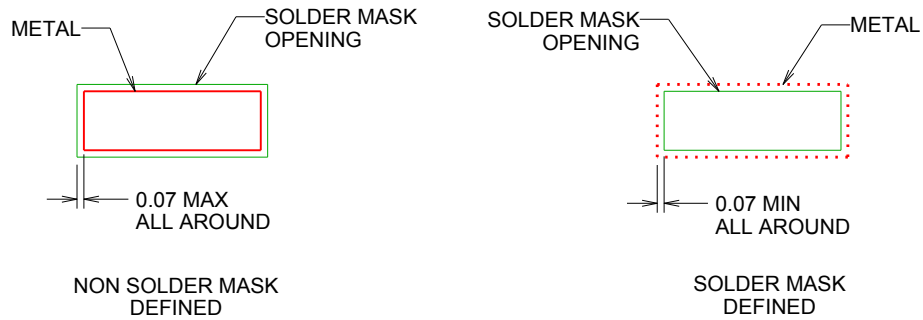

SOLDER MASK DETAILS

4218796/A 09/2013

NOTES: (continued)

- 5. Publication IPC-7351 may have alternate designs.
- 6. Solder mask tolerances between and around signal pads can vary based on board fabrication site.

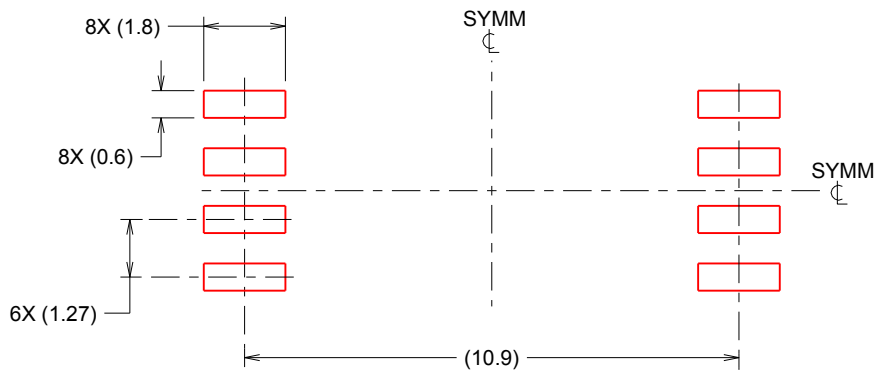

SOLDER PASTE EXAMPLE  
 BASED ON 0.125 mm THICK STENCIL  
 SCALE:6X

4218796/A 09/2013

NOTES: (continued)

- 7. Laser cutting apertures with trapezoidal walls and rounded corners may offer better paste release. IPC-7525 may have alternate design recommendations.
- 8. Board assembly site may have different recommendations for stencil design.

DW (R-PDSO-G16)

PLASTIC SMALL OUTLINE



- NOTES:
- A. All linear dimensions are in inches (millimeters). Dimensioning and tolerancing per ASME Y14.5M-1994.
  - B. This drawing is subject to change without notice.
  - C. Body dimensions do not include mold flash or protrusion not to exceed 0.006 (0,15).
  - D. Falls within JEDEC MS-013 variation AA.

DW (R-PDSO-G16)

PLASTIC SMALL OUTLINE

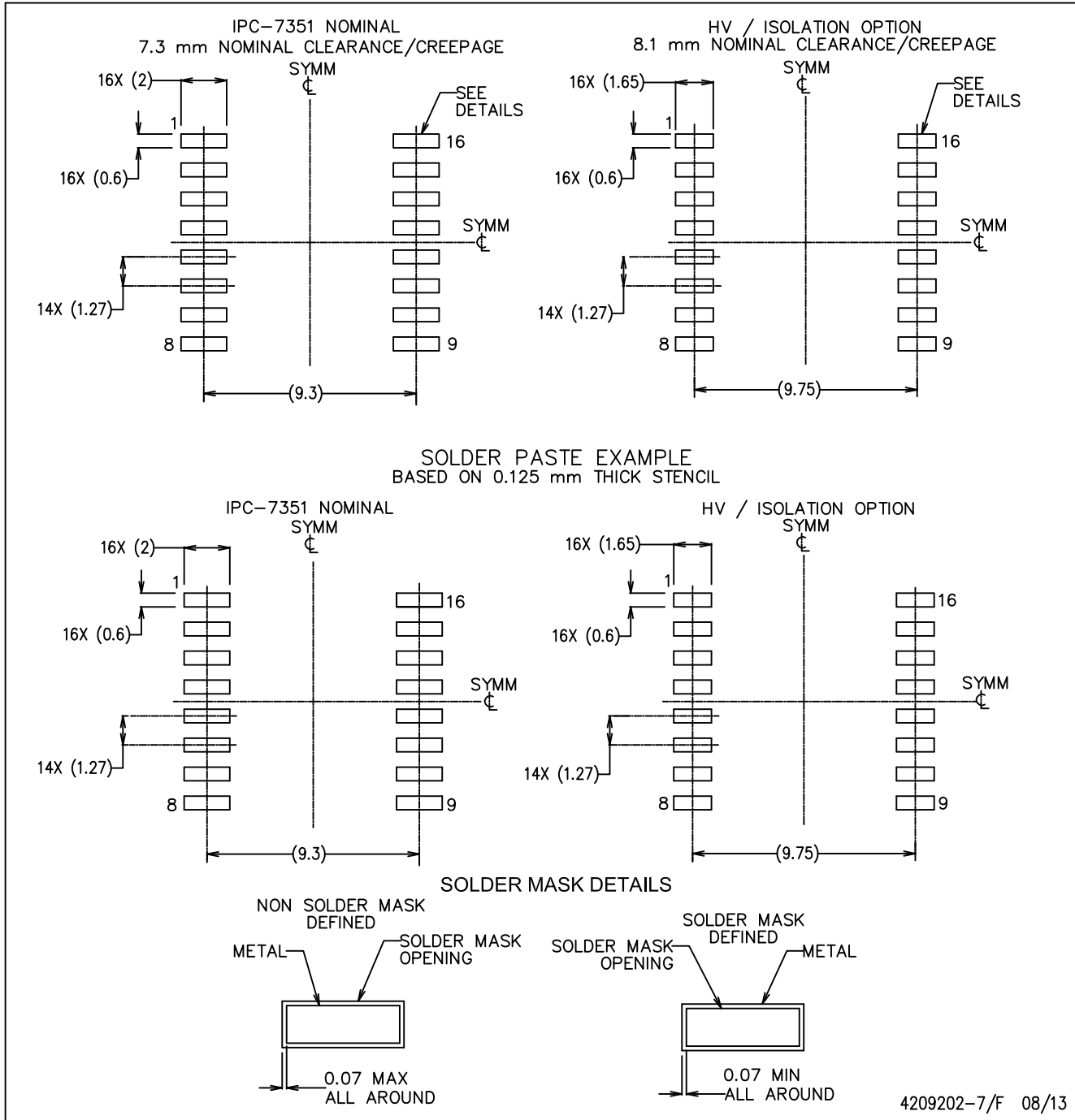

- NOTES:
- A. All linear dimensions are in millimeters.
  - B. This drawing is subject to change without notice.
  - C. Refer to IPC7351 for alternate board design.
  - D. Solder mask tolerances between and around signal pads can vary based on board fabrication site.
  - E. Laser cutting apertures with trapezoidal walls and rounded corners may offer better paste release. IPC-7525 may have alternate design recommendations.
  - F. Board assembly site may have different recommendations for stencil design.

## IMPORTANT NOTICE

Texas Instruments Incorporated (TI) reserves the right to make corrections, enhancements, improvements and other changes to its semiconductor products and services per JESD46, latest issue, and to discontinue any product or service per JESD48, latest issue. Buyers should obtain the latest relevant information before placing orders and should verify that such information is current and complete.

TI's published terms of sale for semiconductor products (<http://www.ti.com/sc/docs/stdterms.htm>) apply to the sale of packaged integrated circuit products that TI has qualified and released to market. Additional terms may apply to the use or sale of other types of TI products and services.

Reproduction of significant portions of TI information in TI data sheets is permissible only if reproduction is without alteration and is accompanied by all associated warranties, conditions, limitations, and notices. TI is not responsible or liable for such reproduced documentation. Information of third parties may be subject to additional restrictions. Resale of TI products or services with statements different from or beyond the parameters stated by TI for that product or service voids all express and any implied warranties for the associated TI product or service and is an unfair and deceptive business practice. TI is not responsible or liable for any such statements.

Buyers and others who are developing systems that incorporate TI products (collectively, "Designers") understand and agree that Designers remain responsible for using their independent analysis, evaluation and judgment in designing their applications and that Designers have full and exclusive responsibility to assure the safety of Designers' applications and compliance of their applications (and of all TI products used in or for Designers' applications) with all applicable regulations, laws and other applicable requirements. Designer represents that, with respect to their applications, Designer has all the necessary expertise to create and implement safeguards that (1) anticipate dangerous consequences of failures, (2) monitor failures and their consequences, and (3) lessen the likelihood of failures that might cause harm and take appropriate actions. Designer agrees that prior to using or distributing any applications that include TI products, Designer will thoroughly test such applications and the functionality of such TI products as used in such applications.

TI's provision of technical, application or other design advice, quality characterization, reliability data or other services or information, including, but not limited to, reference designs and materials relating to evaluation modules, (collectively, "TI Resources") are intended to assist designers who are developing applications that incorporate TI products; by downloading, accessing or using TI Resources in any way, Designer (individually or, if Designer is acting on behalf of a company, Designer's company) agrees to use any particular TI Resource solely for this purpose and subject to the terms of this Notice.

TI's provision of TI Resources does not expand or otherwise alter TI's applicable published warranties or warranty disclaimers for TI products, and no additional obligations or liabilities arise from TI providing such TI Resources. TI reserves the right to make corrections, enhancements, improvements and other changes to its TI Resources. TI has not conducted any testing other than that specifically described in the published documentation for a particular TI Resource.

Designer is authorized to use, copy and modify any individual TI Resource only in connection with the development of applications that include the TI product(s) identified in such TI Resource. NO OTHER LICENSE, EXPRESS OR IMPLIED, BY ESTOPPEL OR OTHERWISE TO ANY OTHER TI INTELLECTUAL PROPERTY RIGHT, AND NO LICENSE TO ANY TECHNOLOGY OR INTELLECTUAL PROPERTY RIGHT OF TI OR ANY THIRD PARTY IS GRANTED HEREIN, including but not limited to any patent right, copyright, mask work right, or other intellectual property right relating to any combination, machine, or process in which TI products or services are used. Information regarding or referencing third-party products or services does not constitute a license to use such products or services, or a warranty or endorsement thereof. Use of TI Resources may require a license from a third party under the patents or other intellectual property of the third party, or a license from TI under the patents or other intellectual property of TI.

TI RESOURCES ARE PROVIDED "AS IS" AND WITH ALL FAULTS. TI DISCLAIMS ALL OTHER WARRANTIES OR REPRESENTATIONS, EXPRESS OR IMPLIED, REGARDING RESOURCES OR USE THEREOF, INCLUDING BUT NOT LIMITED TO ACCURACY OR COMPLETENESS, TITLE, ANY EPIDEMIC FAILURE WARRANTY AND ANY IMPLIED WARRANTIES OF MERCHANTABILITY, FITNESS FOR A PARTICULAR PURPOSE, AND NON-INFRINGEMENT OF ANY THIRD PARTY INTELLECTUAL PROPERTY RIGHTS. TI SHALL NOT BE LIABLE FOR AND SHALL NOT DEFEND OR INDEMNIFY DESIGNER AGAINST ANY CLAIM, INCLUDING BUT NOT LIMITED TO ANY INFRINGEMENT CLAIM THAT RELATES TO OR IS BASED ON ANY COMBINATION OF PRODUCTS EVEN IF DESCRIBED IN TI RESOURCES OR OTHERWISE. IN NO EVENT SHALL TI BE LIABLE FOR ANY ACTUAL, DIRECT, SPECIAL, COLLATERAL, INDIRECT, PUNITIVE, INCIDENTAL, CONSEQUENTIAL OR EXEMPLARY DAMAGES IN CONNECTION WITH OR ARISING OUT OF TI RESOURCES OR USE THEREOF, AND REGARDLESS OF WHETHER TI HAS BEEN ADVISED OF THE POSSIBILITY OF SUCH DAMAGES.

Unless TI has explicitly designated an individual product as meeting the requirements of a particular industry standard (e.g., ISO/TS 16949 and ISO 26262), TI is not responsible for any failure to meet such industry standard requirements.

Where TI specifically promotes products as facilitating functional safety or as compliant with industry functional safety standards, such products are intended to help enable customers to design and create their own applications that meet applicable functional safety standards and requirements. Using products in an application does not by itself establish any safety features in the application. Designers must ensure compliance with safety-related requirements and standards applicable to their applications. Designer may not use any TI products in life-critical medical equipment unless authorized officers of the parties have executed a special contract specifically governing such use. Life-critical medical equipment is medical equipment where failure of such equipment would cause serious bodily injury or death (e.g., life support, pacemakers, defibrillators, heart pumps, neurostimulators, and implantables). Such equipment includes, without limitation, all medical devices identified by the U.S. Food and Drug Administration as Class III devices and equivalent classifications outside the U.S.

TI may expressly designate certain products as completing a particular qualification (e.g., Q100, Military Grade, or Enhanced Product). Designers agree that it has the necessary expertise to select the product with the appropriate qualification designation for their applications and that proper product selection is at Designers' own risk. Designers are solely responsible for compliance with all legal and regulatory requirements in connection with such selection.

Designer will fully indemnify TI and its representatives against any damages, costs, losses, and/or liabilities arising out of Designer's non-compliance with the terms and provisions of this Notice.