



+2.7 V to +5.5 V, I²C INTERFACE (RECEIVE ONLY), VOLTAGE OUTPUT, 12-BIT DIGITAL-TO-ANALOG CONVERTER

Check for Samples: [DAC7571](#)

FEATURES

- **Micropower Operation: 140 μ A @ 5 V**
- **Power-On Reset to Zero**
- **+2.7-V to +5.5-V Power Supply**
- **Specified Monotonic by Design**
- **Settling Time: 10 μ s to $\pm 0.003\%$ FS**
- **I²C™ Interface up to 3.4 Mbps**
- **On-Chip Output Buffer Amplifier, Rail-to-Rail Operation**
- **Double-Buffered Input Register**
- **Address Support for up to Two DAC7571s**
- **Small 6-Lead SOT Package**
- **Operation From -40°C to 105°C**

APPLICATIONS

- **Process Control**
- **Data Acquisition Systems**
- **Closed-Loop Servo Control**
- **PC Peripherals**
- **Portable Instrumentation**

DESCRIPTION

The DAC7571 is a low-power, single channel, 12-bit buffered voltage output DAC. Its on-chip precision output amplifier allows rail-to-rail output swing to be achieved. The DAC7571 utilizes an I²C compatible two wire serial interface that operates at clock rates up to 3.4 Mbps with address support of up to two DAC7571s on the same data bus.

The output voltage range of the DAC is set to V_{DD} . The DAC7571 incorporates a power-on-reset circuit that ensures that the DAC output powers up at zero volts and remains there until a valid write to the device takes place. The DAC7571 contains a power-down feature, accessed via the internal control register, that reduces the current consumption of the device to 50 nA at 5 V.

The low power consumption of this part in normal operation makes it ideally suited for portable battery operated equipment. The power consumption is less than 0.7 mW at $V_{DD} = 5$ V reducing to 1 μ W in power-down mode.

The DAC7571 is available in a 6-lead SOT 23 package.

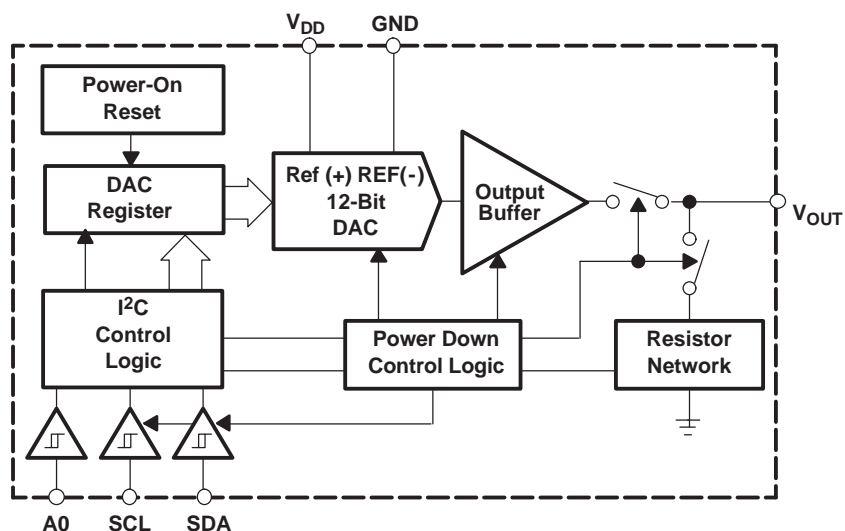

Please be aware that an important notice concerning availability, standard warranty, and use in critical applications of Texas Instruments semiconductor products and disclaimers thereto appears at the end of this data sheet.

I²C is a trademark of Philips Corporation.

These devices have limited built-in ESD protection. The leads should be shorted together or the device placed in conductive foam during storage or handling to prevent electrostatic damage to the MOS gates.



This integrated circuit can be damaged by ESD. Texas Instruments recommends that all integrated circuits be handled with appropriate precautions. Failure to observe proper handling and installation procedures can cause damage.

ESD damage can range from subtle performance degradation to complete device failure. Precision integrated circuits may be more susceptible to damage because very small parametric changes could cause the device not to meet its published specifications.

PACKAGE/ORDERING INFORMATION

PRODUCT	PACKAGE	PACKAGE DESIGNATOR	SPECIFIED TEMPERATURE RANGE	PACKAGE MARKING	ORDERING NUMBER	TRANSPORT MEDIA
DAC7571	SOT23-6	DBV	-40°C to +105°C	D771	DAC7571IDBVT	250-Piece Small Tape and Reel
					DAC7571IDBVR	3000-Piece Tape and Reel

PIN CONFIGURATIONS

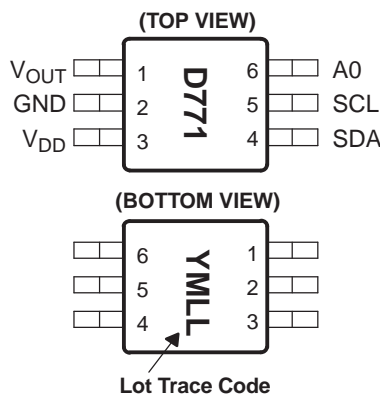

PIN DESCRIPTION (SOT23-6)

PIN	NAME	DESCRIPTION
1	V _{OUT}	Analog output voltage from DAC
2	GND	Ground reference point for all circuitry on the part
3	V _{DD}	Analog Voltage Supply Input
4	SDA	Serial Data Input
5	SCL	Serial Clock Input
6	A0	Device Address Select
LOT TRACE CODE:	Year (3 = 2003); Month (1–9 = JAN–SEP; A=OCT, B=NOV, C=DEC); LL – Random code generated when assembly is requested	

ABSOLUTE MAXIMUM RATINGS⁽¹⁾

	UNITS	
V _{DD} to GND	-0.3 V to +6 V	
Digital Input voltage to GND	-0.3 V to +V _{DD} +0.3 V	
V _{OUT} to GND	-0.3 V to +V _{DD} +0.3 V	
Operating temperature range	-40°C to +105°C	
Storage temperature range	-65°C to +150°C	
Junction temperature range (T _J max)	+150°C	
Power dissipation	(T _J max - T _A)R _{θJA}	
Thermal impedance, R _{θJA}	240°C/W	
Lead temperature, soldering	Vapor phase (60 s)	215°C
	Infrared (15 s)	220°C

(1) Stresses above those listed under "Absolute Maximum Ratings" may cause permanent damage to the device. Exposure to absolute maximum conditions for extended periods may affect device reliability.

ELECTRICAL CHARACTERISTICS

V_{DD} = +2.7 V to +5.5 V; R_L = 2 kΩ to GND; C_L = 200 pF to GND; all specifications -40°C to +105°C unless otherwise noted.

PARAMETER	CONDITIONS	DAC7571			UNITS
		MIN	TYP	MAX	
STATIC PERFORMANCE⁽¹⁾					
Resolution		12			Bits
Relative accuracy				±0.195	% of FSR

(1) Linearity calculated using a reduced code range of 48 to 4047; output unloaded.

ELECTRICAL CHARACTERISTICS (continued)
 $V_{DD} = +2.7\text{ V to }+5.5\text{ V}$; $R_L = 2\text{ k}\Omega$ to GND; $C_L = 200\text{ pF}$ to GND; all specifications $-40^\circ\text{C to }+105^\circ\text{C}$ unless otherwise noted.

PARAMETER	CONDITIONS	DAC7571			UNITS	
		MIN	TYP	MAX		
Differential nonlinearity	Assured monotonic by design			± 1	LSB	
Zero code error			5	20	mV	
Full-scale error	All ones loaded to DAC register		-0.15	-1.25	% of FSR	
Gain error				± 1.25	% of FSR	
Zero code error drift			± 7		$\mu\text{V}/^\circ\text{C}$	
Gain temperature coefficient			± 3		ppm of FSR/ $^\circ\text{C}$	
OUTPUT CHARACTERISTICS⁽²⁾						
Output voltage range		0		V_{DD}	V	
Output voltage settling time	1/4 Scale to 3/4 scale change (400_{H} to $C00_{\text{H}}$)		8	10	μs	
Slew rate			1		V/ μs	
Capacitive load stability	$R_L = \infty$		470		pF	
	$R_L = 2\text{ k}\Omega$		1000		pF	
Code change glitch impulse	1 LSB Change around major carry		20		nV-s	
Digital feedthrough			0.5		nV-s	
DC output impedance			1		Ω	
Short-circuit current	$V_{DD} = +5\text{ V}$		50		mA	
	$V_{DD} = +3\text{ V}$		20		mA	
Power-up time	Coming out of power-down mode, $V_{DD} = +5\text{ V}$		2.5		μs	
	Coming out of power-down mode, $V_{DD} = +3\text{ V}$		5		μs	
LOGIC INPUTS⁽³⁾						
Input current				± 1	μA	
V_{INL} , Input low voltage	$V_{DD} = +3\text{ V}$			$0.3 \times V_{DD}$	V	
V_{INH} , Input high voltage	$V_{DD} = +5\text{ V}$	$0.7 \times V_{DD}$			V	
Pin capacitance				3	pF	
POWER REQUIREMENTS						
V_{DD}		2.7		5.5	V	
I_{DD} (normal operation)	DAC active and excluding load current					
	$V_{DD} = +3.6\text{ V to }+5.5\text{ V}$		$V_{\text{IH}} = V_{DD}$ and $V_{\text{IL}} = \text{GND}$	135	200	μA
	$V_{DD} = +2.7\text{ V to }+3.6\text{ V}$		$V_{\text{IH}} = V_{DD}$ and $V_{\text{IL}} = \text{GND}$	115	160	μA
I_{DD} (all power-down modes)						
	$V_{DD} = +3.6\text{ V to }+5.5\text{ V}$		$V_{\text{IH}} = V_{DD}$ and $V_{\text{IL}} = \text{GND}$	0.2	1	μA
	$V_{DD} = +2.7\text{ V to }+3.6\text{ V}$		$V_{\text{IH}} = V_{DD}$ and $V_{\text{IL}} = \text{GND}$	0.05	1	μA
POWER EFFICIENCY						
I_{OUT}/I_{DD}	$I_{\text{LOAD}} = 2\text{ mA}$, $V_{DD} = +5\text{ V}$		93		%	

(2) Specified by design and characterization, not production tested.

(3) Specified by design and characterization, not production tested.

TIMING CHARACTERISTICS

SYMBOL	PARAMETER	TEST CONDITIONS	MIN	TYP	MAX	UNITS
f _{SCL}	SCL Clock Frequency	Standard mode			100	kHz
		Fast mode			400	kHz
		High-speed mode, C _B - 100pF max			3.4	MHz
		High-Speed mode, C _B - 400pF max			1.7	MHz
t _{BUF}	Bus Free Time Between a STOP and START Condition	Standard mode	4.7			μs
		Fast mode	1.3			μs
t _{HD} ; t _{STA}	Hold Time (Repeated) START Condition	Standard mode	4.0			μs
		Fast mode	600			ns
		High-speed mode	160			ns
t _{LOW}	LOW Period of the SCL Clock	Standard mode	4.7			μs
		Fast mode	1.3			μs
		High-speed mode, C _B - 100pF max	160			ns
		High-speed mode, C _B - 400pF max	320			ns
t _{HIGH}	HIGH Period of the SCL Clock	Standard mode	4.0			μs
		Fast mode	600			ns
		High-speed mode, C _B - 100pF max	60			ns
		High-speed mode, C _B - 400pF max	120			ns
t _{SU} ; t _{STA}	Setup Time for a Repeated START Condition	Standard mode	4.7			μs
		Fast mode	600			ns
		High-speed mode	160			ns
t _{SU} ; t _{DAT}	Data Setup Time	Standard mode	250			ns
		Fast mode	100			ns
		High-speed mode	10			ns
t _{HD} ; t _{DAT}	Data Hold Time	Standard mode	0		3.45	μs
		Fast mode	0		0.9	μs
		High-speed mode, C _B - 100pF max	0		70	ns
		High-speed mode, C _B - 400pF max	0		150	ns
t _{RCL}	Rise Time of SCL Signal	Standard mode			1000	ns
		Fast mode	20 + 0.1C _B		300	ns
		High-speed mode, C _B - 100pF max	10		40	ns
		High-speed mode, C _B - 400pF max	20		80	ns
t _{RCL1}	Rise Time of SCL Signal After a Repeated START Condition and After an Acknowledge BIT	Standard mode			1000	ns
		Fast mode	20 + 0.1C _B		300	ns
		High-speed mode, C _B - 100pF max	10		80	ns
		High-speed mode, C _B - 400pF max	20		160	ns
t _{FCL}	Fall Time of SCL Signal	Standard mode			300	ns
		Fast mode	20 + 0.1C _B		300	ns
		High-speed mode, C _B - 100pF max	10		40	ns
		High-speed mode, C _B - 400pF max	20		80	ns
t _{RDA}	Rise Time of SDA Signal	Standard mode			1000	ns
		Fast mode	20 + 0.1C _B		300	ns
		High-speed mode, C _B - 100pF max	10		80	ns
		High-speed mode, C _B - 400pF max	20		160	ns
t _{FDA}	Fall Time of SDA Signal	Standard mode			300	ns
		Fast mode	20 + 0.1C _B		300	ns
		High-speed mode, C _B - 100pF max	10		80	ns
		High-speed mode, C _B - 400pF max	20		160	ns

TIMING CHARACTERISTICS (continued)

SYMBOL	PARAMETER	TEST CONDITIONS	MIN	TYP	MAX	UNITS
t _{SU} ; t _{STO}	Setup Time for STOP Condition	Standard mode	4.0			μs
		Fast mode	600			ns
		High-speed mode	160			ns
C _B	Capacitive Load for SDA and SCL				400	pF
t _{SP}	Pulse Width of Spike Suppressed	Fast mode			50	ns
		High-speed mode			10	ns
V _{NH}	Noise Margin at the HIGH Level for Each Connected Device (Including Hysteresis)	Standard mode	0.2V _{DD}			V
		Fast mode				
		High-speed mode				
V _{NL}	Noise Margin at the LOW Level for Each Connected Device (Including Hysteresis)	Standard mode	0.1V _{DD}			V
		Fast mode				
		High-speed mode				

TYPICAL CHARACTERISTICS: $V_{DD} = +5\text{ V}$

At $T_A = +25^\circ\text{C}$, $+V_{DD} = +5\text{ V}$, unless otherwise noted.

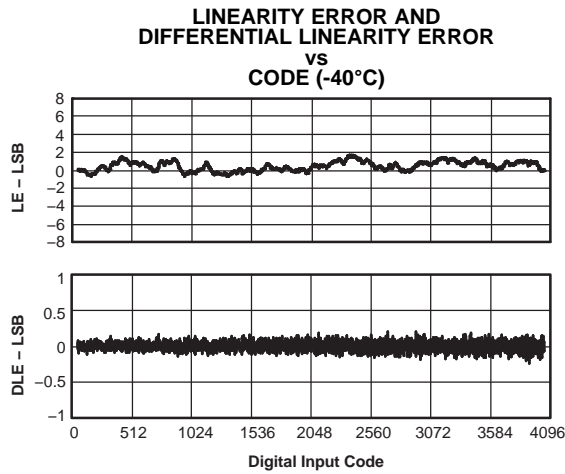

Figure 1.

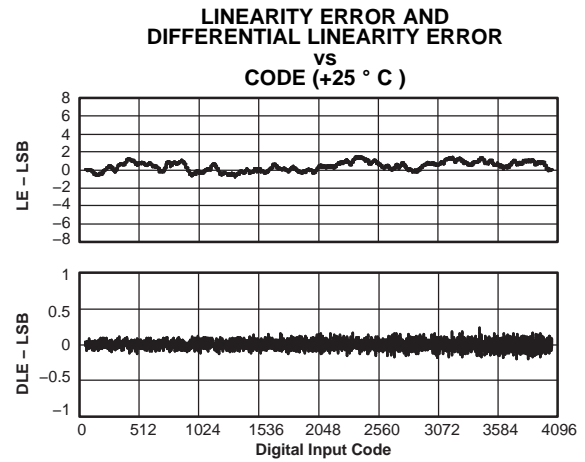

Figure 2.

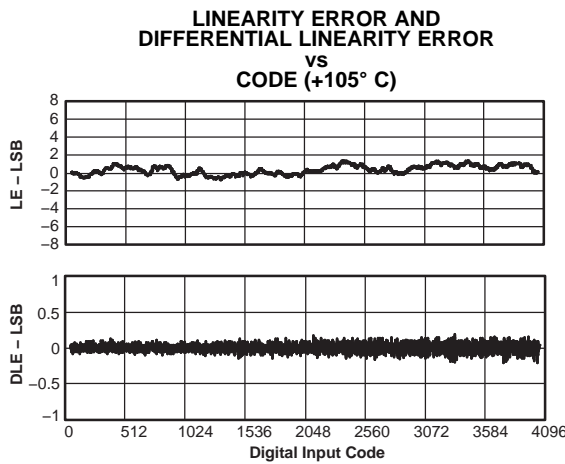

Figure 3.

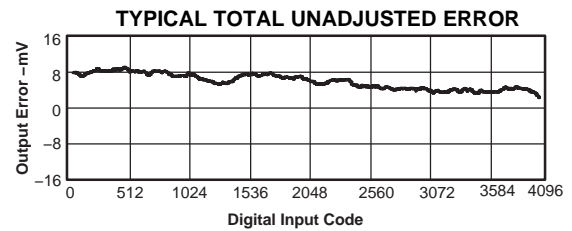

Figure 4.

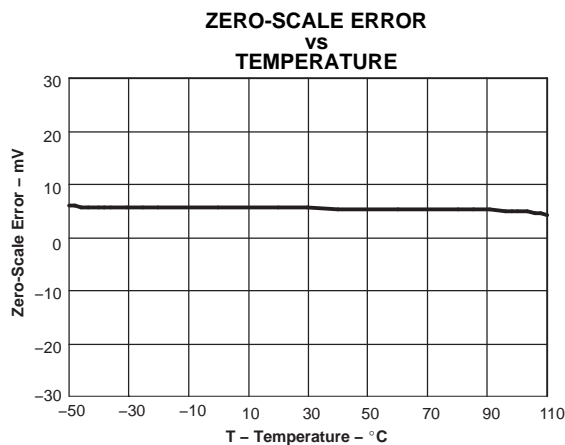

Figure 5.

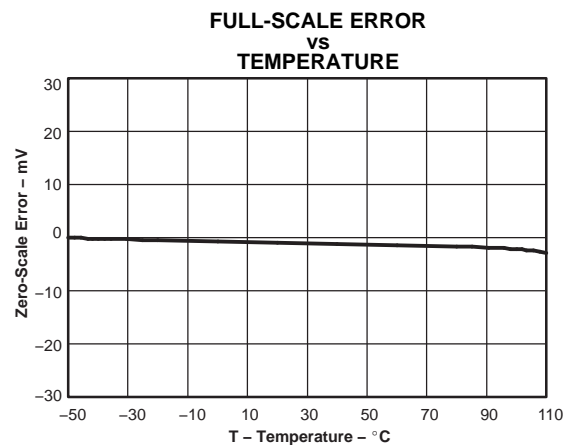

Figure 6.

TYPICAL CHARACTERISTICS: $V_{DD} = +5\text{ V}$ (continued)

At $T_A = +25^\circ\text{C}$, $+V_{DD} = +5\text{ V}$, unless otherwise noted.

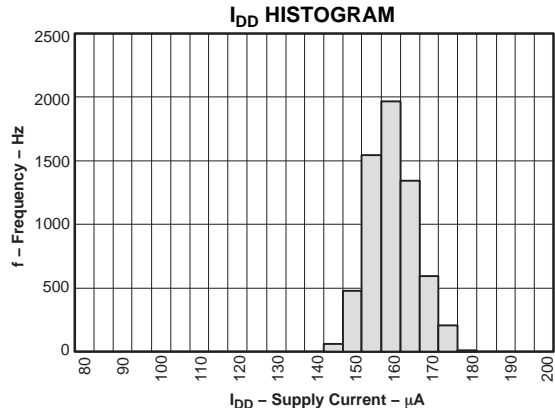

Figure 7.

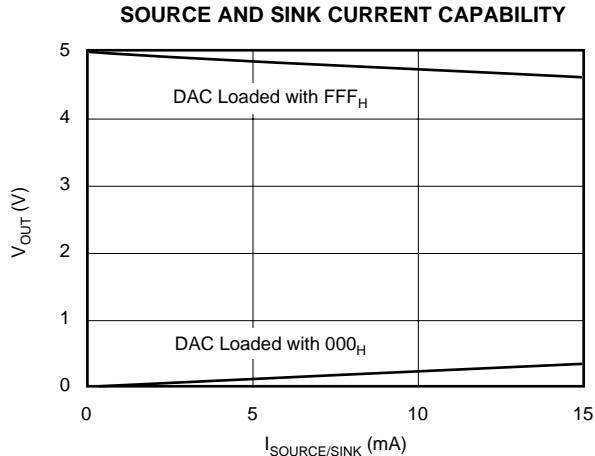

Figure 8.

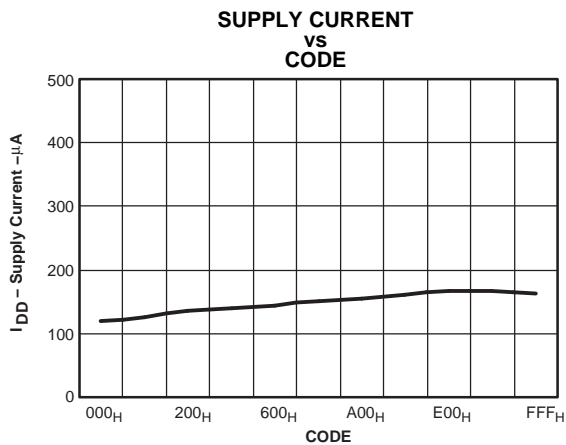

Figure 9.

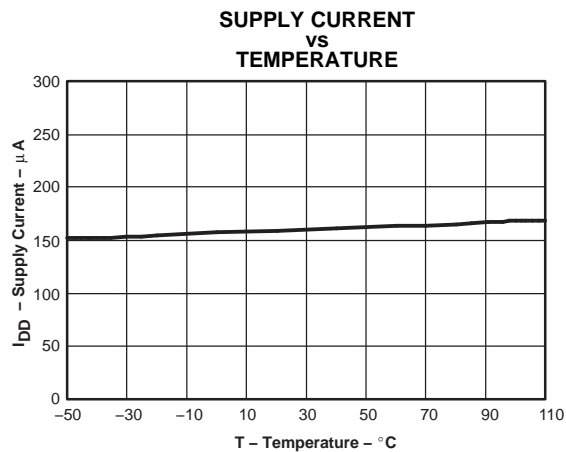

Figure 10.

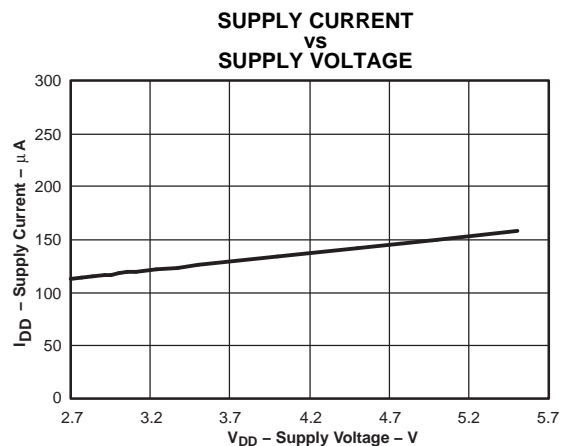

Figure 11.

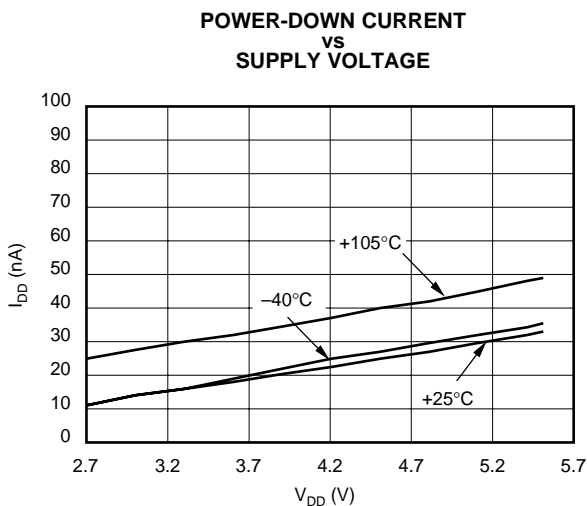

Figure 12.

TYPICAL CHARACTERISTICS: $V_{DD} = +5\text{ V}$ (continued)

At $T_A = +25^\circ\text{C}$, $+V_{DD} = +5\text{ V}$, unless otherwise noted.

**SUPPLY CURRENT
vs
LOGIC INPUT VOLTAGE**

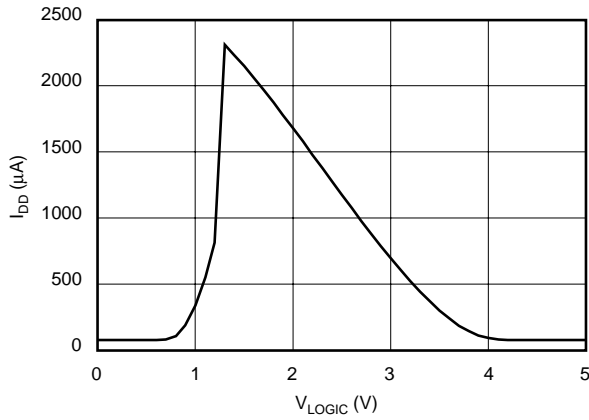

Figure 13.

FULL-SCALE SETTLING TIME

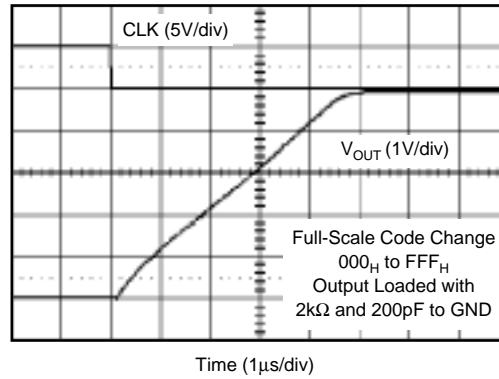

Figure 14.

FULL-SCALE SETTLING TIME

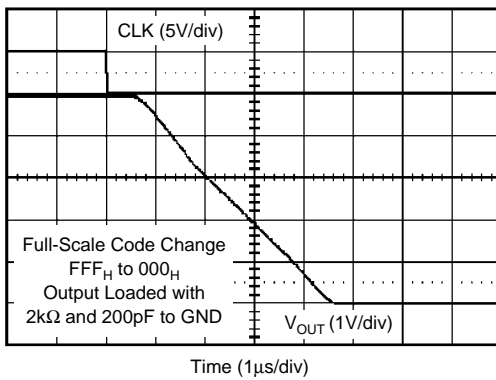

Figure 15.

HALF-SCALE SETTLING TIME

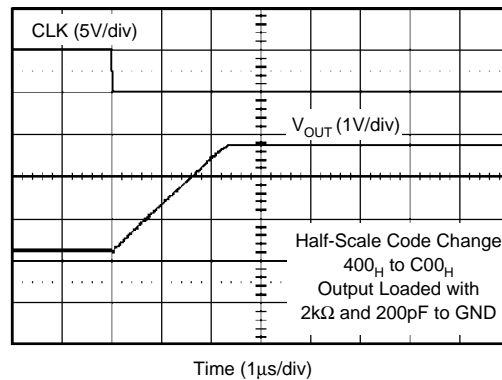

Figure 16.

HALF-SCALE SETTLING TIME

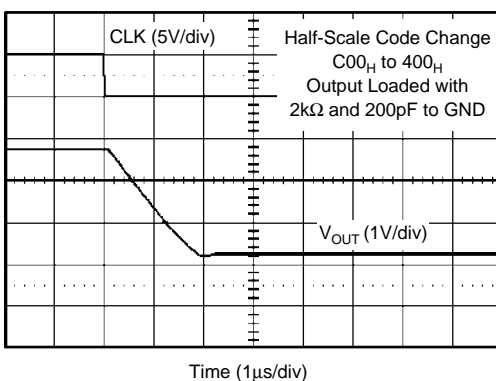

Figure 17.

POWER-ON RESET TO 0V

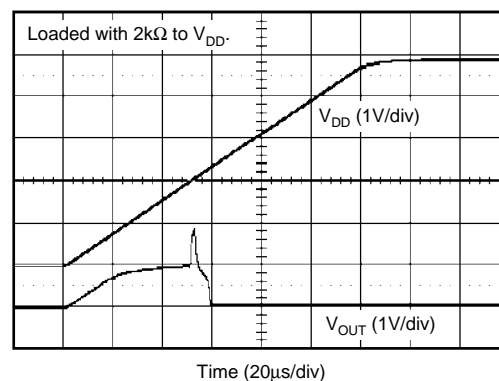

Figure 18.

TYPICAL CHARACTERISTICS: $V_{DD} = +5\text{ V}$ (continued)

At $T_A = +25^\circ\text{C}$, $+V_{DD} = +5\text{ V}$, unless otherwise noted.

**EXITING POWER-DOWN
(800 μH Loaded)**

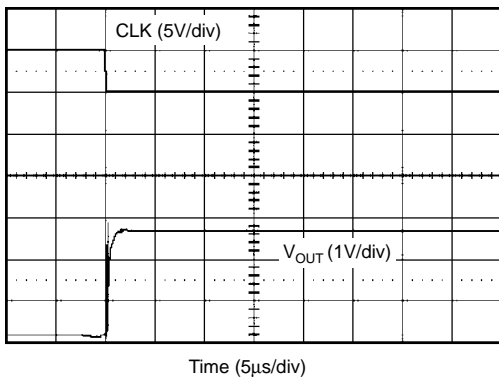

Figure 19.

CODE CHANGE GLITCH

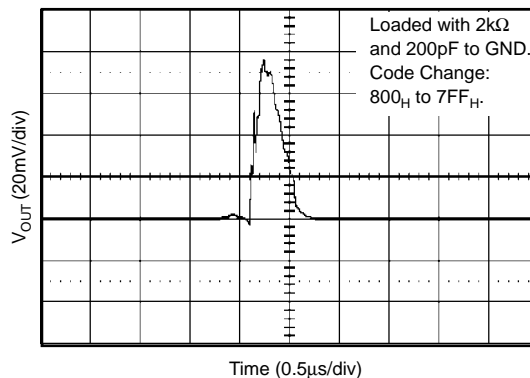

Figure 20.

TYPICAL CHARACTERISTICS: $V_{DD} = +2.7\text{ V}$

At $T_A = +25^\circ\text{C}$, $+V_{DD} = +2.7\text{V}$, unless otherwise noted.

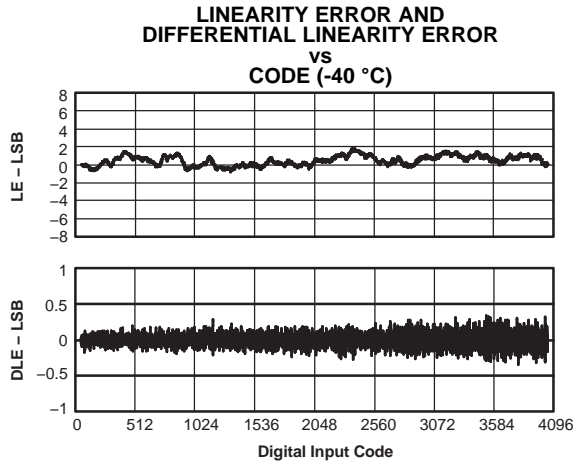

Figure 21.

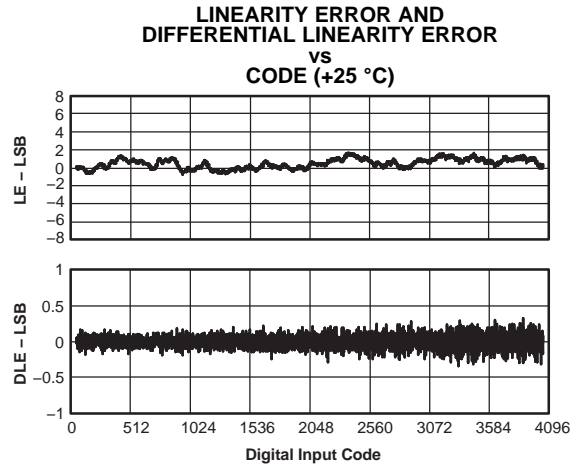

Figure 22.

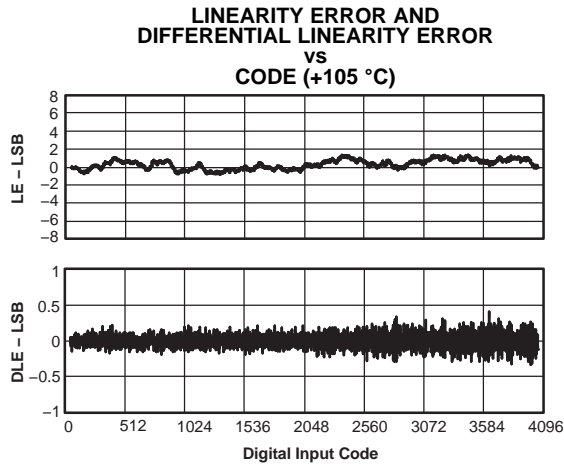

Figure 23.

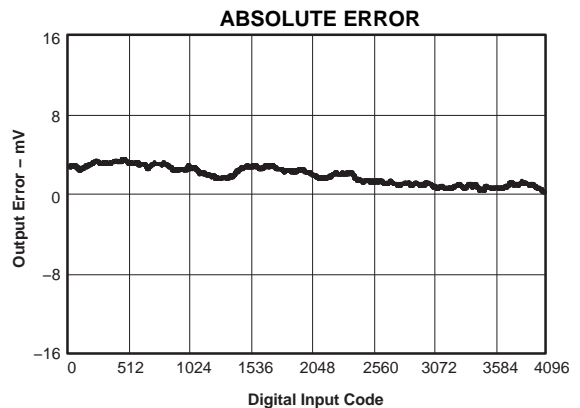

Figure 24.

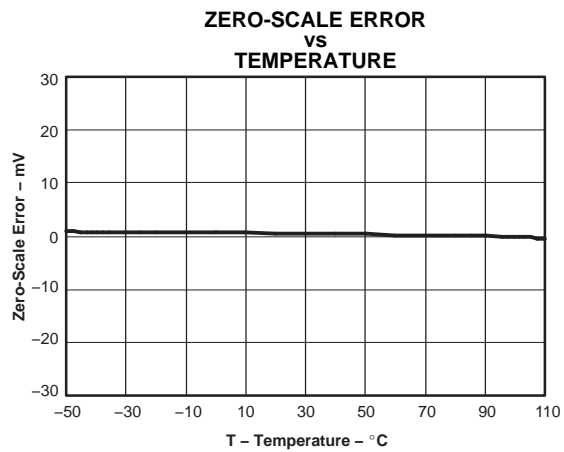

Figure 25.

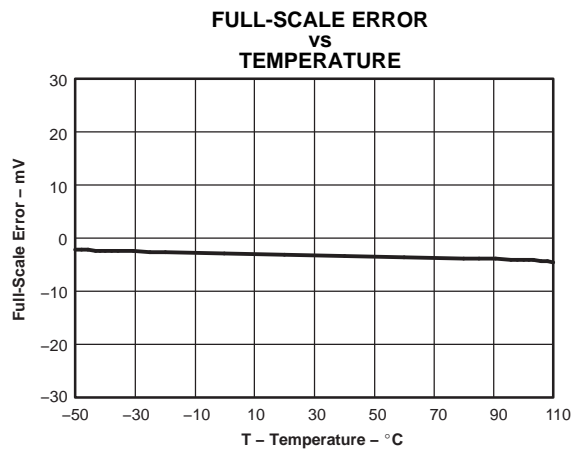

Figure 26.

TYPICAL CHARACTERISTICS: $V_{DD} = +2.7\text{ V}$ (continued)

At $T_A = +25^\circ\text{C}$, $+V_{DD} = +2.7\text{V}$, unless otherwise noted.

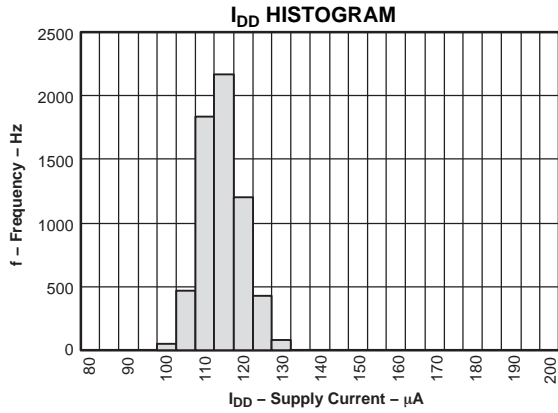

Figure 27.

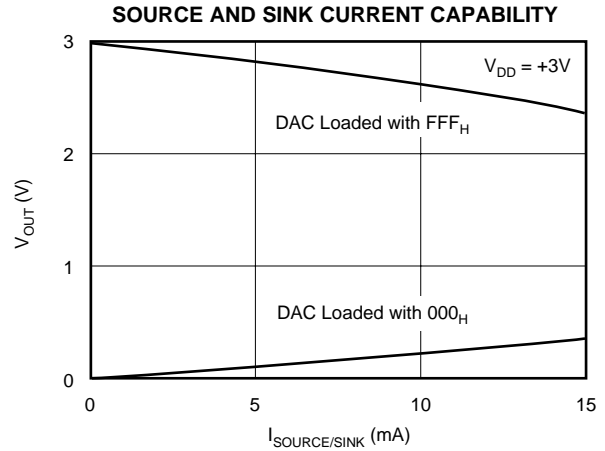

Figure 28.

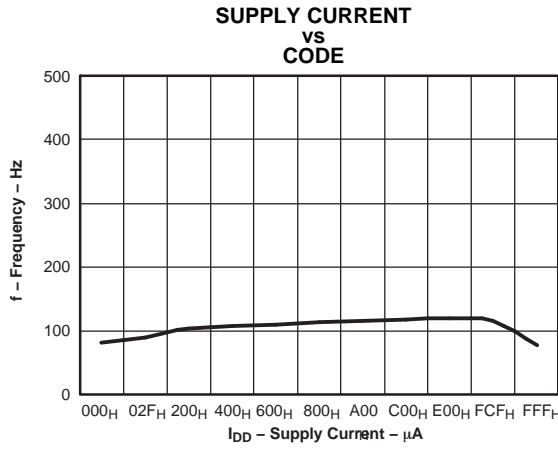

Figure 29.

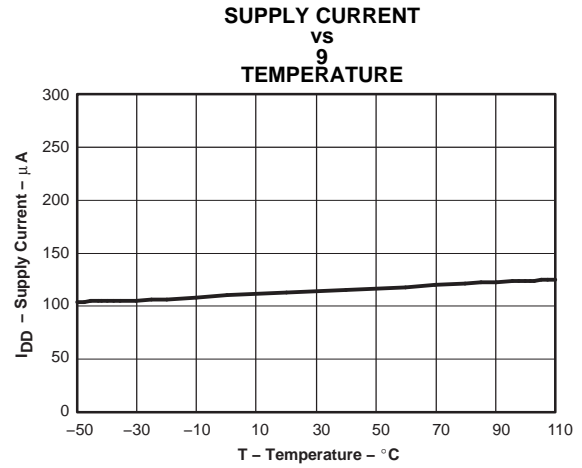

Figure 30.

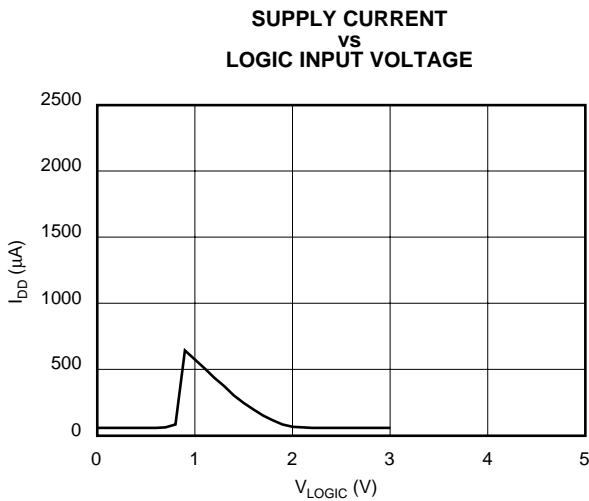

Figure 31.

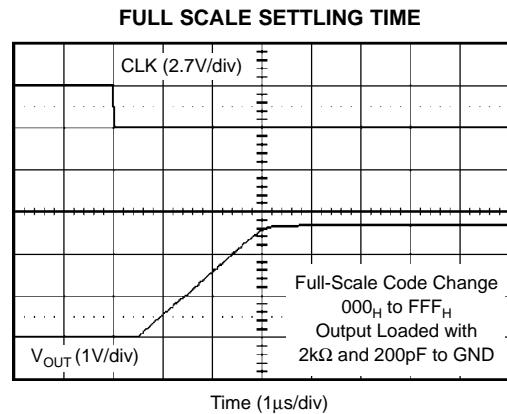

Figure 32.

TYPICAL CHARACTERISTICS: $V_{DD} = +2.7\text{ V}$ (continued)

At $T_A = +25^\circ\text{C}$, $+V_{DD} = +2.7\text{V}$, unless otherwise noted.

FULL SCALE SETTLING TIME

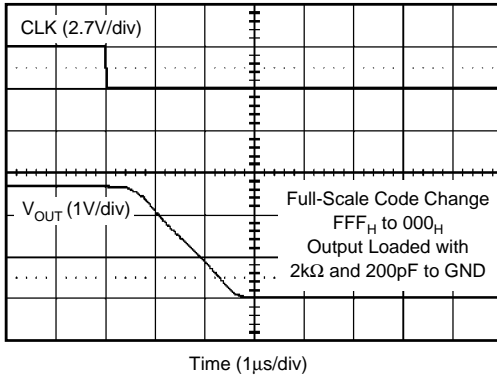

Figure 33.

HALF SCALE SETTLING TIME

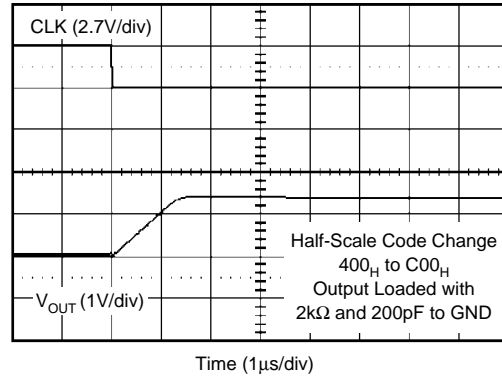

Figure 34.

HALF SCALE SETTLING TIME

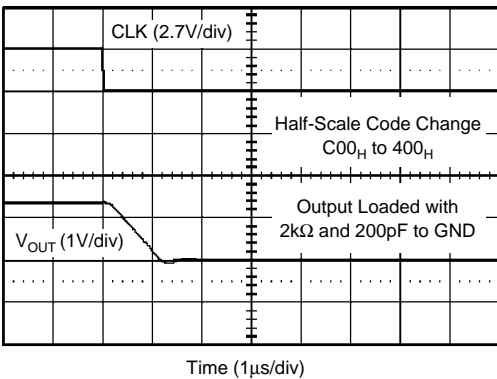

Figure 35.

POWER ON RESET 0 V

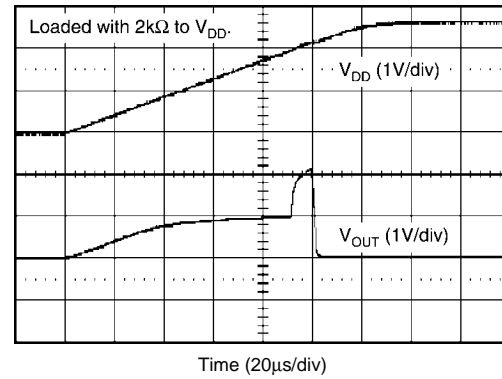

Figure 36.

EXITING-POWER DOWN (800_H Loaded)

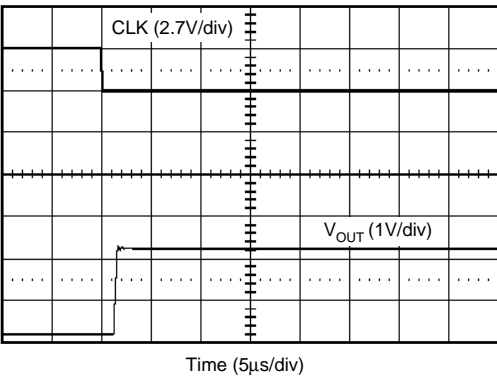

Figure 37.

CODE CHANGE GLITCH

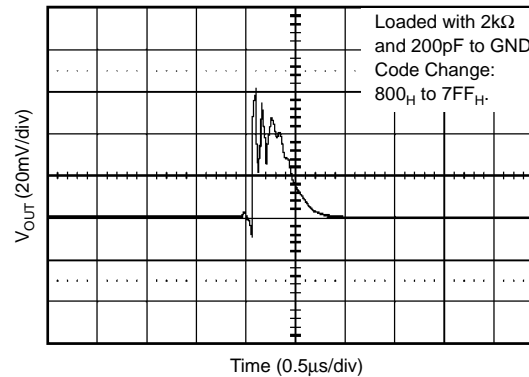

Figure 38.

THEORY OF OPERATION

D/A SECTION

The architecture of the DAC7571 consists of a string DAC followed by an output buffer amplifier. Figure 39 shows a block diagram of the DAC architecture.

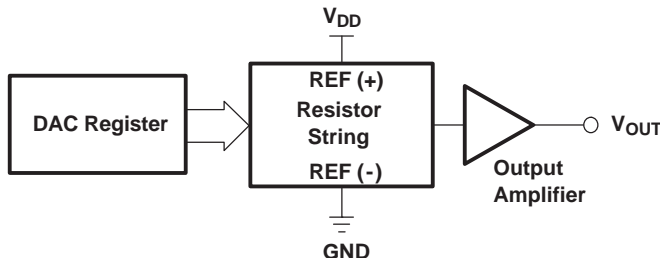

Figure 39. R-String DAC Architecture

The input coding to the DAC7571 is unsigned binary, which gives the ideal output voltage as:

$$V_{OUT} = V_{DD} \times \frac{D}{4096}$$

where D = decimal equivalent of the binary code that is loaded to the DAC register; it can range from 0 to 4095.

RESISTOR STRING

The resistor string section is shown in Figure 40. It is simply a string of resistors, each of value R. The code loaded into the DAC register determines at which node on the string the voltage is tapped off to be fed into the output amplifier by closing one of the switches connecting the string to the amplifier. It is ensured monotonic because it is a string of resistors. The negative tap of the resistor string is tied to GND. The positive tap of the resistor string is tied to V_{DD}.

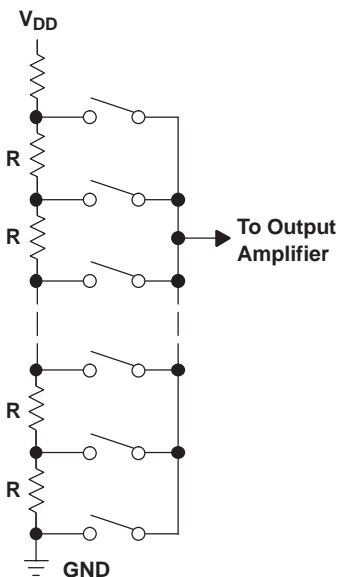

Figure 40. Resistor String

OUTPUT AMPLIFIER

The output buffer amplifier is capable of generating rail-to-rail voltages on its output which gives an output range of 0 V to V_{DD} . It is capable of driving a load of $2k\Omega$ in parallel with 1000 pF to GND. The source and sink capabilities of the output amplifier can be seen in the typical characteristics. The slew rate is $1V/\mu\text{s}$ with a half-scale settling time of $8\text{ }\mu\text{s}$ with the output unloaded.

I²C Interface

The DAC7571 uses an I²C interface as defined by Philips Semiconductor to receive data in slave mode (see I²C-Bus Specification, Version 2.1, January 2000). The DAC7571 supports the following data transfer modes, described in the I²C-Bus Specification: Standard Mode (100 kbit/s), Fast Mode (400 kbit/s) and High-Speed Mode (3.4 Mbit/s). Ten-bit addressing and general call addressing are *not* supported.

For simplicity, standard mode and fast mode are referred to as F/S-mode and high-speed mode is referred to as HS-mode.

The 2-wire I²C serial bus protocol operates as follows:

- The *Master* initiates data transfer by establishing a *Start* condition. The *Start* condition is defined when a high-to-low transition occurs on the SDA line while SCL is high, as shown in Figure 41. The byte following the start condition is the address byte consisting of the 7-bit slave address followed by the \bar{W} bit.

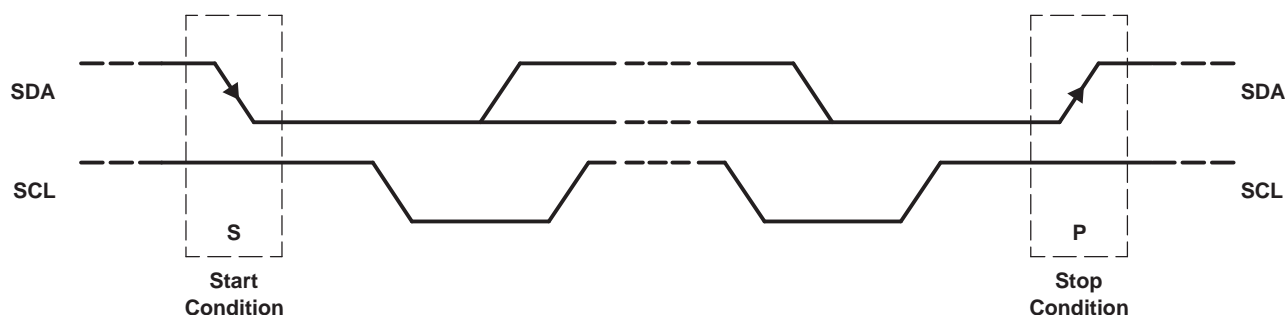

Figure 41. START and STOP Conditions

- The addressed *Slave* responds by pulling the SDA pin low during the ninth clock pulse, termed the *Acknowledge* bit (see Figure 42). At this stage all other devices on the bus remain idle while the selected device waits for data to be written to its shift register.

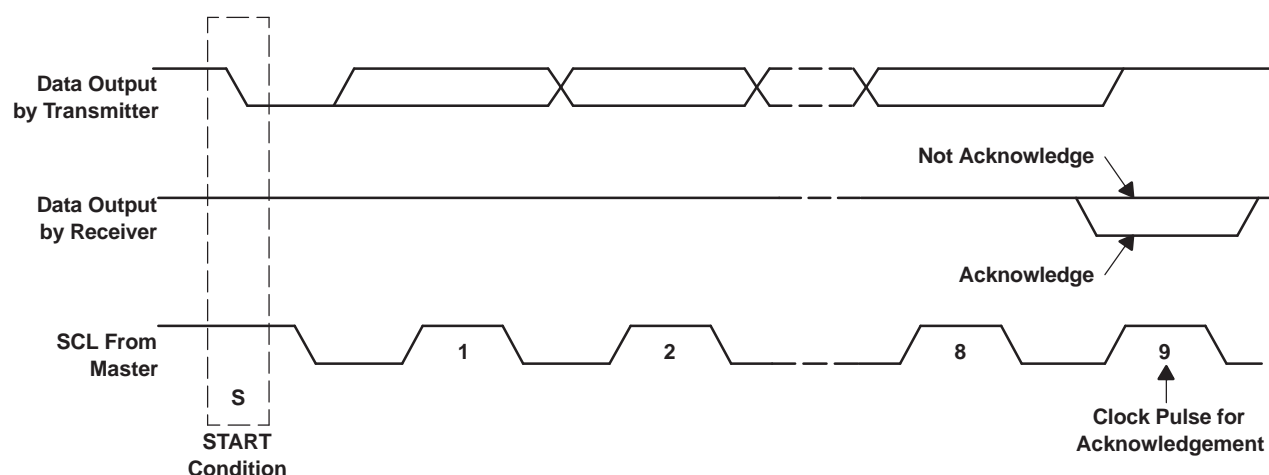

Figure 42. Acknowledge on the I²C Bus

- Data is transmitted over the serial bus in sequences of nine clock cycles (8 data bits followed by an acknowledge bit). The transitions on the SDA line must occur during the low period of SCL and remain stable during the high period of SCL (see Figure 43).

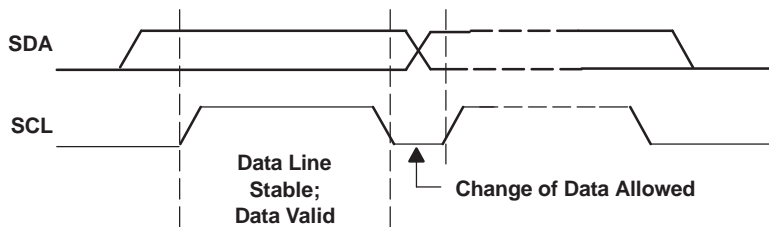

Figure 43. Bit Transfer on the I²C Bus

- When all data bits have been written, a *Stop* condition is established (see Figure 44). In writing to the DAC7571, the master must pull the SDA line high during the tenth clock pulse to establish a *Stop* condition.

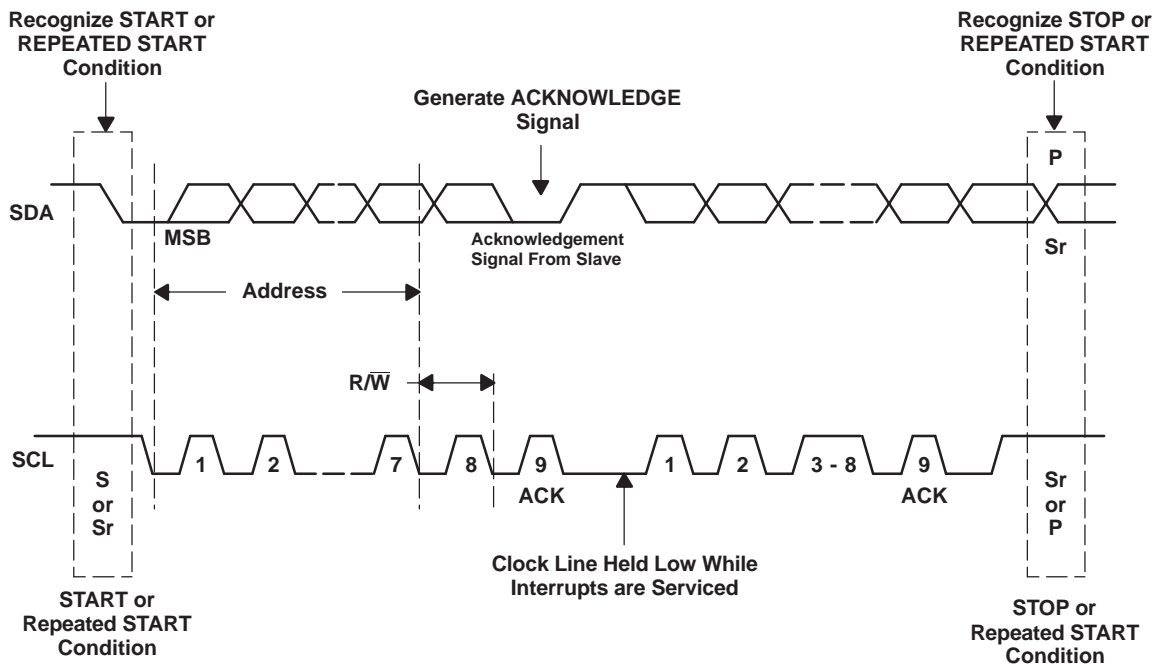
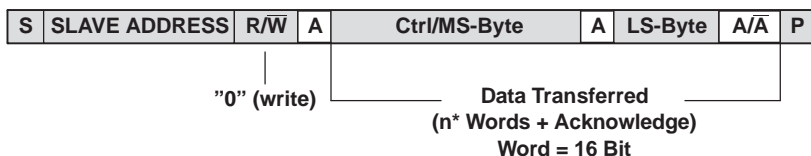

Figure 44. Bus Protocol

Standard-and Fast-Mode:



- From Master to DAC7571
- From DAC7571 to Master
- A = Acknowledge (SDA LOW)
- \bar{A} = Not Acknowledge (SDA HIGH)
- S = START Condition
- Sr = Repeated START Condition
- P = STOP Condition

DAC7571 I²C-SLAVE ADDRESS:

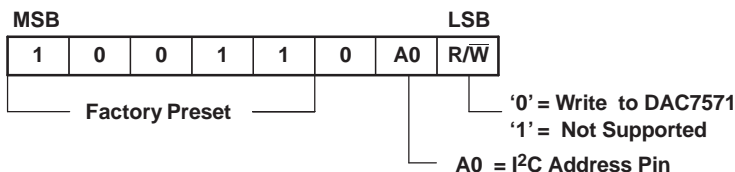

High-Speed-Mode (HS-Mode):

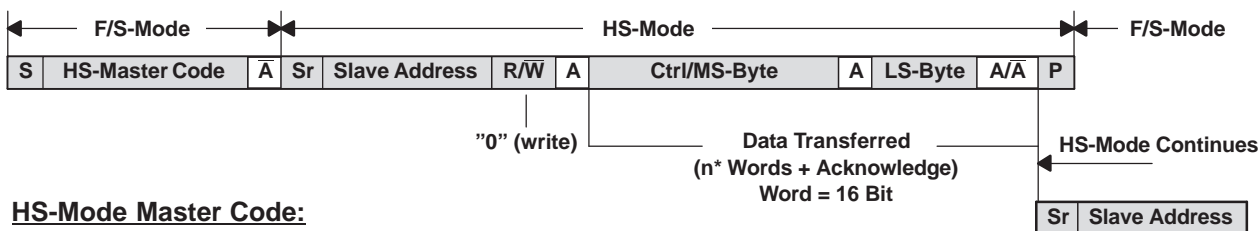

HS-Mode Master Code:

MSB								LSB
0	0	0	0	1	X	X	R/W	

Ctrl/MS-Byte:

MSB							LSB
0	0	PD1	PD2	D11	D10	D9	D8

LS-Byte:

MSB							LSB
D7	D6	D5	D4	D3	D2	D1	D0

D11 – D0 = Data Bits

Figure 45. Master Transmitter Addressing DAC7571 as a Slave Receiver With a 7-Bit Address

ADDRESS BYTE

MSB							R/W
1	0	0	1	1	0	A0	0

The address byte is the first byte received by the DAC7571 following the START condition from the master device. The first five bits (MSBs) of the slave address are factory preset to 100110. The next bit of the address byte is the device select bit, A0. In order for DAC7571 to respond, the logic state of address bit A0 should match the logic state of address pin A0. A maximum of two devices with the same preset code can therefore be connected on the same bus at one time. The A0 Address Input can be connected to V_{DD} or digital ground, or can be actively driven by TTL or CMOS logic levels. The device address is set by the state of the A0 pin upon power-up of the DAC7571. The last bit of the address byte (R/W) should always be zero (receive only I²C interface). Following the START condition, the DAC7571 monitors the SDA bus, checking the device type identifier being transmitted. Upon receiving the 100110 code, the appropriate device select bit and the R/W bit, the DAC7571 outputs an acknowledge signal on the SDA line. Upon receipt of a broadcast address 10010000, the DAC7571 responds regardless of the state of the A0 pin.

MASTER TRANSMITTER WRITING TO A SLAVE RECEIVER (DAC7571) IN STANDARD/FAST MODES

I²C protocol starts when the bus is idle, that is, when SDA and SCL lines are stable high. The master then pulls the SDA line low while SCL is still high indicating that serial data transfer has started. This is called a *start condition*, and can only be asserted by the master. After the start condition, the master generates the serial clock and puts out an address byte. While generating the bit stream, the master ensures the timing for valid data. For each valid I²C bit, the SDA line should remain stable during the entire high period of the SCL line. The address byte consists of 7 address bits (1001 100, assuming A0=0) and a direction bit ($\overline{R/\overline{W}}=0$). After sending the address byte, the master generates a ninth SCL pulse and monitors the state of the SDA line during the high period of this ninth clock cycle.

The SDA line being pulled low by a receiver during the high period of this 9th clock cycle is called an *acknowledge* signal. If the master receives an acknowledge signal, it knows that a DAC7571 successfully matched the address which the master sent. Upon the receipt of this acknowledge, the master knows that the communication link with a DAC7571 has been established and more data can be sent. The master continues by sending a Control/MS-byte, which sets DAC7571 operation mode and specifies the first 4 MSBs of data. After sending the Control/MS-byte, the master expects an acknowledge signal from the DAC7571. Upon the receipt of the acknowledge, the master sends an LS-byte that represents the 8 least significant bits of DAC7571's 12-bit conversion data. After receiving the LS-byte, the DAC7571 sends an acknowledge. At the falling edge of the acknowledge signal, following the LS-byte, the DAC7571 performs a digital to analog conversion. For further DAC updates, the master can keep repeating Control/MS-byte and LS-byte sequences expecting an acknowledge after each byte. After the required number of digital to analog conversions is complete, the master can break the communication link with the DAC7571 by pulling the SDA line from low to high while SCL line is high. This is called a *stop condition*. A stop condition brings the bus back to idle (SDA and SCL both high). A stop condition indicates that communication with the DAC7571 has ended. All devices on the bus, including the DAC7571, waits for a new start condition followed by a matching address byte. DAC7571 stays in a programmed state until the receipt of a stop condition.

Table 1. Write Sequence in Standard/Fast Modes

Transmitter	MSB	6	5	4	3	2	1	LSB	Comment
Master	Start								Begin Sequence ⁽¹⁾
Master	1	0	0	1	1	0	A0	0	Write Addressing (LSB=0, $\overline{R/\overline{W}}=0$)
DAC7571	DAC7571 Acknowledges								
Master	0	0	PD1	PD0	D11	D10	D9	D8	Writing Control/MS-Byte
DAC7571	DAC7571 Acknowledges								
Master	D7	D6	D5	D4	D3	D2	D1	D0	Writing LS-Byte
DAC7571	DAC7571 Acknowledges								
Master	Stop or Repeated Start ⁽²⁾								Done

(1) Once DAC7571 is addressed, high-byte-low-byte sequences can repeat until a stop condition is received.

(2) Use repeated start to secure bus operation and loop back to the stage of write addressing for next Write.

POWER-ON RESET

The DAC7571 contains a power-on reset circuit that controls the output voltage during power-up. On power-up, the DAC register is filled with zeros and the output voltage is 0 V. It remains at a zero-code output until a valid write sequence is made to the DAC. This is useful in applications where it is important to know the state of the DAC output while it is in the process of powering up.

POWER-DOWN MODES

The DAC7571 contains four separate modes of operation. These modes are programmable via two bits (PD1 and PD0). [Table 2](#) shows how the state of these bits correspond to the mode of operation.

Table 2. Modes of Operation for the DAC7571

PD1	PD0	OPERATING MODE
0	0	Normal Operation
0	1	1kΩ to AGND, PWD
1	0	100kΩ to AGND, PWD
1	1	High Impedance, PWD

When both bits are set to 0, the device works normally with normal power consumption of 150 μA at 5V. However, for the three power-down modes, the supply current falls to 200 nA at 5V (50 nA at 3 V). Not only does the supply current fall but the output stage is also internally switched from the output of the amplifier to a resistor network of known values. This has the advantage that the output impedance of the device is known while in power-down mode. There are three different options: The output is connected internally to AGND through a 1 k Ω resistor, a 100 k Ω resistor, or it is left open-circuited (high impedance). The output stage is illustrated in Figure 46.

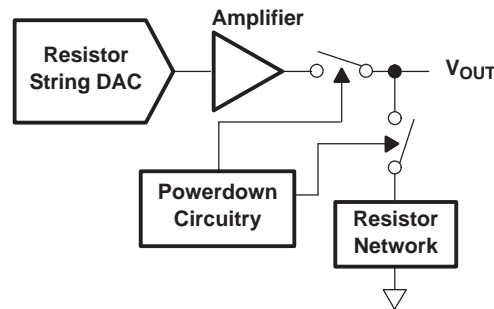
**Figure 46. Output Stage During Power-Down**

All linear circuitry is shut down when the power-down mode is activated. However, the contents of the DAC register are unaffected when in power-down. The time required to exit power down is typically 2.5 μs for $V_{DD} = 5\text{ V}$ and 5 μs for $V_{DD} = 3\text{ V}$. See the Typical Characteristics for more information.

CURRENT CONSUMPTION

The DAC7571 typically consumes 150 μA at $V_{DD} = 5\text{ V}$ and 120 μA at $V_{DD} = 3\text{ V}$. Additional current consumption can occur due to the digital inputs if $V_{IH} \ll V_{DD}$. For most efficient power operation, CMOS logic levels are recommended at the digital inputs to the DAC. In power-down mode, typical current consumption is 200 nA. Ten to 20 ms after a power-down command is issued, the power-down current typically drops below 10 mA.

DRIVING RESISTIVE AND CAPACITIVE LOADS

The DAC7571 output stage is capable of driving loads of up to 1000 pF while remaining stable. Within the offset and gain error margins, the DAC7571 can operate rail-to-rail when driving a capacitive load. Resistive loads of 2 k Ω can be driven by the DAC7571 while achieving a typical load regulation of 1%. As the load resistance drops below 2 k Ω , the load regulation error increases. When the outputs of the DAC are driven to the positive rail under resistive loading, the PMOS transistor of each Class-AB output stage can enter into the linear region. When this occurs, the added IR voltage drop deteriorates the linearity performance of the DAC. This may occur within approximately the top 20 mV of the DAC's digital input-to-voltage output transfer characteristic.

OUTPUT VOLTAGE STABILITY

The DAC7571 exhibits excellent temperature stability of 5 ppm/ $^{\circ}\text{C}$ typical output voltage drift over the specified temperature range of the device. This enables the output voltage to stay within a $\pm 25\text{ }\mu\text{V}$ window for a $\pm 1^{\circ}\text{C}$ ambient temperature change. Good power-supply rejection ratio (PSRR) performance reduces supply noise present on V_{DD} from appearing at the outputs to well below 10 μV -s. Combined with good dc noise performance and true 12-bit differential linearity, the DAC7571 becomes a perfect choice for closed-loop control applications.

APPLICATIONS

USING REF02 AS A POWER SUPPLY FOR THE DAC7571

Due to the extremely low supply current required by the DAC7571, a possible configuration is to use a REF02 +5V precision voltage reference to supply the required voltage to the DAC7571's supply input as well as the reference input, as shown in Figure 47. This is especially useful if the power supply is quite noisy or if the system supply voltages are at some value other than 5 V. The REF02 will output a steady supply voltage for the DAC7571. If the REF02 is used, the current it needs to supply to the DAC7571 is 150 μ A typical and 200 μ A max for $V_{DD} = 5$ V. When a DAC output is loaded, the REF02 also needs to supply the current to the load. The total typical current required (with a 5 mW load on a given DAC output) is: 135 μ A + (5 mW/5 V) = 1.14 mA.

The load regulation of the REF02 is typically $(0.005\% \times V_{DD})/\text{mA}$, which results in an error of 285 mV for the 1.14 mA current drawn from it. This corresponds to a 0.2 LSB error for a 0 V to 5 V output range.

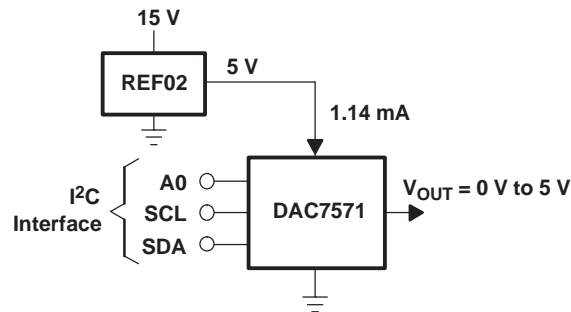

Figure 47. REF02 as Power Supply to DAC7571

LAYOUT

A precision analog component requires careful layout, adequate bypassing, and clean, well-regulated power supplies.

The power applied to V_{DD} should be well regulated and low noise. Switching power supplies and DC/DC converters will often have high-frequency glitches or spikes riding on the output voltage. In addition, digital components can create similar high-frequency spikes as their internal logic switches states. This noise can easily couple into the DAC output voltage through various paths between the power connections and analog output.

As with the GND connection, V_{DD} should be connected to a +5 V power supply plane or trace that is separate from the connection for digital logic until they are connected at the power entry point. In addition, the 1 μ F to 10 μ F and 0.1 μ F bypass capacitors are strongly recommended. In some situations, additional bypassing may be required, such as a 100 μ F electrolytic capacitor or even a Pi filter made up of inductors and capacitors—all designed to essentially low-pass filter the +5 V supply, removing the high-frequency noise.

REVISION HISTORY

NOTE: Page numbers of current version may differ from previous versions.

Changes from Revision C (May 2006) to Revision D	Page
• Corrected several typographical errors in the Theory of Operation section.	14

PACKAGING INFORMATION

Orderable Device	Status (1)	Package Type	Package Drawing	Pins	Package Qty	Eco Plan (2)	Lead finish/ Ball material (6)	MSL Peak Temp (3)	Op Temp (°C)	Device Marking (4/5)	Samples
DAC7571IDBVR	ACTIVE	SOT-23	DBV	6	3000	RoHS & Green	NIPDAU	Level-1-260C-UNLIM	-40 to 105	D771	Samples
DAC7571IDBVT	ACTIVE	SOT-23	DBV	6	250	RoHS & Green	NIPDAU	Level-1-260C-UNLIM	-40 to 105	D771	Samples
DAC7571IDBVTG4	ACTIVE	SOT-23	DBV	6	250	RoHS & Green	NIPDAU	Level-1-260C-UNLIM	-40 to 105	D771	Samples

(1) The marketing status values are defined as follows:

ACTIVE: Product device recommended for new designs.

LIFEBUY: TI has announced that the device will be discontinued, and a lifetime-buy period is in effect.

NRND: Not recommended for new designs. Device is in production to support existing customers, but TI does not recommend using this part in a new design.

PREVIEW: Device has been announced but is not in production. Samples may or may not be available.

OBSOLETE: TI has discontinued the production of the device.

(2) **RoHS:** TI defines "RoHS" to mean semiconductor products that are compliant with the current EU RoHS requirements for all 10 RoHS substances, including the requirement that RoHS substance do not exceed 0.1% by weight in homogeneous materials. Where designed to be soldered at high temperatures, "RoHS" products are suitable for use in specified lead-free processes. TI may reference these types of products as "Pb-Free".

RoHS Exempt: TI defines "RoHS Exempt" to mean products that contain lead but are compliant with EU RoHS pursuant to a specific EU RoHS exemption.

Green: TI defines "Green" to mean the content of Chlorine (Cl) and Bromine (Br) based flame retardants meet JS709B low halogen requirements of <=1000ppm threshold. Antimony trioxide based flame retardants must also meet the <=1000ppm threshold requirement.

(3) MSL, Peak Temp. - The Moisture Sensitivity Level rating according to the JEDEC industry standard classifications, and peak solder temperature.

(4) There may be additional marking, which relates to the logo, the lot trace code information, or the environmental category on the device.

(5) Multiple Device Markings will be inside parentheses. Only one Device Marking contained in parentheses and separated by a "~" will appear on a device. If a line is indented then it is a continuation of the previous line and the two combined represent the entire Device Marking for that device.

(6) Lead finish/Ball material - Orderable Devices may have multiple material finish options. Finish options are separated by a vertical ruled line. Lead finish/Ball material values may wrap to two lines if the finish value exceeds the maximum column width.

Important Information and Disclaimer:The information provided on this page represents TI's knowledge and belief as of the date that it is provided. TI bases its knowledge and belief on information provided by third parties, and makes no representation or warranty as to the accuracy of such information. Efforts are underway to better integrate information from third parties. TI has taken and continues to take reasonable steps to provide representative and accurate information but may not have conducted destructive testing or chemical analysis on incoming materials and chemicals. TI and TI suppliers consider certain information to be proprietary, and thus CAS numbers and other limited information may not be available for release.

In no event shall TI's liability arising out of such information exceed the total purchase price of the TI part(s) at issue in this document sold by TI to Customer on an annual basis.

TAPE AND REEL INFORMATION

QUADRANT ASSIGNMENTS FOR PIN 1 ORIENTATION IN TAPE

*All dimensions are nominal

Device	Package Type	Package Drawing	Pins	SPQ	Reel Diameter (mm)	Reel Width W1 (mm)	A0 (mm)	B0 (mm)	K0 (mm)	P1 (mm)	W (mm)	Pin1 Quadrant
DAC7571IDBVR	SOT-23	DBV	6	3000	178.0	9.0	3.23	3.17	1.37	4.0	8.0	Q3
DAC7571IDBVT	SOT-23	DBV	6	250	178.0	9.0	3.23	3.17	1.37	4.0	8.0	Q3

TAPE AND REEL BOX DIMENSIONS

*All dimensions are nominal

Device	Package Type	Package Drawing	Pins	SPQ	Length (mm)	Width (mm)	Height (mm)
DAC7571IDBVR	SOT-23	DBV	6	3000	180.0	180.0	18.0
DAC7571IDBVT	SOT-23	DBV	6	250	180.0	180.0	18.0

DBV0006A



PACKAGE OUTLINE

SOT-23 - 1.45 mm max height

SMALL OUTLINE TRANSISTOR

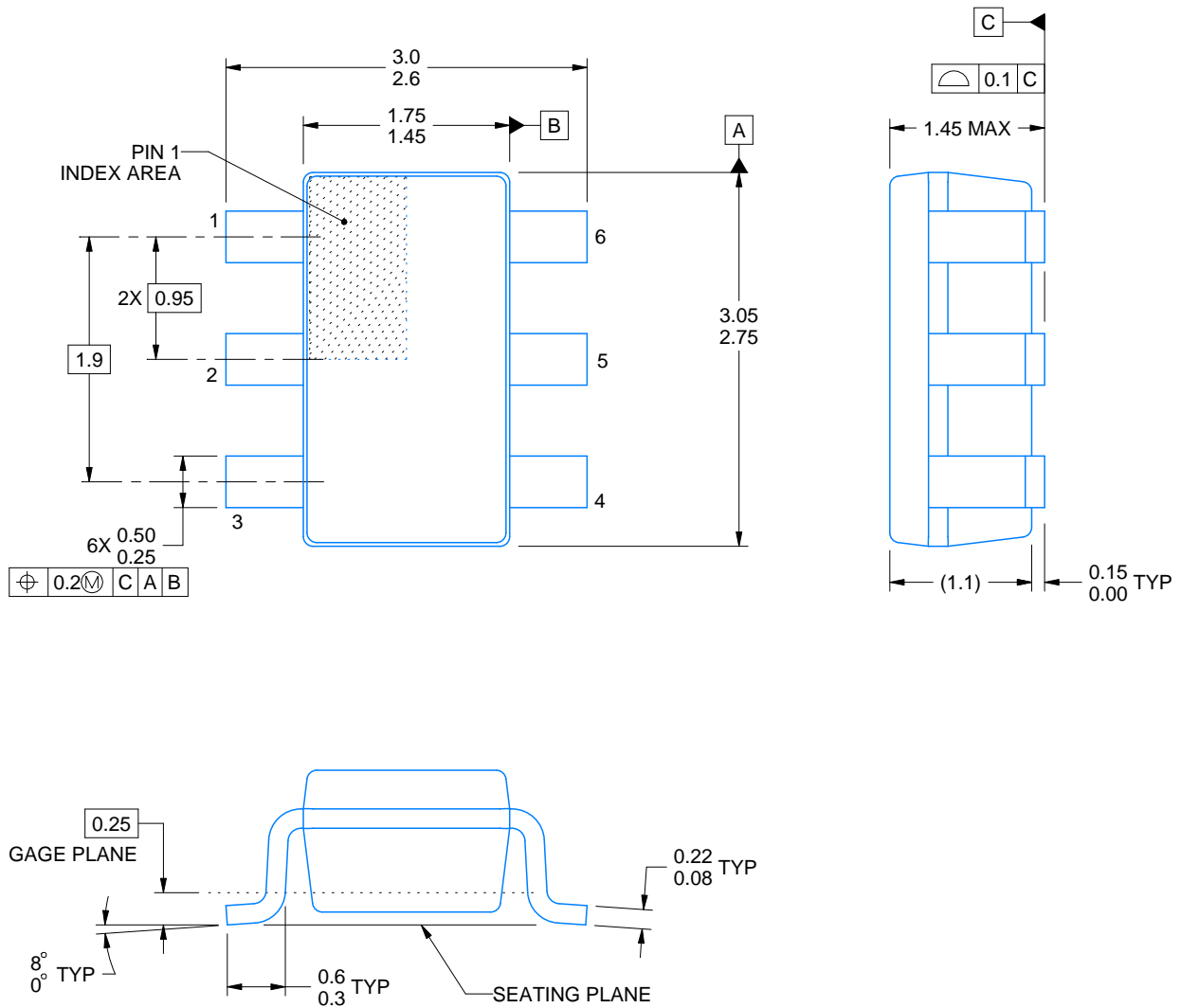

4214840/B 03/2018

NOTES:

1. All linear dimensions are in millimeters. Any dimensions in parenthesis are for reference only. Dimensioning and tolerancing per ASME Y14.5M.
2. This drawing is subject to change without notice.
3. Body dimensions do not include mold flash or protrusion. Mold flash and protrusion shall not exceed 0.15 per side.
4. Leads 1,2,3 may be wider than leads 4,5,6 for package orientation.
5. Reference JEDEC MO-178.

EXAMPLE BOARD LAYOUT

DBV0006A

SOT-23 - 1.45 mm max height

SMALL OUTLINE TRANSISTOR



LAND PATTERN EXAMPLE
EXPOSED METAL SHOWN
SCALE:15X

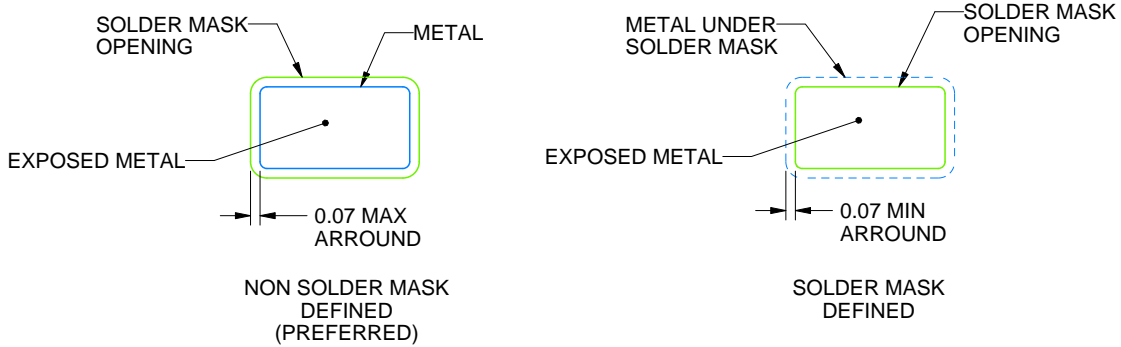

SOLDER MASK DETAILS

4214840/B 03/2018

NOTES: (continued)

6. Publication IPC-7351 may have alternate designs.

7. Solder mask tolerances between and around signal pads can vary based on board fabrication site.

EXAMPLE STENCIL DESIGN

DBV0006A

SOT-23 - 1.45 mm max height

SMALL OUTLINE TRANSISTOR



SOLDER PASTE EXAMPLE
BASED ON 0.125 mm THICK STENCIL
SCALE:15X

4214840/B 03/2018

NOTES: (continued)

8. Laser cutting apertures with trapezoidal walls and rounded corners may offer better paste release. IPC-7525 may have alternate design recommendations.
9. Board assembly site may have different recommendations for stencil design.

IMPORTANT NOTICE AND DISCLAIMER

TI PROVIDES TECHNICAL AND RELIABILITY DATA (INCLUDING DATASHEETS), DESIGN RESOURCES (INCLUDING REFERENCE DESIGNS), APPLICATION OR OTHER DESIGN ADVICE, WEB TOOLS, SAFETY INFORMATION, AND OTHER RESOURCES "AS IS" AND WITH ALL FAULTS, AND DISCLAIMS ALL WARRANTIES, EXPRESS AND IMPLIED, INCLUDING WITHOUT LIMITATION ANY IMPLIED WARRANTIES OF MERCHANTABILITY, FITNESS FOR A PARTICULAR PURPOSE OR NON-INFRINGEMENT OF THIRD PARTY INTELLECTUAL PROPERTY RIGHTS.

These resources are intended for skilled developers designing with TI products. You are solely responsible for (1) selecting the appropriate TI products for your application, (2) designing, validating and testing your application, and (3) ensuring your application meets applicable standards, and any other safety, security, or other requirements. These resources are subject to change without notice. TI grants you permission to use these resources only for development of an application that uses the TI products described in the resource. Other reproduction and display of these resources is prohibited. No license is granted to any other TI intellectual property right or to any third party intellectual property right. TI disclaims responsibility for, and you will fully indemnify TI and its representatives against, any claims, damages, costs, losses, and liabilities arising out of your use of these resources.

TI's products are provided subject to TI's Terms of Sale (www.ti.com/legal/termsofsale.html) or other applicable terms available either on ti.com or provided in conjunction with such TI products. TI's provision of these resources does not expand or otherwise alter TI's applicable warranties or warranty disclaimers for TI products.

Mailing Address: Texas Instruments, Post Office Box 655303, Dallas, Texas 75265
Copyright © 2020, Texas Instruments Incorporated