

LM4030 SOT-23 Ultra-High Precision Shunt Voltage Reference

Check for Samples: [LM4030](#)

FEATURES

- High Output Voltage Accuracy 0.05%
- Low Temperature Coefficient 10 ppm/°C
- Extended Temperature Operation -40-125°C
- Excellent Thermal Hysteresis, 75ppm
- Excellent Long-Term Stability, 40ppm
- High Immunity to Board Stress Effects
- Capable of Handling 50 mA Transients
- Voltage Options 2.5V, 4.096V
- SOT-23 Package

APPLICATIONS

- Data Acquisition/Signal path
- Test and Measurement
- Automotive & Industrial
- Communications
- Instrumentation
- Power Management

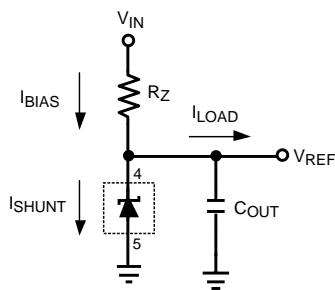
DESCRIPTION

The LM4030 is an ultra-high precision shunt voltage reference, having exceptionally high initial accuracy (0.05%) and temperature stability (10ppm/°C). The LM4030 is available with fixed voltage options of 2.5V and 4.096V. Despite the tiny SOT-23 package, the LM4030 exhibits excellent thermal hysteresis (75ppm) and long-term stability (40ppm) as well as immunity to board stress effects.

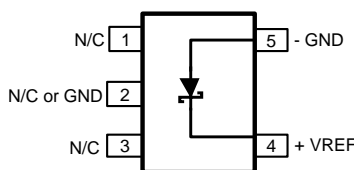
The LM4030 is designed to operate without an external capacitor, but any capacitor up to 10μF may be used. The LM4030 can be powered off as little as 120μA (max) but is capable of shunting up to 30mA continuously. As with any shunt reference, the LM4030 can be powered off of virtually any supply and is a simple way to generate a highly accurate system reference.

The LM4030 is available in three grades (A, B, and C). The best grade devices (A) have an initial accuracy of 0.05% with ensured temperature coefficient of 10 ppm/°C or less, while the lowest grade parts (C) have an initial accuracy of 0.15% and a temperature coefficient of 30 ppm/°C.

Typical Application Circuit



Connection Diagram



**SOT-23 Package
(Top View)**



Please be aware that an important notice concerning availability, standard warranty, and use in critical applications of Texas Instruments semiconductor products and disclaimers thereto appears at the end of this data sheet.

All trademarks are the property of their respective owners.

PIN DESCRIPTIONS

Pin #	Name	Function
1	N/C	No connect pin, leave floating
2	GND, N/C	Ground or no connect
3	N/C	No connect pin, leave floating
4	VREF	Reference voltsge
5	GND	Ground



These devices have limited built-in ESD protection. The leads should be shorted together or the device placed in conductive foam during storage or handling to prevent electrostatic damage to the MOS gates.

Absolute Maximum Ratings ⁽¹⁾⁽²⁾

Maximum Voltage on any input	-0.3 to 6V
Power Dissipation ($T_A = 25^\circ\text{C}$) ⁽³⁾	350mW
Storage Temperature Range	-65°C to 150°C
Lead Temperature (soldering, 10sec)	260°C
Vapor Phase (60 sec)	215°C
Infrared (15sec)	220°C
ESD Susceptibility ⁽⁴⁾ Human Body Model	2kV

- (1) Absolute Maximum Ratings indicate limits beyond which damage may occur to the device. Operating Ratings indicate conditions for which the device is intended to be functional, but do not ensure specific performance limits. For ensured specifications, see Electrical Characteristics.
- (2) If Military/Aerospace specified devices are required, please contact the Texas Instruments Sales Office/ Distributors for availability and specifications.
- (3) Without PCB copper enhancements. The maximum power dissipation must be de-rated at elevated temperatures and is limited by T_{JMAX} (maximum junction temperature), θ_{J-A} (junction to ambient thermal resistance) and T_A (ambient temperature). The maximum power dissipation at any temperature is: $P_{DissMAX} = (T_{JMAX} - T_A) / \theta_{J-A}$ up to the value listed in the Absolute Maximum Ratings. θ_{J-A} for SOT-23 package is $220^\circ\text{C}/\text{W}$, $T_{JMAX} = 125^\circ\text{C}$.
- (4) The human body model is a 100 pF capacitor discharged through a 1.5 k Ω resistor into each pin.

Operating Ratings

Maximum Continuous Shunt Current	30mA
Maximum Shunt Current (<1s)	50mA
Junction Temperature Range (T_J)	-40°C to $+125^\circ\text{C}$

Electrical Characteristics LM4030-2.5 (V_{OUT} = 2.5V)

Limits in standard type are for T_J = 25°C only, and limits in boldface type apply over the junction temperature (T_J) range of -40°C to +125°C. Minimum and Maximum limits are ensured through test, design, or statistical correlation. Typical values represent the most likely parametric norm at T_J = 25°C, and are provided for reference purposes only.

Symbol	Parameter	Conditions	Min ⁽¹⁾	Typ ⁽²⁾	Max ⁽¹⁾	Unit
V _{REF}	Reverse Breakdown Voltage	I _{SHUNT} = 120μA		2.5		V
	Reverse Breakdown Voltage Tolerance (I _{SHUNT} = 120μA)					
	LM4030A-2.5	(A Grade - 0.05%)	-0.05		0.05	%
	LM4030B-2.5	(B Grade - 0.10%)	-0.10		0.10	%
	LM4030C-2.5	(C Grade - 0.15%)	-0.15		0.15	%
I _{RMIN}	Minimum Operating Current				120	μA
TC	Temperature Coefficient ⁽³⁾					
	LM4030A-2.5	0°C ≤ T _J ≤ +85°C			10	ppm / °C
		-40°C ≤ T _J ≤ +125°C			20	ppm / °C
	LM4030B-2.5	-40°C ≤ T _J ≤ +125°C			20	ppm / °C
	LM4030C-2.5	-40°C ≤ T _J ≤ +125°C			30	ppm / °C
ΔV _{REF} /ΔI _{SHUNT}	Reverse Breakdown Voltage Change with Current	160μA ≤ I _{SHUNT} ≤ 30mA		25	110	ppm / mA
ΔV _{REF}	Long Term Stability ⁽⁴⁾	1000 Hrs, T _A = 30°C		40		ppm
V _{HYST}	Thermal Hysteresis ⁽⁵⁾	-40°C ≤ T _J ≤ +125°C		75		ppm
V _N	Output Noise Voltage ⁽⁶⁾	0.1 Hz to 10 Hz		105		μV _{PP}

- (1) Limits are 100% production tested at 25°C. Limits over the operating temperature range are ensured through correlation using Statistical Quality Control.
- (2) Typical numbers are at 25°C and represent the most likely parametric norm.
- (3) Temperature coefficient is measured by the "Box" method; i.e., the maximum ΔV_{REF} is divided by the maximum ΔT.
- (4) Long term stability is V_{REF} @25°C measured during 1000 hrs. This measurement is taken for I_R = 500 μA.
- (5) Thermal hysteresis is defined as the change in +25°C output voltage before and after cycling the device from (-40°C to 125°C) eight times.
- (6) Low frequency peak-to-peak noise measured using first-order 0.1 Hz HPF and second-order 10 Hz LPF.

Electrical Characteristics LM4030-4.096 (V_{OUT} = 4.096V)

Limits in standard type are for T_J = 25°C only, and limits in boldface type apply over the junction temperature (T_J) range of -40°C to +125°C. Minimum and Maximum limits are ensured through test, design, or statistical correlation. Typical values represent the most likely parametric norm at T_J = 25°C, and are provided for reference purposes only.

Symbol	Parameter	Conditions	Min ⁽¹⁾	Typ ⁽²⁾	Max ⁽¹⁾	Unit
V _{REF}	Reverse Breakdown Voltage	I _{SHUNT} = 130μA		4.096		V
	Reverse Breakdown Voltage Tolerance (I _{SHUNT} = 130μA)					
	LM4030A-4.096	(A Grade - 0.05%)	-0.05		0.05	%
	LM4030B-4.096	(B Grade - 0.10%)	-0.10		0.10	%
	LM4030C-4.096	(C Grade - 0.15%)	-0.15		0.15	%
I _{RMIN}	Minimum Operating Current				130	μA
TC	Temperature Coefficient ⁽³⁾					
	LM4030A-4.096	0°C ≤ T _J ≤ +85°C			10	ppm / °C
		-40°C ≤ T _J ≤ +125°C			20	ppm / °C
	LM4030B-4.096	-40°C ≤ T _J ≤ +125°C			20	ppm / °C
	LM4030C-4.096	-40°C ≤ T _J ≤ +125°C			30	ppm / °C
ΔV _{REF} /ΔI _{LOAD}	Reverse Breakdown Voltage Change with Current	160μA ≤ I _{SHUNT} ≤ 30mA		15	95	ppm / mA

- (1) Limits are 100% production tested at 25°C. Limits over the operating temperature range are ensured through correlation using Statistical Quality Control.
- (2) Typical numbers are at 25°C and represent the most likely parametric norm.
- (3) Temperature coefficient is measured by the "Box" method; i.e., the maximum ΔV_{REF} is divided by the maximum ΔT.

Electrical Characteristics

LM4030-4.096 ($V_{OUT} = 4.096V$) (continued)

Limits in standard type are for $T_J = 25^\circ C$ only, and limits in boldface type apply over the junction temperature (T_J) range of $-40^\circ C$ to $+125^\circ C$. Minimum and Maximum limits are ensured through test, design, or statistical correlation. Typical values represent the most likely parametric norm at $T_J = 25^\circ C$, and are provided for reference purposes only.

Symbol	Parameter	Conditions	Min ⁽¹⁾	Typ ⁽²⁾	Max ⁽¹⁾	Unit
ΔV_{REF}	Long Term Stability ⁽⁴⁾	1000 Hrs, $T_A = 30^\circ C$		40		ppm
V_{HYST}	Thermal Hysteresis ⁽⁵⁾	$-40^\circ C \leq T_J \leq +125^\circ C$		75		ppm
V_N	Output Noise Voltage ⁽⁶⁾	0.1 Hz to 10 Hz		165		μV_{PP}

(4) Long term stability is V_{REF} @ $25^\circ C$ measured during 1000 hrs. This measurement is taken for $I_R = 500 \mu A$.

(5) Thermal hysteresis is defined as the change in $+25^\circ C$ output voltage before and after cycling the device from $(-40^\circ C$ to $125^\circ C)$ eight times.

(6) Low frequency peak-to-peak noise measured using first-order 0.1 Hz HPF and second-order 10 Hz LPF.

Typical Performance Characteristics for 2.5V

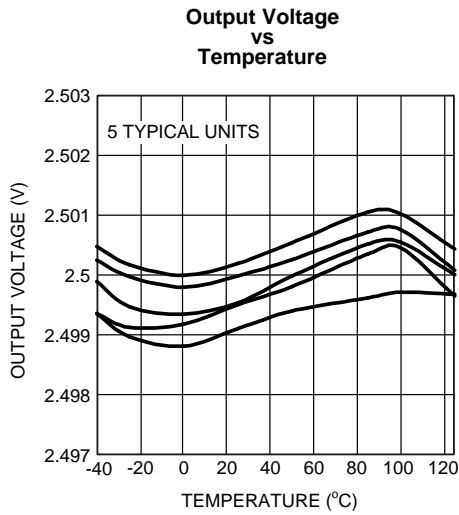


Figure 1.

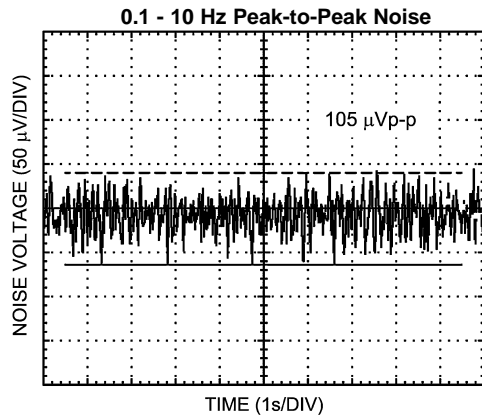


Figure 2.

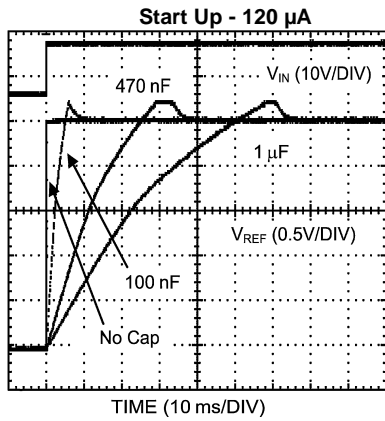


Figure 3.

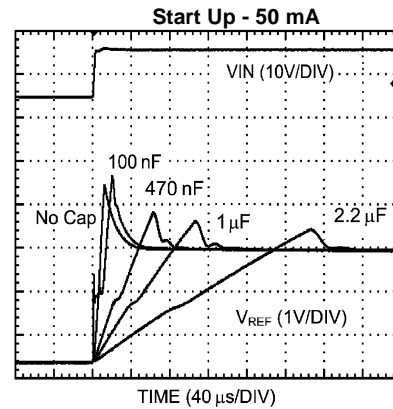


Figure 4.

Reverse Breakdown Voltage Change with Current

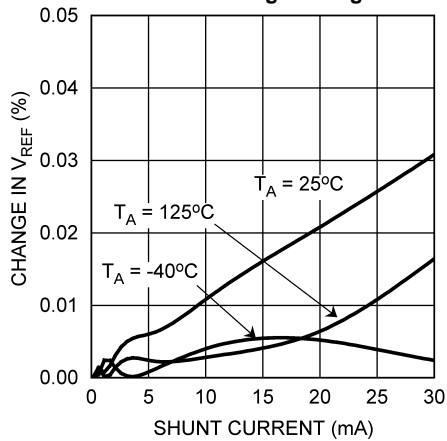


Figure 5.

Reverse Dynamic Impedance vs Frequency

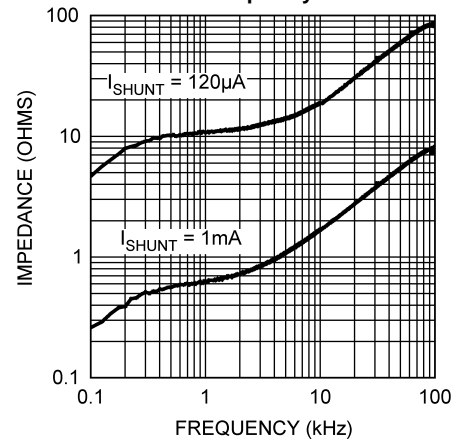


Figure 6.

Typical Performance Characteristics for 4.096V

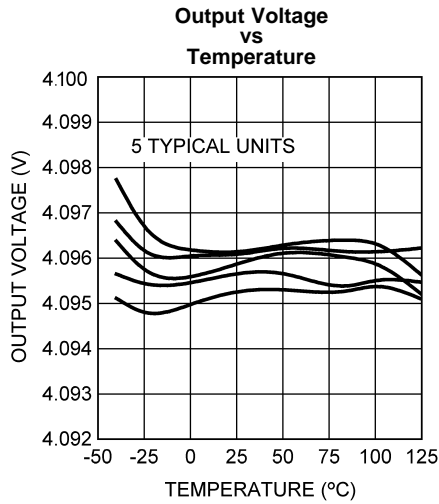


Figure 7.

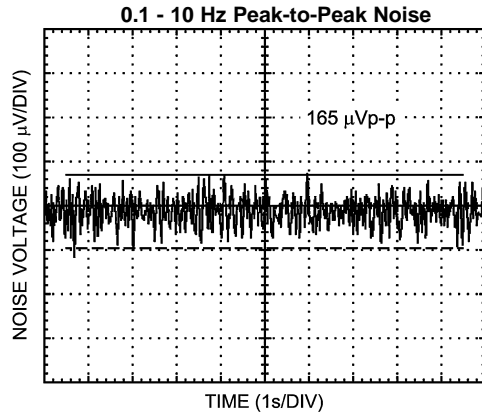


Figure 8.

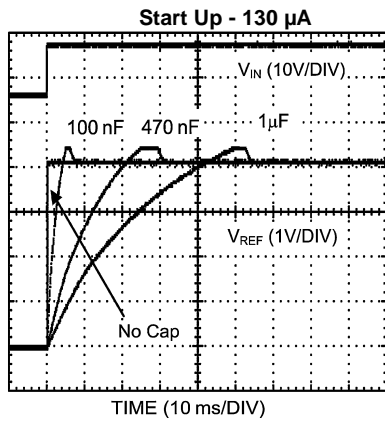


Figure 9.

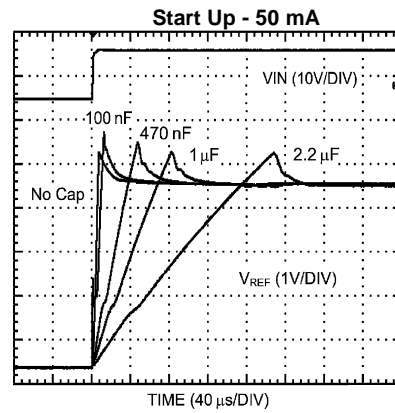


Figure 10.

Reverse Breakdown Voltage Change with Current

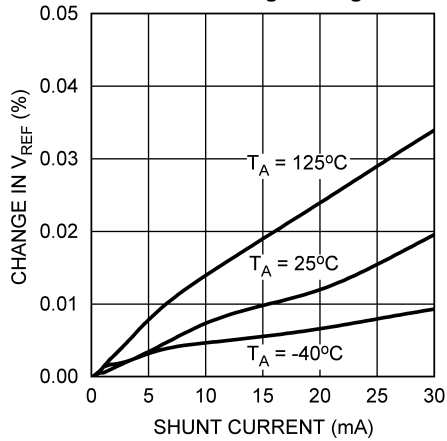


Figure 11.

Reverse Dynamic Impedance vs Frequency

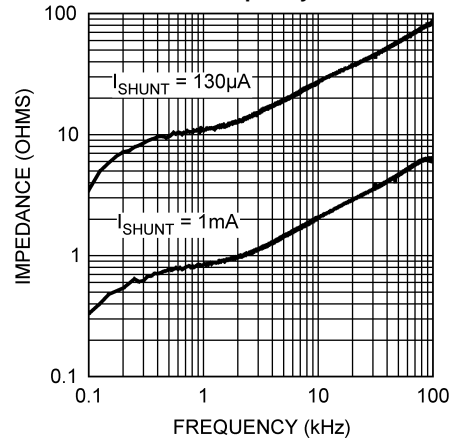


Figure 12.

Typical Performance Characteristics

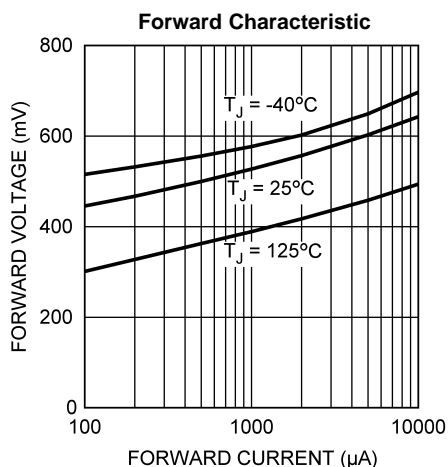


Figure 13.

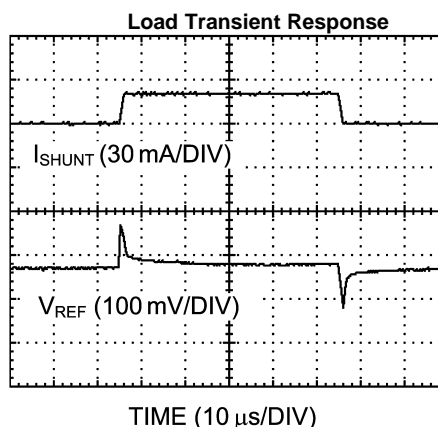


Figure 14.

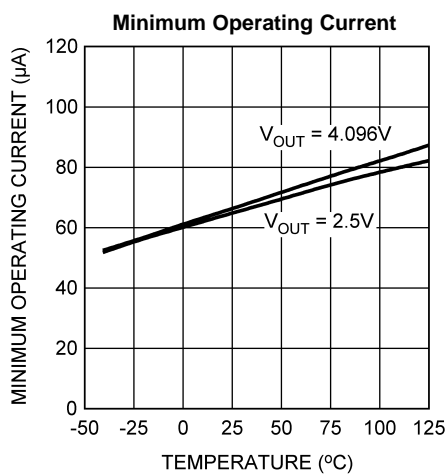


Figure 15.

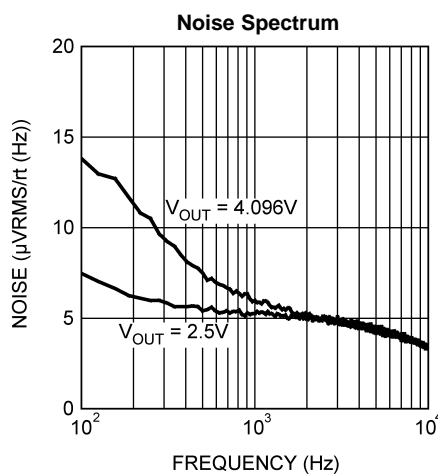


Figure 16.

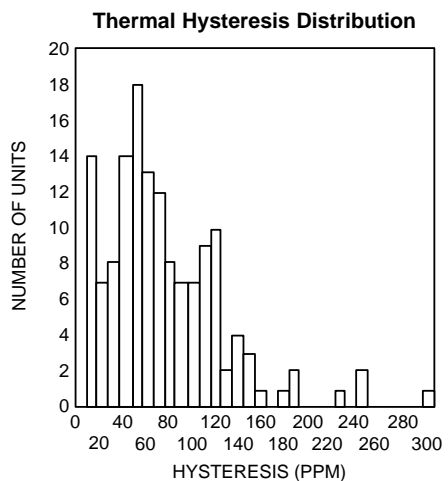


Figure 17.

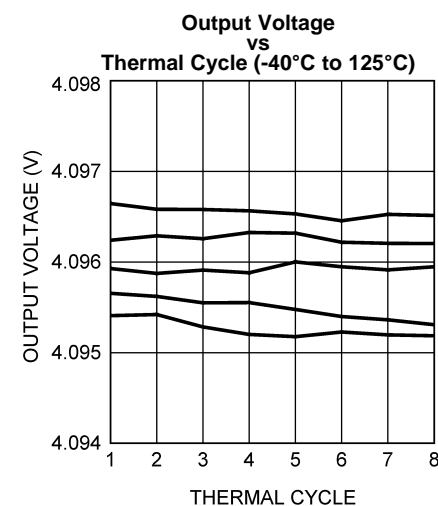


Figure 18.

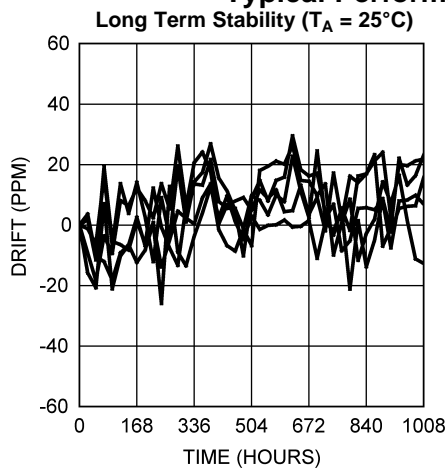
Typical Performance Characteristics (continued)

Figure 19.

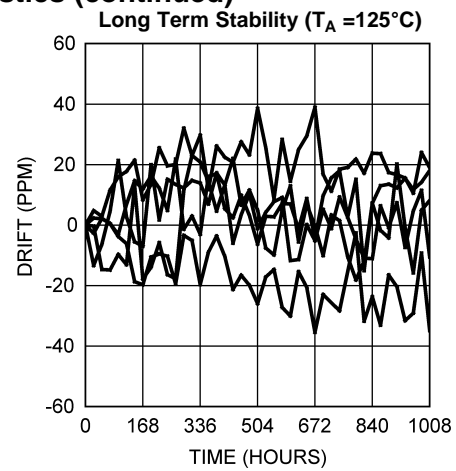


Figure 20.

APPLICATION INFORMATION

THEORY OF OPERATION

The LM4030 is an ultra-high precision shunt voltage reference, having exceptionally high initial accuracy (0.05%) and temperature stability (10ppm/°C). The LM4030 is available with fixed voltage options of 2.5V and 4.096V. Despite the tiny SOT-23 package, the LM4030 exhibits excellent thermal hysteresis (75ppm) and long-term stability (25ppm). The LM4030 is designed to operate without an external capacitor, but any capacitor up to 10 μF may be used. The LM4030 can be powered off as little as 120 μA (max) but is capable of shunting up to 30 mA continuously. The typical application circuit for the the LM4030 is shown in [Figure 21](#).

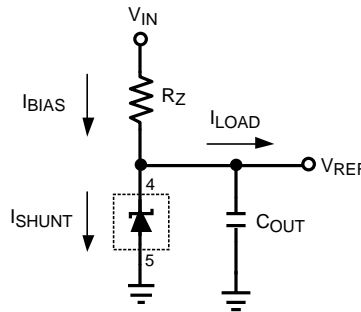


Figure 21. Typical Application Circuit

COMPONENT SELECTION

A resistor must be chosen to set the maximum operating current for the LM4030 (R_Z in [Figure 21](#)). The value of the resistor can be calculated using the following equation:

$$R_Z = (V_{IN} - V_{REF}) / (I_{MIN_OPERATING} + I_{LOAD_MAX}) \quad (1)$$

R_Z is chosen such that the total current flowing through R_Z is greater than the maximum load current plus the minimum operating current of the reference itself. This ensures that the reference is never starved for current. Running the LM4030 at higher currents is advantageous for reducing noise. The reverse dynamic impedance of the V_{REF} node scales inversely with the shunted current (see [Figure 22](#)) leading to higher rejection of noise emanating from the input supply and from EMI (electro-magnetic interference).

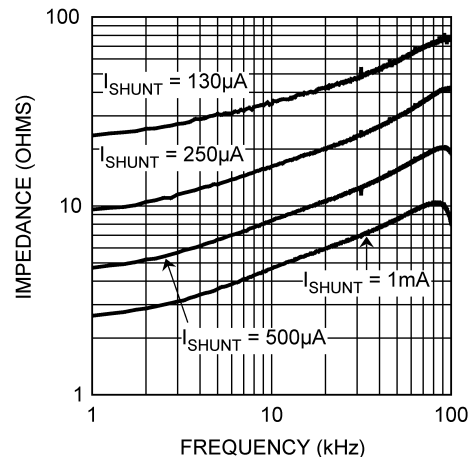


Figure 22. Reverse Dynamic Impedance vs I_{OUT}

The LM4030 is designed to operate with or without a bypass capacitor (C_{OUT} in [Figure 21](#)) and is stable with capacitors of up to 10 μF . The use of a bypass capacitor can improve transient response and reduce broadband noise. Additionally, a bypass capacitor will counter the rising reverse dynamic impedance at higher frequencies improving noise immunity (see [Figure 23](#)).

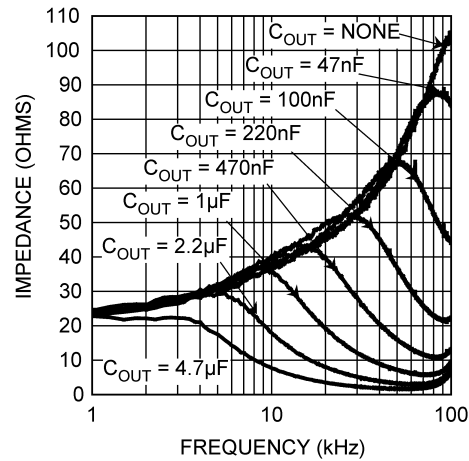


Figure 23. Reverse Dynamic Impedance vs C_{OUT}

As with other regulators, an external capacitor reduces the amplitude of the V_{REF} transient when a sudden change in loading takes place. The capacitor should be placed as close to the part as possible to reduce the effects of unwanted board parasitics.

THERMAL HYSTERESIS

Thermal hysteresis is defined as the change in output voltage at 25°C after some deviation from 25°C. This is to say that thermal hysteresis is the difference in output voltage between two points in a given temperature profile. An illustrative temperature profile is shown in [Figure 24](#).

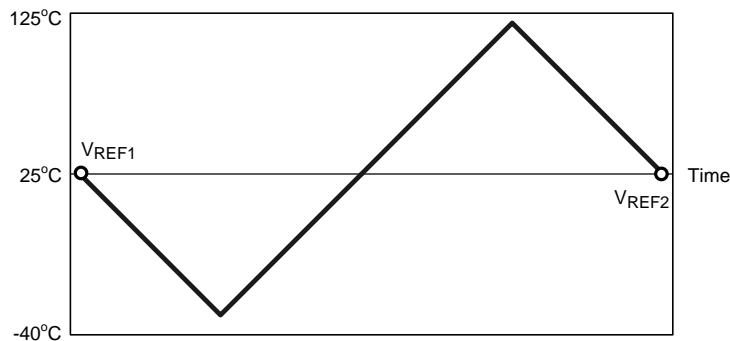


Figure 24. Illustrative Temperature Profile

This may be expressed analytically as the following:

$$V_{HYS} = \frac{|V_{REF1} - V_{REF2}|}{V_{REF}} \times 10^6 \text{ ppm}$$

where

- V_{HYS} = Thermal hysteresis expressed in ppm
- V_{REF} = Nominal preset output voltage
- $V_{REF1} = V_{REF}$ before temperature fluctuation
- $V_{REF2} = V_{REF}$ after temperature fluctuation

(2)

The LM4030 features a low thermal hysteresis of 75 ppm (typical) from -40°C to 125°C after 8 temperature cycles.

TEMPERATURE COEFFICIENT

Temperature drift is defined as the maximum deviation in output voltage over the temperature range. This deviation over temperature may be illustrated as shown in [Figure 25](#).

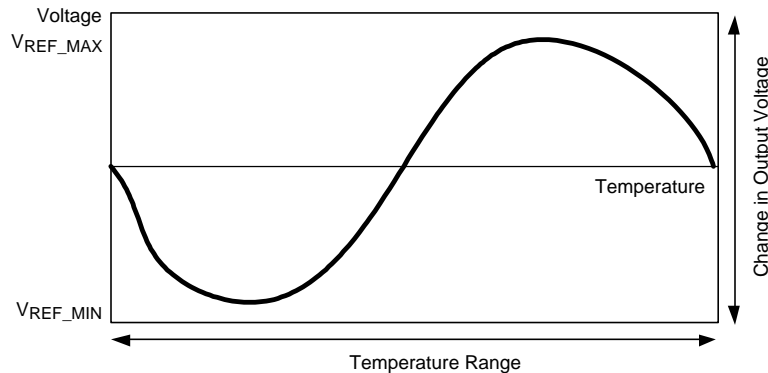


Figure 25. Illustrative V_{REF} vs Temperature Profile

Temperature coefficient may be expressed analytically as the following:

$$T_D = \frac{(V_{REF_MAX} - V_{REF_MIN})}{V_{REF} \times \Delta T} \times 10^6 \text{ ppm}$$

where

- T_D = Temperature drift
- V_{REF} = Nominal preset output voltage
- V_{REF_MIN} = Minimum output voltage over operating temperature range
- V_{REF_MAX} = Maximum output voltage over operating temperature range
- ΔT = Operating temperature range

(3)

The LM4030 features a low temperature drift of 10ppm (max) to 30ppm (max), depending on the grade.

DYNAMIC OFFSET CANCELLATION AND LONG TERM STABILITY

Aside from initial accuracy and drift performance, other specifications such as thermal hysteresis and long-term stability can affect the accuracy of a voltage reference, especially over the lifetime of the application. The reference voltage can also shift due to board stress once the part is mounted onto the PCB and during subsequent thermal cycles. Generally, these shifts in V_{REF} arise due to offsets between matched devices within the regulation loop. Both passive and active devices naturally experience drift over time and stress and temperature gradients across the silicon die also generate offset. The LM4030 incorporates a dynamic offset cancellation scheme which compensates for offsets developing within the regulation loop. This gives the LM4030 excellent long-term stability (40 ppm typical) and thermal hysteresis performance (75ppm typical), as well as substantial immunity to PCB stress effects, despite being packaged in a tiny SOT-23.

EXPRESSION OF ELECTRICAL CHARACTERISTICS

Electrical characteristics are typically expressed in mV, ppm, or a percentage of the nominal value. Depending on the application, one expression may be more useful than the other. To convert one quantity to the other one may apply the following:

ppm to mV error in output voltage:

$$\frac{V_{REF} \times \text{ppm}_{ERROR}}{10^3} = V_{ERROR}$$

where

- V_{REF} is in volts (V) and V_{ERROR} is in milli-volts (mV)

(4)

Bit error (1 bit) to voltage error (mV):

$$\frac{V_{REF}}{2^n} \times 10^3 = V_{ERROR} \quad (5)$$

V_{REF} is in volts (V), V_{ERROR} is in milli-volts (mV), and n is the number of bits.

mV to ppm error in output voltage:

$$\frac{V_{ERROR}}{V_{REF}} \times 10^3 = \text{ppm}_{ERROR}$$

where

- V_{REF} is in volts (V) and V_{ERROR} is in milli-volts (mV) (6)

Voltage error (mV) to percentage error (percent):

$$\frac{V_{ERROR}}{V_{REF}} \times 0.1 = \text{Percent_Error}$$

where

- V_{REF} is in volts (V) and V_{ERROR} is in milli-volts (mV) (7)

PRINTED CIRCUIT BOARD and LAYOUT CONSIDERATIONS

The LM4030 has a very small change in reverse voltage with current (25ppm/mA typical) so large variations in load current (up to 50mA) should not appreciably shift V_{REF} . Parasitic resistance between the LM4030 and the load introduces a voltage drop proportional to load current and should be minimized. The LM4030 should be placed as close to the load it is driving as the layout will allow. The location of R_Z is not important, but C_{OUT} should be as close to the LM4030 as possible so added ESR does not degrade the transient performance.

REVISION HISTORY

Changes from Revision A (April 2013) to Revision B	Page
• Changed layout of National Data Sheet to TI format	12

PACKAGING INFORMATION

Orderable Device	Status (1)	Package Type	Package Drawing	Pins	Package Qty	Eco Plan (2)	Lead/Ball Finish (6)	MSL Peak Temp (3)	Op Temp (°C)	Device Marking (4/5)	Samples
LM4030AMF-2.5/NOPB	ACTIVE	SOT-23	DBV	5	1000	Green (RoHS & no Sb/Br)	CU SN	Level-1-260C-UNLIM	-40 to 125	R5JA	Samples
LM4030AMF-4.096/NOPB	ACTIVE	SOT-23	DBV	5	1000	Green (RoHS & no Sb/Br)	CU SN	Level-1-260C-UNLIM	-40 to 125	R5KA	Samples
LM4030AMFX-2.5/NOPB	ACTIVE	SOT-23	DBV	5	3000	Green (RoHS & no Sb/Br)	CU SN	Level-1-260C-UNLIM	-40 to 125	R5JA	Samples
LM4030AMFX4.096/NOPB	ACTIVE	SOT-23	DBV	5	3000	Green (RoHS & no Sb/Br)	CU SN	Level-1-260C-UNLIM	-40 to 125	R5KA	Samples
LM4030BMF-2.5/NOPB	ACTIVE	SOT-23	DBV	5	1000	Green (RoHS & no Sb/Br)	CU SN	Level-1-260C-UNLIM	-40 to 125	R5JB	Samples
LM4030BMF-4.096/NOPB	ACTIVE	SOT-23	DBV	5	1000	Green (RoHS & no Sb/Br)	CU SN	Level-1-260C-UNLIM	-40 to 125	R5KB	Samples
LM4030BMFX-2.5/NOPB	ACTIVE	SOT-23	DBV	5	3000	Green (RoHS & no Sb/Br)	CU SN	Level-1-260C-UNLIM	-40 to 125	R5JB	Samples
LM4030BMFX4.096/NOPB	ACTIVE	SOT-23	DBV	5	3000	Green (RoHS & no Sb/Br)	CU SN	Level-1-260C-UNLIM	-40 to 125	R5KB	Samples
LM4030CMF-2.5/NOPB	ACTIVE	SOT-23	DBV	5	1000	Green (RoHS & no Sb/Br)	CU SN	Level-1-260C-UNLIM	-40 to 125	R5JC	Samples
LM4030CMF-4.096/NOPB	ACTIVE	SOT-23	DBV	5	1000	Green (RoHS & no Sb/Br)	CU SN	Level-1-260C-UNLIM	-40 to 125	R5KC	Samples
LM4030CMFX-2.5/NOPB	ACTIVE	SOT-23	DBV	5	3000	Green (RoHS & no Sb/Br)	CU SN	Level-1-260C-UNLIM	-40 to 125	R5JC	Samples
LM4030CMFX4.096/NOPB	ACTIVE	SOT-23	DBV	5	3000	Green (RoHS & no Sb/Br)	CU SN	Level-1-260C-UNLIM	-40 to 125	R5KC	Samples

(1) The marketing status values are defined as follows:

ACTIVE: Product device recommended for new designs.

LIFEBUY: TI has announced that the device will be discontinued, and a lifetime-buy period is in effect.

NRND: Not recommended for new designs. Device is in production to support existing customers, but TI does not recommend using this part in a new design.

PREVIEW: Device has been announced but is not in production. Samples may or may not be available.

OBSELETE: TI has discontinued the production of the device.

(2) Eco Plan - The planned eco-friendly classification: Pb-Free (RoHS), Pb-Free (RoHS Exempt), or Green (RoHS & no Sb/Br) - please check <http://www.ti.com/productcontent> for the latest availability information and additional product content details.

TBD: The Pb-Free/Green conversion plan has not been defined.

Pb-Free (RoHS): TI's terms "Lead-Free" or "Pb-Free" mean semiconductor products that are compatible with the current RoHS requirements for all 6 substances, including the requirement that lead not exceed 0.1% by weight in homogeneous materials. Where designed to be soldered at high temperatures, TI Pb-Free products are suitable for use in specified lead-free processes.

Pb-Free (RoHS Exempt): This component has a RoHS exemption for either 1) lead-based flip-chip solder bumps used between the die and package, or 2) lead-based die adhesive used between the die and leadframe. The component is otherwise considered Pb-Free (RoHS compatible) as defined above.

Green (RoHS & no Sb/Br): TI defines "Green" to mean Pb-Free (RoHS compatible), and free of Bromine (Br) and Antimony (Sb) based flame retardants (Br or Sb do not exceed 0.1% by weight in homogeneous material)

⁽³⁾ MSL, Peak Temp. - The Moisture Sensitivity Level rating according to the JEDEC industry standard classifications, and peak solder temperature.

⁽⁴⁾ There may be additional marking, which relates to the logo, the lot trace code information, or the environmental category on the device.

⁽⁵⁾ Multiple Device Markings will be inside parentheses. Only one Device Marking contained in parentheses and separated by a "~" will appear on a device. If a line is indented then it is a continuation of the previous line and the two combined represent the entire Device Marking for that device.

⁽⁶⁾ Lead/Ball Finish - Orderable Devices may have multiple material finish options. Finish options are separated by a vertical ruled line. Lead/Ball Finish values may wrap to two lines if the finish value exceeds the maximum column width.

Important Information and Disclaimer:The information provided on this page represents TI's knowledge and belief as of the date that it is provided. TI bases its knowledge and belief on information provided by third parties, and makes no representation or warranty as to the accuracy of such information. Efforts are underway to better integrate information from third parties. TI has taken and continues to take reasonable steps to provide representative and accurate information but may not have conducted destructive testing or chemical analysis on incoming materials and chemicals. TI and TI suppliers consider certain information to be proprietary, and thus CAS numbers and other limited information may not be available for release.

In no event shall TI's liability arising out of such information exceed the total purchase price of the TI part(s) at issue in this document sold by TI to Customer on an annual basis.

TAPE AND REEL INFORMATION

QUADRANT ASSIGNMENTS FOR PIN 1 ORIENTATION IN TAPE


*All dimensions are nominal

Device	Package Type	Package Drawing	Pins	SPQ	Reel Diameter (mm)	Reel Width W1 (mm)	A0 (mm)	B0 (mm)	K0 (mm)	P1 (mm)	W (mm)	Pin1 Quadrant
LM4030AMF-2.5/NOPB	SOT-23	DBV	5	1000	178.0	8.4	3.2	3.2	1.4	4.0	8.0	Q3
LM4030AMF-4.096/NOPB	SOT-23	DBV	5	1000	178.0	8.4	3.2	3.2	1.4	4.0	8.0	Q3
LM4030AMFX-2.5/NOPB	SOT-23	DBV	5	3000	178.0	8.4	3.2	3.2	1.4	4.0	8.0	Q3
LM4030AMFX4.096/NOPB	SOT-23	DBV	5	3000	178.0	8.4	3.2	3.2	1.4	4.0	8.0	Q3
LM4030BMF-2.5/NOPB	SOT-23	DBV	5	1000	178.0	8.4	3.2	3.2	1.4	4.0	8.0	Q3
LM4030BMF-4.096/NOPB	SOT-23	DBV	5	1000	178.0	8.4	3.2	3.2	1.4	4.0	8.0	Q3
LM4030BMFX-2.5/NOPB	SOT-23	DBV	5	3000	178.0	8.4	3.2	3.2	1.4	4.0	8.0	Q3
LM4030BMFX4.096/NOPB	SOT-23	DBV	5	3000	178.0	8.4	3.2	3.2	1.4	4.0	8.0	Q3
LM4030CMF-2.5/NOPB	SOT-23	DBV	5	1000	178.0	8.4	3.2	3.2	1.4	4.0	8.0	Q3
LM4030CMF-4.096/NOPB	SOT-23	DBV	5	1000	178.0	8.4	3.2	3.2	1.4	4.0	8.0	Q3
LM4030CMFX-2.5/NOPB	SOT-23	DBV	5	3000	178.0	8.4	3.2	3.2	1.4	4.0	8.0	Q3
LM4030CMFX4.096/NOPB	SOT-23	DBV	5	3000	178.0	8.4	3.2	3.2	1.4	4.0	8.0	Q3

TAPE AND REEL BOX DIMENSIONS


*All dimensions are nominal

Device	Package Type	Package Drawing	Pins	SPQ	Length (mm)	Width (mm)	Height (mm)
LM4030AMF-2.5/NOPB	SOT-23	DBV	5	1000	210.0	185.0	35.0
LM4030AMF-4.096/NOPB	SOT-23	DBV	5	1000	210.0	185.0	35.0
LM4030AMFX-2.5/NOPB	SOT-23	DBV	5	3000	210.0	185.0	35.0
LM4030AMFX4.096/NOPB	SOT-23	DBV	5	3000	210.0	185.0	35.0
LM4030BMF-2.5/NOPB	SOT-23	DBV	5	1000	210.0	185.0	35.0
LM4030BMF-4.096/NOPB	SOT-23	DBV	5	1000	210.0	185.0	35.0
LM4030BMFX-2.5/NOPB	SOT-23	DBV	5	3000	210.0	185.0	35.0
LM4030BMFX4.096/NOPB	SOT-23	DBV	5	3000	210.0	185.0	35.0
LM4030CMF-2.5/NOPB	SOT-23	DBV	5	1000	210.0	185.0	35.0
LM4030CMF-4.096/NOPB	SOT-23	DBV	5	1000	210.0	185.0	35.0
LM4030CMFX-2.5/NOPB	SOT-23	DBV	5	3000	210.0	185.0	35.0
LM4030CMFX4.096/NOPB	SOT-23	DBV	5	3000	210.0	185.0	35.0

DBV (R-PDSO-G5)

PLASTIC SMALL OUTLINE



- NOTES:
- A. All linear dimensions are in millimeters.
 - B. This drawing is subject to change without notice.
 - C. Customers should place a note on the circuit board fabrication drawing not to alter the center solder mask defined pad.
 - D. Publication IPC-7351 is recommended for alternate designs.
 - E. Laser cutting apertures with trapezoidal walls and also rounding corners will offer better paste release. Customers should contact their board assembly site for stencil design recommendations. Example stencil design based on a 50% volumetric metal load solder paste. Refer to IPC-7525 for other stencil recommendations.

IMPORTANT NOTICE

Texas Instruments Incorporated and its subsidiaries (TI) reserve the right to make corrections, enhancements, improvements and other changes to its semiconductor products and services per JESD46, latest issue, and to discontinue any product or service per JESD48, latest issue. Buyers should obtain the latest relevant information before placing orders and should verify that such information is current and complete. All semiconductor products (also referred to herein as "components") are sold subject to TI's terms and conditions of sale supplied at the time of order acknowledgment.

TI warrants performance of its components to the specifications applicable at the time of sale, in accordance with the warranty in TI's terms and conditions of sale of semiconductor products. Testing and other quality control techniques are used to the extent TI deems necessary to support this warranty. Except where mandated by applicable law, testing of all parameters of each component is not necessarily performed.

TI assumes no liability for applications assistance or the design of Buyers' products. Buyers are responsible for their products and applications using TI components. To minimize the risks associated with Buyers' products and applications, Buyers should provide adequate design and operating safeguards.

TI does not warrant or represent that any license, either express or implied, is granted under any patent right, copyright, mask work right, or other intellectual property right relating to any combination, machine, or process in which TI components or services are used. Information published by TI regarding third-party products or services does not constitute a license to use such products or services or a warranty or endorsement thereof. Use of such information may require a license from a third party under the patents or other intellectual property of the third party, or a license from TI under the patents or other intellectual property of TI.

Reproduction of significant portions of TI information in TI data books or data sheets is permissible only if reproduction is without alteration and is accompanied by all associated warranties, conditions, limitations, and notices. TI is not responsible or liable for such altered documentation. Information of third parties may be subject to additional restrictions.

Resale of TI components or services with statements different from or beyond the parameters stated by TI for that component or service voids all express and any implied warranties for the associated TI component or service and is an unfair and deceptive business practice. TI is not responsible or liable for any such statements.

Buyer acknowledges and agrees that it is solely responsible for compliance with all legal, regulatory and safety-related requirements concerning its products, and any use of TI components in its applications, notwithstanding any applications-related information or support that may be provided by TI. Buyer represents and agrees that it has all the necessary expertise to create and implement safeguards which anticipate dangerous consequences of failures, monitor failures and their consequences, lessen the likelihood of failures that might cause harm and take appropriate remedial actions. Buyer will fully indemnify TI and its representatives against any damages arising out of the use of any TI components in safety-critical applications.

In some cases, TI components may be promoted specifically to facilitate safety-related applications. With such components, TI's goal is to help enable customers to design and create their own end-product solutions that meet applicable functional safety standards and requirements. Nonetheless, such components are subject to these terms.

No TI components are authorized for use in FDA Class III (or similar life-critical medical equipment) unless authorized officers of the parties have executed a special agreement specifically governing such use.

Only those TI components which TI has specifically designated as military grade or "enhanced plastic" are designed and intended for use in military/aerospace applications or environments. Buyer acknowledges and agrees that any military or aerospace use of TI components which have **not** been so designated is solely at the Buyer's risk, and that Buyer is solely responsible for compliance with all legal and regulatory requirements in connection with such use.

TI has specifically designated certain components as meeting ISO/TS16949 requirements, mainly for automotive use. In any case of use of non-designated products, TI will not be responsible for any failure to meet ISO/TS16949.

Products

Audio	www.ti.com/audio
Amplifiers	amplifier.ti.com
Data Converters	dataconverter.ti.com
DLP® Products	www.dlp.com
DSP	dsp.ti.com
Clocks and Timers	www.ti.com/clocks
Interface	interface.ti.com
Logic	logic.ti.com
Power Mgmt	power.ti.com
Microcontrollers	microcontroller.ti.com
RFID	www.ti-rfid.com
OMAP Applications Processors	www.ti.com/omap
Wireless Connectivity	www.ti.com/wirelessconnectivity

Applications

Automotive and Transportation	www.ti.com/automotive
Communications and Telecom	www.ti.com/communications
Computers and Peripherals	www.ti.com/computers
Consumer Electronics	www.ti.com/consumer-apps
Energy and Lighting	www.ti.com/energy
Industrial	www.ti.com/industrial
Medical	www.ti.com/medical
Security	www.ti.com/security
Space, Avionics and Defense	www.ti.com/space-avionics-defense
Video and Imaging	www.ti.com/video

TI E2E Community

e2e.ti.com