

LM9076 150mA Ultra-Low Quiescent Current LDO Regulator with Delayed Reset Output

 Check for Samples: [LM9076](#)

FEATURES

- Available with 5.0V or 3.3V Output Voltage
- Ultra Low Ground Pin Current, 25 μA Typical for 100 μA Load
- V_{OUT} Initial Accuracy of $\pm 1.5\%$
- V_{OUT} Accurate to $\pm 3\%$ Over Load and Temperature Conditions
- Low Dropout Voltage, 200 mV Typical with 150 mA Load
- Low Off State Ground Pin current for LM9076BMA
- Delayed $\overline{\text{RESET}}$ Output Pin for Low V_{OUT} Detection
- +70V/-50V Voltage Transients
- Operational V_{IN} up to +40V

DESCRIPTION

The LM9076 is a $\pm 3\%$, 150 mA logic controlled voltage regulator. The regulator features an active low delayed reset output flag which can be used to reset a microprocessor system at turn-ON and in the event that the regulator output voltage falls below a minimum value. An external capacitor programs a delay time interval before the reset output pin can return high.

Designed for automotive and industrial applications, the LM9076 contains a variety of protection features such as thermal shutdown, input transient protection and a wide operating temperature range. The LM9076 uses an PNP pass transistor which allows low drop-out voltage operation.

Typical Applications

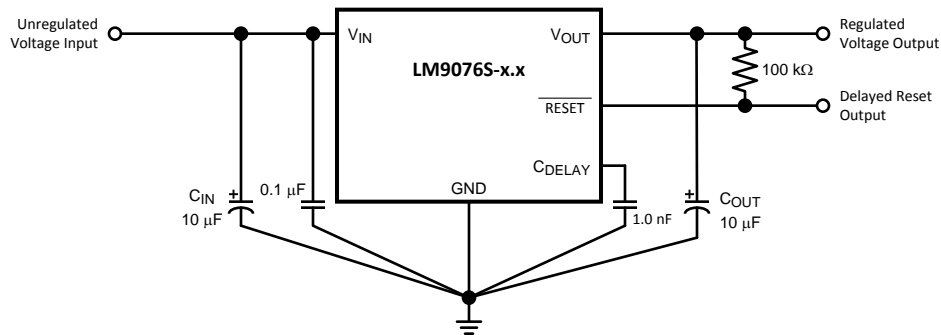

Figure 1. LM9076S-x.x in 5 lead SFM package

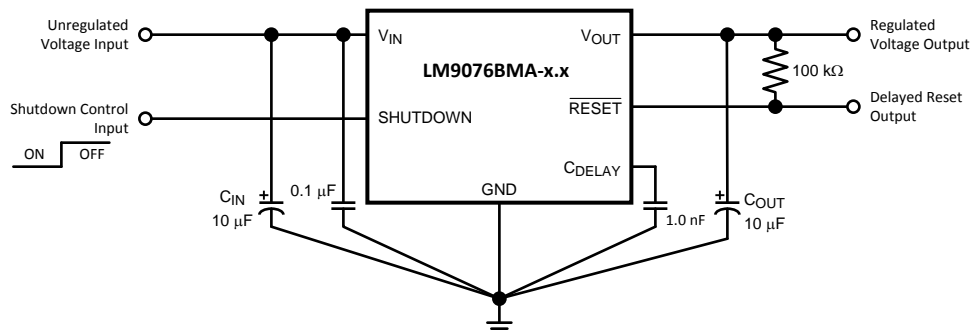

Figure 2. LM9076BMA-x.x in 8 lead SOIC package



Please be aware that an important notice concerning availability, standard warranty, and use in critical applications of Texas Instruments semiconductor products and disclaimers thereto appears at the end of this data sheet.

All trademarks are the property of their respective owners.

Connection Diagram

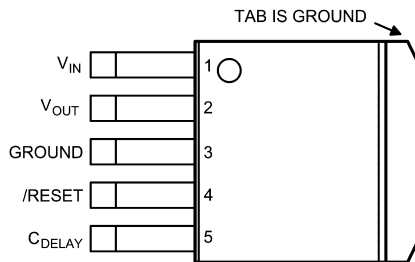

Figure 3. Top View
Part Numbers LM9076S-3.3 and LM9076S-5.0
See SFM Package Number KTT0005B

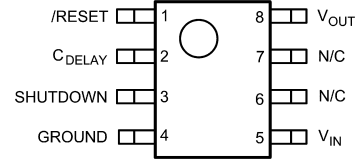

Figure 4. Top View
Part Numbers LM9076BMA-3.3 and
LM9076BMA-5.0
See SOIC Package Number D



These devices have limited built-in ESD protection. The leads should be shorted together or the device placed in conductive foam during storage or handling to prevent electrostatic damage to the MOS gates.

Absolute Maximum Ratings⁽¹⁾

$V_{IN}(DC)$	-15V to +55V
$V_{IN}(+Transient) t < 10ms, Duty Cycle < 1\%$	+70V
$V_{IN}(-Transient) t < 1ms, Duty Cycle < 1\%$	-50V
SHUTDOWN Pin	-15V to +52V
\overline{RESET} Pin	-0.3V to 20V
C_{DELAY} Pin	-0.3V to $V_{OUT} + 0.3V$
Storage Temperature	-65°C to +150°C
Junction Temperature (T_J)	+175°C
ESD, HBM, per AEC - Q100 - 002	+/- 2 kV
ESD, MM, per AEC - Q100 - 003	+/- 250V

(1) Absolute Maximum Ratings indicate the limits beyond which the device may cease to function, and/or damage to the device may occur.

Operating Ratings⁽¹⁾⁽²⁾

V_{IN} Pin		5.35V to 40V
$V_{SHUTDOWN}$ Pin		0V to 40V
Junction Temperature		-40°C < T_J < +125°C
Thermal Resistance KTT0005B ⁽³⁾	θ_{JA}	75°C/W
	θ_{JC}	2.9°C/W
Thermal Resistance D ⁽³⁾	θ_{JA}	156°C/W
	θ_{JC}	59°C/W

(1) Absolute Maximum Ratings indicate the limits beyond which the device may cease to function, and/or damage to the device may occur.

(2) Operating Ratings indicate conditions for which the device is intended to be functional, but does not ensure specific performance limits. For ensured specifications and conditions refer to the Electrical Characteristics

(3) Worst case (FREE AIR) per EIA/JESD51-3.

Electrical Characteristics for LM9076–3.3

The following specifications apply for $V_{IN} = 14V$; $I_{LOAD} = 10\text{ mA}$; $T_J = +25^\circ\text{C}$; $C_{OUT} = 10\text{ }\mu\text{F}$, $0.5\Omega < \text{ESR} < 4.0\Omega$; unless otherwise specified. **Bold values indicate $-40^\circ\text{C} \leq T_J \leq +125^\circ\text{C}$.** ⁽¹⁾⁽²⁾⁽³⁾ Minimum and Maximum limits are specified through test, design or statistical correlation.

Symbol	Parameter	Conditions	Min	Typ	Max	Units
LM9076–3.3 REGULATOR CHARACTERISTICS						
V_{OUT}	Output Voltage		3.251	3.30	3.349	V
		$-20^\circ\text{C} \leq T_J \leq 85^\circ\text{C}$ $1\text{ mA} \leq I_{LOAD} \leq 150\text{ mA}$	3.234	3.30	3.366	V
		$1\text{ mA} \leq I_{LOAD} \leq 150\text{ mA}$	3.201	3.30	3.399	V
		$V_{IN} = 60V$, $R_{LOAD} = 1\text{ k}\Omega$, $t \leq 40\text{ ms}$	2.970	3.30	3.630	V
	Output Voltage Off LM9076 BMA only	$V_{SHUTDOWN} \geq 2V$, $R_{LOAD} = 1\text{ k}\Omega$	–	0	250	mV
	Reverse Battery	$V_{IN} = -15V$, $R_{LOAD} = 1\text{ k}\Omega$	-300	0	–	mV
ΔV_{OUT}	Line Regulation	$9.0V \leq V_{IN} \leq 16V$, $I_{LOAD} = 10\text{ mA}$	–	4	25	mV
		$16V \leq V_{IN} \leq 40V$, $I_{LOAD} = 10\text{ mA}$	–	17	35	mV
	Load Regulation	$1\text{ mA} \leq I_{LOAD} \leq 150\text{ mA}$	–	42	60	mV
V_{DO}	Dropout Voltage	$I_{LOAD} = 10\text{ mA}$	–	30	50	mV
		$I_{LOAD} = 50\text{ mA}$	–	80	–	mV
		$I_{LOAD} = 150\text{ mA}$	–	150	250	mV
I_{GND}	Ground Pin Current	$9V \leq V_{IN} \leq 16V$, $I_{LOAD} = 100\text{ }\mu\text{A}$	–	25	45	μA
		$9V \leq V_{IN} \leq 40V$, $I_{LOAD} = 10\text{ mA}$	–	125	160	μA
		$9V \leq V_{IN} \leq 40V$, $I_{LOAD} = 50\text{ mA}$	–	0.6	–	mA
		$9V \leq V_{IN} \leq 16V$, $I_{LOAD} = 150\text{ mA}$	–	3.6	4.5	mA
I_{SC}	V_{OUT} Short Circuit Current	$V_{IN} = 14V$, $R_{LOAD} = 1\Omega$	200	400	750	mA
PSRR	Ripple Rejection	$V_{IN} = (14V_{DC}) + (1V_{RMS} @ 120\text{ Hz})$ $I_{LOAD} = 50\text{ mA}$	50	60	–	dB
RESET PIN CHARACTERISTICS						
V_{OR}	Minimum V_{IN} for valid RESET Status	(Note 3)	–	1.3	2.0	V
V_{THR}	V_{OUT} Threshold for RESET Low	(Note 3)	0.83	0.89	0.94	$X V_{OUT}$ (Nom)
V_{OH}	$\overline{\text{RESET}}$ pin high voltage	External pull-up resistor to $V_{OUT} = 100\text{ k}\Omega$	$V_{OUT} \times 0.90$	$V_{OUT} \times 0.99$	V_{OUT}	V
V_{OL}	$\overline{\text{RESET}}$ pin low voltage	$C_{DELAY} < 4.0V$, $I_{SINK} = 250\text{ }\mu\text{A}$	–	0.2	0.3	V

- (1) The regulated output voltage specification is not ensured for the entire range of V_{IN} and output loads. Device operational range is limited by the maximum junction temperature (T_J). The junction temperature is influenced by the ambient temperature (T_A), package selection, input voltage (V_{IN}), and the output load current. When operating with maximum load currents the input voltage and/or ambient temperature will be limited. When operating with maximum input voltage the load current and/or the ambient temperature will be limited.
- (2) Pulse testing used maintain constant junction temperature (T_J).
- (3) Not Production tested, Specified by Design. Minimum, Typical, and/or Maximum values are provided for informational purposes only.

Electrical Characteristics for LM9076–3.3 (continued)

The following specifications apply for $V_{IN} = 14V$; $I_{LOAD} = 10\text{ mA}$; $T_J = +25^\circ\text{C}$; $C_{OUT} = 10\text{ }\mu\text{F}$, $0.5\Omega < \text{ESR} < 4.0\Omega$; unless otherwise specified. **Bold values indicate $-40^\circ\text{C} \leq T_J \leq +125^\circ\text{C}$.** ⁽¹⁾⁽²⁾⁽³⁾ Minimum and Maximum limits are specified through test, design or statistical correlation.

Symbol	Parameter	Conditions	Min	Typ	Max	Units
C_{DELAY} PIN CHARACTERISTICS						
I_{DELAY}	C _{DELAY} Charging Current	$V_{IN} = 14V$, $V_{DELAY} = 0V$	-0.70	-0.42	-0.25	μA
V_{OL}	C _{DELAY} pin low voltage	$V_{OUT} < 4.0V$, $I_{SINK} = I_{DELAY}$	–	0.100	–	V
t_{DELAY}	Reset Delay Time	$V_{IN} = 14V$, $C_{DELAY} = 0.001\text{ }\mu\text{F}$ V_{OUT} rising from 0V, Δt from $V_{OUT} > V_{OR}$ to RESET pin HIGH	4.7	7.8	13.2	ms

Electrical Characteristics for LM9076–5.0

The following specifications apply for $V_{IN} = 14V$; $V_{SHUTDOWN} = \text{Open}$; $I_{LOAD} = 10\text{ mA}$; $T_J = +25^\circ\text{C}$; $C_{OUT} = 10\text{ }\mu\text{F}$, $0.5\Omega < \text{ESR} < 4.0\Omega$; unless otherwise specified. **Bold Values indicate $-40^\circ\text{C} \leq T_J \leq 125^\circ\text{C}$.** ⁽¹⁾⁽²⁾⁽³⁾ Minimum and Maximum limits are specified through test, design, or statistical correlation.

Symbol	Parameter	Conditions	Min	Typ	Max	Units
LM9076–5.0 REGULATOR CHARACTERISTICS						
V_{OUT}	Output Voltage	$-20^\circ\text{C} \leq T_J \leq 85^\circ\text{C}$ $1\text{ mA} \leq I_{LOAD} \leq 150\text{ mA}$	4.925	5.00	5.075	V
		$1\text{ mA} \leq I_{LOAD} \leq 150\text{ mA}$	4.900	5.00	5.100	V
		4.850	5.00	5.150	V	
		$V_{IN} = 60V$, $R_{LOAD} = 1\text{ k}\Omega$, $t \leq 40\text{ms}$	4.500	5.00	5.500	V
	Output Voltage Off LM9076 BMA only	$V_{SHUTDOWN} \geq 2V$, $R_{LOAD} = 1\text{ k}\Omega$	–	0	250	mV
Reverse Battery	$V_{IN} = -15V$, $R_{LOAD} = 1\text{ k}\Omega$	-300	0	–	mV	
ΔV_{OUT}	Line Regulation	$9.0V \leq V_{IN} \leq 16V$, $I_{LOAD} = 10\text{ mA}$	–	4	25	mV
		$16V \leq V_{IN} \leq 40V$, $I_{LOAD} = 10\text{ mA}$	–	17	35	mV
	Load Regulation	$1\text{ mA} \leq I_{LOAD} \leq 150\text{ mA}$	–	42	60	mV
V_{DO}	Dropout Voltage	$I_{LOAD} = 10\text{ mA}$	–	30	50	mV
		$I_{LOAD} = 50\text{ mA}$	–	80	–	mV
		$I_{LOAD} = 150\text{ mA}$	–	150	250	mV
I_{GND}	Ground Pin Current	$9V \leq V_{IN} \leq 16V$, $I_{LOAD} = 100\text{ }\mu\text{A}$	–	25	45	μA
		$9V \leq V_{IN} \leq 40V$, $I_{LOAD} = 10\text{ mA}$	–	125	160	μA
		$9V \leq V_{IN} \leq 40V$, $I_{LOAD} = 50\text{ mA}$	–	0.6	–	mA
		$9V \leq V_{IN} \leq 16V$, $I_{LOAD} = 150\text{ mA}$	–	3.6	4.5	mA
	Ground Pin Current in Shutdown Mode	$9V \leq V_{IN} \leq 40V$, $V_{SHUTDOWN} = 2V$	–	15	25	μA

(1) Pulse testing used maintain constant junction temperature (T_J).

(2) The regulated output voltage specification is not ensured for the entire range of V_{IN} and output loads. Device operational range is limited by the maximum junction temperature (T_J). The junction temperature is influenced by the ambient temperature (T_A), package selection, input voltage (V_{IN}), and the output load current. When operating with maximum load currents the input voltage and/or ambient temperature will be limited. When operating with maximum input voltage the load current and/or the ambient temperature will be limited.

(3) Not Production tested, Specified by Design. Minimum, Typical, and/or Maximum values are provided for informational purposes only.

Electrical Characteristics for LM9076–5.0 (continued)

The following specifications apply for $V_{IN} = 14V$; $V_{SHUTDOWN} = \text{Open}$; $I_{LOAD} = 10 \text{ mA}$; $T_J = +25^\circ\text{C}$; $C_{OUT} = 10 \mu\text{F}$, $0.5\Omega < \text{ESR} < 4.0\Omega$; unless otherwise specified. **Bold Values indicate $-40^\circ\text{C} \leq T_J \leq 125^\circ\text{C}$.**⁽¹⁾⁽²⁾⁽³⁾ Minimum and Maximum limits are specified through test, design, or statistical correlation.

Symbol	Parameter	Conditions	Min	Typ	Max	Units
I_{SC}	V_{OUT} Short Circuit Current	$V_{IN} = 14V$, $R_{LOAD} = 1\Omega$	200	400	750	mA
PSRR	Ripple Rejection	$V_{IN} = (14V_{DC}) + (1V_{RMS} @ 120\text{Hz})$ $I_{LOAD} = 50 \text{ mA}$	50	60	–	dB
RESET PIN CHARACTERISTICS						
V_{OR}	Minimum V_{IN} for valid RESET Status	(Note 3)	–	1.3	2.0	V
V_{THR}	V_{OUT} Threshold for RESET Low	(Note 3)	0.83	0.89	0.94	X V_{OUT} (Nom)
V_{OH}	$\overline{\text{RESET}}$ pin high voltage	External pull-up resistor to $V_{OUT} = 100 \text{ k}\Omega$	$V_{OUT} \times 0.90$	$V_{OUT} \times 0.99$	V_{OUT}	V
V_{OL}	$\overline{\text{RESET}}$ pin low voltage	$C_{DELAY} < 4.0V$, $I_{SINK} = 250 \mu\text{A}$	–	0.2	0.3	V
C_{DELAY} PIN CHARACTERISTICS						
I_{DELAY}	C_{DELAY} Charging Current	$V_{IN} = 14V$, $V_{DELAY} = 0V$	-0.70	-0.42	-0.25	μA
V_{OL}	C_{DELAY} pin low voltage	$V_{OUT} < 4.0V$, $I_{SINK} = I_{DELAY}$	–	0.100	–	V
t_{DELAY}	Reset Delay Time	$V_{IN} = 14V$, $C_{DELAY} = 0.001 \mu\text{F}$ V_{OUT} rising from 0V, Δt from $V_{OUT} > V_{OR}$ to RESET pin HIGH	7.1	11.9	20.0	ms
SHUTDOWN CONTROL LOGIC — LM9076BMA-5.0 Only						
$V_{IL(SD)}$	SHUTDOWN Pin Low Threshold Voltage	$V_{SHUTDOWN}$ pin falling from 5.0V until $V_{OUT} > 4.5V$ ($V_{OUT} = \text{On}$)	1	1.5	–	V
$V_{IH(SD)}$	SHUTDOWN Pin High Threshold Voltage	$V_{SHUTDOWN}$ pin rising from 0V until $V_{OUT} < 0.5V$ ($V_{OUT} = \text{Off}$)	–	1.5	2	V
$I_{IH(SD)}$	SHUTDOWN Pin High Bias Current	$V_{SHUTDOWN} = 40V$	–	35	–	μA
		$V_{SHUTDOWN} = 5V$	–	15	35	μA
		$V_{SHUTDOWN} = 2V$	–	6	10	μA
$I_{IL(SD)}$	SHUTDOWN Pin Low Bias Current	$V_{SHUTDOWN} = 0V$	–	0	–	μA

Typical Performance Characteristics

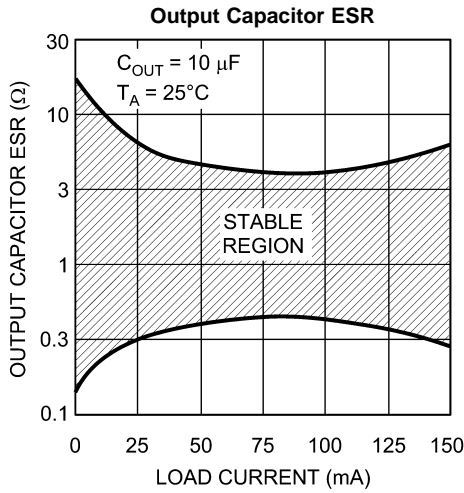

Figure 5.

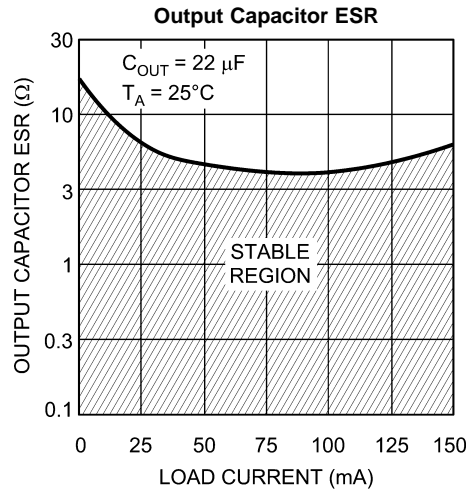

Figure 6.

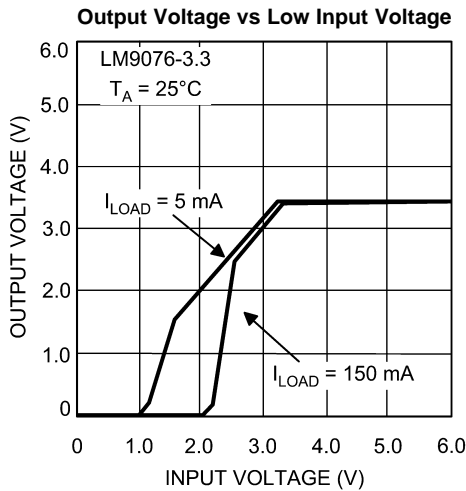

Figure 7.

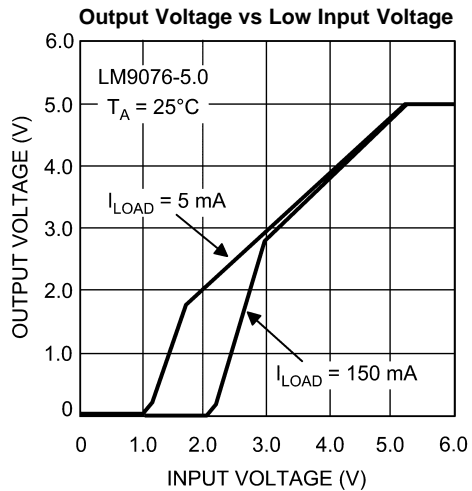

Figure 8.

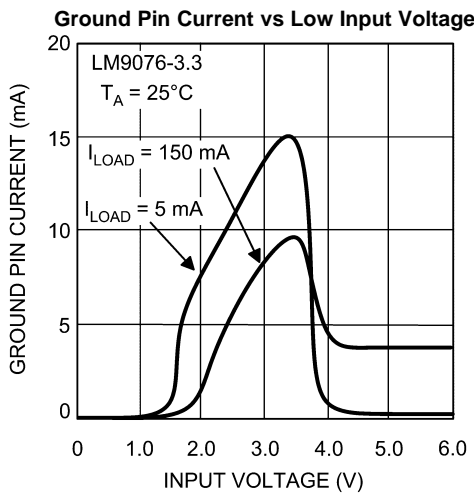

Figure 9.

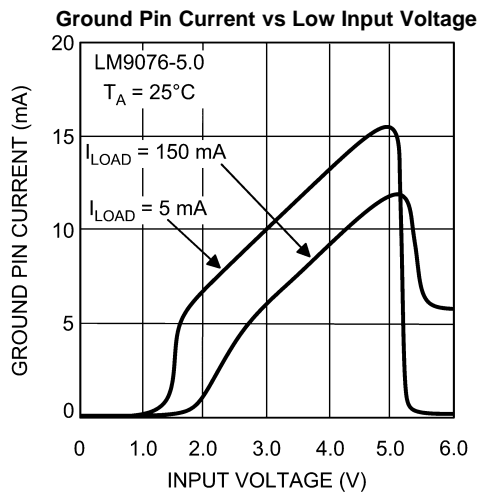

Figure 10.

Typical Performance Characteristics (continued)

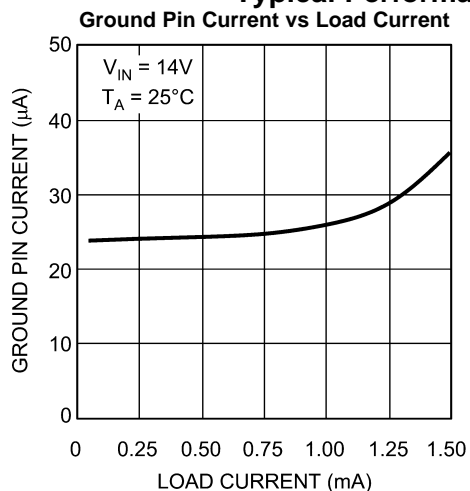

Figure 11.

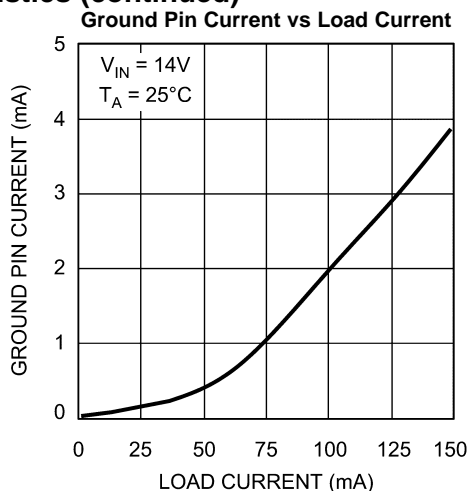

Figure 12.

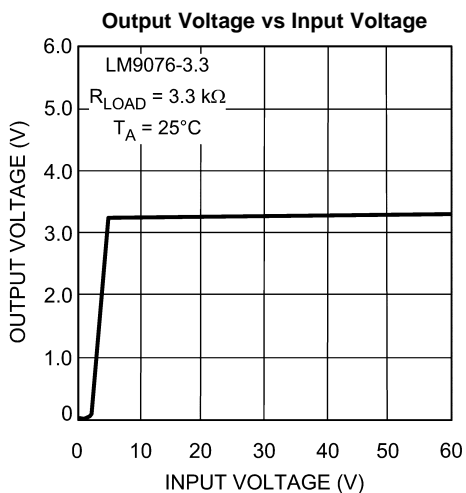

Figure 13.

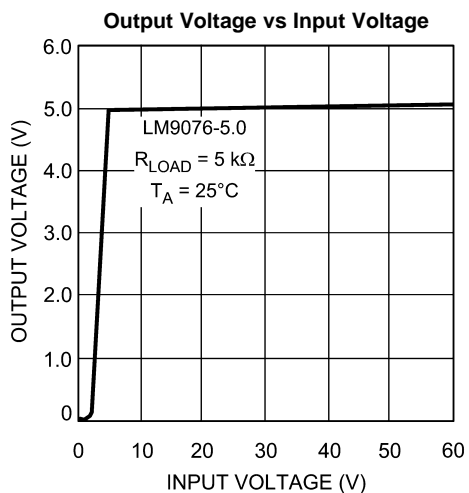

Figure 14.

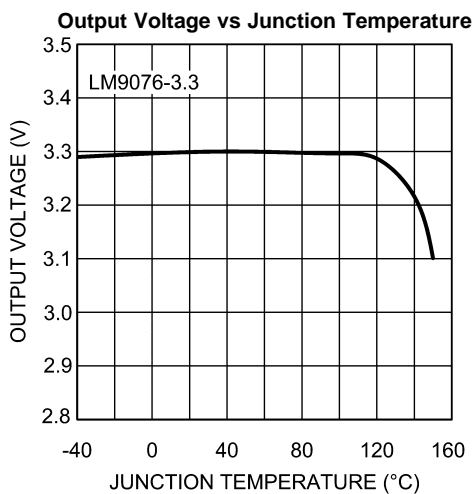

Figure 15.

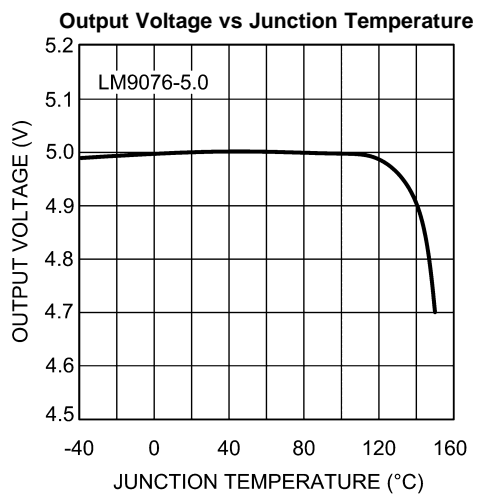

Figure 16.

Typical Performance Characteristics (continued)

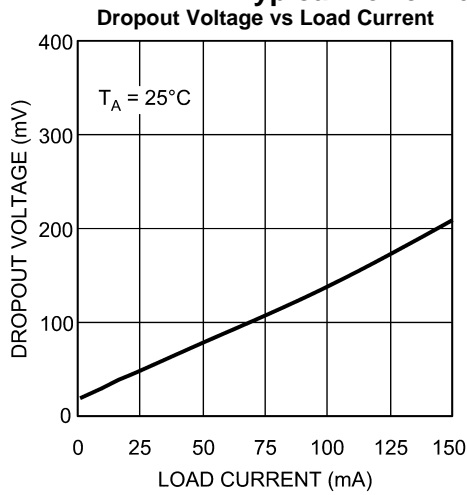

Figure 17.

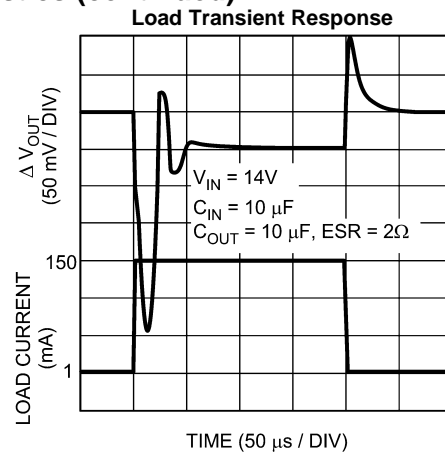

Figure 18.

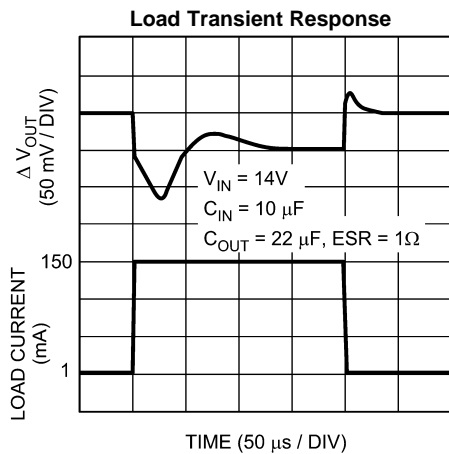

Figure 19.

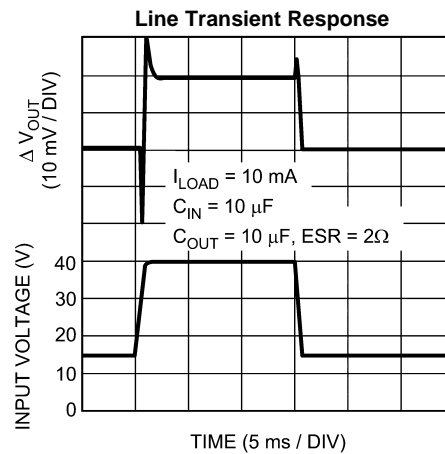

Figure 20.

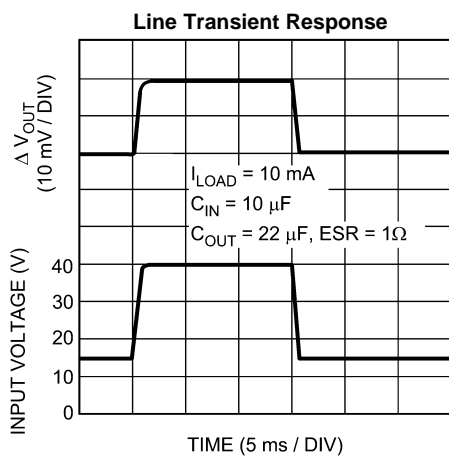

Figure 21.

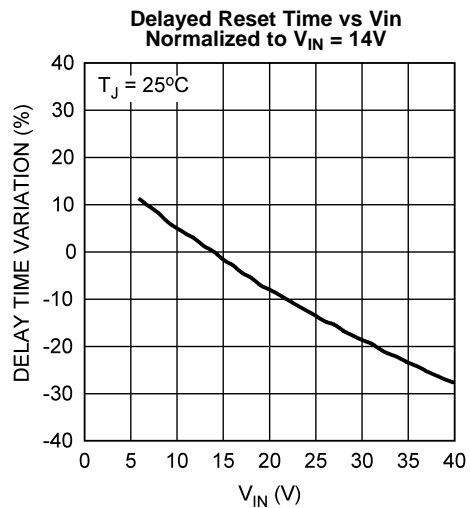

Figure 22.

Typical Performance Characteristics (continued)

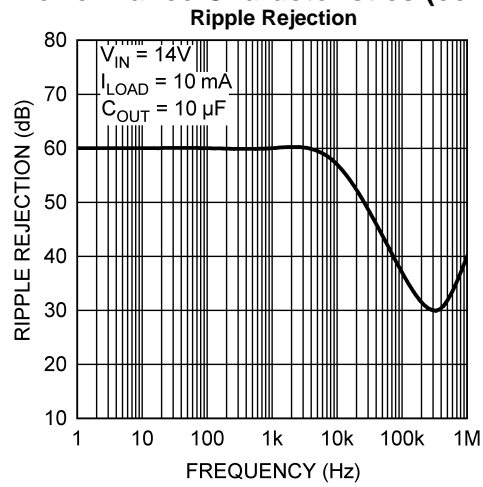

Figure 23.

APPLICATION INFORMATION

REGULATOR BASICS

The LM9076 regulator is suitable for Automotive and Industrial applications where continuous connection to a battery supply is required (refer to [Typical Applications](#)).

The pass element of the regulator is a PNP device which requires an output bypass capacitor for stability. The minimum bypass capacitance for the output is 10 μF (refer to ESR limitations). A 22 μF , or larger, output bypass capacitor is recommended for typical applications

INPUT CAPACITOR

The LM9076 requires a low source impedance to maintain regulator stability because critical portions of the internal bias circuitry are connected directly to V_{IN} . In general, a 10 μF electrolytic capacitor, located within two inches of the LM9076, is adequate for a majority of applications. Additionally, and at a minimum, a 0.1 μF ceramic capacitor should be located between the LM9076 V_{IN} and Ground pin, and as close as is physically possible to the LM9076 itself .

OUTPUT CAPACITOR

An output bypass capacitor is required for stability. This capacitance must be placed between the LM9076 V_{OUT} pin and Ground pin, as close as is physically possible, using traces that are not part of the load current path.

The output capacitor must meet the requirements for minimum capacitance and also maintain the appropriate ESR value across the entire operating ambient temperature range. There is no limit to the maximum output capacitance as long as ESR is maintained.

The minimum bypass capacitance for the output is 10 μF (refer to ESR limitations). A 22 μF , or larger, output bypass capacitor is recommended for typical applications.

Solid tantalums capacitors are recommended as they generally maintain capacitance and ESR ratings over a wide temperature range. Ceramic capacitor types XR7 and XR5 may be used if a series resistor is added to simulate the minimum ESR requirement. See [Figure 24](#).

Aluminum electrolytic capacitors are not recommended as they are subject to wide changes in capacitance and ESR across temperature.

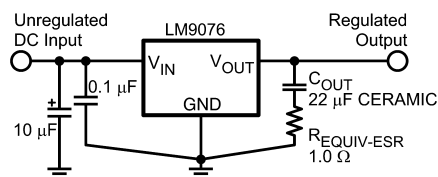

Figure 24. Using Low ESR Capacitors

DELAY CAPACITOR

The capacitor on the Delay pin must be a low leakage type since the charge current is minimal (420 nA typical) and the pin must fully charge to V_{OUT} . Ceramic, Mylar, and polystyrene capacitor types are generally recommended, although changes in capacitance values across temperature changes will have some effect on the delay timing.

Any leakage of the I_{DELAY} current, be it through the delay capacitor or any other path, will extend the delay time, possibly to the point that the Reset pin output does not go high.

SHUTDOWN PIN - LM9076BMA ONLY

The basic On/Off control of the regulator is accomplished with the SHUTDOWN pin. By pulling the SHUTDOWN pin high the regulator output is switched Off. When the regulator is switched Off the load on the battery will be primarily due to the SHUTDOWN pin current.

When the SHUTDOWN pin is low, or left open, the regulator is switched On. When an unregulated supply, such as V BATTERY , is used to pull the SHUTDOWN pin high a series resistor in the range of 10KΩ to 50KΩ is recommended to provide reverse voltage transient protection of the SHUTDOWN pin. Adding a small capacitor (0.001uF typical) from the SHUTDOWN pin to Ground will add noise immunity to prevent accidental turn on due to noise on the supply line.

RESET FLAG

The $\overline{\text{RESET}}$ pin is an open collector output which requires an external pull-up resistor to develop the reset signal. The external pull-up resistor should be in the range of 10 kΩ to 200 kΩ.

At V_{IN} values of less than typically 2V the $\overline{\text{RESET}}$ pin voltage will be high. For V_{IN} values between typically 2V and approximately $V_{\text{OUT}} + V_{\text{BE}}$ the $\overline{\text{RESET}}$ pin voltage will be low. For V_{IN} values greater than approximately $V_{\text{OUT}} + V_{\text{BE}}$ the $\overline{\text{RESET}}$ pin voltage will be dependent on the status of the V_{OUT} pin voltage and the Delayed Reset circuitry. The value of V_{BE} is typically 600 mV at 25°C and will decrease approximately 2 mV for every 1°C increase in the junction temperature. During normal operation the $\overline{\text{RESET}}$ pin voltage will be high .

Any load condition that causes the V_{OUT} pin voltage to drop below typically 89% of normal will activate the Delayed Reset circuit and the $\overline{\text{RESET}}$ pin will go low for the duration of the delay time.

Any line condition that causes V_{IN} pin voltage to drop below typically $V_{\text{OUT}} + V_{\text{BE}}$ will cause the $\overline{\text{RESET}}$ pin to go low without activating the Delayed Reset circuitry.

Excessive thermal dissipation will raise the junction temperature and could activate the Thermal Shutdown circuitry which, in turn, will cause the $\overline{\text{RESET}}$ pin to go low.

For the LM9076BMA devices, pulling the SHUTDOWN pin high will turn off the output which, in turn, will cause the $\overline{\text{RESET}}$ pin to go low once the V_{OUT} voltage has decayed to a value that is less than typically 89% of normal. See [Figure 25](#).

RESET DELAY TIME

When the regulator output is switched On, or after recovery from brief V_{OUT} fault condition, the $\overline{\text{RESET}}$ flag can be programmed to remain low for an additional delay time. This will give time for any system reference voltages, clock signals, etc., to stabilize before the micro-controller resumes normal operation.

This delay time is controlled by the capacitor value on the C_{DELAY} pin. During normal operation the C_{DELAY} capacitor is charged to near V_{OUT} . When a V_{OUT} fault causes the $\overline{\text{RESET}}$ pin to go low, the C_{DELAY} capacitor is quickly discharged to ground. When the V_{OUT} fault is removed, and V_{OUT} returns to the normal operating value, the C_{DELAY} capacitor begins charging at a typical constant 0.420 uA rate. When the voltage on the C_{DELAY} capacitor reaches the same potential as the V_{OUT} pin the $\overline{\text{RESET}}$ pin will be allowed to return high.

The typical $\overline{\text{RESET}}$ delay time can be calculated with the following formula:

$$t_{\text{DELAY}} = V_{\text{OUT}} \times (C_{\text{DELAY}} / I_{\text{DELAY}}) \quad (1)$$

For the LM9076–3.3 with a C_{DELAY} value of 0.001 uF and a I_{DELAY} value of 0.420 uA the typical $\overline{\text{RESET}}$ delay time is:

$$t_{\text{DELAY}} = 3.3\text{V} \times (0.001 \text{ uF} / 0.420 \text{ uA}) = 7.8 \text{ ms} \quad (2)$$

For the LM9076–5.0 with a C_{DELAY} value of 0.001 uF and a I_{DELAY} value of 0.420 uA the typical $\overline{\text{RESET}}$ delay time is:

$$t_{\text{DELAY}} = 5.0\text{V} \times (0.001\text{uF} / 0.420\text{uA}) = 11.9 \text{ ms} \quad (3)$$

THERMAL PROTECTION

Device operational range is limited by the maximum junction temperature (T_J). The junction temperature is influenced by the ambient temperature (T_A), package selection, input voltage (V_{IN}), and the output load current. When operating with maximum load currents the input voltage and/or ambient temperature will be limited. When operating with maximum input voltage the load current and/or the ambient temperature will be limited.

Even though the LM9076 is equipped with circuitry to protect itself from excessive thermal dissipation, it is not recommended that the LM9076 be operated at, or near, the maximum recommended die junction temperature (T_J) as this may impair long term device reliability.

The thermal protection circuitry monitors the temperature at the die level. When the die temperature exceeds typically 160°C the voltage regulator output will be switched off.

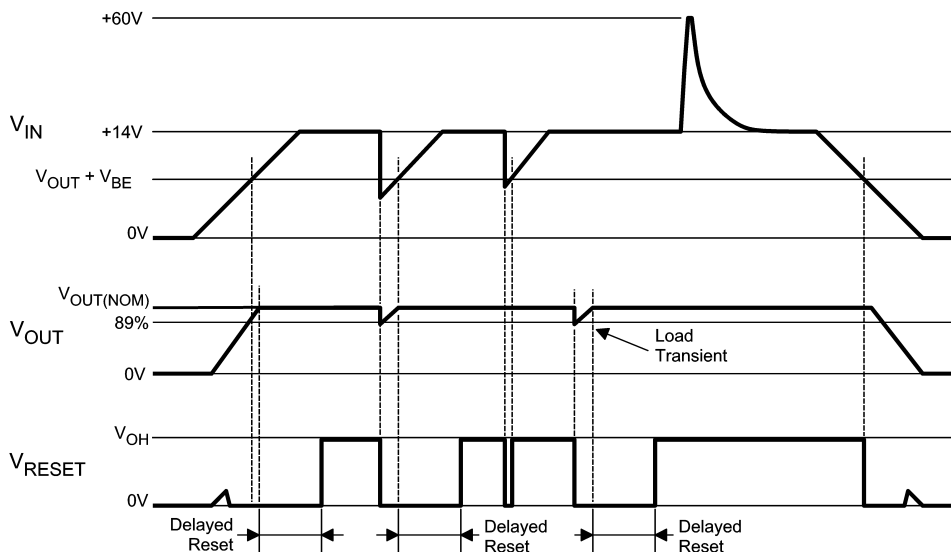

Figure 25. Typical $\overline{\text{RESET}}$ Pin Operational Waveforms

REVISION HISTORY

Changes from Revision K (March 2013) to Revision L	Page
<ul style="list-style-type: none">• Changed layout of National Data Sheet to TI format	12

PACKAGING INFORMATION

Orderable Device	Status (1)	Package Type	Package Drawing	Pins	Package Qty	Eco Plan (2)	Lead/Ball Finish (6)	MSL Peak Temp (3)	Op Temp (°C)	Device Marking (4/5)	Samples
LM9076BMA-3.3/NOPB	ACTIVE	SOIC	D	8	95	Green (RoHS & no Sb/Br)	CU SN	Level-1-260C-UNLIM	-40 to 125	9076B MA3.3	Samples
LM9076BMA-5.0	NRND	SOIC	D	8	95	TBD	Call TI	Call TI	-40 to 125	9076B MA5.0	
LM9076BMA-5.0/NOPB	ACTIVE	SOIC	D	8	95	Green (RoHS & no Sb/Br)	CU SN	Level-1-260C-UNLIM	-40 to 125	9076B MA5.0	Samples
LM9076BMAX-3.3/NOPB	ACTIVE	SOIC	D	8	2500	Green (RoHS & no Sb/Br)	CU SN	Level-1-260C-UNLIM	-40 to 125	9076B MA3.3	Samples
LM9076BMAX-5.0/NOPB	ACTIVE	SOIC	D	8	2500	Green (RoHS & no Sb/Br)	CU SN	Level-1-260C-UNLIM	-40 to 125	9076B MA5.0	Samples
LM9076S-3.3/NOPB	ACTIVE	DDPAK/ TO-263	KTT	5	45	Pb-Free (RoHS Exempt)	CU SN	Level-3-245C-168 HR	-40 to 125	LM9076S -3.3	Samples
LM9076S-5.0	NRND	DDPAK/ TO-263	KTT	5	45	TBD	Call TI	Call TI	-40 to 125	LM9076S -5.0	
LM9076S-5.0/NOPB	ACTIVE	DDPAK/ TO-263	KTT	5	45	Pb-Free (RoHS Exempt)	CU SN	Level-3-245C-168 HR	-40 to 125	LM9076S -5.0	Samples
LM9076SX-3.3/NOPB	ACTIVE	DDPAK/ TO-263	KTT	5	500	Pb-Free (RoHS Exempt)	CU SN	Level-3-245C-168 HR	-40 to 125	LM9076S -3.3	Samples
LM9076SX-5.0/NOPB	ACTIVE	DDPAK/ TO-263	KTT	5	500	Pb-Free (RoHS Exempt)	CU SN	Level-3-245C-168 HR	-40 to 125	LM9076S -5.0	Samples

(1) The marketing status values are defined as follows:

ACTIVE: Product device recommended for new designs.

LIFEBUY: TI has announced that the device will be discontinued, and a lifetime-buy period is in effect.

NRND: Not recommended for new designs. Device is in production to support existing customers, but TI does not recommend using this part in a new design.

PREVIEW: Device has been announced but is not in production. Samples may or may not be available.

OBSELETE: TI has discontinued the production of the device.

(2) Eco Plan - The planned eco-friendly classification: Pb-Free (RoHS), Pb-Free (RoHS Exempt), or Green (RoHS & no Sb/Br) - please check <http://www.ti.com/productcontent> for the latest availability information and additional product content details.

TBD: The Pb-Free/Green conversion plan has not been defined.

Pb-Free (RoHS): TI's terms "Lead-Free" or "Pb-Free" mean semiconductor products that are compatible with the current RoHS requirements for all 6 substances, including the requirement that lead not exceed 0.1% by weight in homogeneous materials. Where designed to be soldered at high temperatures, TI Pb-Free products are suitable for use in specified lead-free processes.

Pb-Free (RoHS Exempt): This component has a RoHS exemption for either 1) lead-based flip-chip solder bumps used between the die and package, or 2) lead-based die adhesive used between the die and leadframe. The component is otherwise considered Pb-Free (RoHS compatible) as defined above.

Green (RoHS & no Sb/Br): TI defines "Green" to mean Pb-Free (RoHS compatible), and free of Bromine (Br) and Antimony (Sb) based flame retardants (Br or Sb do not exceed 0.1% by weight in homogeneous material)

- (3) MSL, Peak Temp. - The Moisture Sensitivity Level rating according to the JEDEC industry standard classifications, and peak solder temperature.
- (4) There may be additional marking, which relates to the logo, the lot trace code information, or the environmental category on the device.
- (5) Multiple Device Markings will be inside parentheses. Only one Device Marking contained in parentheses and separated by a "~" will appear on a device. If a line is indented then it is a continuation of the previous line and the two combined represent the entire Device Marking for that device.
- (6) Lead/Ball Finish - Orderable Devices may have multiple material finish options. Finish options are separated by a vertical ruled line. Lead/Ball Finish values may wrap to two lines if the finish value exceeds the maximum column width.

Important Information and Disclaimer:The information provided on this page represents TI's knowledge and belief as of the date that it is provided. TI bases its knowledge and belief on information provided by third parties, and makes no representation or warranty as to the accuracy of such information. Efforts are underway to better integrate information from third parties. TI has taken and continues to take reasonable steps to provide representative and accurate information but may not have conducted destructive testing or chemical analysis on incoming materials and chemicals. TI and TI suppliers consider certain information to be proprietary, and thus CAS numbers and other limited information may not be available for release.

In no event shall TI's liability arising out of such information exceed the total purchase price of the TI part(s) at issue in this document sold by TI to Customer on an annual basis.

TAPE AND REEL INFORMATION



QUADRANT ASSIGNMENTS FOR PIN 1 ORIENTATION IN TAPE



*All dimensions are nominal

Device	Package Type	Package Drawing	Pins	SPQ	Reel Diameter (mm)	Reel Width W1 (mm)	A0 (mm)	B0 (mm)	K0 (mm)	P1 (mm)	W (mm)	Pin1 Quadrant
LM9076BMAX-3.3/NOPB	SOIC	D	8	2500	330.0	12.4	6.5	5.4	2.0	8.0	12.0	Q1
LM9076BMAX-5.0/NOPB	SOIC	D	8	2500	330.0	12.4	6.5	5.4	2.0	8.0	12.0	Q1
LM9076SX-3.3/NOPB	DDPAK/ TO-263	KTT	5	500	330.0	24.4	10.75	14.85	5.0	16.0	24.0	Q2
LM9076SX-5.0/NOPB	DDPAK/ TO-263	KTT	5	500	330.0	24.4	10.75	14.85	5.0	16.0	24.0	Q2

TAPE AND REEL BOX DIMENSIONS

*All dimensions are nominal

Device	Package Type	Package Drawing	Pins	SPQ	Length (mm)	Width (mm)	Height (mm)
LM9076BMAX-3.3/NOPB	SOIC	D	8	2500	367.0	367.0	35.0
LM9076BMAX-5.0/NOPB	SOIC	D	8	2500	367.0	367.0	35.0
LM9076SX-3.3/NOPB	DDPAK/TO-263	KTT	5	500	367.0	367.0	45.0
LM9076SX-5.0/NOPB	DDPAK/TO-263	KTT	5	500	367.0	367.0	45.0

D (R-PDSO-G8)

PLASTIC SMALL OUTLINE



NOTES: A. All linear dimensions are in inches (millimeters).
 B. This drawing is subject to change without notice.
 C. Body length does not include mold flash, protrusions, or gate burrs. Mold flash, protrusions, or gate burrs shall not exceed 0.006 (0,15) each side.
 D. Body width does not include interlead flash. Interlead flash shall not exceed 0.017 (0,43) each side.
 E. Reference JEDEC MS-012 variation AA.

KTT0005B



IMPORTANT NOTICE

Texas Instruments Incorporated and its subsidiaries (TI) reserve the right to make corrections, enhancements, improvements and other changes to its semiconductor products and services per JESD46, latest issue, and to discontinue any product or service per JESD48, latest issue. Buyers should obtain the latest relevant information before placing orders and should verify that such information is current and complete. All semiconductor products (also referred to herein as "components") are sold subject to TI's terms and conditions of sale supplied at the time of order acknowledgment.

TI warrants performance of its components to the specifications applicable at the time of sale, in accordance with the warranty in TI's terms and conditions of sale of semiconductor products. Testing and other quality control techniques are used to the extent TI deems necessary to support this warranty. Except where mandated by applicable law, testing of all parameters of each component is not necessarily performed.

TI assumes no liability for applications assistance or the design of Buyers' products. Buyers are responsible for their products and applications using TI components. To minimize the risks associated with Buyers' products and applications, Buyers should provide adequate design and operating safeguards.

TI does not warrant or represent that any license, either express or implied, is granted under any patent right, copyright, mask work right, or other intellectual property right relating to any combination, machine, or process in which TI components or services are used. Information published by TI regarding third-party products or services does not constitute a license to use such products or services or a warranty or endorsement thereof. Use of such information may require a license from a third party under the patents or other intellectual property of the third party, or a license from TI under the patents or other intellectual property of TI.

Reproduction of significant portions of TI information in TI data books or data sheets is permissible only if reproduction is without alteration and is accompanied by all associated warranties, conditions, limitations, and notices. TI is not responsible or liable for such altered documentation. Information of third parties may be subject to additional restrictions.

Resale of TI components or services with statements different from or beyond the parameters stated by TI for that component or service voids all express and any implied warranties for the associated TI component or service and is an unfair and deceptive business practice. TI is not responsible or liable for any such statements.

Buyer acknowledges and agrees that it is solely responsible for compliance with all legal, regulatory and safety-related requirements concerning its products, and any use of TI components in its applications, notwithstanding any applications-related information or support that may be provided by TI. Buyer represents and agrees that it has all the necessary expertise to create and implement safeguards which anticipate dangerous consequences of failures, monitor failures and their consequences, lessen the likelihood of failures that might cause harm and take appropriate remedial actions. Buyer will fully indemnify TI and its representatives against any damages arising out of the use of any TI components in safety-critical applications.

In some cases, TI components may be promoted specifically to facilitate safety-related applications. With such components, TI's goal is to help enable customers to design and create their own end-product solutions that meet applicable functional safety standards and requirements. Nonetheless, such components are subject to these terms.

No TI components are authorized for use in FDA Class III (or similar life-critical medical equipment) unless authorized officers of the parties have executed a special agreement specifically governing such use.

Only those TI components which TI has specifically designated as military grade or "enhanced plastic" are designed and intended for use in military/aerospace applications or environments. Buyer acknowledges and agrees that any military or aerospace use of TI components which have **not** been so designated is solely at the Buyer's risk, and that Buyer is solely responsible for compliance with all legal and regulatory requirements in connection with such use.

TI has specifically designated certain components as meeting ISO/TS16949 requirements, mainly for automotive use. In any case of use of non-designated products, TI will not be responsible for any failure to meet ISO/TS16949.

Products

Audio	www.ti.com/audio
Amplifiers	amplifier.ti.com
Data Converters	dataconverter.ti.com
DLP® Products	www.dlp.com
DSP	dsp.ti.com
Clocks and Timers	www.ti.com/clocks
Interface	interface.ti.com
Logic	logic.ti.com
Power Mgmt	power.ti.com
Microcontrollers	microcontroller.ti.com
RFID	www.ti-rfid.com
OMAP Applications Processors	www.ti.com/omap
Wireless Connectivity	www.ti.com/wirelessconnectivity

Applications

Automotive and Transportation	www.ti.com/automotive
Communications and Telecom	www.ti.com/communications
Computers and Peripherals	www.ti.com/computers
Consumer Electronics	www.ti.com/consumer-apps
Energy and Lighting	www.ti.com/energy
Industrial	www.ti.com/industrial
Medical	www.ti.com/medical
Security	www.ti.com/security
Space, Avionics and Defense	www.ti.com/space-avionics-defense
Video and Imaging	www.ti.com/video

TI E2E Community

e2e.ti.com