



LMZ20502 2 A SIMPLE SWITCHER® Nano Module

1 Features

- Integrated Inductor
- Miniature 3.5 mm x 3.5 mm x 1.75 mm Package
- 2 A Maximum Load Current
- Input Voltage Range of 2.7 V to 5.5 V
- Adjustable Output Voltage Range of 0.8 V to 3.6 V
- $\pm 1\%$ Feedback Tolerance Over Temperature
- 2.4 μA (max) Quiescent Current In Shutdown
- 3 MHz Fixed PWM Switching Frequency
- -40°C to 125°C Junction Temperature Range
- Power Good Flag Function
- Pin-Selectable Switching Modes
- Internal Compensation and Soft-Start
- Current Limit, Thermal Shutdown, and UVLO Protection

2 Applications

- Point of Load Regulation
- Space Constrained Applications

3 Description

The LMZ20502 SIMPLE SWITCHER® Nano Module regulator is an easy-to-use synchronous step-down DC-DC converter capable of driving up to 2 A of load from an input of up to 5.5 V, with exceptional efficiency and output accuracy in a very small solution size. The innovative package contains the regulator and inductor in a small 3.5 mm x 3.5 mm x 1.75 mm volume, thus saving board space and eliminating the time and expense of inductor selection. The LMZ20502 requires only five external components and has a pin-out designed for simple, optimum PCB layout. The LMZ20502 is a member of Texas Instruments' SIMPLE SWITCHER family. The SIMPLE SWITCHER concept provides for an easy to use complete design with a minimum number of external components and the TI WEBENCH® design tool. TI's WEBENCH tool includes features such as external component calculation, electrical simulation, and WebTherm™. For soldering information, please refer to the following document: [SNOA401](#).

Device Information⁽¹⁾

PART NUMBER	PACKAGE / DRAWING	BODY SIZE (NOM)
LMZ20502SILT	USIP (8) / SIL0008F	3.50 mm x 3.50 mm

(1) For all available packages, see the orderable addendum at the end of the datasheet.

4 Simplified Schematic

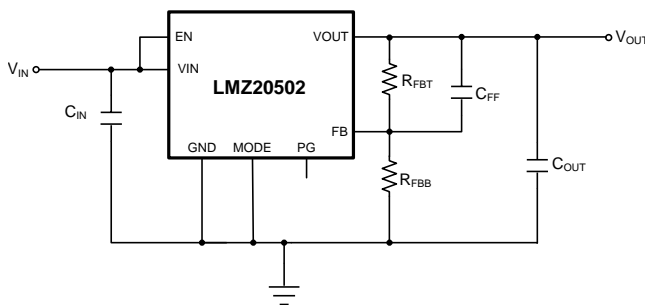

Typical Efficiency for $V_{\text{OUT}} = 1.8\text{ V}$ Auto Mode

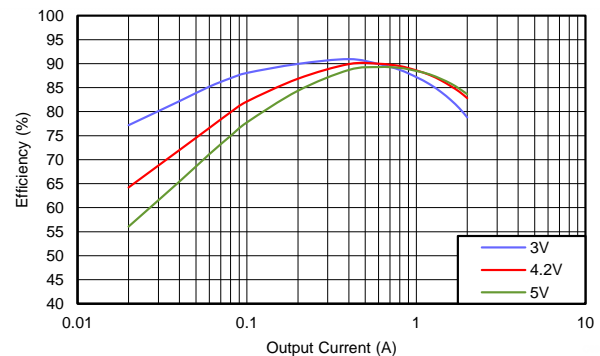

Table of Contents

1 Features	1	8.4 Device Functional Modes.....	13
2 Applications	1	9 Application and Implementation	15
3 Description	1	9.1 Application Information.....	15
4 Simplified Schematic	1	9.2 Typical Application	16
5 Revision History	2	9.3 Do's and Don'ts	23
6 Pin Configuration and Functions	3	10 Power Supply Recommendations	23
7 Specifications	4	11 Layout	24
7.1 Absolute Maximum Ratings	4	11.1 Layout Guidelines	24
7.2 ESD Ratings	4	11.2 Layout Example	25
7.3 Recommended Operating Conditions.....	4	11.3 Soldering Information.....	25
7.4 Thermal Information	5	12 Device and Documentation Support	27
7.5 Electrical Characteristics.....	6	12.1 Device Support.....	27
7.6 System Characteristics	7	12.2 Trademarks	27
7.7 Typical Characteristics.....	8	12.3 Electrostatic Discharge Caution.....	27
8 Detailed Description	9	12.4 Glossary	27
8.1 Overview	9	13 Mechanical, Packaging, and Orderable Information	28
8.2 Functional Block Diagram	9	13.1 Package Option Addendum	29
8.3 Feature Description.....	9		

5 Revision History

Changes from Revision B (December 2014) to Revision C	Page
• Added the package option addendum manually	1

Changes from Revision A (July 2013) to Revision B	Page
• Changed <i>Device Information</i> and <i>Handling Rating</i> tables, <i>Feature Description</i> , <i>Device Functional Modes</i> , <i>Application and Implementation</i> , <i>Power Supply Recommendations</i> , <i>Layout</i> , <i>Device and Documentation Support</i> , and <i>Mechanical, Packaging, and Orderable Information</i> sections; moved some curves to <i>Application Curves</i> section	1

6 Pin Configuration and Functions

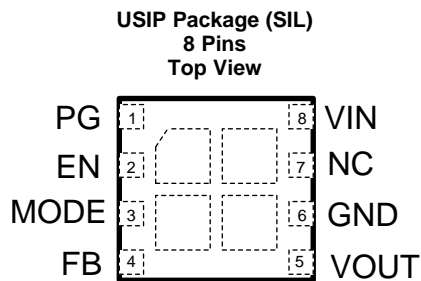

PIN		TYPE ⁽¹⁾	DESCRIPTION
NUMBER	NAME		
1	PG	O	Power good flag; open drain. Connect to logic supply through a resistor. High = power good; Low = power bad. If not used, leave unconnected.
2	EN	I	Enable input. High = On, Low = Off. A valid input voltage, on pin 8, must be present before EN is asserted. Do not float.
3	MODE	I	Mode selection input. High = forced PWM. Low = AUTO mode, with PFM at light load. Do not float.
4	FB	I	Feedback input to controller. Connect to output through feedback divider.
5	VOUT	P	Regulated output voltage; connect to C _{OUT} .
6	GND	G	Ground for all circuitry. Reference point for all voltages.
7	NC		This pin must be left floating. Do not connect to ground or any other node.
8	VIN	P	Input supply to regulator. Connect to input capacitor(s) as close as possible to the VIN pin and GND pin of the module.
EP	EP	G	Ground and heat-sink connection. See Layout Guidelines section for more information.

(1) G = Ground, I = Input, O = Output, P = Power

7 Specifications

7.1 Absolute Maximum Ratings

Under the recommended operating junction temperature range of -40°C to 125°C (unless otherwise noted) ⁽¹⁾

	MIN	MAX	UNIT
V _{IN} to GND	-0.2	6	V
EN, MODE, FB, PG, to GND ⁽²⁾	-0.2	V _{IN} +0.2	
V _{OUT} to GND ⁽²⁾	-0.2	V _{IN} +0.2	
Junction temperature		150	°C
Peak soldering reflow temperature for Pb ⁽³⁾		240	°C
Peak soldering reflow temperature for No-Pb ⁽³⁾		260	
Storage temperature range	-65	150	°C

- (1) Stresses beyond those listed under *Absolute Maximum Ratings* may cause permanent damage to the device. These are stress ratings only, which do not imply functional operation of the device at these or any other conditions beyond those indicated under *Recommended Operating Conditions*. Exposure to absolute-maximum-rated conditions for extended periods may affect device reliability.
- (2) The absolute maximum voltage on this pin must not exceed 6V with respect to ground. Do not allow the voltage on the output pin to exceed the voltage on the input pin by more than 0.2 V.
- (3) For soldering information, please refer to the following document: [SNOA401](#).

7.2 ESD Ratings

			VALUE	UNIT
V _(ESD)	Electrostatic discharge	Human body model (HBM), per ANSI/ESDA/JEDEC JS-001, all pins ⁽¹⁾	±2000	V
		Charged-device model (CDM), per JEDEC specification JESD22-C101, all pins ⁽²⁾	±500	

- (1) JEDEC document JEP155 states that 500-V HBM allows safe manufacturing with a standard ESD control process.
- (2) JEDEC document JEP157 states that 250-V CDM allows safe manufacturing with a standard ESD control process.

7.3 Recommended Operating Conditions

Under the recommended operating junction temperature range of -40°C to 125°C (unless otherwise noted) ⁽¹⁾

	MIN	NOM	MAX	UNIT
Input voltage	2.7		5.5	V
Output voltage programming	0.8		3.6	V
Output voltage range ⁽²⁾	0		3.6	V
Load current	0		2	A
Power good flag current	0		4	mA
Junction temperature	-40		125	°C

- (1) Stresses beyond those listed under *Absolute Maximum Ratings* may cause permanent damage to the device. These are stress ratings only, which do not imply functional operation of the device at these or any other conditions beyond those indicated under *Recommended Operating Conditions*. Exposure to absolute-maximum-rated conditions for extended periods may affect device reliability.
- (2) Under no conditions should the output voltage be allowed to fall below zero volts.

7.4 Thermal Information

THERMAL METRIC ⁽¹⁾		LMZ20502	UNIT
		USIP (SIL)	
		8 PINS	
$R_{\theta JA}$	Junction-to-ambient thermal resistance	42.6	°C/W
$R_{\theta JC(top)}$	Junction-to-case (top) thermal resistance	20.8	
$R_{\theta JB}$	Junction-to-board thermal resistance	9.4	
Ψ_{JT}	Junction-to-top characterization parameter	1.5	
Ψ_{JB}	Junction-to-board characterization parameter	9.3	
$R_{\theta JC(bot)}$	Junction-to-case (bottom) thermal resistance	1.8	

- (1) The values given in this table are only valid for comparison with other packages and can not be used for design purposes. For design information please see the [Maximum Ambient Temperature](#) section. For more information about traditional and new thermal metrics, see the *IC Package Thermal Metrics* application report, [SPRA953](#).

7.5 Electrical Characteristics

Limits apply over the recommended operating junction temperature range of -40°C to 125°C , unless otherwise noted. Minimum and maximum limits are verified through test, design, or statistical correlation. Typical values represent the most likely parametric norm at $T_J = 25^{\circ}\text{C}$, and are provided for reference purposes only. Unless otherwise stated the following conditions apply: $V_{IN} = 3.6\text{ V}$

PARAMETER	TEST CONDITIONS	MIN ⁽¹⁾	TYP	MAX ⁽¹⁾	UNIT	
V_{FB}	Feedback voltage	$V_{IN} = 3.6\text{ V}$	0.594	0.6	0.606	V
I_{Q_AUTO}	Operating quiescent current in AUTO mode	AUTO mode, $V_{FB} = 0.8\text{ V}$	72	90		μA
I_{Q_PWM}	Operating quiescent current in forced PWM mode	PWM mode, $V_{FB} = 0.8\text{ V}$	490	620		μA
I_{Q_off}	Shutdown quiescent current ⁽²⁾	$V_{IN} = 3.6\text{ V}$, $V_{EN} = 0.0\text{ V}$	0.7	1.5		μA
		$V_{IN} = 5.5\text{ V}$, $V_{EN} = 0.0\text{ V}$	1.0	2.4		
V_{UVLO}	Input supply under-voltage lock-out thresholds	Rising	2.5			V
		Falling	2.3			
V_{EN}	High Level Input Voltage	V_{IH}	1.4			V
	Low Level Input Voltage	V_{IL}		0.4		
V_{MODE}	High Level Input Voltage	V_{IH}	1.2			V
	Low Level Input Voltage	V_{IL}		0.4		
I_{LIM}	Peak switch current limit ⁽³⁾		2.1	2.7		A
F_{osc}	Internal oscillator frequency		2.5	3.0	3.2	MHz
T_{ON}	Minimum switch on-time ⁽⁴⁾		50			ns
T_{ss}	Soft start time ⁽⁴⁾		800			μs
R_{PG}	Power good flag pull-down R_{dson}		40	70	110	Ω
V_{PG1}	Power good flag, under-voltage trip ⁽⁵⁾	% of feedback voltage, rising	92%			
V_{PG2}	Power good flag, under-voltage trip ⁽⁵⁾	% of feedback voltage, falling	88%			
V_{PG3}	Power good flag, over-voltage trip ⁽⁵⁾	% of feedback voltage, rising	112%			
V_{PG4}	Power good flag, over-voltage trip ⁽⁵⁾	% of feedback voltage, falling	108%			
T_{SD}	Thermal shutdown ⁽⁴⁾	Rising threshold	159			$^{\circ}\text{C}$
	Thermal shutdown hysteresis ⁽⁴⁾		15			$^{\circ}\text{C}$

- (1) MIN and MAX limits are 100% production tested at 25°C . Limits over the operating temperature range are verified through correlation using Statistical Quality Control (SQC) methods. Limits are used to calculate Average Outgoing Quality Level (AOQL).
- (2) Shutdown current includes leakage current of the switching transistors.
- (3) This is the peak switch current limit measured with a slow current ramp. Due to inherent delays in the current limit comparator, the peak current limit measured at 3MHz will be larger.
- (4) This parameter is not tested in production.
- (5) See [Power Good Flag Function](#) for explanation of voltage levels.

7.6 System Characteristics

The following specifications apply to the circuit found in [Figure 16](#) with the appropriate modifications from [Table 2](#). **These parameters are not tested in production and represent typical performance only.** Unless otherwise stated the following conditions apply: $T_A = 25^\circ\text{C}$.

PARAMETER		TEST CONDITIONS	MIN	TYP	MAX	UNIT
Load Regulation	Percent output voltage change for the given load current change	$V_{OUT} = 1.2\text{ V}$, $V_{IN} = 5\text{ V}$, $I_{OUT} = 0\text{ A to } 2\text{ A}$, PWM		0.4%		
		$V_{OUT} = 1.8\text{ V}$ $V_{IN} = 5\text{ V}$, $I_{OUT} = 0\text{ A to } 2\text{ A}$, PWM		0.4%		
		$V_{OUT} = 3.3\text{ V}$ $V_{IN} = 5\text{ V}$, $I_{OUT} = 0\text{ A to } 2\text{ A}$, PWM		0.2%		
Line Regulation	Percent output voltage change for the given change in input voltage	$V_{OUT} = 1.2\text{ V}$ $I_{OUT} = 2\text{ A}$, $V_{IN} = 3\text{ V to } 5\text{ V}$, PWM		0.2%		
		$V_{OUT} = 1.8\text{ V}$ $I_{OUT} = 2\text{ A}$, $V_{IN} = 3\text{ V to } 5\text{ V}$, PWM		0.15%		
		$V_{OUT} = 3.3\text{ V}$ $I_{OUT} = 2\text{ A}$, $V_{IN} = 4\text{ V to } 5\text{ V}$, PWM		0.18%		
V_{R-PWM}	Output voltage ripple in PWM	$V_{OUT} = 1.2\text{ V}$ $I_{OUT} = 1\text{ A}$, $V_{IN} = 5\text{ V}$, PWM		3.3		mV pk-pk
		$V_{OUT} = 1.8\text{ V}$ $I_{OUT} = 1\text{ A}$, $V_{IN} = 5\text{ V}$, PWM		3.3		
		$V_{OUT} = 3.3\text{ V}$ $I_{OUT} = 1\text{ A}$, $V_{IN} = 5\text{ V}$, PWM		4.2		
V_{R-PFM}	Output voltage ripple in PFM	$V_{OUT} = 1.2\text{ V}$ $I_{OUT} = 1\text{ mA}$, $V_{IN} = 3\text{ V}$, PFM		22		mV pk-pk
		$V_{OUT} = 1.8\text{ V}$ $I_{OUT} = 1\text{ mA}$, $V_{IN} = 3\text{ V}$, PFM		22		
		$V_{OUT} = 3.3\text{ V}$ $I_{OUT} = 1\text{ mA}$, $V_{IN} = 5\text{ V}$, PFM		40		
Load Transient	Output voltage deviation from nominal due to a load current step	$V_{OUT} = 1.2\text{ V}$ $V_{IN} = 5\text{ V}$, $I_{OUT} = 0\text{ A to } 2\text{ A}$, $T_r = T_f = 2\text{ }\mu\text{s}$, PWM		± 115		mV
		$V_{OUT} = 1.8\text{ V}$ $V_{IN} = 5\text{ V}$, $I_{OUT} = 0\text{ A to } 2\text{ A}$, $T_r = T_f = 2\text{ }\mu\text{s}$, PWM		± 100		
		$V_{OUT} = 3.3\text{ V}$ $V_{IN} = 5\text{ V}$, $I_{OUT} = 0\text{ A to } 2\text{ A}$, $T_r = T_f = 2\text{ }\mu\text{s}$, PWM		± 150		
Line Transient	Output voltage deviation due to an input voltage step	$V_{OUT} = 1.2\text{ V}$ $I_{OUT} = 1\text{ A}$, $V_{IN} = 3\text{ V to } 5\text{ V}$, $T_r = T_f = 50\text{ }\mu\text{s}$, PWM		25		mV pk-pk
		$V_{OUT} = 1.8\text{ V}$ $I_{OUT} = 1\text{ A}$, $V_{IN} = 3\text{ V to } 5\text{ V}$, $T_r = T_f = 50\text{ }\mu\text{s}$, PWM		30		
		$V_{OUT} = 3.3\text{ V}$ $I_{OUT} = 1\text{ A}$, $V_{IN} = 4\text{ V to } 5\text{ V}$, $T_r = T_f = 50\text{ }\mu\text{s}$, PWM		20		
η	Peak efficiency	$V_{OUT} = 1.2\text{ V}$ $V_{IN} = 3\text{ V}$		87%		
		$V_{OUT} = 1.8\text{ V}$ $V_{IN} = 3\text{ V}$		91%		
		$V_{OUT} = 3.3\text{ V}$ $V_{IN} = 4.2\text{ V}$		94%		
	Full load efficiency	$V_{OUT} = 1.2\text{ V}$ $V_{IN} = 3\text{ V}$, $I_{OUT} = 2\text{ A}$		74%		
		$V_{OUT} = 1.8\text{ V}$ $V_{IN} = 3\text{ V}$, $I_{OUT} = 2\text{ A}$		79%		
		$V_{OUT} = 3.3\text{ V}$ $V_{IN} = 4.2\text{ V}$, $I_{OUT} = 2\text{ A}$		89%		

7.7 Typical Characteristics

Unless otherwise specified the following conditions apply: $V_{IN} = 3.6\text{ V}$, $T_A = 25^\circ\text{C}$.

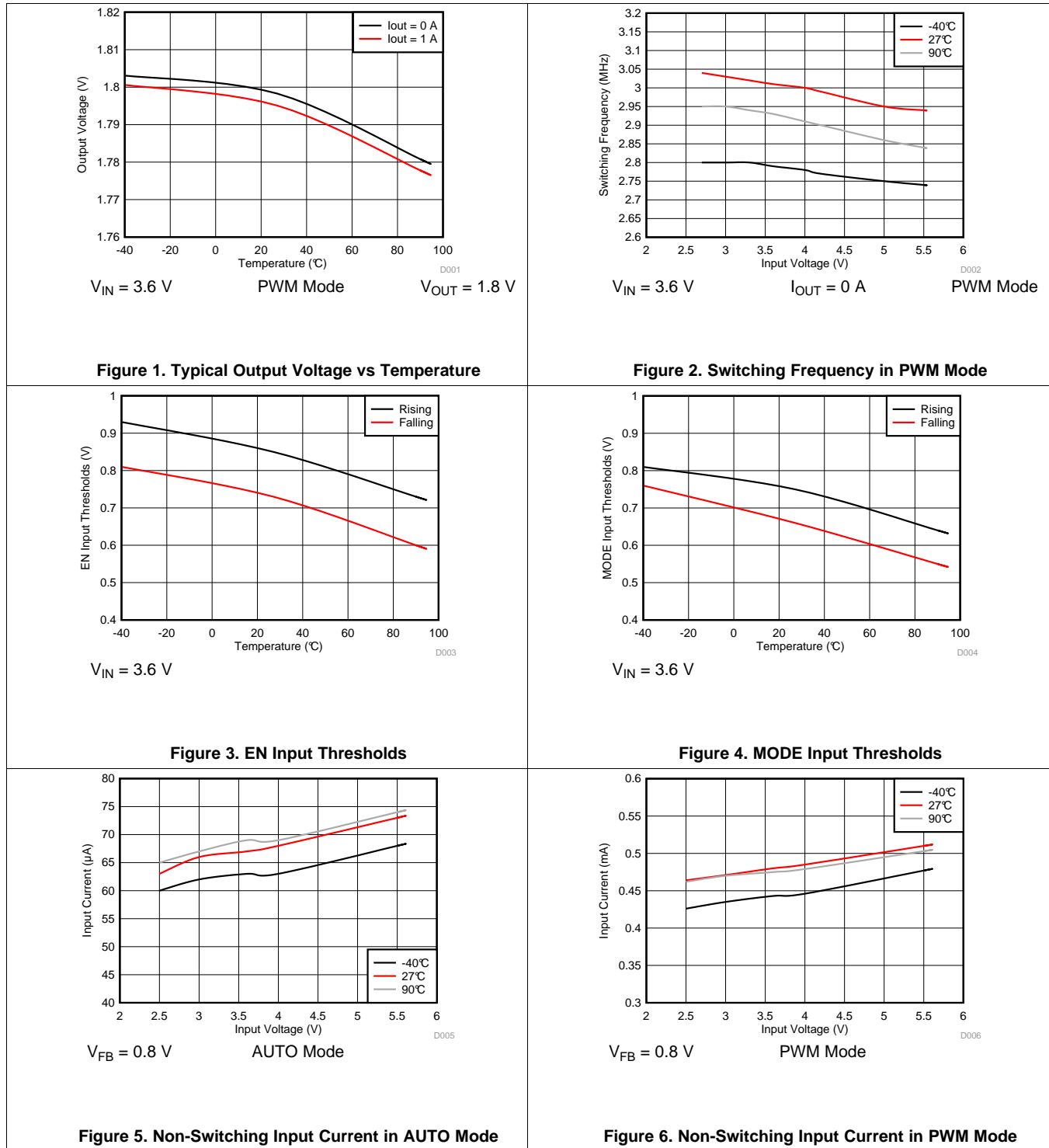

8 Detailed Description

8.1 Overview

The LMZ20502 SIMPLE SWITCHER Nano Module is a voltage mode buck regulator with an integrated inductor. Input voltage feed-forward is used to compensate for loop gain variation with input voltage. Two operating modes allow the user to tailor the regulator to their specific requirements. In forced PWM mode, the regulator operates as a full synchronous device with a 3 MHz (typ.) switching frequency and very low output voltage ripple. In AUTO mode, the regulator moves into PFM when the load current drops below the mode change threshold (see [Application Curves](#)). In PFM, the device regulates the output voltage between wider ripple limits than in PWM. This results in much smaller supply current than in PWM, at light loads and high efficiency. A simplified block diagram is shown in [Functional Block Diagram](#).

8.2 Functional Block Diagram

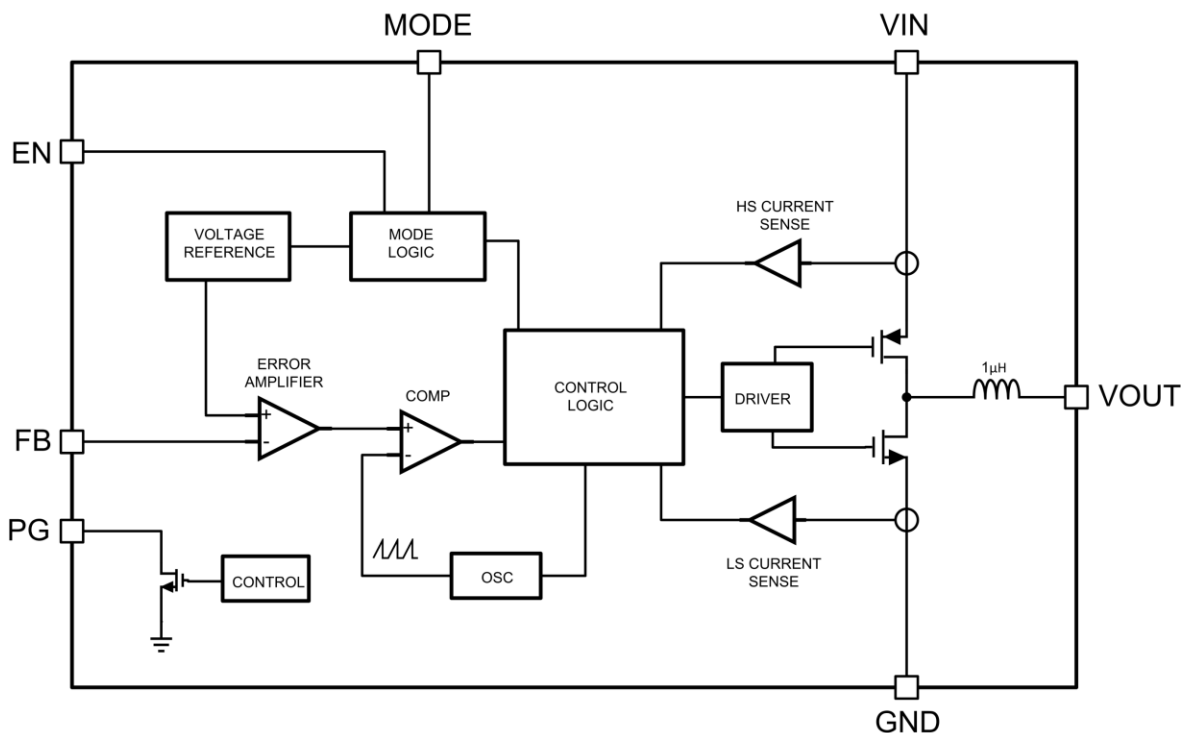

8.3 Feature Description

8.3.1 Nano Scale Package

The LMZ20502 incorporates world class package technology to provide a 2 A power supply with a total volume of only 21 mm³ (excluding external components). All that is required for a complete power supply is the addition of feed-back resistors to set the output voltage and the input and output filter capacitors. [Figure 7](#) and [Figure 8](#) show the LMZ20502 package. The regulator die is embedded into a PCB substrate while the power inductor is mounted on top. Vias and copper clad are used to make the connections to the die, inductor and the external components. This package is MSL3 compliant.

Feature Description (continued)

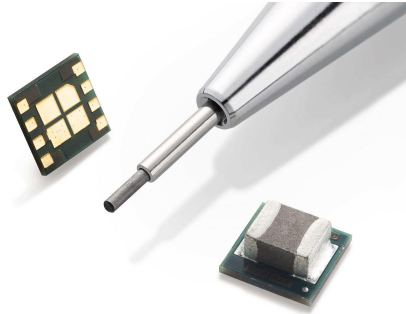

Figure 7. Package Photo

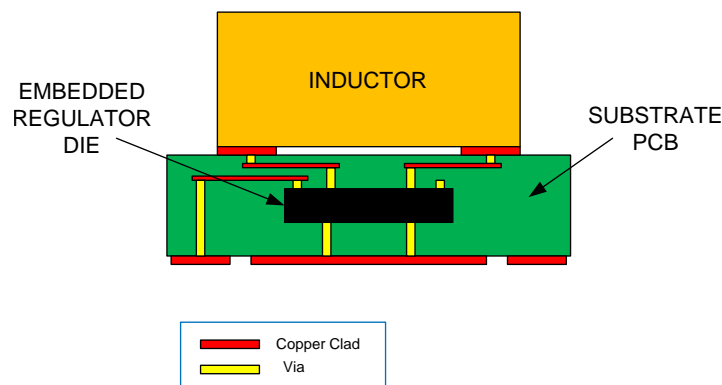

Figure 8. Package Side View Drawing

8.3.2 Internal Synchronous Rectifier

The LMZ20502 uses an internal NMOS FET as a synchronous rectifier to minimize switch voltage drop and increase efficiency. The NMOS is designed to conduct through its body diode during switch dead time. This dead time is imposed to prevent supply current "shoot-through".

8.3.3 Current Limit Protection

The LMZ20502 incorporates cycle-by-cycle peak current limit on both the high and low side MOSFETs. This feature limits the output current in case the output is overloaded. During the overload, the peak inductor current is limited to that value found in the [Electrical Characteristics](#) table under the heading of " I_{LIM} ".

In addition to current limit, a short circuit protection mode is also implemented. When the feedback voltage is brought down to less than 300 mV, but greater than 150 mV, by a short circuit, the synchronous rectifier is turned off. This provides more voltage across the inductor to help maintain the required volt-second balance. If a "harder" short brings the feedback voltage to below 150 mV, the current limit and switching frequency are both reduced to about ½ of the nominal values. In addition, when the current limit is tripped, the device stops switching for about 85 µs. At the end of the time-out, switching resumes and the cycle repeats until the short is removed.

The effect of both overload and short circuit protection can be seen in [Figure 9](#). This graph demonstrates that the device will supply slightly more than 2 A to the load when in overload and much less current during fold-back mode. This is typical behavior for any regulator with this type of current limit protection.

Feature Description (continued)

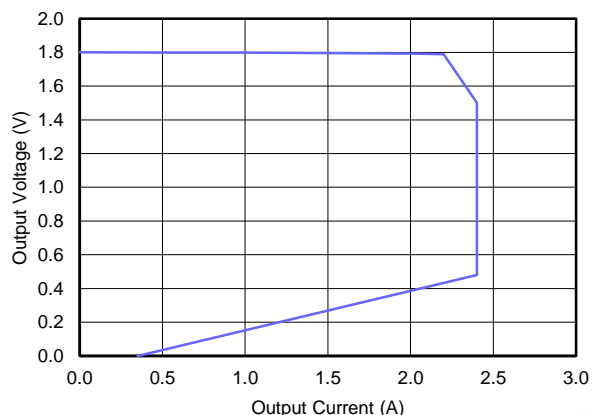

Figure 9. Typical Current Limit Profile
 $V_{IN} = 5\text{ V}$, $V_{OUT} = 1.8\text{ V}$

8.3.4 Start-Up

Start-up and shutdown of the LMZ20502 is controlled by the EN input. The characteristics of this input are found in the [Electrical Characteristics](#) table. A valid input voltage must be present on VIN before the enable control is asserted. The maximum voltage on the EN pin is 5.5 V or V_{IN} , whichever is smaller. Do not allow this input to float.

The LMZ20502 features a current limit based soft-start, that prevents large inrush currents and output overshoots as the regulator is starting up. The peak inductor current is stepped-up in a staircase fashion during the soft start period. A typical start-up event is shown in [Figure 10](#):

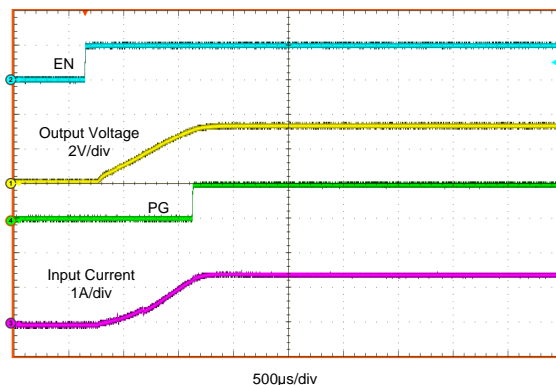

Figure 10. Typical Start-Up Waveforms, $V_{IN} = 5\text{ V}$, $V_{OUT} = 3.3\text{ V}$, $I_{OUT} = 1\text{ A}$

8.3.5 Drop-Out Behavior

When the input voltage is close to the output voltage the regulator will operate at very large duty cycles. Normal time delays of the internal circuits prevents the attainment of controlled duty cycles near 100%. In this condition the LMZ20502 will skip switching cycles in order to maintain regulation with the highest possible input-to-output ratio. Some increase in output voltage ripple may appear as the regulator skips cycles. As the input voltage gets closer to the output voltage, the regulator will eventually reach 100% duty cycle, with the high side switch turned on. The output will then follow the input voltage minus the drop across the high side switch and inductor resistance. [Figure 11](#) and [Figure 12](#) show typical drop-out behavior for output voltages of 2.5 V and 3.3 V.

Feature Description (continued)

Since the internal gate drive levels of the LMZ20502 are dependent on input voltage, the R_{dson} of the power FETs will increase at low input voltages. This will result in degraded efficiency at output currents of greater than 1 A and input voltages below about 2.9 V. Also, combinations of low input voltage and high output voltage increases the effective switch duty cycle which may result in increased output voltage ripple.

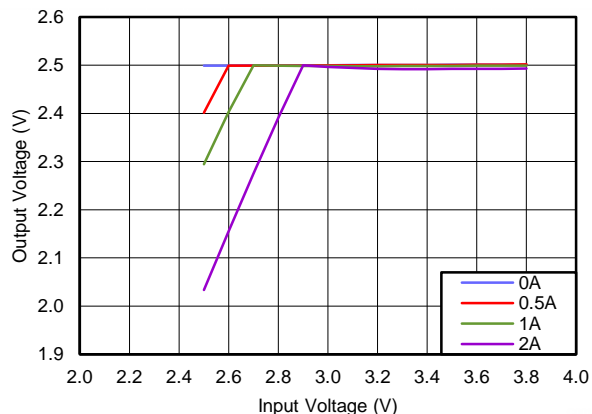

Figure 11. Typical Drop-Out Behavior, $V_{\text{OUT}} = 2.5 \text{ V}$

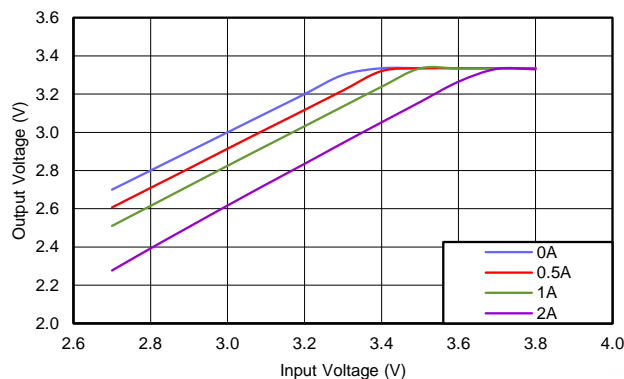

Figure 12. Typical Drop-Out Behavior, $V_{\text{OUT}} = 3.3 \text{ V}$

8.3.6 Power Good Flag Function

The operation of the power good flag function is described in the diagram shown in [Figure 13](#).

Feature Description (continued)

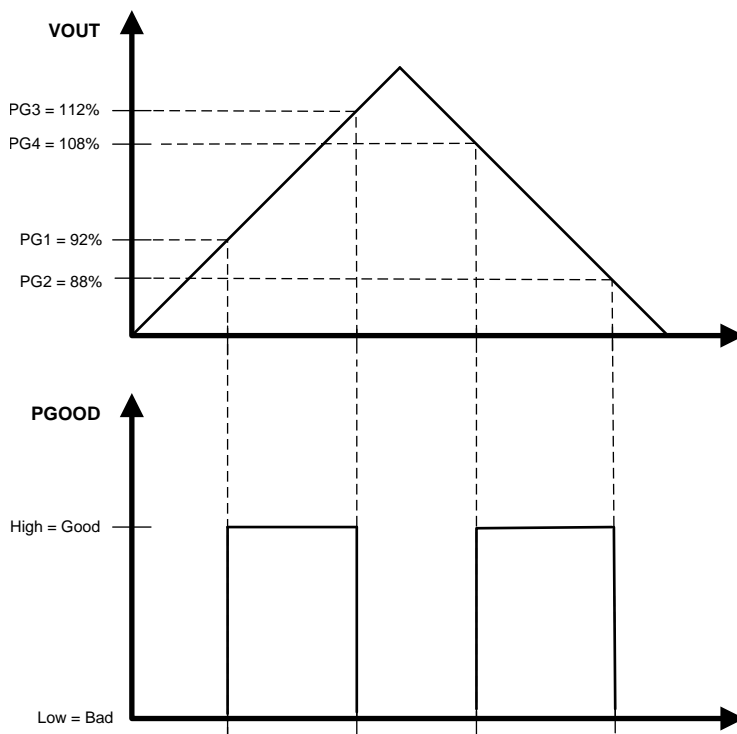

Figure 13. Typical Power Good Flag Operation

This output consists of an open drain NMOS with an R_{dson} of about 70 Ω . When used, the power good flag should be connected to a logic supply through a pull-up resistor. It can also be pulled-up to either V_{IN} or V_{OUT} , through an appropriate resistor, as desired. If this function is not needed, the PG output should be left floating. The current through this flag pin should be limited to less than 4 mA. A pull-up resistor of ≥ 1.5 k Ω will satisfy this requirement. When the EN input is pulled low, the PG flag output will also be forced low, assuming a valid input voltage is present at the VIN pin.

8.3.7 Thermal Shutdown

The LMZ20502 incorporates a thermal shutdown feature to protect the device from excessive die temperatures. The device will stop switching when the internal die temperature reaches about 159°C. Switching will resume when the die temperature drops to about 144°C.

8.4 Device Functional Modes

Please refer to Table 1 and the following paragraphs for a detailed description of the functional modes of the LMZ20502. These modes are controlled by the MODE input as shown in Table 1. The maximum voltage on the MODE pin is 5.5 V or V_{IN} , whichever is smaller. This input must not be allowed to float.

Table 1. Mode Selection

MODE PIN VOLTAGE	OPERATION
> 1.2 V	Forced PWM: The regulator operates in constant frequency, PWM mode for all loads from no-load to full load; no diode emulation is used.
< 0.4 V	AUTO Mode: The regulator operates in constant frequency mode for loads greater than the mode change threshold. For loads less than the mode change threshold, the regulator operates in PFM with diode emulation.

8.4.1 PWM Operation

In forced PWM mode, the converter operates as a constant frequency voltage mode regulator with input voltage feed-forward. This provides excellent line and load regulation and low output voltage ripple. This operation is maintained, even at no-load, by allowing the inductor current to reverse its normal direction. While in PWM mode, the output voltage is regulated by switching at a constant frequency and modulating the duty cycle to control the power to the load. This mode trades off reduced light load efficiency for low output voltage ripple and constant switching frequency. In this mode, a negative current limit of about 750mA is imposed to prevent damage to the regulator power FETs.

8.4.2 PFM Operation

When in AUTO mode, and at light loads, the device enters PFM. The regulator estimates the load current by measuring both the high side and low side switch currents. This estimate is only approximate, and the exact load current threshold, to trigger PFM, can vary greatly with input and output voltage. The [Application Curves](#) show mode change thresholds for several typical operating points. When the regulator detects this threshold, the reference voltage is increased by approximately 10 mV. This causes the output voltage to rise to meet the new regulation point. When this point is reached, the converter stops switching and much of the internal circuitry is shut off, while the reference is returned to the PWM value. This saves supply current while the output voltage naturally starts to fall under the influence of the load current. When the output voltage reaches the PWM regulation point, switching is again started and the reference voltage is again increased by about 10 mV; thus starting the next cycle. Typical waveforms are shown in [Figure 14](#):

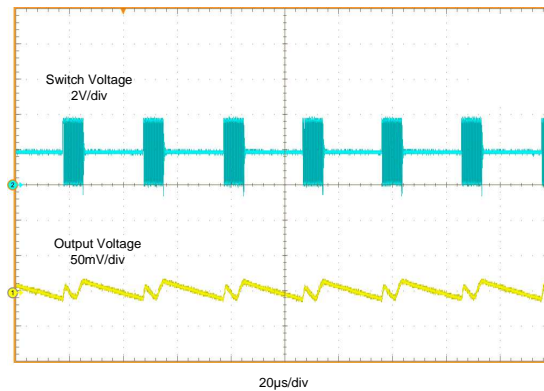

Figure 14. Typical PFM Mode Waveforms: $V_{IN} = 3.6\text{ V}$, $V_{OUT} = 1.8\text{ V}$, $I_{OUT} = 10\text{ mA}$

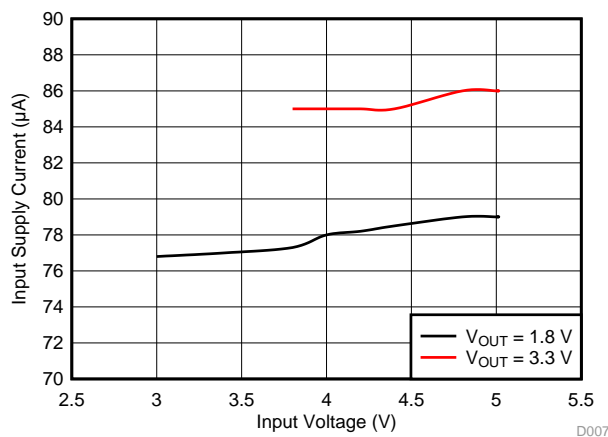

Figure 15. Typical No Load Input Supply Current

The actual output voltage ripple will depend on the feedback divider ratio and on the delay in the PFM comparator. The frequency of the PFM "bursts" will depend on the input voltage, output voltage, load and output capacitor. Within each "burst" the device switches at 3 MHz (typ.). If the load current increases above the threshold, normal PWM operation is resumed. This mode provides high light load efficiency by reducing the amount of supply current required to regulate the output at small load currents. This mode trades off very good light load efficiency for larger output voltage ripple and variable switching frequency. An example of the typical input supply current, while regulating with no load, is shown in [Figure 15](#).

Because of normal part-to-part variation, the LMZ20502 may not switch into PFM mode at high input voltages. This may be seen with output voltages of about 1.2 V and below, at input voltages of about 4.2 V and above.

9 Application and Implementation

NOTE

Information in the following applications sections is not part of the TI component specification, and TI does not warrant its accuracy or completeness. TI's customers are responsible for determining suitability of components for their purposes. Customers should validate and test their design implementation to confirm system functionality.

9.1 Application Information

The LMZ20502 is a step down DC-to-DC regulator. It is typically used to convert a higher DC voltage to a lower DC voltage with a maximum output current of 2 A. The following design procedure can be used to select components for the LMZ20502. Alternately, the WEBENCH design tool may be used to generate a complete design. WEBENCH utilizes an iterative design procedure and has access to a comprehensive database of components. This allows the tool to create an optimized design and allows the user to experiment with various design options.

9.2 Typical Application

Figure 16 shows the minimum required application circuit, set up for a 1.8 V output. Figure 17 shows a full featured application circuit. Please refer to Figure 16 and Figure 17 during the following design procedures.

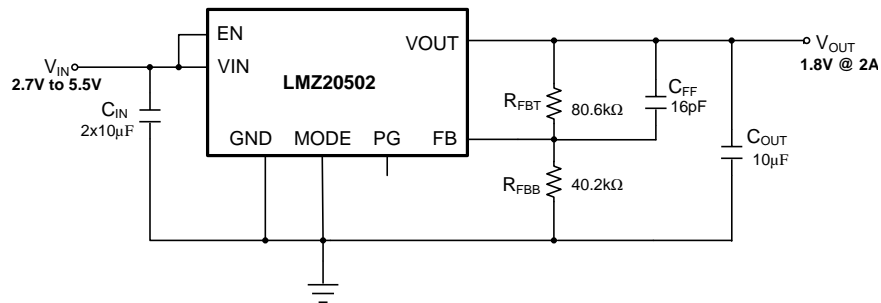

Figure 16. LMZ20502 Typical Application
 $V_{OUT} = 1.8\text{ V}$

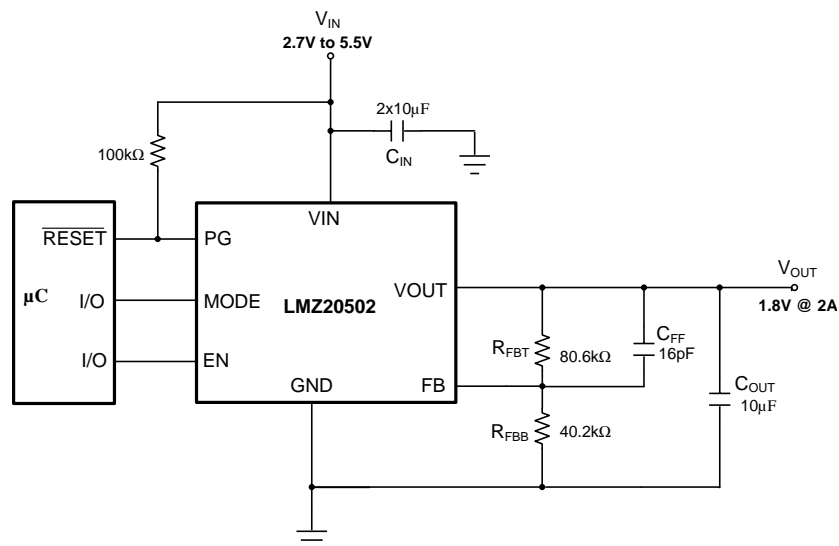

Figure 17. LMZ20502 Full Featured Application

Typical Application (continued)

9.2.1 Detailed Design Procedure

Please refer to [Table 2](#) while following the detailed design procedure. This procedure applies to both [Figure 16](#) and to [Figure 17](#). Also, the [Application Curves](#) apply to both schematics.

Table 2. Recommended Component Values⁽¹⁾

V _{OUT} (V)	R _{FBB} (kΩ)	R _{FBT} (kΩ)	C _{OUT} (μF)	EFFECTIVE C _{OUT} (μF) ⁽²⁾	C _{FF} (pF)	C _{IN} (μF)	EFFECTIVE C _{IN} (μF) ⁽²⁾
0.8	121	40.2	2 x 10	18 μF	39	2 x 10	14
1.2	30.1	30.1	10	8.8 μF	20	2 x 10	14
1.8	40.2	80.6	10	8.4 μF	16	2 x 10	14
2.5	47.5	150	10	7.8 μF	12	2 x 10	14
3.3	53.2	237	10	7.1 μF	82	2 x 10	14
3.6	53.2	267	10	6.8 μF	82	2 x 10	14

(1) C_{IN} = C_{OUT} = 10 μF, 16 V, 0805, X7R, Samsung CL21B106K0QNNNE. C_{OUT} measured at V_{OUT}; C_{IN} measured at 3.3 V.

(2) The effective value takes into account the capacitor voltage coefficient.

9.2.1.1 Setting The Output Voltage

The LMZ20502 regulates its feedback voltage to 0.6 V (typ). A feedback divider, shown in [Figure 16](#), is used to set the desired output voltage. [Equation 1](#) can be used to select R_{FBB}.

$$R_{FBB} = \frac{0.6}{(V_{OUT} - 0.6)} \cdot R_{FBT} \quad (1)$$

For best results, R_{FBT} should be chosen between 30 kΩ and 300 kΩ. See [Table 2](#) for recommended values for typical output voltages.

9.2.1.2 Output and Feed-Forward Capacitors

The LMZ20502 is designed to work with low ESR ceramic capacitors. The **effective** value of these capacitors is defined as the actual capacitance under voltage bias and temperature. All ceramic capacitors have large voltage coefficients, in addition to normal tolerances and temperature coefficients. Under D.C. bias, the capacitance value drops considerably. Larger case sizes and/or higher voltage capacitors are better in this regard. To help mitigate these effects, multiple small capacitors can be used in parallel to bring the minimum **effective** capacitance up to the desired value. This can also ease the RMS current requirements on a single capacitor. Typically, 10 V, X5R, 0805 capacitors are adequate for the output, while 16-V caps may be used on the input. Some recommended component values are provided in [Table 2](#). Also, shown are the measured values of **effective** input and output capacitance for the given capacitor. If smaller values of output capacitance are used, C_{FF} must be adjusted to give good phase margin. In any case, load transient response will be compromised with lower values of output capacitance. Values much lower than those found in [Table 2](#) should be avoided.

In practice, the output capacitor and C_{FF}, are adjusted for the best transient response and highest loop phase margin. Load transient testing and Bode plots are the best way to validate any given design. Application report [SLVA289](#) should prove helpful when optimizing the feed-forward capacitor. Also, [SNVA364](#) details a simple method of creating a Bode plot with basic laboratory equipment. The values of C_{FF} found in [Table 2](#) provide a good starting point.

A careful study of the temperature and bias voltage variation of any candidate ceramic capacitor should be made in order to ensure that the minimum values of **effective** capacitance are provided. The best way to obtain an optimum design is to use the Texas Instruments WEBENCH tool.

The maximum value of total output capacitance should be limited to between 100 μF and 200 μF. Large values of output capacitance can prevent the regulator from starting-up correctly and adversely affect the loop stability. If values in the range given above, or larger, are to be used, then a careful study of start-up at full load and loop stability must be performed.

9.2.1.3 Input Capacitors

The ceramic input capacitors provide a low impedance source to the regulator in addition to supplying ripple current and isolating switching noise from other circuits. An **effective** value of at least 14 μF is normally sufficient for the input capacitor. If the main input capacitor(s) can not be placed close to the module, then a small 10 nF to 100 nF capacitor should be placed directly at the module, across the supply and ground pins.

Many times it is desirable to use an electrolytic capacitor on the input, in parallel with the ceramics. This is especially true if long leads/traces are used to connect the input supply to the regulator. The moderate ESR of this capacitor can help damp any ringing on the input supply caused by long power leads. This method can also help to reduce voltage spikes that may exceed the maximum input voltage rating of the LMZ20502. The use of this additional capacitor will also help with voltage dips caused by input supplies with unusually high impedance.

Most of the switching current passes through the input ceramic capacitor(s). The approximate RMS value of this current can be calculated with [Equation 2](#) and should be checked against the manufactures maximum ratings.

$$I_{\text{RMS}} \approx \frac{I_{\text{OUT}}}{2} \quad (2)$$

9.2.1.4 Maximum Ambient Temperature

As with any power conversion device, the LMZ20502 will dissipate internal power while operating. The effect of this power dissipation is to raise the internal temperature of the converter, above ambient. The internal die temperature is a function of the ambient temperature, the power loss and the effective thermal resistance $R_{\theta\text{JA}}$ of the device and PCB combination. The maximum internal die temperature for the LMZ20502 is 125°C, thus establishing a limit on the maximum device power dissipation and therefore load current at high ambient temperatures. [Equation 3](#) shows the relationships between the important parameters.

$$I_{\text{OUT}} = \frac{(T_{\text{J}} - T_{\text{A}})}{R_{\theta\text{JA}}} \cdot \frac{\eta}{(1 - \eta)} \cdot \frac{1}{V_{\text{OUT}}} \quad (3)$$

It is easy to see that larger ambient temperatures and larger values of $R_{\theta\text{JA}}$ will reduce the maximum available output current. As stated in [SPRA953](#), the values given in the [Thermal Information](#) table are not valid for design purposes and must not be used to estimate the thermal performance of the application. The values reported in that table were measured under a specific set of conditions that never obtain in an actual application. The effective $R_{\theta\text{JA}}$ is a critical parameter and depends on many factors such as power dissipation, air temperature, PCB area, copper heatsink area, air flow, and adjacent component placement. The resources found in [Table 3](#) can be used as a guide to estimate the $R_{\theta\text{JA}}$ for a given application environment. A typical example of $R_{\theta\text{JA}}$ versus copper board area is shown in [Figure 18](#). The copper area in this graph is that for each layer; the inner layers are 1 oz. (35 μm). An $R_{\theta\text{JA}}$ of 44°C/W is the approximate value for the LMZ20502 evaluation board. The efficiency found in the equation, η , should be taken at the elevated ambient temperature. For the LMZ20502 the efficiency is about two to three percent lower at high temperatures. Therefore, a slightly lower value than the typical efficiency can be used in the calculation. In this way [Equation 3](#) can be used to estimate the maximum output current for a given ambient, or to estimate the maximum ambient for a given load current.

A typical curve of maximum load current vs. ambient temperature is shown in [Figure 19](#). This graph assumes a $R_{\theta\text{JA}}$ of 44°C/W and an input voltage of 5 V.

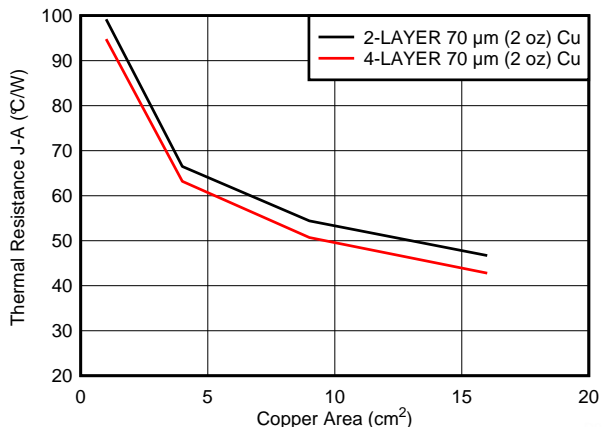

Figure 18. $R_{\theta JA}$ versus Copper Board Area

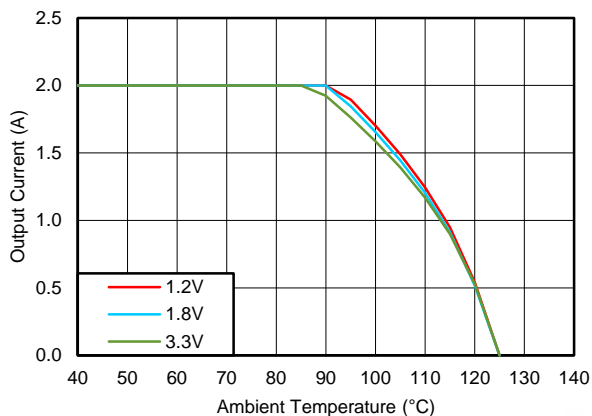

Figure 19. Maximum Output Current Vs. Ambient Temperature, $R_{\theta JA} = 44^{\circ}\text{C/W}$, $V_{IN} = 5\text{ V}$

9.2.1.5 Options

The circuit in Figure 17 highlights the use of the features of the LMZ20502. The PG output is open drain, and requires a pull-up resistor to a logic supply that is commensurate with the system logic voltage levels. If a reset function is not needed, the PG pin should be left open. The EN and MODE inputs are digital inputs, requiring only simple logic levels for proper operation. If the system does not need to control these features, the inputs should be connected to either V_{IN} or GND, as appropriate. Please see [Feature Description](#) for details.

9.2.2 Application Curves

The following specifications apply to the circuit found in [Figure 16](#) or [Figure 17](#) with the appropriate modifications from [Table 2](#). **These parameters are not tested and represent typical performance only.** Unless otherwise stated the following conditions apply: $T_A = 25^\circ\text{C}$.

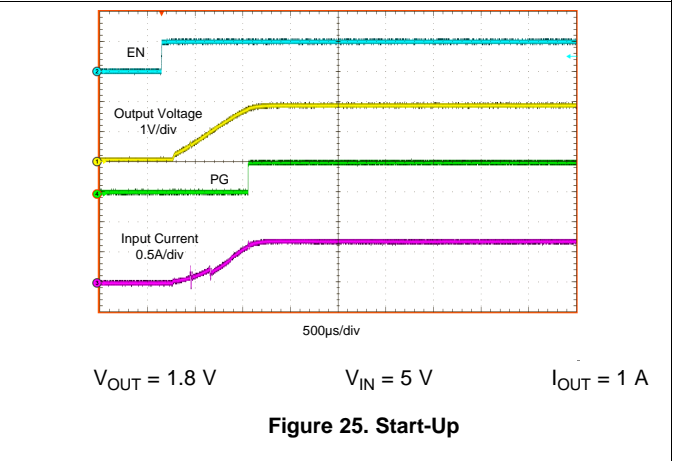
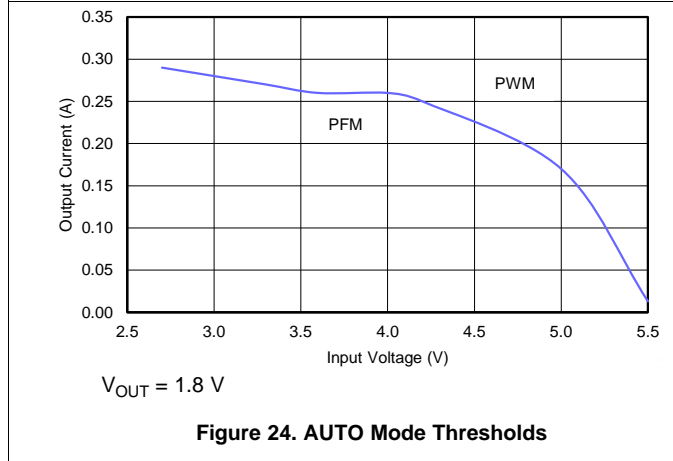
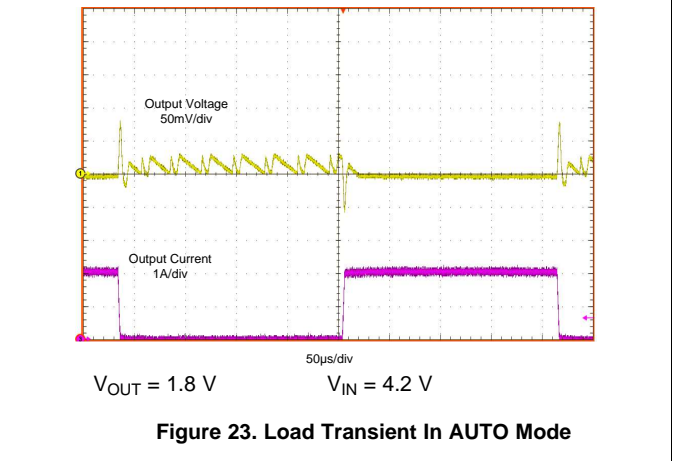
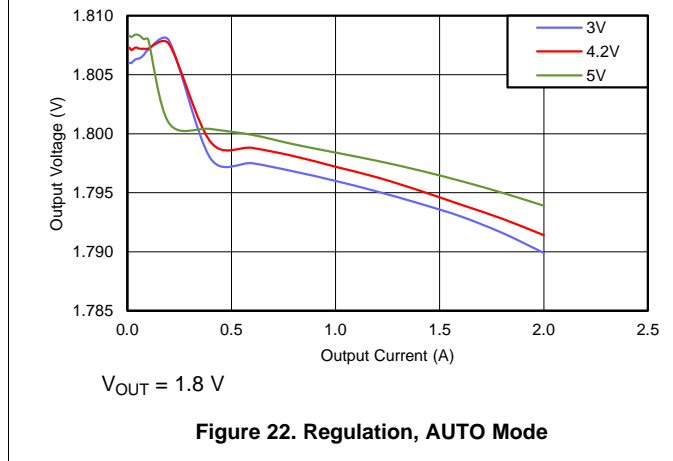
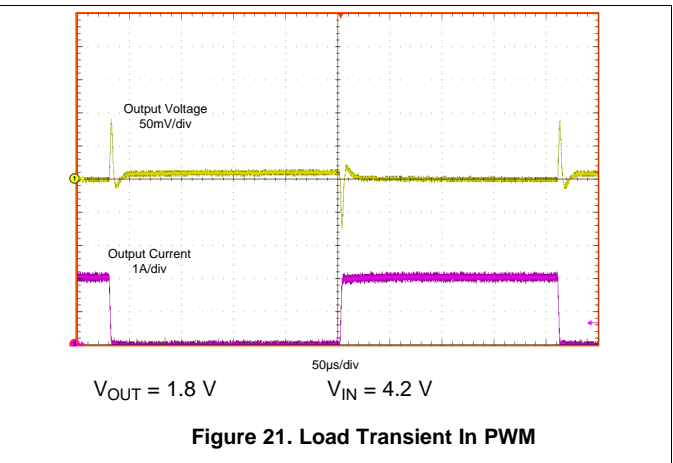
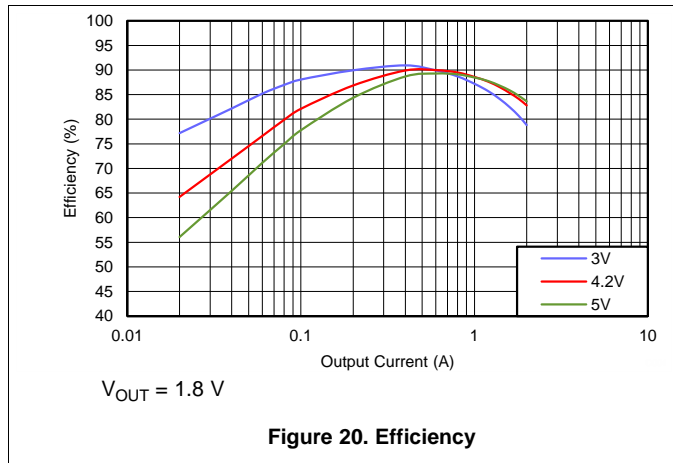

The following specifications apply to the circuit found in [Figure 16](#) or [Figure 17](#) with the appropriate modifications from [Table 2](#). **These parameters are not tested and represent typical performance only.** Unless otherwise stated the following conditions apply: $T_A = 25^\circ\text{C}$.

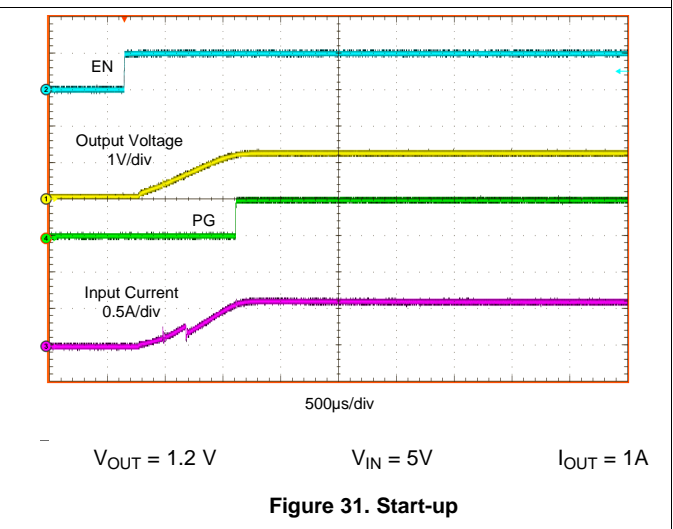
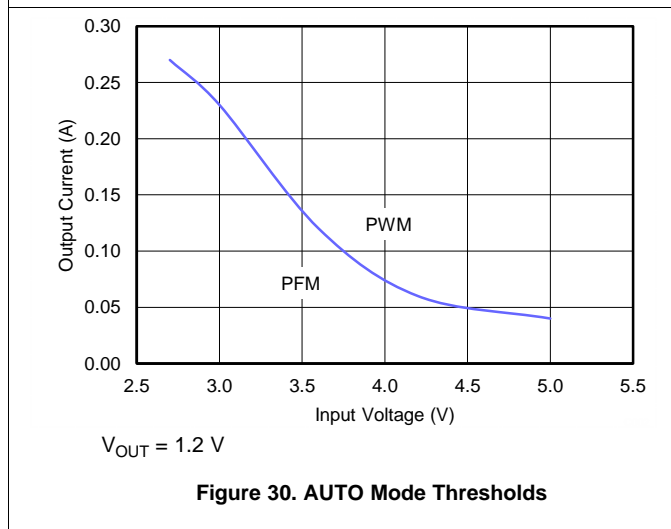
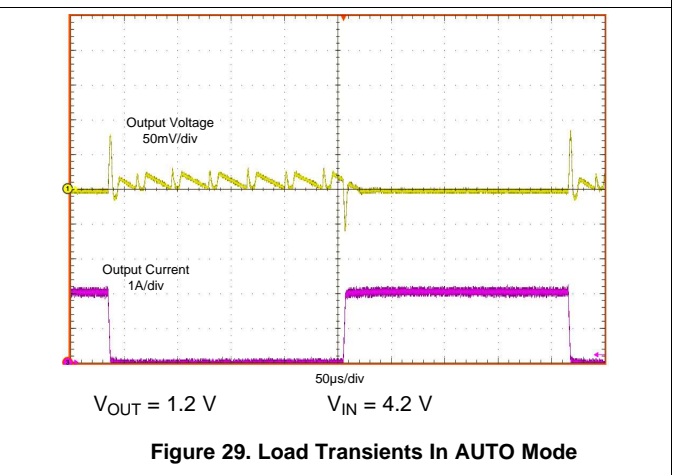
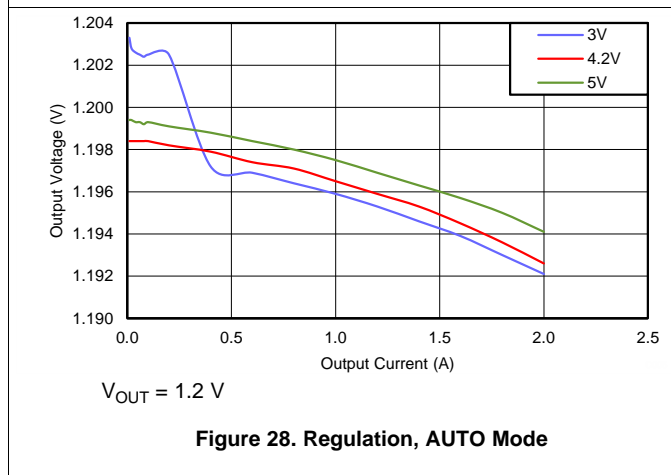
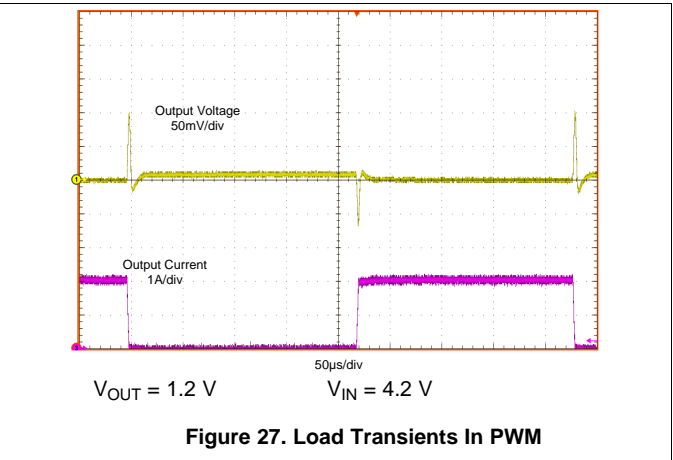
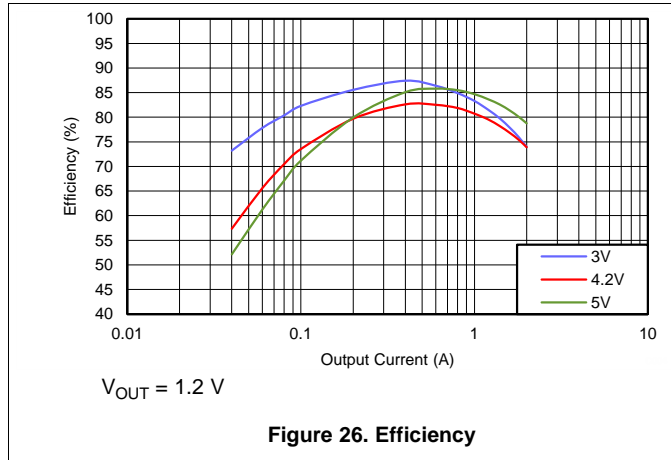

LMZ20502

SNVS852C – JUNE 2012 – REVISED APRIL 2015

www.ti.com

The following specifications apply to the circuit found in [Figure 16](#) or [Figure 17](#) with the appropriate modifications from [Table 2](#). **These parameters are not tested and represent typical performance only.** Unless otherwise stated the following conditions apply: $T_A = 25^\circ\text{C}$.

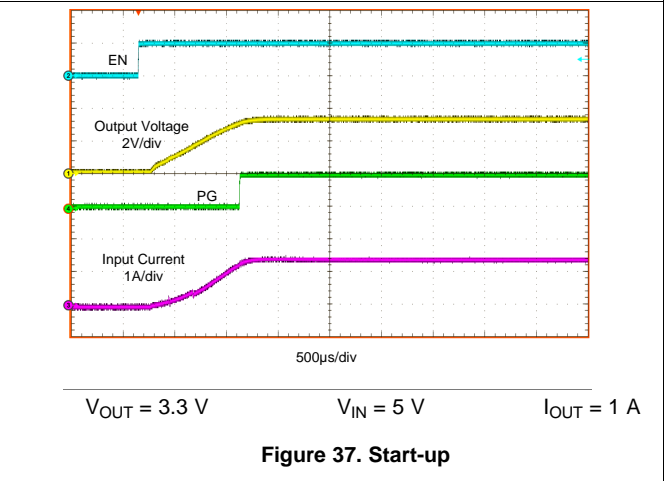
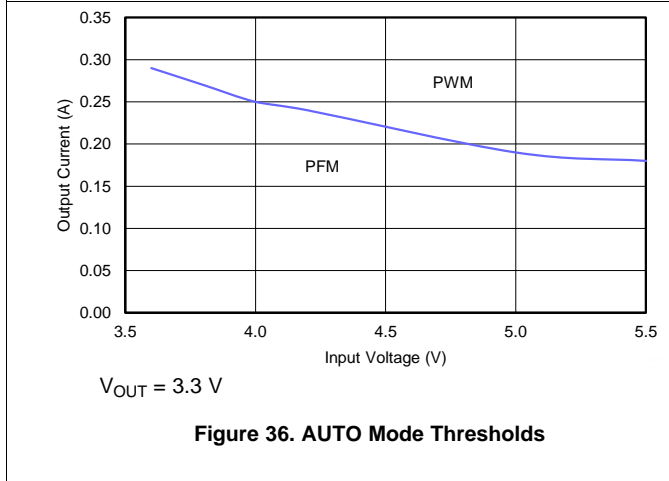
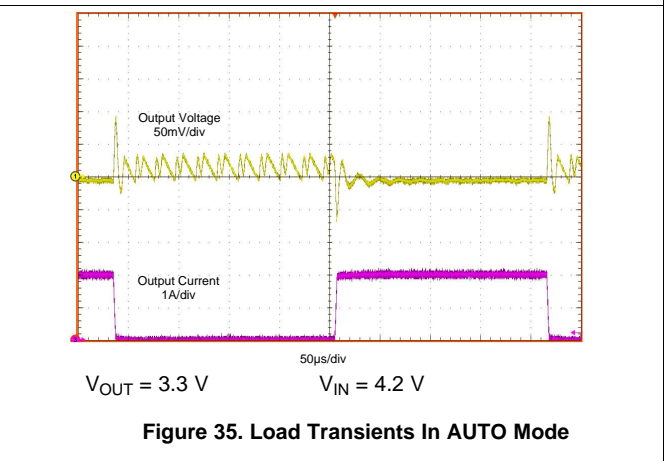
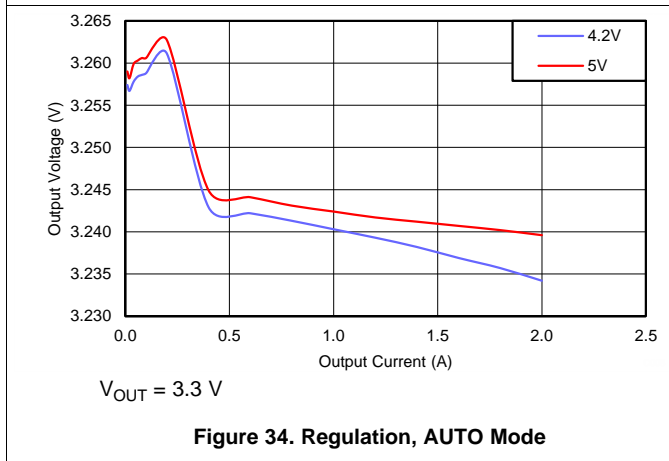
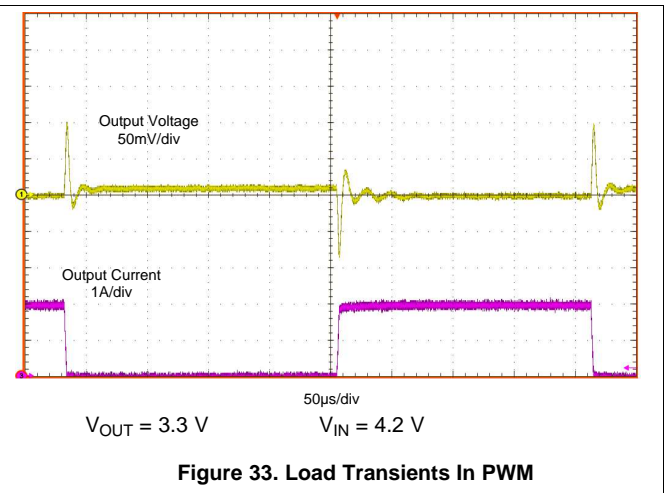
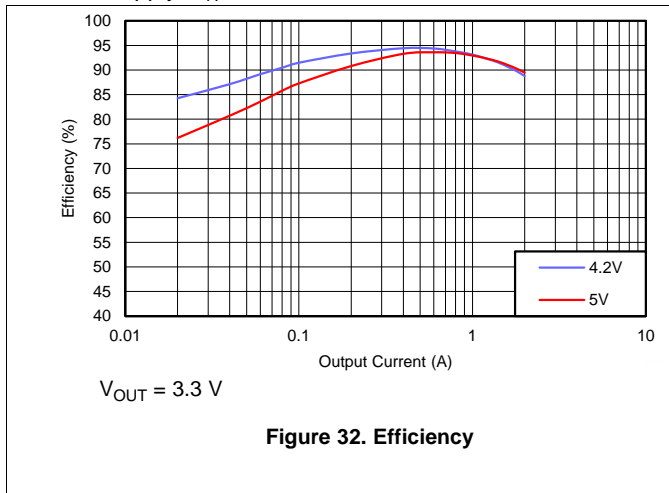

9.3 Do's and Don'ts

- **Don't:** Exceed the [Absolute Maximum Ratings](#).
- **Don't:** Exceed the [ESD Ratings](#).
- **Don't:** Exceed the [Recommended Operating Conditions](#).
- **Don't:** Allow the EN or MODE input to float.
- **Don't:** Allow the voltage on the EN or MODE input to exceed the voltage on the VIN pin.
- **Don't:** Allow the output voltage to exceed the input voltage.
- **Don't:** Use the thermal data given in the [Thermal Information](#) table to design your application.
- **Do:** Follow all of the guidelines and/or suggestions found in this data sheet, before committing your design to production. TI Application Engineers are ready to help critique your design and PCB layout to help make your project a success.
- **Do:** Refer to the helpful documents found in [Table 3](#) and [Table 4](#).

10 Power Supply Recommendations

The characteristics of the input supply must be compatible with the [Absolute Maximum Ratings](#) and [Recommended Operating Conditions](#) found in this data sheet. In addition, the input supply must be capable of delivering the required input current to the loaded regulator. The average input current can be estimated with [Equation 4](#)

$$I_{IN} = \frac{V_{OUT} \cdot I_{OUT}}{V_{IN} \cdot \eta} \quad (4)$$

If the regulator is connected to the input supply through long wires or PCB traces, special care is required to achieve good performance. The parasitic inductance and resistance of the input cables can have an adverse effect on the operation of the regulator. The parasitic inductance, in combination with the low ESR ceramic input capacitors, can form an under-damped resonant circuit. This circuit may cause over-voltage transients at the VIN pin, each time the input supply is cycled on and off. The parasitic resistance will cause the voltage at the VIN pin to dip when the load on the regulator is switched on, or exhibits a transient. If the regulator is operating close to the minimum input voltage, this dip may cause the device to shutdown and/or reset. The best way to solve these kinds of issues is to reduce the distance from the input supply to the regulator and/or use an aluminum or tantalum input capacitor in parallel with the ceramics. The moderate ESR of these types of capacitors will help to damp the input resonant circuit and reduce any voltage overshoots. A value in the range of 20 μ F to 100 μ F is usually sufficient to provide input damping and help to hold the input voltage steady during large load transients.

Sometimes, for other system considerations, an input filter is used in front of the regulator module. This can lead to instability, as well as some of the effects mentioned above, unless it is designed carefully. The following user guide provides helpful suggestions when designing an input filter for any switching regulator: [SNVA489](#).

In some cases a Transient Voltage Suppressor (TVS) is used on the input of regulators. One class of this device has a "snap-back" V-I characteristic (thyristor type). The use of a device with this type of characteristic is not recommended. When the TVS "fires", the clamping voltage drops to a very low value. If this holding voltage is less than the output voltage of the regulator, the output capacitors will be discharged through the regulator back to the input. This uncontrolled current flow could damage the regulator.

11 Layout

11.1 Layout Guidelines

The PCB layout of any DC-DC converter is critical to the optimal performance of the design. Bad PCB layout can disrupt the operation of an otherwise good schematic design. Even if the converter regulates correctly, bad PCB layout can mean the difference between a robust design and one that cannot be mass produced. Furthermore, the EMI performance of the regulator is dependent on the PCB layout, to a great extent. In a buck converter, the most critical PCB feature is the loop formed by the input capacitor and the module ground, as shown in Figure 38. This loop carries fast transient currents that can cause large transient voltages when reacting with the trace inductance. These unwanted transient voltages will disrupt the proper operation of the converter. Because of this, the traces in this loop should be wide and short, and the loop area as small as possible to reduce the parasitic inductance. Figure 39 shows a recommended layout for the critical components of the LMZ20502; the top side metal is shown in red. This PCB layout is a good guide for any specific application. The following important guidelines should also be followed:

1. **Place the input capacitor CIN as close as possible to the VIN and GND terminals.** VIN (pin 8) and GND (pin 6) are on the same side of the module, simplifying the input capacitor placement.
2. **Place the feedback divider as close as possible to the FB pin on the module.** The divider and C_{FF} should be close to the module, while the length of the trace from VOUT to the divider can be somewhat longer. However, this latter trace should not be routed near any noise sources that can capacitively couple to the FB input.
3. **Connect the EP pad to the GND plane.** This pad acts as a heat-sink connection and a ground connection for the module. It must be solidly connected to a ground plane. The integrity of this connection has a direct bearing on the effective $R_{\theta JA}$.
4. **Provide enough PCB area for proper heat-sinking.** As stated in the *Maximum Ambient Temperature* section, enough copper area must be used to provide a low $R_{\theta JA}$, commensurate with the maximum load current and ambient temperature. The top and bottom PCB layers should be made with two ounce copper; and no less than one ounce.
5. **The resources in Table 4 provide additional important guidelines**

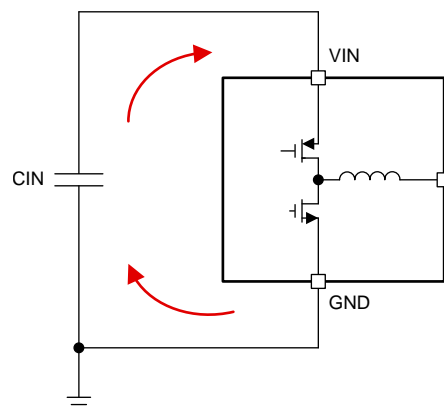

Figure 38. Current Loops With Fast Transient Currents

11.2 Layout Example

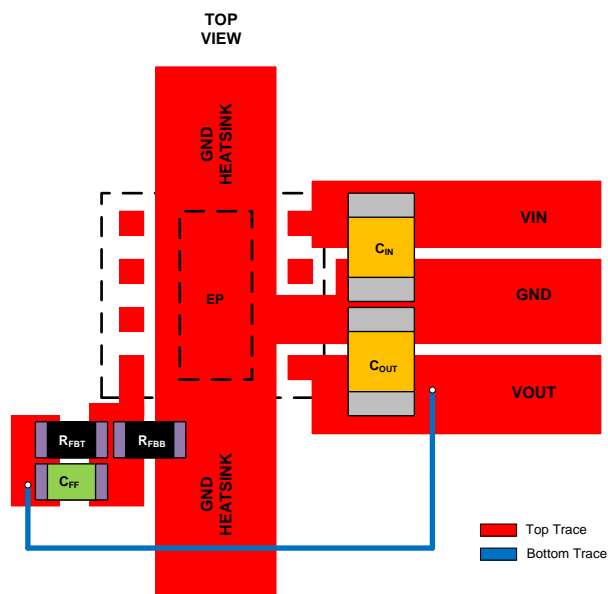

Figure 39. Example PCB Layout

11.3 Soldering Information

Proper operation of the LMZ20502 requires that it be correctly soldered to the PCB. This is especially true regarding the EP. This pad acts as a quiet ground reference for the device and a heatsink connection. Use the following recommendations when utilizing machine placement of the device:

- Dimension of area for pick-up: 2 mm x 2.5 mm.
- Use a nozzle size of less than 1.3 mm in diameter, so that the head does not touch the outer area of the package.
- Use a soft tip pick-and-place head.
- Add 0.05 mm to the component thickness so that the device will be released 0.05 mm into the solder paste without putting pressure or splashing the solder paste.
- Slow the pick arm when picking the part from the tape and reel carrier and when depositing the device on the board.
- If the machine releases the component by force, use the minimum force and no more than 3 N.
- For PCBs with surface mount components on both sides, it is suggested to put the LMZ20502 on the top side. In case the application requires bottom side placement, a re-flow fixture may be required to protect the module during the second reflow.

In addition, please follow the important guidelines found in: [SNOA401](#). The curves in [Figure 40](#) and [Figure 41](#) show typical soldering temperature profiles.

Soldering Information (continued)

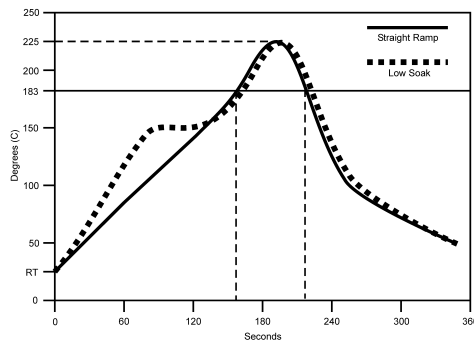

Figure 40. Typical Re-flow Profile Eutectic (63sn/37pb) Solder Paste

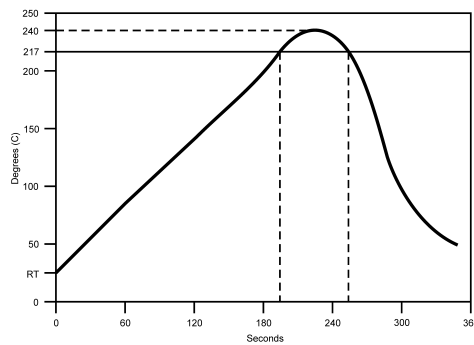

Figure 41. Typical Re-flow Profile Lead-Free (Sca305 Or Sac405) Solder Paste

12 Device and Documentation Support

12.1 Device Support

12.1.1 Third-Party Products Disclaimer

TI'S PUBLICATION OF INFORMATION REGARDING THIRD-PARTY PRODUCTS OR SERVICES DOES NOT CONSTITUTE AN ENDORSEMENT REGARDING THE SUITABILITY OF SUCH PRODUCTS OR SERVICES OR A WARRANTY, REPRESENTATION OR ENDORSEMENT OF SUCH PRODUCTS OR SERVICES, EITHER ALONE OR IN COMBINATION WITH ANY TI PRODUCT OR SERVICE.

12.1.2 Related Links

For more information about Texas Instruments Simple Switcher product line, please visit our Simple Switcher page: [Simple Switcher](#).

Table 3. Resources For Estimating $R_{\theta JA}$

TITLE	LINK
AN-2020 <i>Thermal Design By Insight, Not Hindsight</i>	SNVA419
AN-2026 <i>The Effect of PCB Design on the Thermal Performance of SIMPLE SWITCHER Power Modules</i>	SNVA424
AN-1520 <i>A Guide to Board Layout for Best Thermal Resistance for Exposed Packages</i>	SNVA183
AN-1187 <i>Leadless Lead-frame Package (LLP)</i>	SNOA401
SPRA953B <i>Semiconductor and IC Package Thermal Metrics</i>	SPRA953

Table 4. PCB Layout Resources

TITLE	LINK
AN-1149 <i>Layout Guidelines for Switching Power Supplies</i>	SNVA021
AN-1229 <i>SIMPLE SWITCHER PCB Layout Guidelines</i>	SNVA054
<i>Constructing Your Power Supply- Layout Considerations</i>	SLUP230

12.2 Trademarks

WebTherm is a trademark of Texas Instruments.

SIMPLE SWITCHER, WEBENCH are registered trademarks of Texas Instruments.

All other trademarks are the property of their respective owners.

12.3 Electrostatic Discharge Caution



These devices have limited built-in ESD protection. The leads should be shorted together or the device placed in conductive foam during storage or handling to prevent electrostatic damage to the MOS gates.

12.4 Glossary

[SLYZ022](#) — *TI Glossary*.

This glossary lists and explains terms, acronyms, and definitions.

13 Mechanical, Packaging, and Orderable Information

The following pages include mechanical, packaging, and orderable information. This information is the most current data available for the designated devices. This data is subject to change without notice and revision of this document. For browser-based versions of this data sheet, refer to the left-hand navigation.

EXAMPLE BOARD LAYOUT

SIL0008F

MicroSiP™ - 1.75 mm max height

MICRO SYSTEM IN PACKAGE

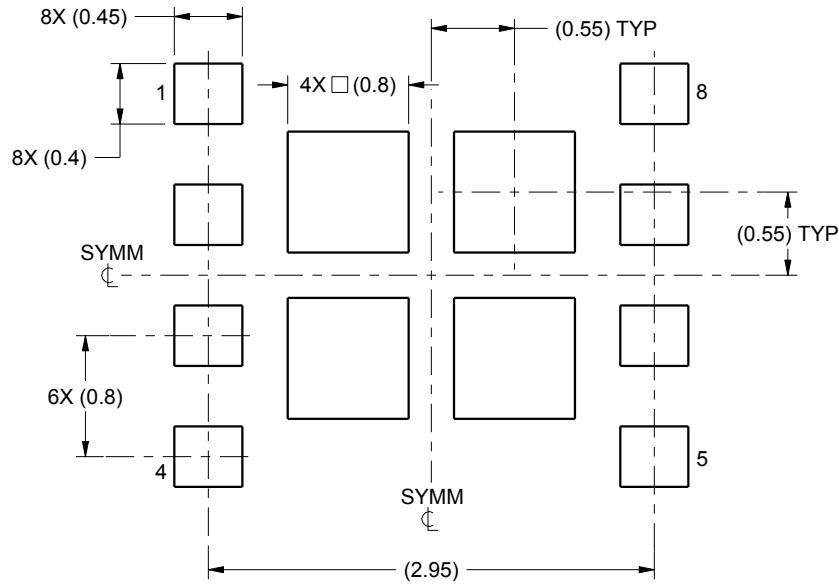

LAND PATTERN EXAMPLE
1:1 RATIO WITH PACKAGE SOLDER PADS
SCALE:20X

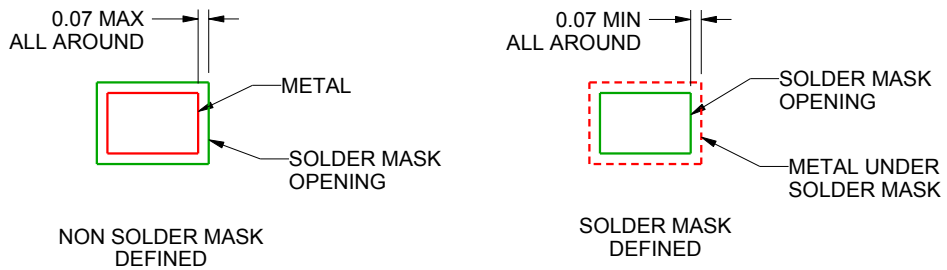

SOLDER MASK DETAILS
NOT TO SCALE

4221559/B 11/2014

NOTES: (continued)

4. This package is designed to be soldered to a thermal pad on the board. For more information, see Texas Instruments literature number SLUA271 (www.ti.com/lit/slua271).

EXAMPLE STENCIL DESIGN

SIL0008F

MicroSiP™ - 1.75 mm max height

MICRO SYSTEM IN PACKAGE

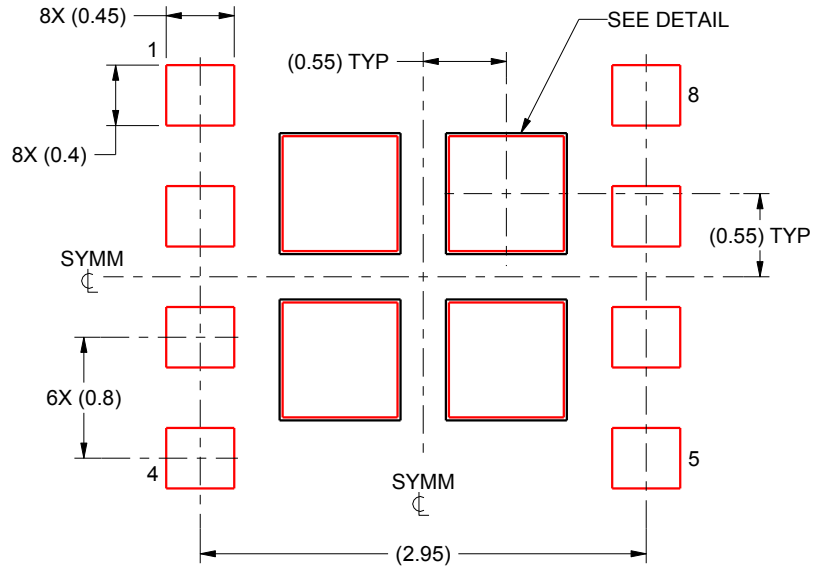

SOLDER PASTE EXAMPLE
BASED ON 0.125 mm THICK STENCIL

EXPOSED PAD
90% PRINTED SOLDER COVERAGE BY AREA
SCALE:20X

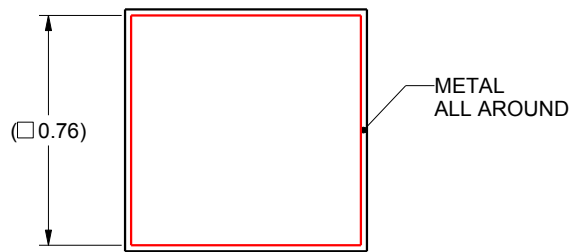

DETAIL
4 PLACES

4221559/B 11/2014

NOTES: (continued)

5. Laser cutting apertures with trapezoidal walls and rounded corners may offer better paste release. IPC-7525 may have alternate design recommendations.

13.1 Package Option Addendum

13.1.1 Packaging Information



Orderable Device	Status ⁽¹⁾	Package Type	Package Drawing	Pins	Package Qty	Eco Plan ⁽²⁾	Lead/Ball Finish	MSL Peak Temp ⁽³⁾	Op Temp (°C)	Device Marking ⁽⁴⁾⁽⁵⁾
LM20502SILR	ACTIVE	uSIP	SIL	8	3000	Green (RoHS & no Sb/Br)	Call TI	Level-3-260C-168 HR	-40 to 125	0502 7543 EC
LM20502SILT	ACTIVE	uSIP	SIL	8	250	Green (RoHS & no Sb/Br)	Call TI	Level-3-260C-168 HR	-40 to 125	0502 7543 EC

- (1) The marketing status values are defined as follows:
ACTIVE: Product device recommended for new designs.
LIFEBUY: TI has announced that the device will be discontinued, and a lifetime-buy period is in effect.
NRND: Not recommended for new designs. Device is in production to support existing customers, but TI does not recommend using this part in a new design.
PRE_PROD Unannounced device, not in production, not available for mass market, nor on the web, samples not available.
PREVIEW: Device has been announced but is not in production. Samples may or may not be available.
OBSOLETE: TI has discontinued the production of the device.
- (2) Eco Plan - The planned eco-friendly classification: Pb-Free (RoHS), Pb-Free (RoHS Exempt), or Green (RoHS & no Sb/Br) - please check <http://www.ti.com/productcontent> for the latest availability information and additional product content details.
TBD: The Pb-Free/Green conversion plan has not been defined.
Pb-Free (RoHS): TI's terms "Lead-Free" or "Pb-Free" mean semiconductor products that are compatible with the current RoHS requirements for all 6 substances, including the requirement that lead not exceed 0.1% by weight in homogeneous materials. Where designed to be soldered at high temperatures, TI Pb-Free products are suitable for use in specified lead-free processes.
Pb-Free (RoHS Exempt): This component has a RoHS exemption for either 1) lead-based flip-chip solder bumps used between the die and package, or 2) lead-based die adhesive used between the die and leadframe. The component is otherwise considered Pb-Free (RoHS compatible) as defined above.
Green (RoHS & no Sb/Br): TI defines "Green" to mean Pb-Free (RoHS compatible), and free of Bromine (Br) and Antimony (Sb) based flame retardants (Br or Sb do not exceed 0.1% by weight in homogeneous material)
- (3) MSL, Peak Temp. -- The Moisture Sensitivity Level rating according to the JEDEC industry standard classifications, and peak solder temperature.
- (4) There may be additional marking, which relates to the logo, the lot trace code information, or the environmental category on the device
- (5) Multiple Device markings will be inside parentheses. Only on Device Marking contained in parentheses and separated by a "-" will appear on a device. If a line is indented then it is a continuation of the previous line and the two combined represent the entire Device Marking for that device.

Important Information and Disclaimer: The information provided on this page represents TI's knowledge and belief as of the date that it is provided. TI bases its knowledge and belief on information provided by third parties, and makes no representation or warranty as to the accuracy of such information. Efforts are underway to better integrate information from third parties. TI has taken and continues to take reasonable steps to provide representative and accurate information but may not have conducted destructive testing or chemical analysis on incoming materials and chemicals. TI and TI suppliers consider certain information to be proprietary, and thus CAS numbers and other limited information may not be available for release.

In no event shall TI's liability arising out of such information exceed the total purchase price of the TI part(s) at issue in this document sold by TI to Customer on an annual basis.

PACKAGING INFORMATION

Orderable Device	Status (1)	Package Type	Package Drawing	Pins	Package Qty	Eco Plan (2)	Lead/Ball Finish (6)	MSL Peak Temp (3)	Op Temp (°C)	Device Marking (4/5)	Samples
LMZ20502SILR	ACTIVE	uSiP	SIL	8	3000	Green (RoHS & no Sb/Br)	Call TI	Level-3-260C-168 HR	-40 to 125	TXN5201EC EC 7543 0502 0502 7543 EC	
LMZ20502SILT	ACTIVE	uSiP	SIL	8	250	Green (RoHS & no Sb/Br)	Call TI	Level-3-260C-168 HR	-40 to 125	TXN5201EC EC 7543 0502 0502 7543 EC	

(1) The marketing status values are defined as follows:

ACTIVE: Product device recommended for new designs.

LIFEBUY: TI has announced that the device will be discontinued, and a lifetime-buy period is in effect.

NRND: Not recommended for new designs. Device is in production to support existing customers, but TI does not recommend using this part in a new design.

PREVIEW: Device has been announced but is not in production. Samples may or may not be available.

OBSOLETE: TI has discontinued the production of the device.

(2) Eco Plan - The planned eco-friendly classification: Pb-Free (RoHS), Pb-Free (RoHS Exempt), or Green (RoHS & no Sb/Br) - please check <http://www.ti.com/productcontent> for the latest availability information and additional product content details.

TBD: The Pb-Free/Green conversion plan has not been defined.

Pb-Free (RoHS): TI's terms "Lead-Free" or "Pb-Free" mean semiconductor products that are compatible with the current RoHS requirements for all 6 substances, including the requirement that lead not exceed 0.1% by weight in homogeneous materials. Where designed to be soldered at high temperatures, TI Pb-Free products are suitable for use in specified lead-free processes.

Pb-Free (RoHS Exempt): This component has a RoHS exemption for either 1) lead-based flip-chip solder bumps used between the die and package, or 2) lead-based die adhesive used between the die and leadframe. The component is otherwise considered Pb-Free (RoHS compatible) as defined above.

Green (RoHS & no Sb/Br): TI defines "Green" to mean Pb-Free (RoHS compatible), and free of Bromine (Br) and Antimony (Sb) based flame retardants (Br or Sb do not exceed 0.1% by weight in homogeneous material)

(3) MSL, Peak Temp. - The Moisture Sensitivity Level rating according to the JEDEC industry standard classifications, and peak solder temperature.

(4) There may be additional marking, which relates to the logo, the lot trace code information, or the environmental category on the device.

(5) Multiple Device Markings will be inside parentheses. Only one Device Marking contained in parentheses and separated by a "~" will appear on a device. If a line is indented then it is a continuation of the previous line and the two combined represent the entire Device Marking for that device.

(6) Lead/Ball Finish - Orderable Devices may have multiple material finish options. Finish options are separated by a vertical ruled line. Lead/Ball Finish values may wrap to two lines if the finish value exceeds the maximum column width.

Important Information and Disclaimer: The information provided on this page represents TI's knowledge and belief as of the date that it is provided. TI bases its knowledge and belief on information provided by third parties, and makes no representation or warranty as to the accuracy of such information. Efforts are underway to better integrate information from third parties. TI has taken and continues to take reasonable steps to provide representative and accurate information but may not have conducted destructive testing or chemical analysis on incoming materials and chemicals. TI and TI suppliers consider certain information to be proprietary, and thus CAS numbers and other limited information may not be available for release.

In no event shall TI's liability arising out of such information exceed the total purchase price of the TI part(s) at issue in this document sold by TI to Customer on an annual basis.

TAPE AND REEL INFORMATION



QUADRANT ASSIGNMENTS FOR PIN 1 ORIENTATION IN TAPE



*All dimensions are nominal

Device	Package Type	Package Drawing	Pins	SPQ	Reel Diameter (mm)	Reel Width W1 (mm)	A0 (mm)	B0 (mm)	K0 (mm)	P1 (mm)	W (mm)	Pin1 Quadrant
LMZ20502SILR	uSiP	SIL	8	3000	330.0	12.4	3.75	3.75	2.2	8.0	12.0	Q2

TAPE AND REEL BOX DIMENSIONS



*All dimensions are nominal

Device	Package Type	Package Drawing	Pins	SPQ	Length (mm)	Width (mm)	Height (mm)
LMZ20502SILR	uSiP	SIL	8	3000	383.0	353.0	58.0

IMPORTANT NOTICE

Texas Instruments Incorporated and its subsidiaries (TI) reserve the right to make corrections, enhancements, improvements and other changes to its semiconductor products and services per JESD46, latest issue, and to discontinue any product or service per JESD48, latest issue. Buyers should obtain the latest relevant information before placing orders and should verify that such information is current and complete. All semiconductor products (also referred to herein as "components") are sold subject to TI's terms and conditions of sale supplied at the time of order acknowledgment.

TI warrants performance of its components to the specifications applicable at the time of sale, in accordance with the warranty in TI's terms and conditions of sale of semiconductor products. Testing and other quality control techniques are used to the extent TI deems necessary to support this warranty. Except where mandated by applicable law, testing of all parameters of each component is not necessarily performed.

TI assumes no liability for applications assistance or the design of Buyers' products. Buyers are responsible for their products and applications using TI components. To minimize the risks associated with Buyers' products and applications, Buyers should provide adequate design and operating safeguards.

TI does not warrant or represent that any license, either express or implied, is granted under any patent right, copyright, mask work right, or other intellectual property right relating to any combination, machine, or process in which TI components or services are used. Information published by TI regarding third-party products or services does not constitute a license to use such products or services or a warranty or endorsement thereof. Use of such information may require a license from a third party under the patents or other intellectual property of the third party, or a license from TI under the patents or other intellectual property of TI.

Reproduction of significant portions of TI information in TI data books or data sheets is permissible only if reproduction is without alteration and is accompanied by all associated warranties, conditions, limitations, and notices. TI is not responsible or liable for such altered documentation. Information of third parties may be subject to additional restrictions.

Resale of TI components or services with statements different from or beyond the parameters stated by TI for that component or service voids all express and any implied warranties for the associated TI component or service and is an unfair and deceptive business practice. TI is not responsible or liable for any such statements.

Buyer acknowledges and agrees that it is solely responsible for compliance with all legal, regulatory and safety-related requirements concerning its products, and any use of TI components in its applications, notwithstanding any applications-related information or support that may be provided by TI. Buyer represents and agrees that it has all the necessary expertise to create and implement safeguards which anticipate dangerous consequences of failures, monitor failures and their consequences, lessen the likelihood of failures that might cause harm and take appropriate remedial actions. Buyer will fully indemnify TI and its representatives against any damages arising out of the use of any TI components in safety-critical applications.

In some cases, TI components may be promoted specifically to facilitate safety-related applications. With such components, TI's goal is to help enable customers to design and create their own end-product solutions that meet applicable functional safety standards and requirements. Nonetheless, such components are subject to these terms.

No TI components are authorized for use in FDA Class III (or similar life-critical medical equipment) unless authorized officers of the parties have executed a special agreement specifically governing such use.

Only those TI components which TI has specifically designated as military grade or "enhanced plastic" are designed and intended for use in military/aerospace applications or environments. Buyer acknowledges and agrees that any military or aerospace use of TI components which have **not** been so designated is solely at the Buyer's risk, and that Buyer is solely responsible for compliance with all legal and regulatory requirements in connection with such use.

TI has specifically designated certain components as meeting ISO/TS16949 requirements, mainly for automotive use. In any case of use of non-designated products, TI will not be responsible for any failure to meet ISO/TS16949.

Products

Audio	www.ti.com/audio
Amplifiers	amplifier.ti.com
Data Converters	dataconverter.ti.com
DLP® Products	www.dlp.com
DSP	dsp.ti.com
Clocks and Timers	www.ti.com/clocks
Interface	interface.ti.com
Logic	logic.ti.com
Power Mgmt	power.ti.com
Microcontrollers	microcontroller.ti.com
RFID	www.ti-rfid.com
OMAP Applications Processors	www.ti.com/omap
Wireless Connectivity	www.ti.com/wirelessconnectivity

Applications

Automotive and Transportation	www.ti.com/automotive
Communications and Telecom	www.ti.com/communications
Computers and Peripherals	www.ti.com/computers
Consumer Electronics	www.ti.com/consumer-apps
Energy and Lighting	www.ti.com/energy
Industrial	www.ti.com/industrial
Medical	www.ti.com/medical
Security	www.ti.com/security
Space, Avionics and Defense	www.ti.com/space-avionics-defense
Video and Imaging	www.ti.com/video

TI E2E Community

e2e.ti.com