11.3-Gbps Limiting Amplifier

FEATURES

- Up to 11.3-Gbps Operation
- Loss-of-Signal Detection (LOS)
- Adjustable Output Voltage
- Low Power Consumption
- Input Offset Cancellation
- CML Data Outputs With On-Chip, 50- Ω Back-Termination to VCC
- Single 3.3 V Supply
- Surface-Mount, Small-Footprint, 3-mm \times 3-mm, 16-Pin QFN Package

APPLICATIONS

- 10 Gigabit Ethernet Optical Transmitters
- 8 \times and 10 \times Fibre Channel Optical Transmitters
- SONET OC-192/SDH-64 Optical Transmitters
- XFP and SFP+ Transceiver Modules
- XENPAK, XPAK, X2 and 300-Pin MSA Transponder Modules
- Cable Driver and Receiver

DESCRIPTION

The ONET1191P is a high-speed, 3.3-V limiting amplifier for copper-cable and fiber-optic applications with data rates up to 11.3 Gbps.

This device provides a gain of about 40 dB which ensures a fully differential output swing for input signals as low as 5 mV_{pp}. The output amplitude can be adjusted from 400 mV_{pp} to 700 mV_{pp}. Loss-of-signal detection and output disable are also provided.

The part is available in a small-footprint, 3-mm \times 3-mm, 16-pin QFN package, typically dissipates less than 110 mW, and is characterized for operation from -40°C to 85°C .



Please be aware that an important notice concerning availability, standard warranty, and use in critical applications of Texas Instruments semiconductor products and disclaimers thereto appears at the end of this data sheet.

BLOCK DIAGRAM

A simplified block diagram of the ONET1191P is shown in Figure 1.

This compact, low-power, 11.3-Gbps limiting amplifier consists of a high-speed data path with offset cancellation (dc feedback), a loss-of-signal detection block using two peak detectors, and a band-gap voltage reference and bias current generation block.

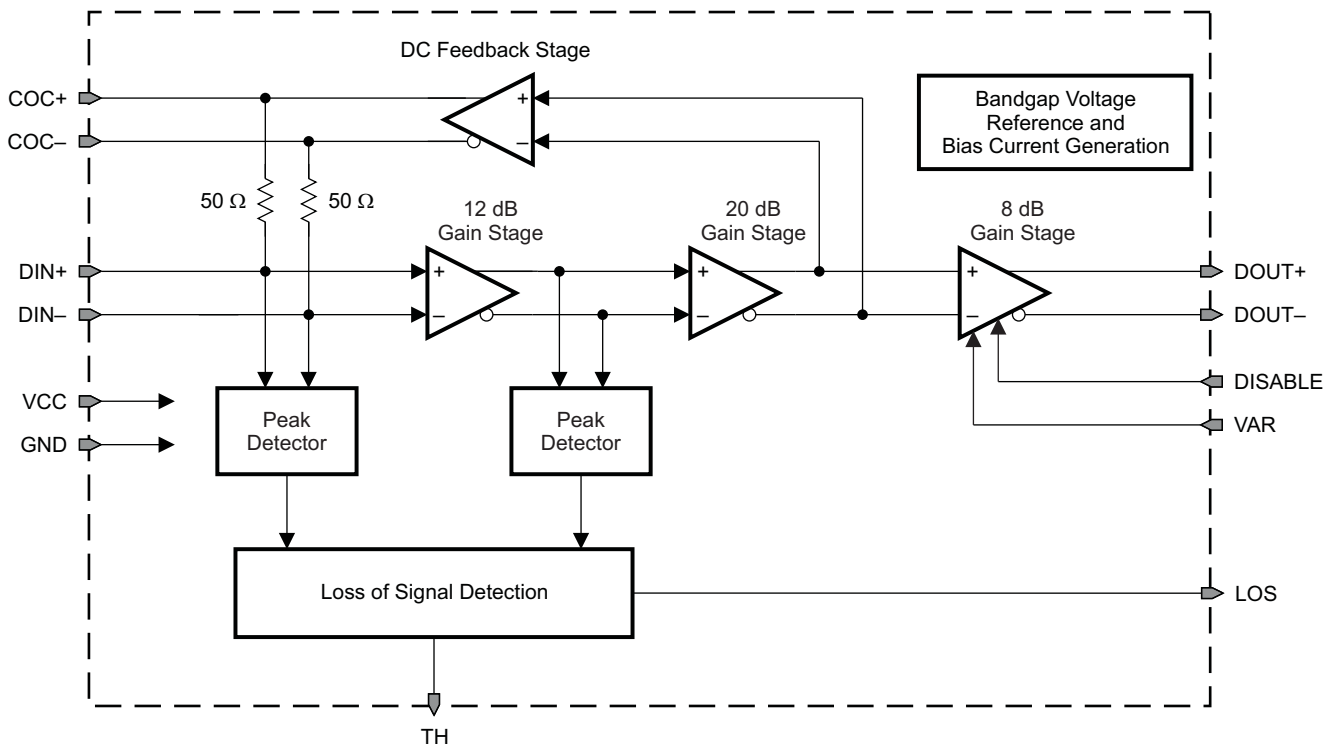

B0067-02

Figure 1. Simplified Block Diagram of the ONET1191P

HIGH-SPEED DATA PATH

The high-speed data signal is applied to the data path by means of the input signal pins, DIN+/DIN-. The data path consists of a 12-dB input gain stage with $2 \times 50\text{-}\Omega$ on-chip line-termination resistors, a second gain stage with 20 dB of gain, and a variable-gain output stage which provides another 8 dB of gain. The amplified data output signal is available at the output pins DOUT+/DOUT-, which include on-chip $2 \times 50\text{-}\Omega$ back-termination to VCC. The output amplitude can be adjusted between 400 mV_{pp} and 700 mV_{pp} by connecting an external resistor between the VAR pin and ground (GND).

A dc feedback stage compensates for internal offset voltages and thus ensures proper operation even for very small input data signals. This stage is driven by the output signal of the second gain stage. The signal is low-pass filtered, amplified, and fed back to the input of the first gain stage via the on-chip, $50\text{-}\Omega$ termination resistors. The required low-frequency cutoff is determined by an external $0.1\text{ }\mu\text{F}$ capacitor, which must be differentially connected to the COC+/COC- pins.

LOSS-OF-SIGNAL DETECTION

The peak values of the input signal and output signal of the first gain stage are monitored by two peak detectors. The peak values are compared to a predefined loss-of-signal threshold voltage inside the loss-of-signal detection block. As a result of the comparison, the LOS signal, which indicates that the input signal amplitude is below the defined threshold level, is generated.

The threshold voltage can be set within a certain range by means of an external resistor connected between the TH pin and ground.

BAND-GAP VOLTAGE AND BIAS GENERATION

The ONET1191P limiting amplifier is supplied by a single 3.3-V supply voltage connected to the VCC pins. This voltage is referred to ground (GND).

On-chip band-gap voltage circuitry generates a reference voltage, independent of supply voltage, from which all other internally required voltages and bias currents are derived.

PACKAGE

For the ONET1191P, a small-footprint, 3-mm × 3-mm, 16-pin QFN package, with a lead pitch of 0,5 mm, is used. The pinout is shown in [Figure 2](#).

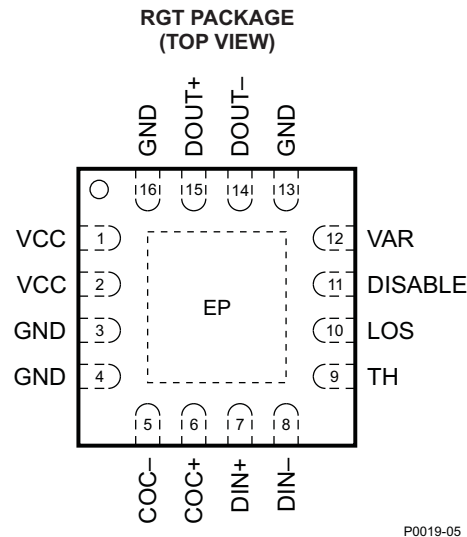

Figure 2. Pinout of ONET1191P in a 3-mm × 3-mm, 16-Pin QFN Package

TERMINAL FUNCTIONS

TERMINAL		TYPE	DESCRIPTION
NAME	NO.		
COC+	6	Analog	Offset cancellation filter capacitor plus terminal. An external 0.1 μF filter capacitor must be connected between this pin and COC– (pin 5).
COC–	5	Analog	Offset cancellation filter capacitor minus terminal. An external 0.1 μF filter capacitor must be connected between this pin and COC+ (pin 6).
DIN+	7	Analog input	Noninverted data input. On-chip, 50-Ω terminated to COC+. Differentially 100-Ω terminated to DIN–.
DIN–	8	Analog input	Inverted data input. On-chip, 50-Ω terminated to COC–. Differentially 100-Ω terminated to DIN+.
DISABLE	11	CMOS input	Disables the output stage when set to a high level
DOUT+	15	CML out	Noninverted data output. On-chip, 50-Ω back-terminated to VCC.
DOUT–	14	CML out	Inverted data output. On-chip, 50-Ω back-terminated to VCC.
GND	3, 4, 13, 16, EP	Supply	Circuit ground. Exposed die pad (EP) must be grounded.
LOS	10	Open-drain MOS	High level indicates that the input signal amplitude is below the programmed threshold level. Open-drain output. Requires an external 10-kΩ pullup resistor to VCC for proper operation.
TH	9	Analog input	LOS threshold adjustment with resistor to GND
VAR	12	Analog input	Variable output amplitude control. Output amplitude can be reduced to 400 mV _{pp} by grounding the VAR pin. Output amplitude can be set from 400 mV _{pp} to 700 mV _{pp} by connecting a 0 to 100-kΩ resistor to GND or leaving the pin open.
VCC	1, 2	Supply	3.3-V ±10% supply voltage

ABSOLUTE MAXIMUM RATINGS

over operating free-air temperature range (unless otherwise noted)⁽¹⁾

		VALUE	UNIT
V_{CC}	Supply voltage ⁽²⁾	–0.3 to 4	V
V_{DIN+} , V_{DIN-}	Voltage at DIN+, DIN– ⁽²⁾	0.5 to 4	V
V_{LOS} , V_{COC+} , V_{COC-} , V_{TH} , V_{DOUT+} , V_{DOUT-}	Voltage at LOS, COC+, COC–, TH, DOUT+, DOUT– ⁽²⁾	–0.3 to 4	V
$V_{DIN,DIFF}$	Differential voltage between DIN+ and DIN–	±1.25	V
I_{LOS}	Current into LOS	1	mA
I_{DIN+} , I_{DIN-} , I_{DOUT+} , I_{DOUT-}	Continuous current at inputs and outputs	20	mA
ESD	ESD rating at all pins	1.5	kV (HBM)
$T_{J,max}$	Maximum junction temperature	125	°C
T_{STG}	Storage temperature range	–65 to 85	°C
T_A	Characterized free-air operating temperature range	–40 to 85	°C
T_{LEAD}	Lead temperature 1,6 mm (1/16 inch) from case for 10 seconds	260	°C

- (1) Stresses beyond those listed under *absolute maximum ratings* may cause permanent damage to the device. These are stress ratings only, and functional operation of the device at these or any other conditions beyond those indicated under *recommended operating conditions* is not implied. Exposure to absolute-maximum-rated conditions for extended periods may affect device reliability.
- (2) All voltage values are with respect to network ground terminal.

RECOMMENDED OPERATING CONDITIONS

		MIN	TYP	MAX	UNIT
V_{CC}	Supply voltage	2.9	3.3	3.6	V
T_A	Operating free-air temperature	–40		85	°C
	Disable input high voltage	2			V
	Disable input low voltage			0.25	V
	Optimum LOS threshold resistor	32		62	k Ω
	R_{VAR} range	0		open	k Ω

DC ELECTRICAL CHARACTERISTICS

over recommended operating conditions, outputs connected to a 50- Ω load, R_{VAR} = open (unless otherwise noted)

PARAMETER	TEST CONDITIONS	MIN	TYP	MAX	UNIT
V_{CC}	Supply voltage	2.9	3.3	3.6	V
I_{VCC}	Supply current		33	49	mA
R_{IN}	Data input resistance		50		Ω
R_{OUT}	Data output resistance		50		Ω
	Voltage at TH pin		1.25		V
	LOS HIGH voltage	10-k Ω pullup to V_{CC} , $I_{SOURCE} = 50 \mu A$	2.4		
	LOS LOW voltage	10-k Ω pullup to V_{CC} , $I_{SINK} = 200 \mu A$		0.5	V

AC ELECTRICAL CHARACTERISTICS

over recommended operating conditions, outputs connected to a 50-Ω load, R_{VAR} = open (unless otherwise noted). Typical operating condition is at V_{CC} = 3.3 V and T_A = 25°C.

PARAMETER		TEST CONDITIONS	MIN	TYP	MAX	UNIT
f_{3dB-H}	High-frequency –3-dB bandwidth		8	11	15	GHz
f_{3dB-L}	Low-frequency –3-dB bandwidth	$C_{OC} = 0.1 \mu F$, ac coupling capacitors = 0.1 μF		30		kHz
$V_{IN,MIN}$	Data input sensitivity	K28.5 at 11.3 Gbps, BER < 10 ⁻¹²		2.5	5	mV _{pp}
		$V_{OD-min} \geq 0.95 \times V_{OD}$ (output limited)		10	20	
A	Small-signal gain		34	40	44	dB
$V_{IN,MAX}$	Data input overload		2000			mV _{pp}
DJ	Deterministic jitter	$V_{IN} = 5 \text{ mV}_{pp}$, K28.5 at 11.3 Gbps		4	7	ps _{pp}
		$V_{IN} = 20 \text{ mV}_{pp}$, K28.5 at 11.3 Gbps		4	9	
RJ	Random jitter	Input = 5 mV _{pp}		1.6		ps _{RMS}
		Input = 20 mV _{pp}		0.7		
V_{OD}	Differential data output voltage	$V_{IN} \geq 20 \text{ mV}_{pp}$, DISABLE = LOW	600	700	900	mV _{pp}
		DISABLE = HIGH		25	100	
t_r	Output rise time	20% to 80%, $V_{IN} \geq 20 \text{ mV}_{pp}$		25	35	ps
t_f	Output fall time	20% to 80%, $V_{IN} \geq 20 \text{ mV}_{pp}$		25	35	ps
V_{TH}	LOS assert threshold range	K28.5 pattern at 10.7 Gbps, $R_{TH} = 62 \text{ k}\Omega$		40		mV _{pp}
		K28.5 pattern at 10.7 Gbps, $R_{TH} = 32 \text{ k}\Omega$		65		
	LOS threshold variation	Versus temperature		3		dB
		Versus supply voltage V_{CC}		1		dB
	LOS hysteresis	K28.5 pattern at 11.3 Gbps	1.5		7	dB
t_{LOS_AST}	LOS assert time			1300	2000	ns
t_{LOS_DEA}	LOS deassert time			120		ns
t_{DIS}	Disable response time			90		ns

TYPICAL OPERATION CHARACTERISTICS

Typical operating condition is at $V_{CC} = 3.3\text{ V}$, $T_A = 25^\circ\text{C}$, and $R_{VAR} = \text{open}$ (unless otherwise noted)

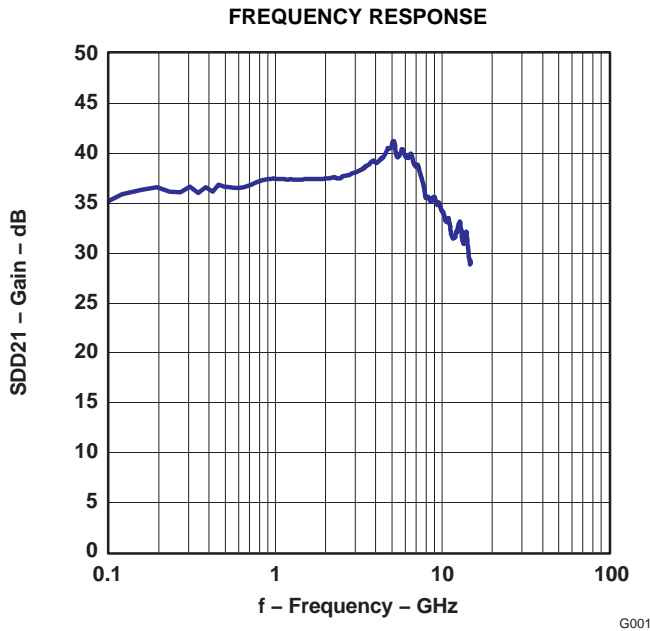

Figure 3.

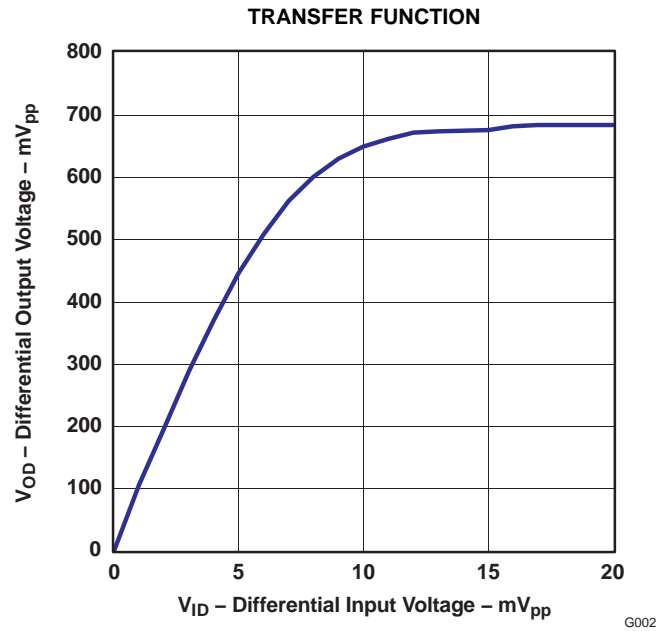

Figure 4.

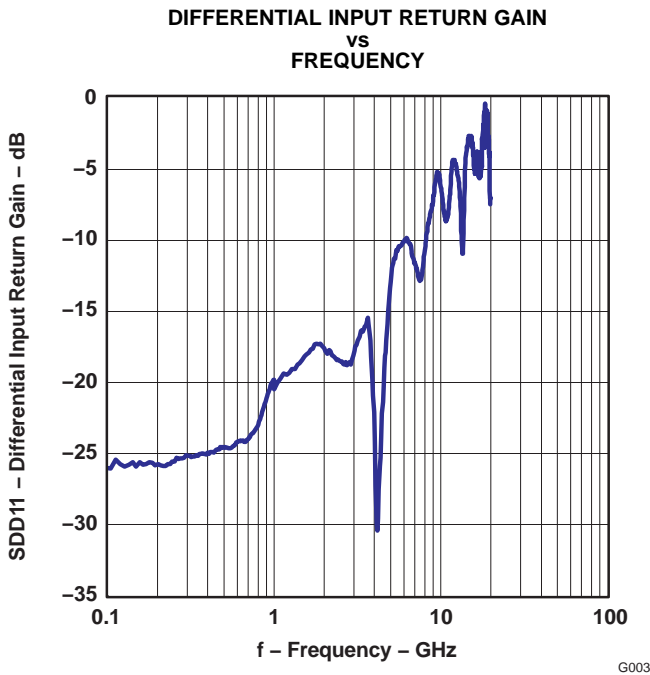

Figure 5.

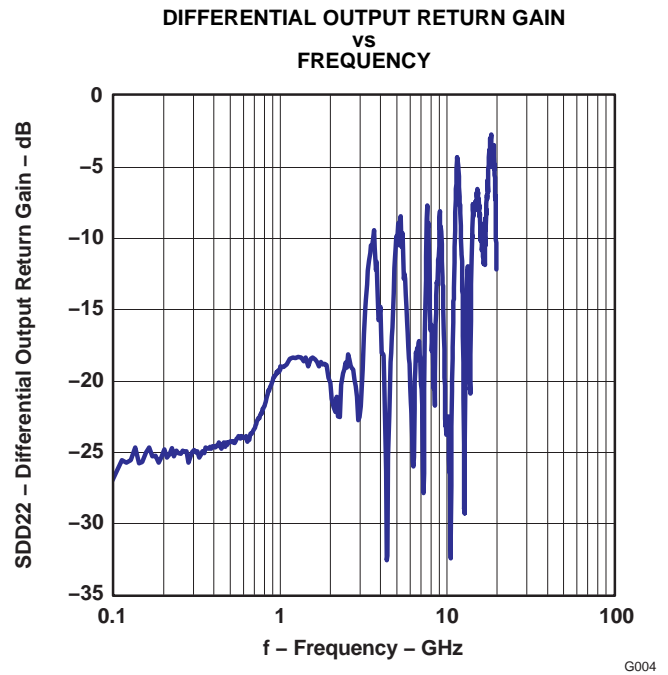

Figure 6.

TYPICAL OPERATION CHARACTERISTICS (continued)

Typical operating condition is at $V_{CC} = 3.3\text{ V}$, $T_A = 25^\circ\text{C}$, and $R_{VAR} = \text{open}$ (unless otherwise noted)

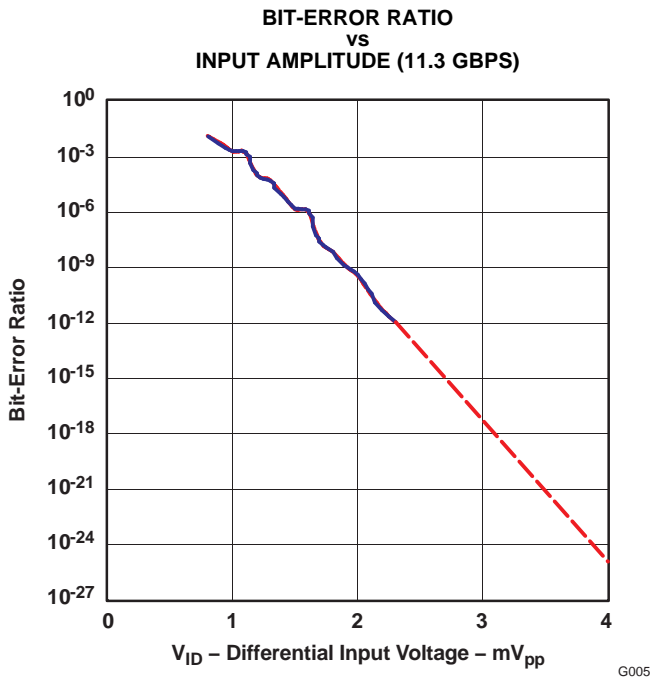

Figure 7.

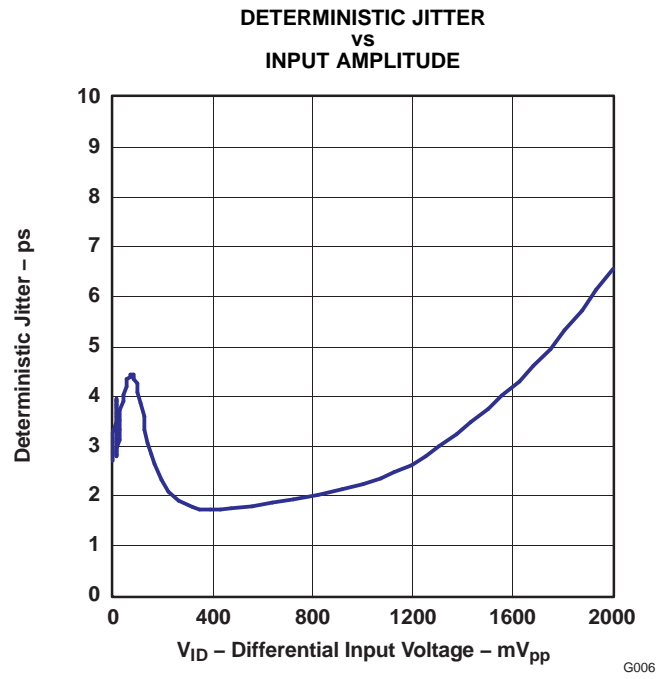

Figure 8.

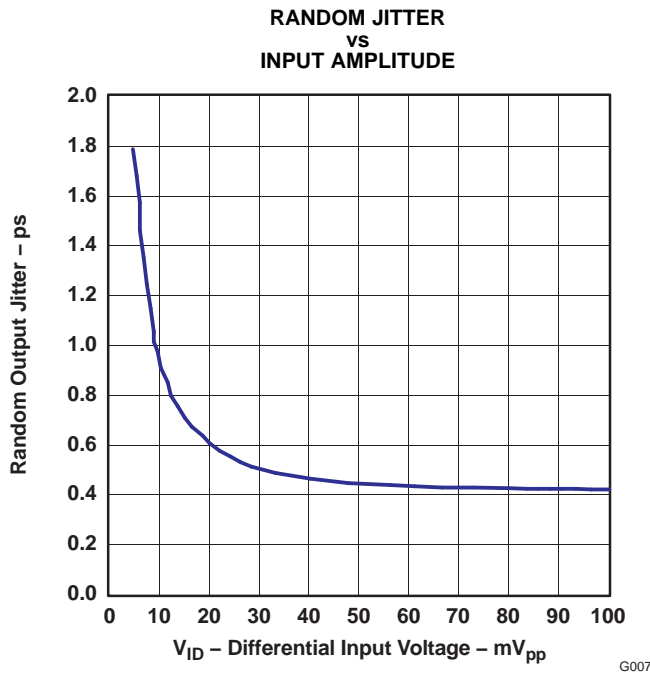

Figure 9.

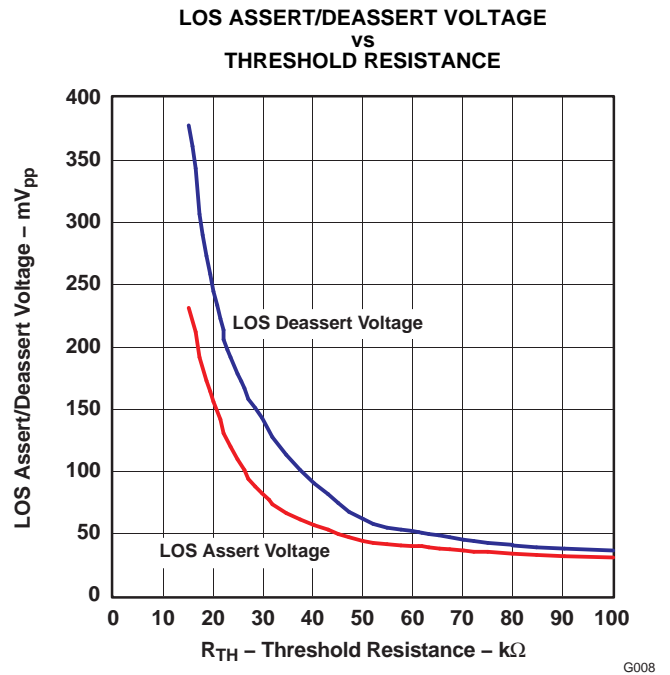

Figure 10.

TYPICAL OPERATION CHARACTERISTICS (continued)

Typical operating condition is at $V_{CC} = 3.3\text{ V}$, $T_A = 25^\circ\text{C}$, and $R_{VAR} = \text{open}$ (unless otherwise noted)

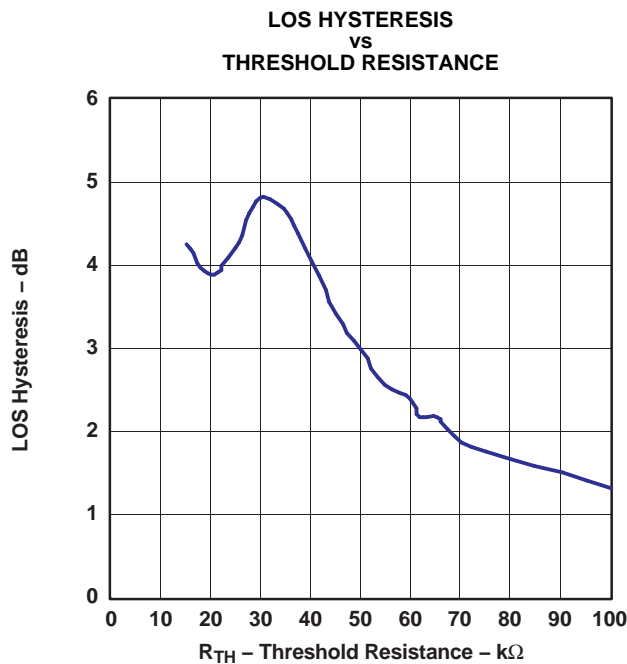

Figure 11.

G009

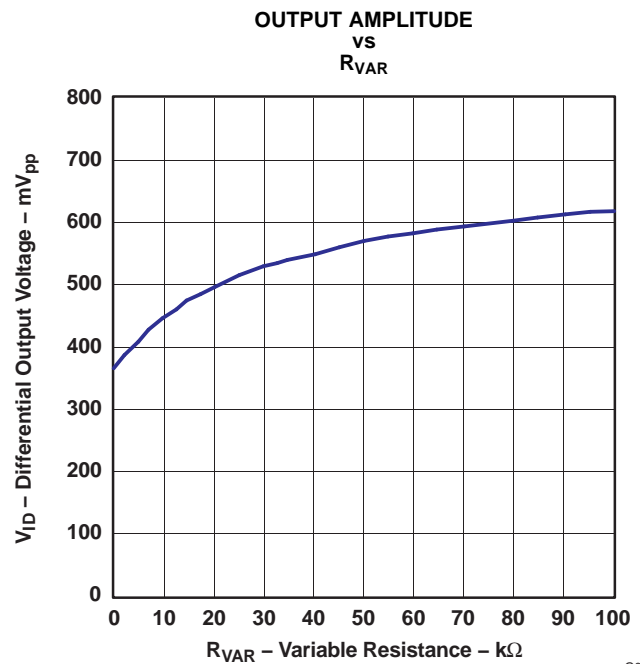

Figure 12.

G010

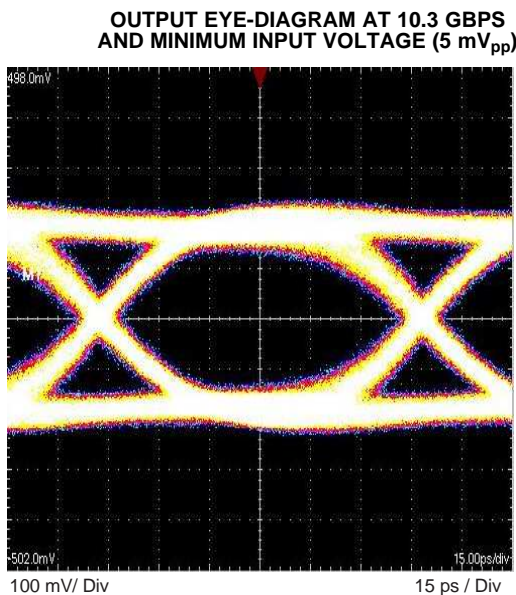

Figure 13.

G011

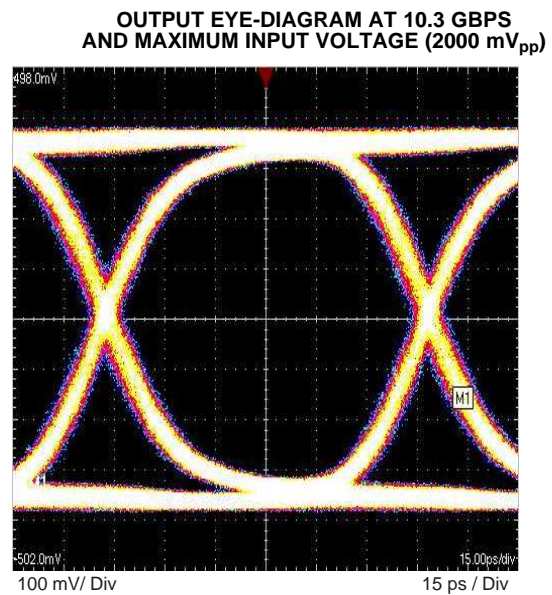

Figure 14.

G012

TYPICAL OPERATION CHARACTERISTICS (continued)

Typical operating condition is at $V_{CC} = 3.3\text{ V}$, $T_A = 25^\circ\text{C}$, and $R_{VAR} = \text{open}$ (unless otherwise noted)

**OUTPUT EYE-DIAGRAM AT 8.5 GBPS
AND MINIMUM INPUT VOLTAGE (5 mV_{pp})**

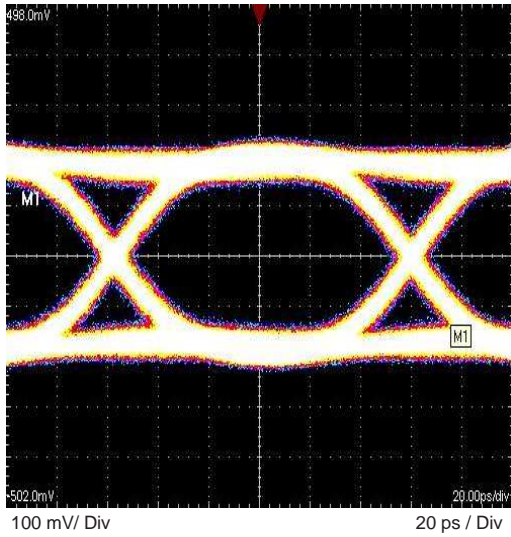

G013

Figure 15.

**OUTPUT EYE-DIAGRAM AT 8.5 GBPS
AND MAXIMUM INPUT VOLTAGE (2000 mV_{pp})**

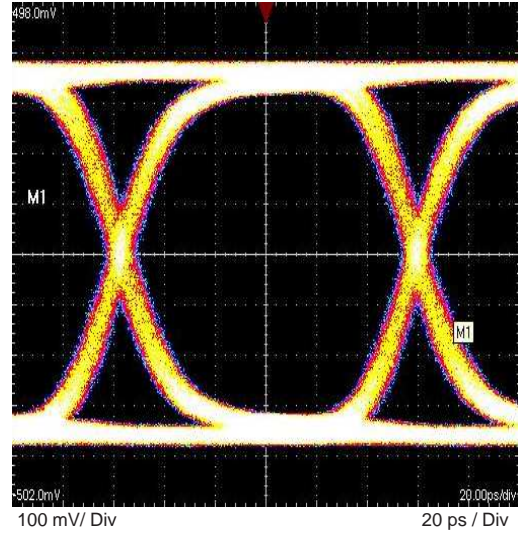

G014

Figure 16.

APPLICATION INFORMATION

Figure 17 shows a typical application circuit using the ONET1191P. The output amplitude can be adjusted with R_{VAR} and the LOS assert voltage is adjusted with R_{TH} .

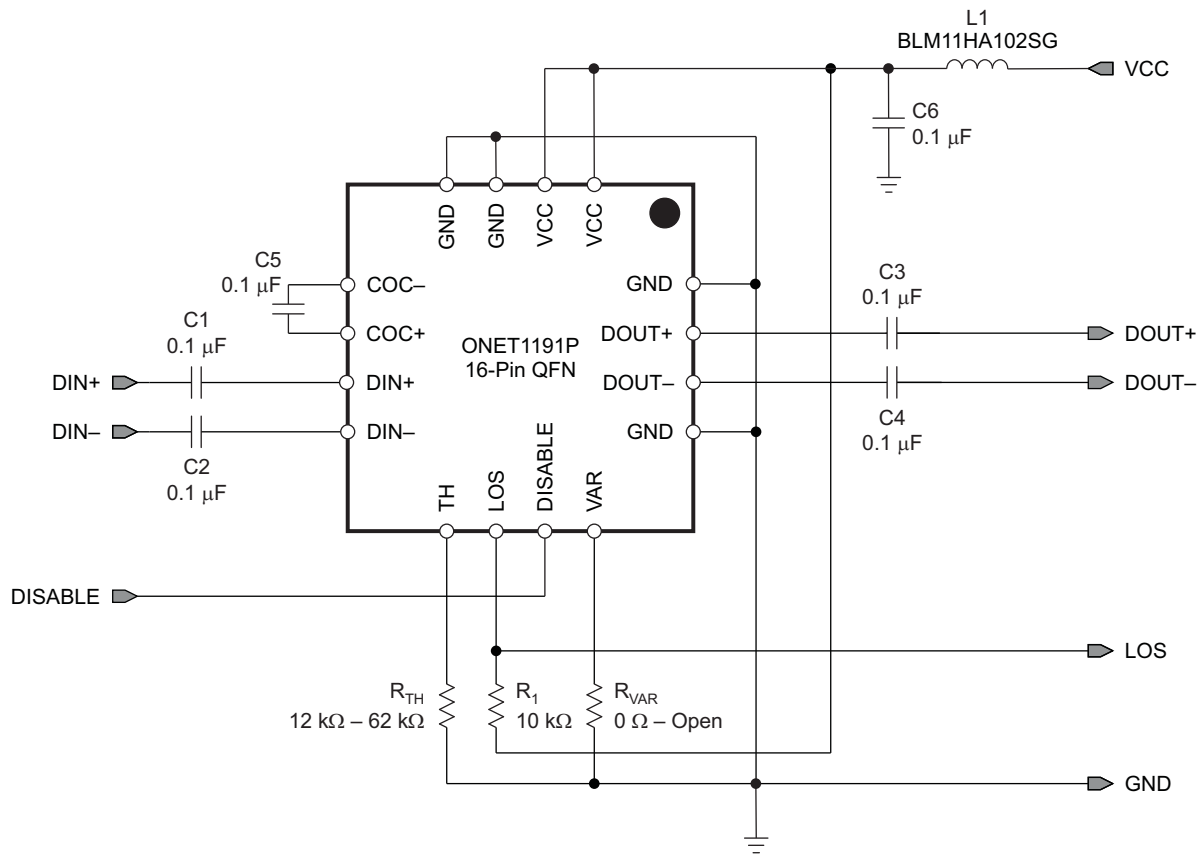

S0099-03

Figure 17. Basic Application Circuit

PACKAGING INFORMATION

Orderable Device	Status (1)	Package Type	Package Drawing	Pins	Package Qty	Eco Plan (2)	Lead/Ball Finish	MSL Peak Temp (3)	Op Temp (°C)	Top-Side Markings (4)	Samples
ONET1191PRGTR	ACTIVE	QFN	RGT	16	3000	Green (RoHS & no Sb/Br)	CU NIPDAU	Level-2-260C-1 YEAR	-40 to 85	191P	Samples
ONET1191PRGTRG4	ACTIVE	QFN	RGT	16	3000	Green (RoHS & no Sb/Br)	CU NIPDAU	Level-2-260C-1 YEAR	-40 to 85	191P	Samples
ONET1191PRGTT	ACTIVE	QFN	RGT	16	250	Green (RoHS & no Sb/Br)	CU NIPDAU	Level-2-260C-1 YEAR	-40 to 85	191P	Samples
ONET1191PRGTTG4	ACTIVE	QFN	RGT	16	250	Green (RoHS & no Sb/Br)	CU NIPDAU	Level-2-260C-1 YEAR	-40 to 85	191P	Samples

(1) The marketing status values are defined as follows:

ACTIVE: Product device recommended for new designs.

LIFEBUY: TI has announced that the device will be discontinued, and a lifetime-buy period is in effect.

NRND: Not recommended for new designs. Device is in production to support existing customers, but TI does not recommend using this part in a new design.

PREVIEW: Device has been announced but is not in production. Samples may or may not be available.

OBSOLETE: TI has discontinued the production of the device.

(2) Eco Plan - The planned eco-friendly classification: Pb-Free (RoHS), Pb-Free (RoHS Exempt), or Green (RoHS & no Sb/Br) - please check <http://www.ti.com/productcontent> for the latest availability information and additional product content details.

TBD: The Pb-Free/Green conversion plan has not been defined.

Pb-Free (RoHS): TI's terms "Lead-Free" or "Pb-Free" mean semiconductor products that are compatible with the current RoHS requirements for all 6 substances, including the requirement that lead not exceed 0.1% by weight in homogeneous materials. Where designed to be soldered at high temperatures, TI Pb-Free products are suitable for use in specified lead-free processes.

Pb-Free (RoHS Exempt): This component has a RoHS exemption for either 1) lead-based flip-chip solder bumps used between the die and package, or 2) lead-based die adhesive used between the die and leadframe. The component is otherwise considered Pb-Free (RoHS compatible) as defined above.

Green (RoHS & no Sb/Br): TI defines "Green" to mean Pb-Free (RoHS compatible), and free of Bromine (Br) and Antimony (Sb) based flame retardants (Br or Sb do not exceed 0.1% by weight in homogeneous material)

(3) MSL, Peak Temp. -- The Moisture Sensitivity Level rating according to the JEDEC industry standard classifications, and peak solder temperature.

(4) Multiple Top-Side Markings will be inside parentheses. Only one Top-Side Marking contained in parentheses and separated by a "~" will appear on a device. If a line is indented then it is a continuation of the previous line and the two combined represent the entire Top-Side Marking for that device.

Important Information and Disclaimer: The information provided on this page represents TI's knowledge and belief as of the date that it is provided. TI bases its knowledge and belief on information provided by third parties, and makes no representation or warranty as to the accuracy of such information. Efforts are underway to better integrate information from third parties. TI has taken and continues to take reasonable steps to provide representative and accurate information but may not have conducted destructive testing or chemical analysis on incoming materials and chemicals. TI and TI suppliers consider certain information to be proprietary, and thus CAS numbers and other limited information may not be available for release.

In no event shall TI's liability arising out of such information exceed the total purchase price of the TI part(s) at issue in this document sold by TI to Customer on an annual basis.

TAPE AND REEL INFORMATION

QUADRANT ASSIGNMENTS FOR PIN 1 ORIENTATION IN TAPE

*All dimensions are nominal

Device	Package Type	Package Drawing	Pins	SPQ	Reel Diameter (mm)	Reel Width W1 (mm)	A0 (mm)	B0 (mm)	K0 (mm)	P1 (mm)	W (mm)	Pin1 Quadrant
ONET1191PRGTR	QFN	RGT	16	3000	330.0	12.4	3.3	3.3	1.1	8.0	12.0	Q2
ONET1191PRGTT	QFN	RGT	16	250	180.0	12.4	3.3	3.3	1.1	8.0	12.0	Q2

TAPE AND REEL BOX DIMENSIONS

*All dimensions are nominal

Device	Package Type	Package Drawing	Pins	SPQ	Length (mm)	Width (mm)	Height (mm)
ONET1191PRGTR	QFN	RGT	16	3000	336.6	336.6	28.6
ONET1191PRGTT	QFN	RGT	16	250	210.0	185.0	35.0

RGT 16

GENERIC PACKAGE VIEW

VQFN - 1 mm max height

PLASTIC QUAD FLATPACK - NO LEAD

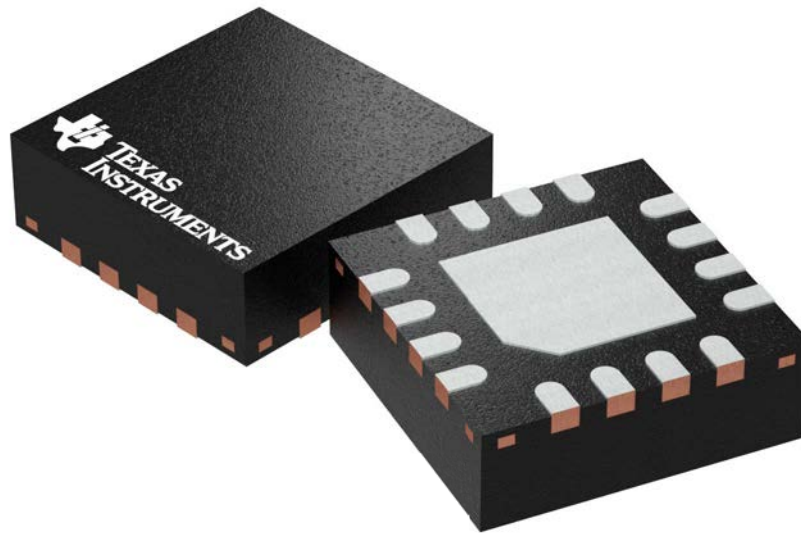

Images above are just a representation of the package family, actual package may vary.
Refer to the product data sheet for package details.

4203495/1

RGT0016C

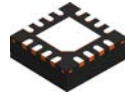

PACKAGE OUTLINE

VQFN - 1 mm max height

PLASTIC QUAD FLATPACK - NO LEAD

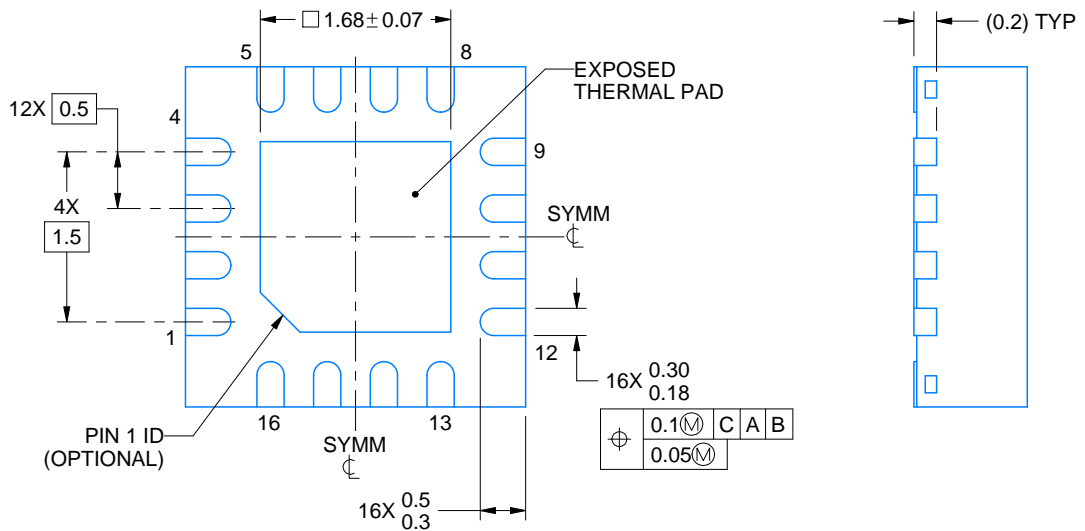
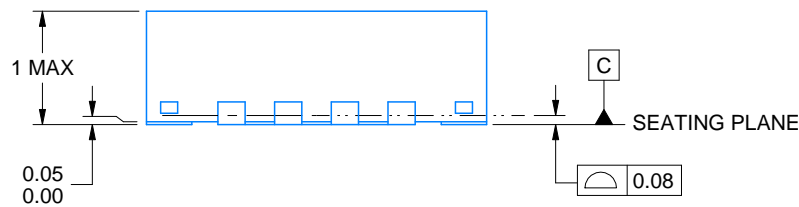
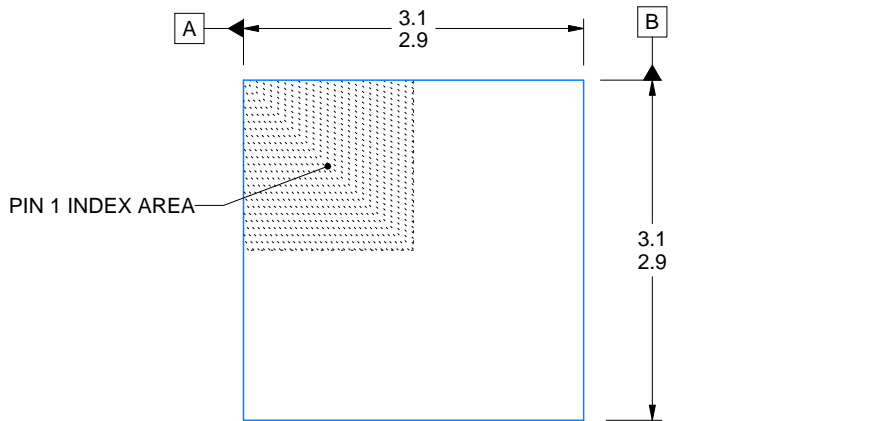

4222419/B 11/2016

NOTES:

1. All linear dimensions are in millimeters. Any dimensions in parenthesis are for reference only. Dimensioning and tolerancing per ASME Y14.5M.
2. This drawing is subject to change without notice.
3. The package thermal pad must be soldered to the printed circuit board for thermal and mechanical performance.

EXAMPLE BOARD LAYOUT

RGT0016C

VQFN - 1 mm max height

PLASTIC QUAD FLATPACK - NO LEAD

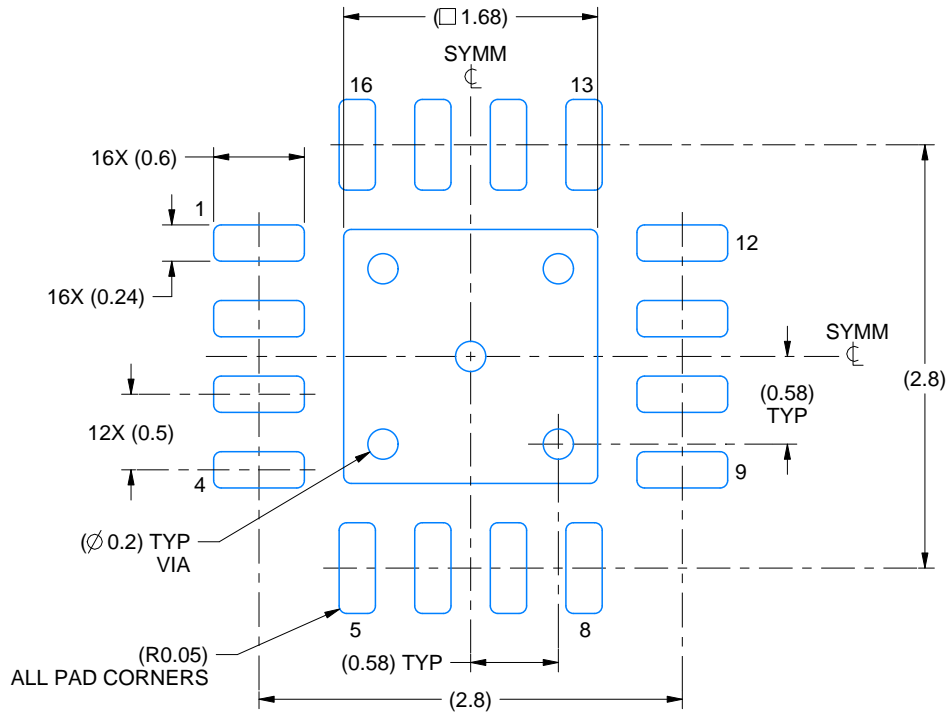

LAND PATTERN EXAMPLE
SCALE:20X

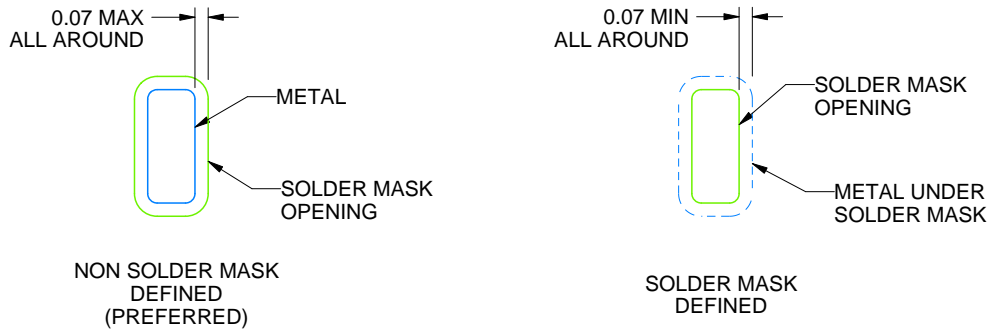

SOLDER MASK DETAILS

4222419/B 11/2016

NOTES: (continued)

- This package is designed to be soldered to a thermal pad on the board. For more information, see Texas Instruments literature number SLUA271 (www.ti.com/lit/slua271).
- Vias are optional depending on application, refer to device data sheet. If any vias are implemented, refer to their locations shown on this view. It is recommended that vias under paste be filled, plugged or tented.

EXAMPLE STENCIL DESIGN

RGT0016C

VQFN - 1 mm max height

PLASTIC QUAD FLATPACK - NO LEAD

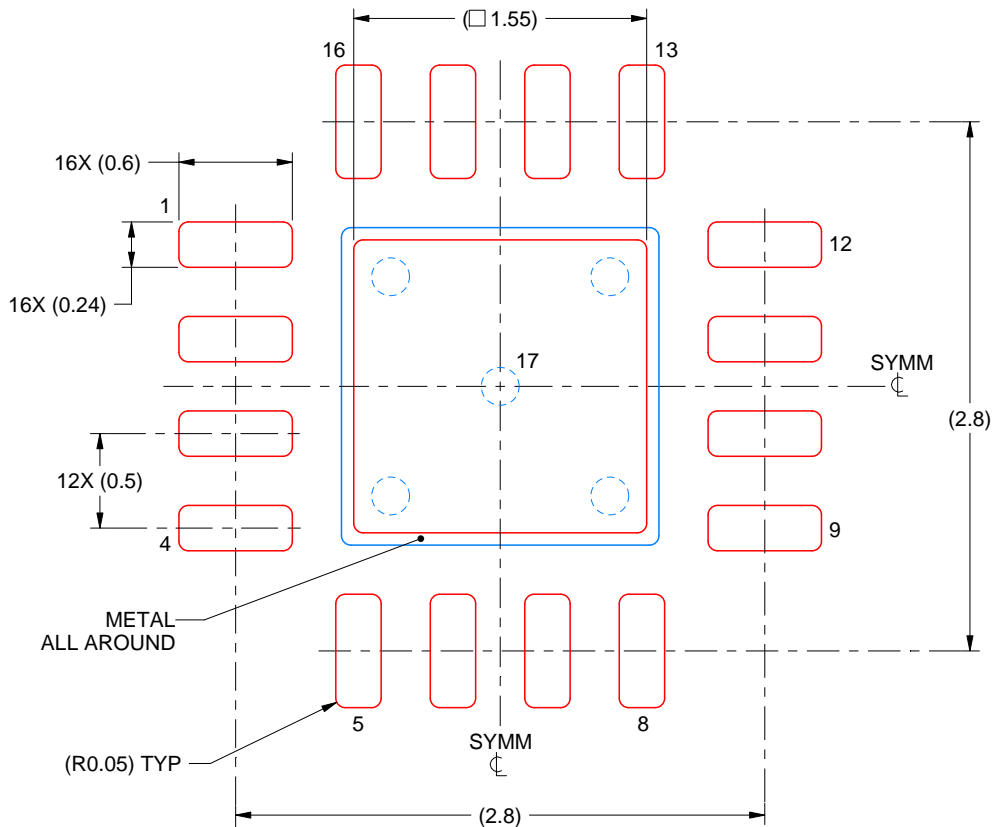

SOLDER PASTE EXAMPLE
BASED ON 0.125 mm THICK STENCIL

EXPOSED PAD 17:
85% PRINTED SOLDER COVERAGE BY AREA UNDER PACKAGE
SCALE:25X

4222419/B 11/2016

NOTES: (continued)

6. Laser cutting apertures with trapezoidal walls and rounded corners may offer better paste release. IPC-7525 may have alternate design recommendations.

IMPORTANT NOTICE

Texas Instruments Incorporated (TI) reserves the right to make corrections, enhancements, improvements and other changes to its semiconductor products and services per JESD46, latest issue, and to discontinue any product or service per JESD48, latest issue. Buyers should obtain the latest relevant information before placing orders and should verify that such information is current and complete.

TI's published terms of sale for semiconductor products (<http://www.ti.com/sc/docs/stdterms.htm>) apply to the sale of packaged integrated circuit products that TI has qualified and released to market. Additional terms may apply to the use or sale of other types of TI products and services.

Reproduction of significant portions of TI information in TI data sheets is permissible only if reproduction is without alteration and is accompanied by all associated warranties, conditions, limitations, and notices. TI is not responsible or liable for such reproduced documentation. Information of third parties may be subject to additional restrictions. Resale of TI products or services with statements different from or beyond the parameters stated by TI for that product or service voids all express and any implied warranties for the associated TI product or service and is an unfair and deceptive business practice. TI is not responsible or liable for any such statements.

Buyers and others who are developing systems that incorporate TI products (collectively, "Designers") understand and agree that Designers remain responsible for using their independent analysis, evaluation and judgment in designing their applications and that Designers have full and exclusive responsibility to assure the safety of Designers' applications and compliance of their applications (and of all TI products used in or for Designers' applications) with all applicable regulations, laws and other applicable requirements. Designer represents that, with respect to their applications, Designer has all the necessary expertise to create and implement safeguards that (1) anticipate dangerous consequences of failures, (2) monitor failures and their consequences, and (3) lessen the likelihood of failures that might cause harm and take appropriate actions. Designer agrees that prior to using or distributing any applications that include TI products, Designer will thoroughly test such applications and the functionality of such TI products as used in such applications.

TI's provision of technical, application or other design advice, quality characterization, reliability data or other services or information, including, but not limited to, reference designs and materials relating to evaluation modules, (collectively, "TI Resources") are intended to assist designers who are developing applications that incorporate TI products; by downloading, accessing or using TI Resources in any way, Designer (individually or, if Designer is acting on behalf of a company, Designer's company) agrees to use any particular TI Resource solely for this purpose and subject to the terms of this Notice.

TI's provision of TI Resources does not expand or otherwise alter TI's applicable published warranties or warranty disclaimers for TI products, and no additional obligations or liabilities arise from TI providing such TI Resources. TI reserves the right to make corrections, enhancements, improvements and other changes to its TI Resources. TI has not conducted any testing other than that specifically described in the published documentation for a particular TI Resource.

Designer is authorized to use, copy and modify any individual TI Resource only in connection with the development of applications that include the TI product(s) identified in such TI Resource. NO OTHER LICENSE, EXPRESS OR IMPLIED, BY ESTOPPEL OR OTHERWISE TO ANY OTHER TI INTELLECTUAL PROPERTY RIGHT, AND NO LICENSE TO ANY TECHNOLOGY OR INTELLECTUAL PROPERTY RIGHT OF TI OR ANY THIRD PARTY IS GRANTED HEREIN, including but not limited to any patent right, copyright, mask work right, or other intellectual property right relating to any combination, machine, or process in which TI products or services are used. Information regarding or referencing third-party products or services does not constitute a license to use such products or services, or a warranty or endorsement thereof. Use of TI Resources may require a license from a third party under the patents or other intellectual property of the third party, or a license from TI under the patents or other intellectual property of TI.

TI RESOURCES ARE PROVIDED "AS IS" AND WITH ALL FAULTS. TI DISCLAIMS ALL OTHER WARRANTIES OR REPRESENTATIONS, EXPRESS OR IMPLIED, REGARDING RESOURCES OR USE THEREOF, INCLUDING BUT NOT LIMITED TO ACCURACY OR COMPLETENESS, TITLE, ANY EPIDEMIC FAILURE WARRANTY AND ANY IMPLIED WARRANTIES OF MERCHANTABILITY, FITNESS FOR A PARTICULAR PURPOSE, AND NON-INFRINGEMENT OF ANY THIRD PARTY INTELLECTUAL PROPERTY RIGHTS. TI SHALL NOT BE LIABLE FOR AND SHALL NOT DEFEND OR INDEMNIFY DESIGNER AGAINST ANY CLAIM, INCLUDING BUT NOT LIMITED TO ANY INFRINGEMENT CLAIM THAT RELATES TO OR IS BASED ON ANY COMBINATION OF PRODUCTS EVEN IF DESCRIBED IN TI RESOURCES OR OTHERWISE. IN NO EVENT SHALL TI BE LIABLE FOR ANY ACTUAL, DIRECT, SPECIAL, COLLATERAL, INDIRECT, PUNITIVE, INCIDENTAL, CONSEQUENTIAL OR EXEMPLARY DAMAGES IN CONNECTION WITH OR ARISING OUT OF TI RESOURCES OR USE THEREOF, AND REGARDLESS OF WHETHER TI HAS BEEN ADVISED OF THE POSSIBILITY OF SUCH DAMAGES.

Unless TI has explicitly designated an individual product as meeting the requirements of a particular industry standard (e.g., ISO/TS 16949 and ISO 26262), TI is not responsible for any failure to meet such industry standard requirements.

Where TI specifically promotes products as facilitating functional safety or as compliant with industry functional safety standards, such products are intended to help enable customers to design and create their own applications that meet applicable functional safety standards and requirements. Using products in an application does not by itself establish any safety features in the application. Designers must ensure compliance with safety-related requirements and standards applicable to their applications. Designer may not use any TI products in life-critical medical equipment unless authorized officers of the parties have executed a special contract specifically governing such use. Life-critical medical equipment is medical equipment where failure of such equipment would cause serious bodily injury or death (e.g., life support, pacemakers, defibrillators, heart pumps, neurostimulators, and implantables). Such equipment includes, without limitation, all medical devices identified by the U.S. Food and Drug Administration as Class III devices and equivalent classifications outside the U.S.

TI may expressly designate certain products as completing a particular qualification (e.g., Q100, Military Grade, or Enhanced Product). Designers agree that it has the necessary expertise to select the product with the appropriate qualification designation for their applications and that proper product selection is at Designers' own risk. Designers are solely responsible for compliance with all legal and regulatory requirements in connection with such selection.

Designer will fully indemnify TI and its representatives against any damages, costs, losses, and/or liabilities arising out of Designer's non-compliance with the terms and provisions of this Notice.