

# TLE208x, TLE208xA, TLE208xY EXCALIBUR HIGH-SPEED JFET-INPUT OPERATIONAL AMPLIFIERS

SLOS182B – FEBRUARY 1997 – REVISED JUNE 2001

- Direct Upgrades to TL05x, TL07x, and TL08x BiFET Operational Amplifiers
- Greater Than 2× Bandwidth (10 MHz) and 3× Slew Rate (45 V/μs) Than TL08x
- On-Chip Offset Voltage Trimming for Improved DC Performance
- Wider Supply Rails Increase Dynamic Signal Range to ±19 V

## description

The TLE208x series of JFET-input operational amplifiers more than double the bandwidth and triple the slew rate of the TL07x and TL08x families of BiFET operational amplifiers. The TLE208x also have wider supply-voltage rails, increasing the dynamic-signal range for BiFET circuits to ±19 V. On-chip zener trimming of offset voltage yields precision grades for greater accuracy in dc-coupled applications. The TLE208x are pin-compatible with lower performance BiFET operational amplifiers for ease in improving performance in existing designs.

BiFET operational amplifiers offer the inherently higher input impedance of the JFET-input transistors, without sacrificing the output drive associated with bipolar amplifiers. This makes these amplifiers better suited for interfacing with high-impedance sensors or very low level ac signals. They also feature inherently better ac response than bipolar or CMOS devices having comparable power consumption.

Because BiFET operational amplifiers are designed for use with dual power supplies, care must be taken to observe common-mode input-voltage limits and output voltage swing when operating from a single supply. DC biasing of the input signal is required and loads should be terminated to a virtual ground node at mid-supply. Texas Instruments TLE2426 integrated virtual ground generator is useful when operating BiFET amplifiers from single supplies.

The TLE208x are fully specified at ±15 V and ±5 V. For operation in low-voltage and/or single-supply systems, Texas Instruments LinCMOS™ families of operational amplifiers (TLC- and TLV-prefix) are recommended. When moving from BiFET to CMOS amplifiers, particular attention should be paid to slew rate and bandwidth requirements and output loading.

For BiFET circuits requiring low noise and/or tighter dc precision, the TLE207x offer the same ac response as the TLE208x with more stringent dc and noise specifications.



Please be aware that an important notice concerning availability, standard warranty, and use in critical applications of Texas Instruments semiconductor products and disclaimers thereto appears at the end of this data sheet.

LinCMOS is a trademark of Texas Instruments.

PRODUCTION DATA information is current as of publication date. Products conform to specifications per the terms of Texas Instruments standard warranty. Production processing does not necessarily include testing of all parameters.



POST OFFICE BOX 655303 • DALLAS, TEXAS 75265

Copyright © 2001, Texas Instruments Incorporated

# TLE208x, TLE208xA, TLE208xY EXCALIBUR HIGH-SPEED JFET-INPUT OPERATIONAL AMPLIFIERS

SLOS182B – FEBRUARY 1997 – REVISED JUNE 2001

## TLE2081 AVAILABLE OPTIONS

T <sub>A</sub>	V <sub>IOmax</sub> AT 25°C	PACKAGED DEVICES				CHIP FORM (Y)
		SMALL OUTLINE (D)	CHIP CARRIER (FK)	CERAMIC DIP (JG)	PLASTIC DIP (P)	
0°C to 70°C	3 mV 6 mV	TLE2081ACD TLE2081CD	—	—	TLE2081ACP TLE2081CP	— TLE2081Y
–40°C to 85°C	3 mV 6 mV	TLE2081AID TLE2081ID	—	—	TLE2081AIP TLE2081IP	—
–55°C to 125°C	3 mV 6 mV	—	TLE2081AMFK TLE2081MFK	TLE2081AMJG TLE2081MJG	—	—

† The D packages are available taped and reeled. Add R suffix to device type (e.g., TLE2081ACDR).

‡ Chip forms are tested at T<sub>A</sub> = 25°C only.

## TLE2082 AVAILABLE OPTIONS

T <sub>A</sub>	V <sub>IOmax</sub> AT 25°C	PACKAGED DEVICES				CHIP FORM (Y)
		SMALL OUTLINE (D)	CHIP CARRIER (FK)	CERAMIC DIP (JG)	PLASTIC DIP (P)	
0°C to 70°C	4 mV 7 mV	TLE2082ACD TLE2082CD	—	—	TLE2082ACP TLE2082CP	—
–40°C to 85°C	4 mV 7 mV	TLE2082AID TLE2082ID	—	—	TLE2082AIP TLE2082IP	TLE2082Y
–55°C to 125°C	4 mV 7 mV	TLE2082AMD TLE2082MD	TLE2082AMFK TLE2082MFK	TLE2082AMJG TLE2082MJG	TLE2082AMP TLE2082MP	—

† The D packages are available taped and reeled. Add R suffix to device type (e.g., TLE2082ACDR).

‡ Chip forms are tested at T<sub>A</sub> = 25°C only.

## TLE2084 AVAILABLE OPTIONS

T <sub>A</sub>	V <sub>IOmax</sub> AT 25°C	PACKAGED DEVICES				CHIP FORM (Y)
		SMALL OUTLINE (DW)	CHIP CARRIER (FK)	CERAMIC DIP (J)	PLASTIC DIP (N)	
0°C to 70°C	4 mV 7 mV	TLE2084ACDW TLE2084CDW	—	—	TLE2084ACN TLE2084CN	— TLE2084Y
–55°C to 125°C	4 mV 7 mV	—	TLE2084AMFK TLE2084MFK	TLE2084AMJ TLE2084MJ	—	—

† The DW packages are available taped and reeled. Add R suffix to device type (e.g., TLE2084ACDWR).

‡ Chip forms are tested at T<sub>A</sub> = 25°C only.



# TLE208x, TLE208xA, TLE208xY EXCALIBUR HIGH-SPEED JFET-INPUT OPERATIONAL AMPLIFIERS

SLOS182B – FEBRUARY 1997 – REVISED JUNE 2001

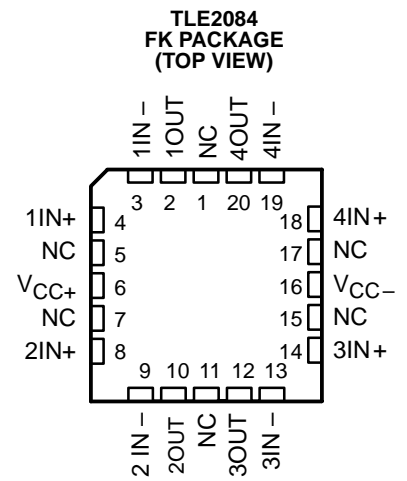
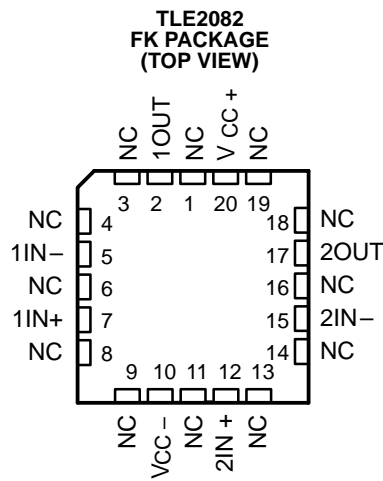
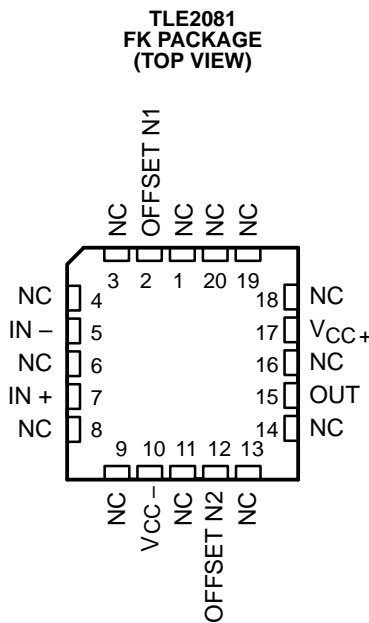
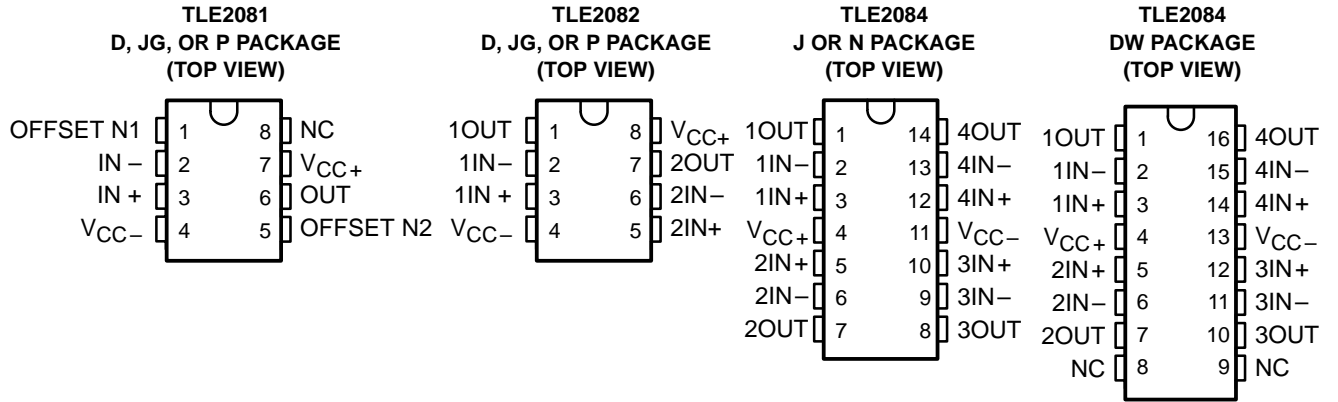

NC – No internal connection

## symbol

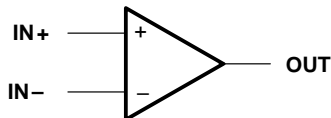

# TLE208x, TLE208xA, TLE208xY EXCALIBUR HIGH-SPEED JFET-INPUT OPERATIONAL AMPLIFIERS

SLOS182B – FEBRUARY 1997 – REVISED JUNE 2001

## TLE2081Y chip information

This chip, when properly assembled, displays characteristics similar to the TLE2081. Thermal compression or ultrasonic bonding may be used on the doped-aluminum bonding pads. Chips may be mounted with conductive epoxy or a gold-silicon preform.

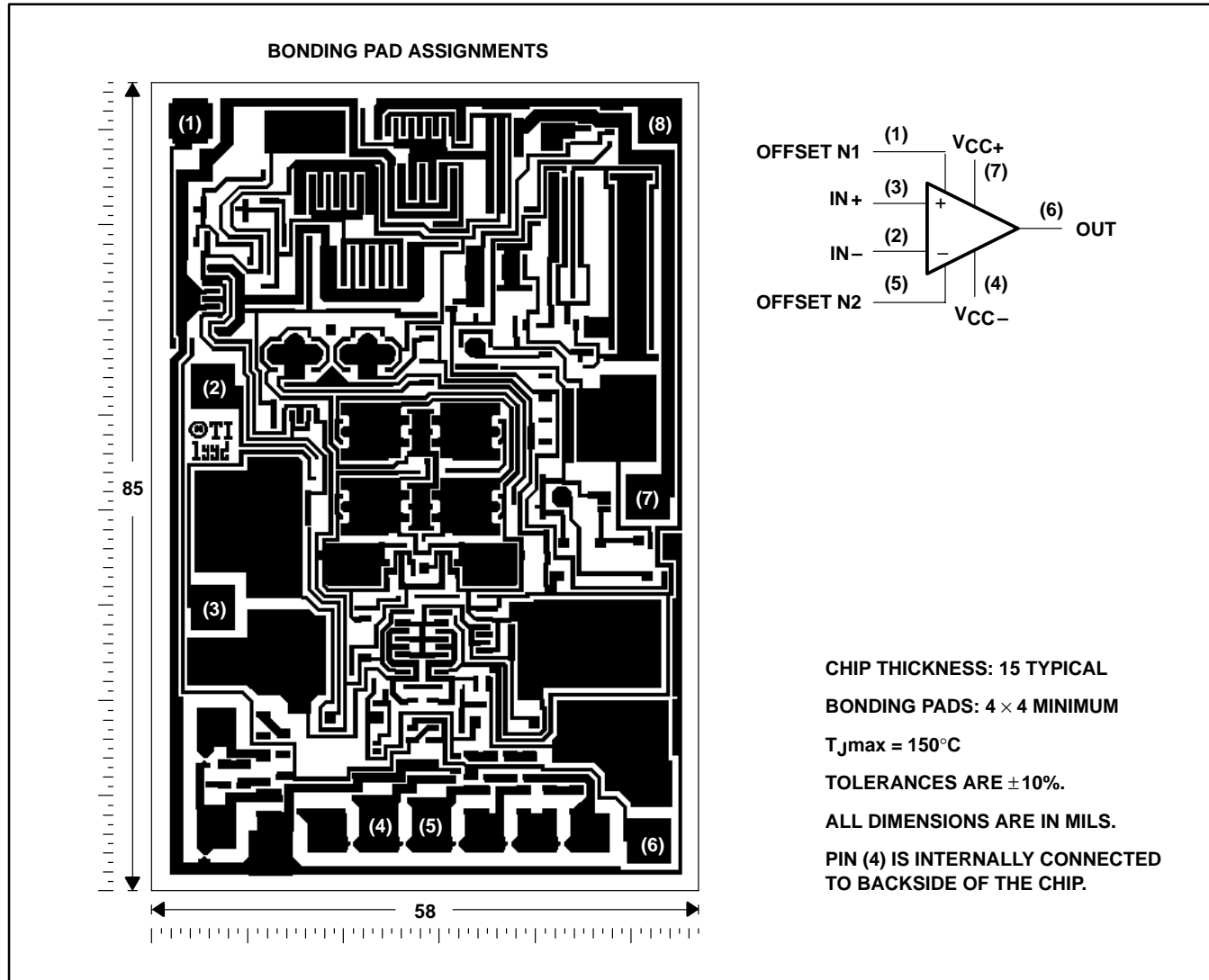

# TLE208x, TLE208xA, TLE208xY EXCALIBUR HIGH-SPEED JFET-INPUT OPERATIONAL AMPLIFIERS

SLOS182B – FEBRUARY 1997 – REVISED JUNE 2001

## TLE2082Y chip information

This chip, when properly assembled, displays characteristics similar to the TLE2082. Thermal compression or ultrasonic bonding may be used on the doped-aluminum bonding pads. Chips may be mounted with conductive epoxy or a gold-silicon preform.

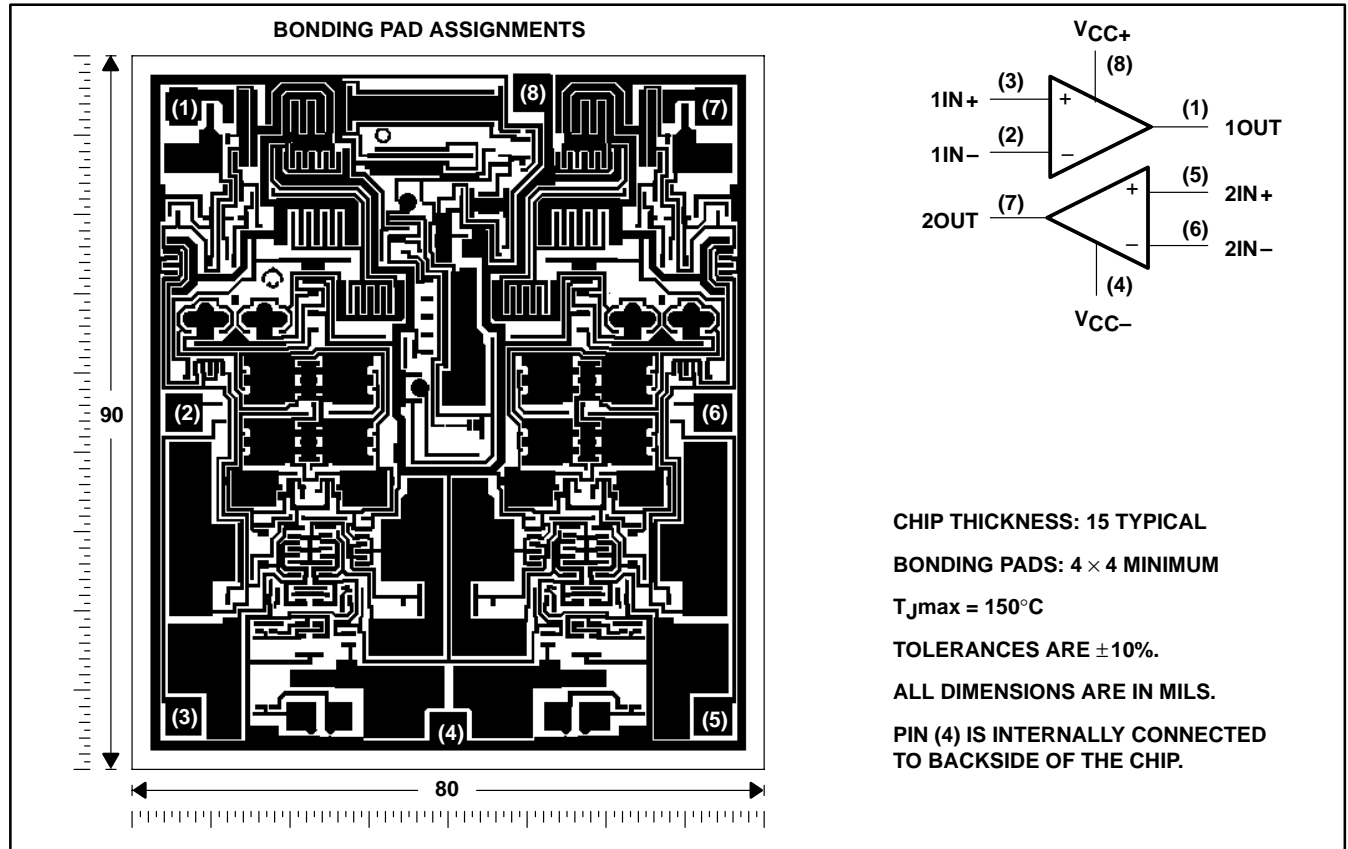

# TLE208x, TLE208xA, TLE208xY EXCALIBUR HIGH-SPEED JFET-INPUT OPERATIONAL AMPLIFIERS

SLOS182B – FEBRUARY 1997 – REVISED JUNE 2001

## TLE2084Y chip information

This chip, when properly assembled, displays characteristics similar to the TLE2084. Thermal compression or ultrasonic bonding may be used on the doped-aluminum bonding pads. Chips may be mounted with conductive epoxy or a gold-silicon preform.

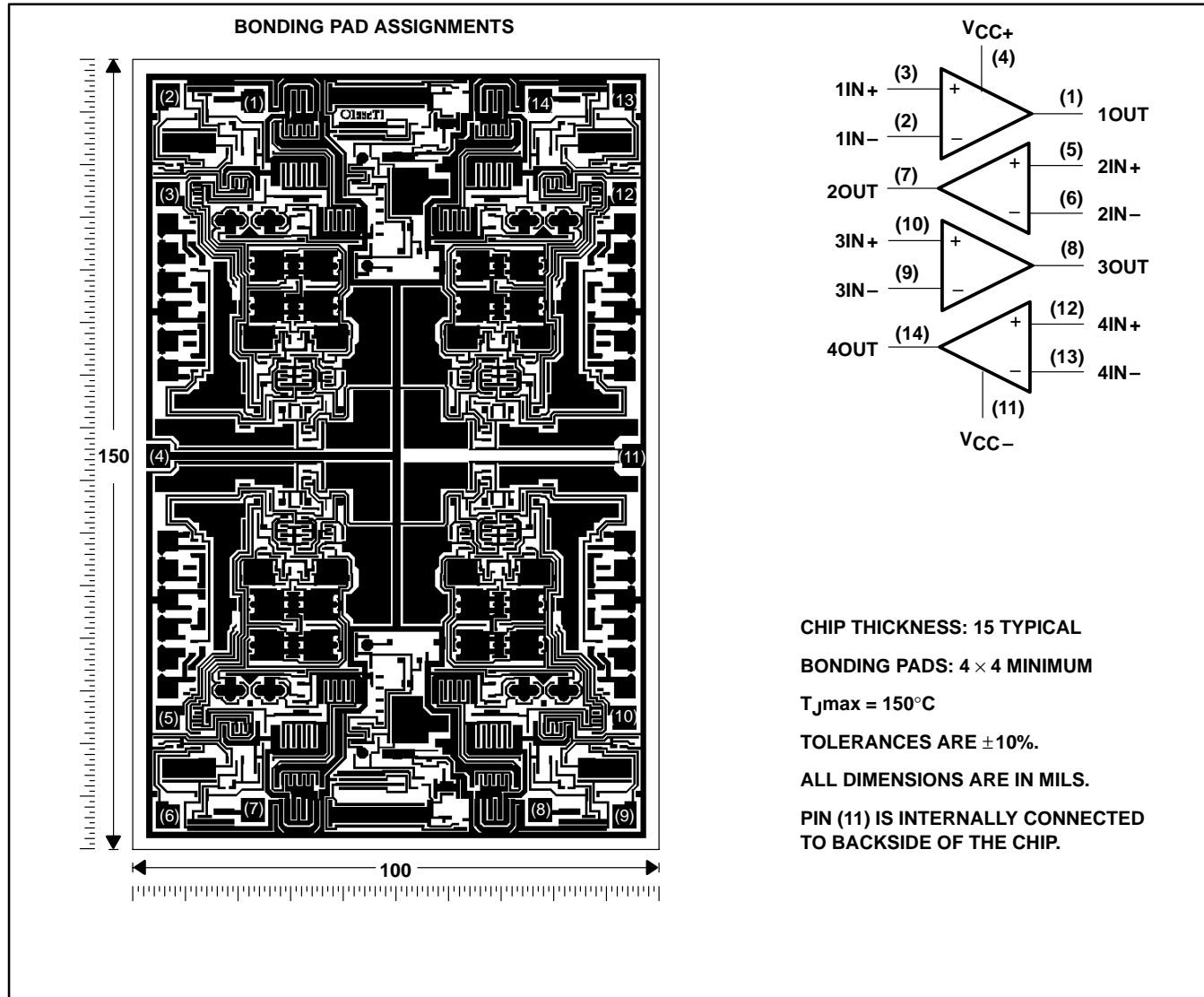

equivalent schematic (each channel)

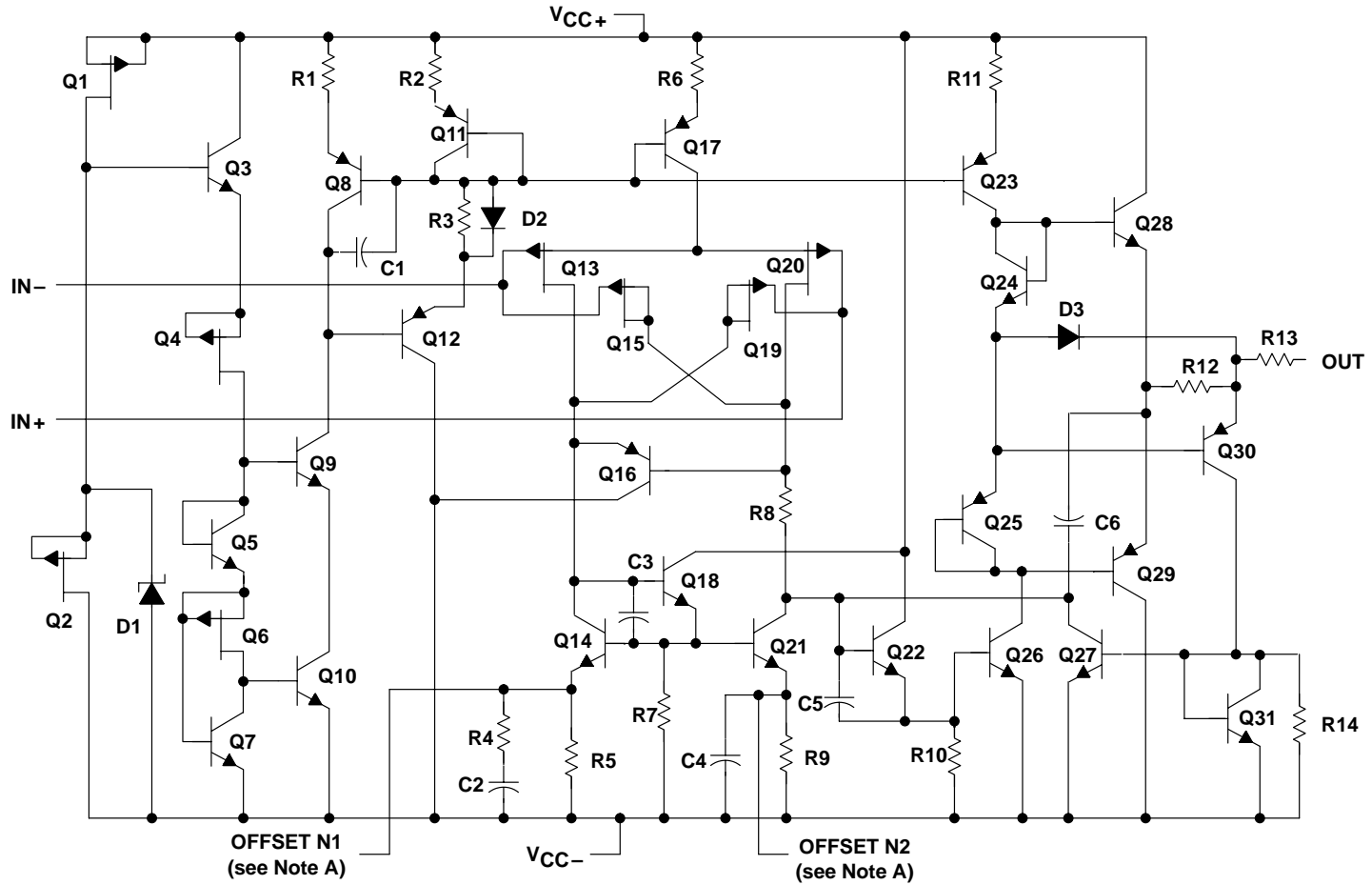

NOTE A: OFFSET N1 and OFFSET N2 are only available on the TLE2081x devices.

ACTUAL DEVICE COMPONENT COUNT			
COMPONENT	TLE2081	TLE2082	TLE2084
Transistors	33	57	114
Resistors	25	37	74
Diodes	8	5	10
Capacitors	6	11	22

# TLE208x, TLE208xA, TLE208xY EXCALIBUR HIGH-SPEED JFET-INPUT OPERATIONAL AMPLIFIERS

SLOS182B – FEBRUARY 1997 – REVISED JUNE 2001

## absolute maximum ratings over operating free-air temperature range (unless otherwise noted)†

Supply voltage, $V_{CC+}$ (see Note 1)	19 V
Supply voltage, $V_{CC-}$ (see Note 1)	-19 V
Differential input voltage range, $V_{ID}$ (see Note 2)	$V_{CC+}$ to $V_{CC-}$
Input voltage range, $V_I$ (any input)	$V_{CC+}$ to $V_{CC-}$
Input current, $I_I$ (each input)	$\pm 1$ mA
Output current, $I_O$ (each output)	$\pm 80$ mA
Total current into $V_{CC+}$	160 mA
Total current out of $V_{CC-}$	160 mA
Duration of short-circuit current at (or below) 25°C (see Note 3)	unlimited
Continuous total dissipation	See Dissipation Rating Table
Operating free-air temperature range, $T_A$ : C suffix	0°C to 70°C
I suffix	-40°C to 85°C
M suffix	-55°C to 125°C
Storage temperature range	-65°C to 150°C
Case temperature for 60 seconds: FK package	260°C
Lead temperature 1,6 mm (1/16 inch) from case for 10 seconds: DW or N package	260°C
Lead temperature 1,6 mm (1/16 inch) from case for 60 seconds: J package	300°C

† Stresses beyond those listed under “absolute maximum ratings” may cause permanent damage to the device. These are stress ratings only, and functional operation of the device at these or any other conditions beyond those indicated under “recommended operating conditions” is not implied. Exposure to absolute-maximum-rated conditions for extended periods may affect device reliability.

- NOTES:
- All voltage values, except differential voltages, are with respect to the midpoint between  $V_{CC+}$  and  $V_{CC-}$ .
  - Differential voltages are at  $IN+$  with respect to  $IN-$ .
  - The output can be shorted to either supply. Temperatures and/or supply voltages must be limited to ensure that the maximum dissipation rate is not exceeded.

DISSIPATION RATING TABLE

PACKAGE	$T_A \leq 25^\circ\text{C}$	DERATING FACTOR ABOVE $T_A = 25^\circ\text{C}$	$T_A = 70^\circ\text{C}$	$T_A = 85^\circ\text{C}$	$T_A = 125^\circ\text{C}$
	POWER RATING		POWER RATING	POWER RATING	POWER RATING
D	725 mW	5.8 mW/°C	464 mW	377 mW	145 mW
DW	1025 mW	8.2 mW/°C	656 mW	533 mW	205 mW
FK	1375 mW	11.0 mW/°C	880 mW	715 mW	275 mW
J	1375 mW	11.0 mW/°C	880 mW	715 mW	275 mW
JG	1050 mW	8.4 mW/°C	672 mW	546 mW	210 mW
N	1150 mW	9.2 mW/°C	736 mW	598 mW	230 mW
P	1000 mW	8.0 mW/°C	640 mW	344 mW	200 mW

## recommended operating conditions

	C SUFFIX		I SUFFIX		M SUFFIX		UNIT
	MIN	MAX	MIN	MAX	MIN	MAX	
Supply voltage, $V_{CC\pm}$	$\pm 2.25$	$\pm 19$	$\pm 2.25$	$\pm 19$	$\pm 2.25$	$\pm 19$	V
Common-mode input voltage, $V_{IC}$	$V_{CC\pm} = \pm 5$ V		-0.9	5	-0.8	5	V
	$V_{CC\pm} = \pm 15$ V		-10.9	15	-10.8	15	
Operating free-air temperature, $T_A$	0	70	-40	85	-55	125	°C





**TLE208x, TLE208xA, TLE208xY**  
**EXCALIBUR HIGH-SPEED JFET-INPUT**  
**OPERATIONAL AMPLIFIERS**

SLOS182B – FEBRUARY 1997 – REVISED JUNE 2001

**TLE2081C electrical characteristics at specified free-air temperature,  $V_{CC\pm} = \pm 5$  V (unless otherwise noted)**

PARAMETER	TEST CONDITIONS	$T_A$ †	TLE2081C			TLE2081AC			UNIT
			MIN	TYP	MAX	MIN	TYP	MAX	
$V_{IO}$ Input offset voltage	$V_{IC} = 0,$ $R_S = 50 \Omega$	$V_O = 0,$	25°C	0.34	6	0.3	3	mV	
			Full range	8			5		
$\alpha V_{IO}$ Temperature coefficient of input offset voltage	$V_{IC} = 0,$ $R_S = 50 \Omega$	$V_O = 0,$	Full range	3.2	29	3.2	29	$\mu V/^\circ C$	
$I_{IO}$ Input offset current			$V_{IC} = 0,$ See Figure 4	$V_O = 0,$	25°C	5	100	5	100
	Full range	1.4			1.4				
$I_{IB}$ Input bias current	$V_{IC} = 0,$ See Figure 4	$V_O = 0,$	25°C	15	175	15	175	nA	
			Full range	5			5		
$V_{ICR}$ Common-mode input voltage range	$R_S = 50 \Omega$		25°C	5 to -1	5 to -1.9	5 to -1	5 to -1.9	V	
			Full range	5 to -0.9			5 to -0.9		
$V_{OM+}$ Maximum positive peak output voltage swing	$I_O = -200 \mu A$		25°C	3.8	4.1	3.8	4.1	V	
			Full range	3.7			3.7		
	$I_O = -2$ mA		25°C	3.5	3.9	3.5	3.9		
			Full range	3.4			3.4		
	$I_O = -20$ mA		25°C	1.5	2.3	1.5	2.3		
			Full range	1.5			1.5		
$V_{OM-}$ Maximum negative peak output voltage swing	$I_O = 200 \mu A$		25°C	-3.5	-4.2	-3.5	-4.2	V	
			Full range	-3.4			-3.4		
	$I_O = 2$ mA		25°C	-3.7	-4.1	-3.7	-4.1		
			Full range	-3.6			-3.6		
	$I_O = 20$ mA		25°C	-1.5	-2.4	-1.5	-2.4		
			Full range	-1.5			-1.5		
$A_{VD}$ Large-signal differential voltage amplification	$V_O = \pm 2.3$ V	$R_L = 600 \Omega$	25°C	80	91	80	91	dB	
			Full range	79			79		
		$R_L = 2$ k $\Omega$		25°C	90	100	90		100
				Full range	89				89
		$R_L = 10$ k $\Omega$		25°C	95	106	95		106
				Full range	94				94
$r_i$ Input resistance	$V_{IC} = 0$		25°C	$10^{12}$		$10^{12}$		$\Omega$	
$c_i$ Input capacitance	$V_{IC} = 0,$ See Figure 5	Common mode	25°C	11		11		pF	
		Differential	25°C	2.5		2.5			
$z_o$ Open-loop output impedance	$f = 1$ MHz		25°C	80		80		$\Omega$	
CMRR Common-mode rejection ratio	$V_{IC} = V_{ICRmin},$ $V_O = 0,$ $R_S = 50 \Omega$		25°C	70	89	70	89	dB	
			Full range	68			68		
$k_{SVR}$ Supply-voltage rejection ratio ( $\Delta V_{CC\pm} / \Delta V_{IO}$ )	$V_{CC\pm} = \pm 5$ V to $\pm 15$ V, $V_O = 0,$ $R_S = 50 \Omega$		25°C	82	99	82	99	dB	
			Full range	80			80		

† Full range is 0°C to 70°C.



**TLE208x, TLE208xA, TLE208xY**  
**EXCALIBUR HIGH-SPEED JFET-INPUT**  
**OPERATIONAL AMPLIFIERS**

SLOS182B – FEBRUARY 1997 – REVISED JUNE 2001

**TLE2081C electrical characteristics at specified free-air temperature,  $V_{CC\pm} = \pm 5\text{ V}$  (unless otherwise noted) (continued)**

PARAMETER	TEST CONDITIONS	$T_A$ †	TLE2081C			TLE2081AC			UNIT
			MIN	TYP	MAX	MIN	TYP	MAX	
$I_{CC}$ Supply current	$V_O = 0$ , No load	25°C	1.35	1.6	2.2	1.35	1.6	2.2	mA
		Full range				2.2			
$I_{OS}$ Short-circuit output current	$V_O = 0$	25°C	$V_{ID} = 1\text{ V}$			$-35$			mA
			$V_{ID} = -1\text{ V}$			45			

† Full range is 0°C to 70°C.

**TLE2081C operating characteristics at specified free-air temperature,  $V_{CC\pm} = \pm 5\text{ V}$**

PARAMETER	TEST CONDITIONS	$T_A$ †	TLE2081C			TLE2081AC			UNIT
			MIN	TYP	MAX	MIN	TYP	MAX	
SR+ Positive slew rate	$V_{O(PP)} = \pm 2.3\text{ V}$ , $A_{VD} = -1$ , $R_L = 2\text{ k}\Omega$ , $C_L = 100\text{ pF}$ , See Figure 1	25°C	35			35			V/ $\mu$ s
		Full range	23			23			
SR- Negative slew rate		25°C	38			38			V/ $\mu$ s
		Full range	23			23			
$t_s$ Settling time	$A_{VD} = -1$ , 2-V step, $R_L = 1\text{ k}\Omega$ , $C_L = 100\text{ pF}$	25°C	To 10 mV			0.25			$\mu$ s
			To 1 mV			0.4			
$V_n$ Equivalent input noise voltage	$R_S = 20\ \Omega$ , See Figure 3	25°C	f = 10 Hz			28			nV/ $\sqrt{\text{Hz}}$
			f = 10 kHz			11.6			
$V_{N(PP)}$ Peak-to-peak equivalent input noise voltage		25°C	f = 10 Hz to 10 kHz			6			$\mu$ V
			f = 0.1 Hz to 10 Hz			0.6			
$I_n$ Equivalent input noise current	$V_{IC} = 0$ , f = 10 kHz	25°C	2.8			2.8			fA/ $\sqrt{\text{Hz}}$
THD + N Total harmonic distortion plus noise	$V_{O(PP)} = 5\text{ V}$ , $A_{VD} = 10$ , f = 1 kHz, $R_L = 2\text{ k}\Omega$ , $R_S = 25\ \Omega$	25°C	0.013%			0.013%			
$B_1$ Unity-gain bandwidth	$V_I = 10\text{ mV}$ , $R_L = 2\text{ k}\Omega$ , $C_L = 25\text{ pF}$ , See Figure 2	25°C	9.4			9.4			MHz
$B_{OM}$ Maximum output-swing bandwidth	$V_{O(PP)} = 4\text{ V}$ , $A_{VD} = -1$ , $R_L = 2\text{ k}\Omega$ , $C_L = 25\text{ pF}$	25°C	2.8			2.8			MHz
$\phi_m$ Phase margin at unity gain	$V_I = 10\text{ mV}$ , $R_L = 2\text{ k}\Omega$ , $C_L = 25\text{ pF}$ , See Figure 2	25°C	56°			56°			

† Full range is 0°C to 70°C.



**TLE208x, TLE208xA, TLE208xY**  
**EXCALIBUR HIGH-SPEED JFET-INPUT**  
**OPERATIONAL AMPLIFIERS**

SLOS182B – FEBRUARY 1997 – REVISED JUNE 2001

**TLE2081C electrical characteristics at specified free-air temperature,  $V_{CC\pm} = \pm 15$  V (unless otherwise noted)**

PARAMETER	TEST CONDITIONS	$T_A$ †	TLE2081C			TLE2081AC			UNIT	
			MIN	TYP	MAX	MIN	TYP	MAX		
$V_{IO}$ Input offset voltage	$V_{IC} = 0, V_O = 0, R_S = 50 \Omega$	25°C	0.49	6		0.47	3	mV		
		Full range			8		5			
$\alpha_{VIO}$ Temperature coefficient of input offset voltage		Full range	3.2	29		3.2	29	$\mu V/^\circ C$		
$I_{IO}$ Input offset current	$V_{IC} = 0, V_O = 0, \text{See Figure 4}$	25°C	6	100		6	100	nA		
		Full range		1.4			1.4			
$I_{IB}$ Input bias current		25°C	20	175		20	175	nA		
		Full range		5			5			
$V_{ICR}$ Common-mode input voltage range	$R_S = 50 \Omega$	25°C	15 to -11	15 to -11.9		15 to -11	15 to -11.9	V		
		Full range	15 to -10.9			15 to -10.9				
$V_{OM+}$ Maximum positive peak output voltage swing	$I_O = -200 \mu A$	25°C	13.8	14.1		13.8	14.1	V		
		Full range	13.7			13.7				
	$I_O = -2 \text{ mA}$	25°C	13.5	13.9		13.5	13.9			
		Full range	13.4			13.4				
	$I_O = -20 \text{ mA}$	25°C	11.5	12.3		11.5	12.3			
		Full range	11.5			11.5				
$V_{OM-}$ Maximum negative peak output voltage swing	$I_O = 200 \mu A$	25°C	-13.8	-14.2		-13.8	-14.2	V		
		Full range	-13.7			-13.7				
	$I_O = 2 \text{ mA}$	25°C	-13.5	-14		-13.5	-14			
		Full range	-13.4			-13.4				
	$I_O = 20 \text{ mA}$	25°C	-11.5	-12.4		-11.5	-12.4			
		Full range	-11.5			-11.5				
$A_{VD}$ Large-signal differential voltage amplification	$V_O = \pm 10 \text{ V}$	$R_L = 600 \Omega$	25°C	80	96		80	96	dB	
			Full range	79			79			
		$R_L = 2 \text{ k}\Omega$	25°C	90	109		90	109		
			Full range	89			89			
		$R_L = 10 \text{ k}\Omega$	25°C	95	118		95	118		
			Full range	94			94			
$r_i$ Input resistance	$V_{IC} = 0$	25°C	$10^{12}$			$10^{12}$			$\Omega$	
$c_i$ Input capacitance	$V_{IC} = 0, \text{See Figure 5}$	Common mode	25°C	7.5			7.5			pF
		Differential	25°C	2.5			2.5			
$z_o$ Open-loop output impedance	$f = 1 \text{ MHz}$	25°C	80			80			$\Omega$	
CMRR Common-mode rejection ratio	$V_{IC} = V_{ICRmin}, V_O = 0, R_S = 50 \Omega$	25°C	80	98		80	98	dB		
		Full range	79			79				
$k_{SVR}$ Supply-voltage rejection ratio ( $\Delta V_{CC\pm} / \Delta V_{IO}$ )	$V_{CC\pm} = \pm 5 \text{ V to } \pm 15 \text{ V}, V_O = 0, R_S = 50 \Omega$	25°C	82	99		82	99	dB		
		Full range	80			81				

† Full range is 0°C to 70°C.



**TLE208x, TLE208xA, TLE208xY**  
**EXCALIBUR HIGH-SPEED JFET-INPUT**  
**OPERATIONAL AMPLIFIERS**

SLOS182B – FEBRUARY 1997 – REVISED JUNE 2001

**TLE2081C electrical characteristics at specified free-air temperature,  $V_{CC\pm} = \pm 15\text{ V}$  (unless otherwise noted) (continued)**

PARAMETER	TEST CONDITIONS	$T_A$ †	TLE2081C			TLE2081AC			UNIT
			MIN	TYP	MAX	MIN	TYP	MAX	
$I_{CC}$ Supply current	$V_O = 0$ , No load	25°C	1.35	1.7	2.2	1.35	1.7	2.2	mA
		Full range	2.2			2.2			
$I_{OS}$ Short-circuit output current	$V_O = 0$	25°C	$V_{ID} = 1\text{ V}$	-30	-45	-30	-45	mA	
			$V_{ID} = -1\text{ V}$	30	48	30	48		

† Full range is 0°C to 70°C.

**TLE2081C operating characteristics at specified free-air temperature,  $V_{CC\pm} = \pm 15\text{ V}$**

PARAMETER	TEST CONDITIONS	$T_A$ †	TLE2081C			TLE2081AC			UNIT	
			MIN	TYP	MAX	MIN	TYP	MAX		
SR+ Positive slew rate	$V_{O(PP)} = 10\text{ V}$ , $A_{VD} = -1$ , $R_L = 2\text{ k}\Omega$ , $C_L = 100\text{ pF}$ , See Figure 1	25°C	30	40		30	40	V/ $\mu$ s		
		Full range	27			27				
SR- Negative slew rate		25°C	30	45		30	45	V/ $\mu$ s		
		Full range	27			27				
$t_s$ Settling time	$A_{VD} = -1$ , 10-V step, $R_L = 1\text{ k}\Omega$ , $C_L = 100\text{ pF}$	25°C	To 10 mV	0.4			0.4			$\mu$ s
			To 1 mV	1.5			1.5			
$V_n$ Equivalent input noise voltage	$R_S = 20\ \Omega$ , See Figure 3	25°C	f = 10 Hz	28			28			nV/ $\sqrt{\text{Hz}}$
			f = 10 kHz	11.6			11.6			
$V_{N(PP)}$ Peak-to-peak equivalent input noise voltage		25°C	f = 10 Hz to 10 kHz	6			6			$\mu$ V
			f = 0.1 Hz to 10 Hz	0.6			0.6			
$I_n$ Equivalent input noise current	$V_{IC} = 0$ , f = 10 kHz	25°C	2.8			2.8			fA/ $\sqrt{\text{Hz}}$	
THD + N Total harmonic distortion plus noise	$V_{O(PP)} = 20\text{ V}$ , $A_{VD} = 10$ , f = 1 kHz, $R_L = 2\text{ k}\Omega$ , $R_S = 25\ \Omega$	25°C	0.008%			0.008%				
$B_1$ Unity-gain bandwidth	$V_I = 10\text{ mV}$ , $R_L = 2\text{ k}\Omega$ , $C_L = 25\text{ pF}$ , See Figure 2	25°C	8	10		8	10	MHz		
$B_{OM}$ Maximum output-swing bandwidth	$V_{O(PP)} = 20\text{ V}$ , $A_{VD} = -1$ , $R_L = 2\text{ k}\Omega$ , $C_L = 25\text{ pF}$	25°C	478	637		478	637	kHz		
$\phi_m$ Phase margin at unity gain	$V_I = 10\text{ mV}$ , $R_L = 2\text{ k}\Omega$ , $C_L = 25\text{ pF}$ , See Figure 2	25°C	57°			57°				

† Full range is 0°C to 70°C.



**TLE208x, TLE208xA, TLE208xY**  
**EXCALIBUR HIGH-SPEED JFET-INPUT**  
**OPERATIONAL AMPLIFIERS**

SLOS182B – FEBRUARY 1997 – REVISED JUNE 2001

**TLE2081I electrical characteristics at specified free-air temperature,  $V_{CC\pm} = \pm 5\text{ V}$  (unless otherwise noted)**

PARAMETER	TEST CONDITIONS	$T_A$ †	TLE2081I			TLE2081AI			UNIT	
			MIN	TYP	MAX	MIN	TYP	MAX		
$V_{IO}$ Input offset voltage	$V_{IC} = 0,$ $R_S = 50\ \Omega,$ $V_O = 0,$	25°C	0.34		6	0.3		3	mV	
		Full range			7.6			5.6		
$\alpha_{VIO}$ Temperature coefficient of input offset voltage		Full range	3.2		29	3.2		29	$\mu\text{V}/^\circ\text{C}$	
$I_{IO}$ Input offset current	$V_{IC} = 0,$ $V_O = 0,$ See Figure 4	25°C	5		100	5		100	pA	
		Full range			5			5	nA	
$I_{IB}$ Input bias current		25°C	15		175	15		175	pA	
		Full range			10			10	nA	
$V_{ICR}$ Common-mode input voltage range	$R_S = 50\ \Omega$	25°C	5 to -1	5 to -1.9		5 to -1	5 to -1.9		V	
		Full range	5 to -0.8			5 to -0.8				
$V_{OM+}$ Maximum positive peak output voltage swing	$I_O = -200\ \mu\text{A}$	25°C	3.8		4.1	3.8		4.1	V	
		Full range			3.7			3.7		
	$I_O = -2\ \text{mA}$	25°C	3.5		3.9	3.5		3.9		
		Full range			3.4			3.4		
	$I_O = -20\ \text{mA}$	25°C	1.5		2.3	1.5		2.3		
		Full range			1.5			1.5		
$V_{OM-}$ Maximum negative peak output voltage swing	$I_O = 200\ \mu\text{A}$	25°C	-3.8		-4.2	-3.8		-4.2	V	
		Full range			-3.7			-3.7		
	$I_O = 2\ \text{mA}$	25°C	-3.5		-4.1	-3.5		-4.1		
		Full range			-3.4			-3.4		
	$I_O = 20\ \text{mA}$	25°C	-1.5		-2.4	-1.5		-2.4		
		Full range			-1.5			-1.5		
$A_{VD}$ Large-signal differential voltage amplification	$V_O = \pm 2.3\ \text{V}$	$R_L = 600\ \Omega$	25°C	80		91	80		91	dB
			Full range			79			79	
		$R_L = 2\ \text{k}\Omega$	25°C	90		100	90		100	
			Full range			89			89	
		$R_L = 10\ \text{k}\Omega$	25°C	95		106	95		106	
			Full range			94			94	
$r_i$ Input resistance	$V_{IC} = 0$	25°C	$10^{12}$			$10^{12}$			$\Omega$	
$c_i$ Input capacitance	$V_{IC} = 0,$ See Figure 5	Common mode	25°C	11			11			pF
		Differential	25°C	2.5			2.5			
$z_o$ Open-loop output impedance	$f = 1\ \text{MHz}$	25°C	80			80			$\Omega$	
CMRR Common-mode rejection ratio	$V_{IC} = V_{ICRmin},$ $V_O = 0,$ $R_S = 50\ \Omega$	25°C	70		89	70		89	dB	
		Full range			68			68		
$k_{SVR}$ Supply-voltage rejection ratio ( $\Delta V_{CC\pm}/\Delta V_{IO}$ )	$V_{CC\pm} = \pm 5\ \text{V}$ to $\pm 15\ \text{V},$ $V_O = 0,$ $R_S = 50\ \Omega$	25°C	82		99	82		99	dB	
		Full range			80			80		

† Full range is  $-40^\circ\text{C}$  to  $85^\circ\text{C}$ .



**TLE208x, TLE208xA, TLE208xY**  
**EXCALIBUR HIGH-SPEED JFET-INPUT**  
**OPERATIONAL AMPLIFIERS**

SLOS182B – FEBRUARY 1997 – REVISED JUNE 2001

**TLE2081I electrical characteristics at specified free-air temperature,  $V_{CC\pm} = \pm 5\text{ V}$  (unless otherwise noted) (continued)**

PARAMETER	TEST CONDITIONS	$T_A$ †	TLE2081I			TLE2081AI			UNIT
			MIN	TYP	MAX	MIN	TYP	MAX	
$I_{CC}$ Supply current	$V_O = 0$ , No load	25°C	1.35	1.6	2.2	1.35	1.6	2.2	mA
		Full range	2.2			2.2			
$I_{OS}$ Short-circuit output current	$V_O = 0$	$V_{ID} = 1\text{ V}$	-35			-35			mA
		$V_{ID} = -1\text{ V}$	45			45			

† Full range is  $-40^\circ\text{C}$  to  $85^\circ\text{C}$ .

**TLE2081I operating characteristics at specified free-air temperature,  $V_{CC\pm} = \pm 5\text{ V}$**

PARAMETER	TEST CONDITIONS	$T_A$ †	TLE2081I			TLE2081AI			UNIT
			MIN	TYP	MAX	MIN	TYP	MAX	
SR+ Positive slew rate	$V_{O(PP)} = \pm 2.3\text{ V}$ , $A_{VD} = -1$ , $R_L = 2\text{ k}\Omega$ , $C_L = 100\text{ pF}$ , See Figure 1	25°C	35			35			V/ $\mu\text{s}$
		Full range	22			22			
SR- Negative slew rate		25°C	38			38			V/ $\mu\text{s}$
		Full range	22			22			
$t_s$ Settling time	$A_{VD} = -1$ , 2-V step, $R_L = 1\text{ k}\Omega$ , $C_L = 100\text{ pF}$	To 10 mV	0.25			0.25			$\mu\text{s}$
		To 1 mV	0.4			0.4			
$V_n$ Equivalent input noise voltage	$R_S = 20\ \Omega$ , See Figure 3	f = 10 Hz	28			28			nV/ $\sqrt{\text{Hz}}$
		f = 10 kHz	11.6			11.6			
$V_{N(PP)}$ Peak-to-peak equivalent input noise voltage		f = 10 Hz to 10 kHz	6			6			$\mu\text{V}$
		f = 0.1 Hz to 10 Hz	0.6			0.6			
$I_n$ Equivalent input noise current	$V_{IC} = 0$ , f = 10 kHz	25°C	2.8			2.8			fA/ $\sqrt{\text{Hz}}$
THD + N Total harmonic distortion plus noise	$V_{O(PP)} = 5\text{ V}$ , $A_{VD} = 10$ , f = 1 kHz, $R_L = 2\text{ k}\Omega$ , $R_S = 25\ \Omega$	25°C	0.013%			0.013%			
$B_1$ Unity-gain bandwidth	$V_I = 10\text{ mV}$ , $R_L = 2\text{ k}\Omega$ , $C_L = 25\text{ pF}$ , See Figure 2	25°C	9.4			9.4			MHz
$B_{OM}$ Maximum output-swing bandwidth	$V_{O(PP)} = 4\text{ V}$ , $A_{VD} = -1$ , $R_L = 2\text{ k}\Omega$ , $C_L = 25\text{ pF}$	25°C	2.8			2.8			MHz
$\phi_m$ Phase margin at unity gain	$V_I = 10\text{ mV}$ , $R_L = 2\text{ k}\Omega$ , $C_L = 25\text{ pF}$ , See Figure 2	25°C	56°			56°			

† Full range is  $-40^\circ\text{C}$  to  $85^\circ\text{C}$ .



**TLE208x, TLE208xA, TLE208xY**  
**EXCALIBUR HIGH-SPEED JFET-INPUT**  
**OPERATIONAL AMPLIFIERS**

SLOS182B – FEBRUARY 1997 – REVISED JUNE 2001

**TLE20811 electrical characteristics at specified free-air temperature,  $V_{CC\pm} = \pm 15$  V (unless otherwise noted)**

PARAMETER	TEST CONDITIONS	$T_A$ †	TLE20811			TLE2081AI			UNIT	
			MIN	TYP	MAX	MIN	TYP	MAX		
$V_{IO}$ Input offset voltage	$V_{IC} = 0,$ $R_S = 50 \Omega,$ $V_O = 0,$	25°C	0.49	6		0.47	3	mV		
		Full range			7.6		5.6			
$\alpha V_{IO}$ Temperature coefficient of input offset voltage		Full range	3.2	29		3.2	29	$\mu V/^\circ C$		
$I_{IO}$ Input offset current	$V_{IC} = 0,$ $V_O = 0,$ See Figure 4	25°C	6	100		6	100	pA		
		Full range		5			5	nA		
$I_{IB}$ Input bias current		25°C	20	175		20	175	pA		
		Full range		10			10	nA		
$V_{ICR}$ Common-mode input voltage range	$R_S = 50 \Omega$	25°C	15 to -11	15 to -11.9		15 to -11	15 to -11.9	V		
		Full range	15 to -10.8			15 to -10.8				
$V_{OM+}$ Maximum positive peak output voltage swing	$I_O = -200 \mu A$	25°C	13.8	14.1		13.8	14.1	V		
		Full range	13.7			13.7				
	$I_O = -2$ mA	25°C	13.5	13.9		13.5	13.9			
		Full range	13.4			13.4				
	$I_O = -20$ mA	25°C	11.5	12.3		11.5	12.3			
		Full range	11.5			11.5				
$V_{OM-}$ Maximum negative peak output voltage swing	$I_O = 200 \mu A$	25°C	-13.8	-14.2		-13.8	-14.2	V		
		Full range	-13.7			-13.7				
	$I_O = 2$ mA	25°C	-13.5	-14		-13.5	-14			
		Full range	-13.4			-13.4				
	$I_O = 20$ mA	25°C	-11.5	-12.4		-11.5	-12.4			
		Full range	-11.5			-11.5				
$A_{VD}$ Large-signal differential voltage amplification	$V_O = \pm 10$ V	$R_L = 600 \Omega$	25°C	80	96		80	96	dB	
			Full range	79			79			
		$R_L = 2$ k $\Omega$	25°C	90	109		90	109		
			Full range	89			89			
		$R_L = 10$ k $\Omega$	25°C	95	118		95	118		
			Full range	94			94			
$r_i$ Input resistance	$V_{IC} = 0$	25°C	$10^{12}$			$10^{12}$			$\Omega$	
$c_i$ Input capacitance	$V_{IC} = 0,$ See Figure 5	Common mode	25°C	7.5			7.5			pF
		Differential	25°C	2.5			2.5			
$z_o$ Open-loop output impedance	$f = 1$ MHz	25°C	80			80			$\Omega$	
CMRR Common-mode rejection ratio	$V_{IC} = V_{ICRmin},$ $V_O = 0,$ $R_S = 50 \Omega$	25°C	80	98		80	98	dB		
		Full range	79			79				
$k_{SVR}$ Supply-voltage rejection ratio ( $\Delta V_{CC\pm}/\Delta V_{IO}$ )	$V_{CC\pm} = \pm 5$ V to $\pm 15$ V, $V_O = 0,$ $R_S = 50 \Omega$	25°C	82	99		82	99	dB		
		Full range	80			80				

† Full range is  $-40^\circ C$  to  $85^\circ C$ .



**TLE208x, TLE208xA, TLE208xY**  
**EXCALIBUR HIGH-SPEED JFET-INPUT**  
**OPERATIONAL AMPLIFIERS**

SLOS182B – FEBRUARY 1997 – REVISED JUNE 2001

**TLE2081I electrical characteristics at specified free-air temperature,  $V_{CC\pm} = \pm 15\text{ V}$  (unless otherwise noted) (continued)**

PARAMETER	TEST CONDITIONS	$T_A$ †	TLE2081I			TLE2081AI			UNIT
			MIN	TYP	MAX	MIN	TYP	MAX	
$I_{CC}$ Supply current	$V_O = 0$ , No load	25°C	1.35	1.7	2.2	1.35	1.7	2.2	mA
		Full range	2.2			2.2			
$I_{OS}$ Short-circuit output current	$V_O = 0$	25°C	$V_{ID} = 1\text{ V}$		-30 -45		-30 -45		mA
			$V_{ID} = -1\text{ V}$		30 48		30 48		

† Full range is  $-40^\circ\text{C}$  to  $85^\circ\text{C}$ .

**TLE2081I operating characteristics at specified free-air temperature,  $V_{CC\pm} = \pm 15\text{ V}$**

PARAMETER	TEST CONDITIONS	$T_A$ †	TLE2081I			TLE2081AI			UNIT
			MIN	TYP	MAX	MIN	TYP	MAX	
SR+ Positive slew rate	$V_{O(PP)} = \pm 10\text{ V}$ , $A_{VD} = -1$ , $C_L = 100\text{ pF}$ , $R_L = 2\text{ k}\Omega$ , See Figure 1	25°C	30	40		30	40		V/ $\mu\text{s}$
		Full range	24			24			
SR- Negative slew rate		25°C	30	45		30	45		V/ $\mu\text{s}$
		Full range	24			24			
$t_s$ Settling time	$A_{VD} = -1$ , 10-V step, $R_L = 1\text{ k}\Omega$ , $C_L = 100\text{ pF}$	25°C	To 10 mV		0.4		0.4		$\mu\text{s}$
			To 1 mV		1.5		1.5		
$V_n$ Equivalent input noise voltage	$R_S = 20\ \Omega$ , See Figure 3	25°C	f = 10 Hz		28		28		nV/ $\sqrt{\text{Hz}}$
			f = 10 kHz		11.6		11.6		
$V_{N(PP)}$ Peak-to-peak equivalent input noise voltage		25°C	f = 10 Hz to 10 kHz		6		6		$\mu\text{V}$
			f = 0.1 Hz to 10 Hz		0.6		0.6		
$I_n$ Equivalent input noise current	$V_{IC} = 0$ , f = 10 kHz	25°C	2.8			2.8			fA/ $\sqrt{\text{Hz}}$
THD + N Total harmonic distortion plus noise	$V_{O(PP)} = 20\text{ V}$ , $A_{VD} = 10$ , f = 1 kHz, $R_L = 2\text{ k}\Omega$ , $R_S = 25\ \Omega$	25°C	0.008%			0.008%			
$B_1$ Unity-gain bandwidth	$V_I = 10\text{ mV}$ , $R_L = 2\text{ k}\Omega$ , $C_L = 25\text{ pF}$ , See Figure 2	25°C	8	10		8	10	MHz	
BOM Maximum output-swing bandwidth	$V_{O(PP)} = 20\text{ V}$ , $A_{VD} = -1$ , $R_L = 2\text{ k}\Omega$ , $C_L = 25\text{ pF}$	25°C	478	637		478	637	kHz	
$\phi_m$ Phase margin at unity gain	$V_I = 10\text{ mV}$ , $R_L = 2\text{ k}\Omega$ , $C_L = 25\text{ pF}$ , See Figure 2	25°C	57°			57°			

† Full range is  $-40^\circ\text{C}$  to  $85^\circ\text{C}$ .





**TLE208x, TLE208xA, TLE208xY**  
**EXCALIBUR HIGH-SPEED JFET-INPUT**  
**OPERATIONAL AMPLIFIERS**

SLOS182B – FEBRUARY 1997 – REVISED JUNE 2001

**TLE2081M electrical characteristics at specified free-air temperature,  $V_{CC\pm} = \pm 5$  V (unless otherwise noted)**

PARAMETER	TEST CONDITIONS	$T_A$ †	TLE2081M			TLE2081AM			UNIT	
			MIN	TYP	MAX	MIN	TYP	MAX		
$V_{IO}$ Input offset voltage	$V_{IC} = 0,$ $V_O = 0,$ $R_S = 50\Omega$	25°C	0.34	6		0.3	3	mV		
		Full range			11.2		8.2			
$\alpha V_{IO}$ Temperature coefficient of input offset voltage		Full range	3.2	29*		3.2	29*	$\mu V/^\circ C$		
$I_{IO}$ Input offset current	$V_{IC} = 0,$ $V_O = 0,$ See Figure 4	25°C	5	100		5	100	pA		
		Full range			20		20	nA		
$I_{IB}$ Input bias current		25°C	15	175		15	175	pA		
		Full range			65		65	nA		
$V_{ICR}$ Common-mode input voltage range	$R_S = 50\Omega$	25°C	5 to -1	5 to -1.9		5 to -1	5 to -1.9	V		
		Full range	5 to -0.8			5 to -0.8				
$V_{OM+}$ Maximum positive peak output voltage swing	$I_O = -200\mu A$	25°C	3.8	4.1		3.8	4.1	V		
		Full range	3.6			3.6				
	$I_O = -2$ mA	25°C	3.5	3.9		3.5	3.9			
		Full range	3.3			3.3				
	$I_O = -20$ mA	25°C	1.5	2.3		1.5	2.3			
		Full range	1.4			1.4				
$V_{OM-}$ Maximum negative peak output voltage swing	$I_O = 200\mu A$	25°C	-3.8	-4.2		-3.8	-4.2	V		
		Full range	-3.6			-3.6				
	$I_O = 2$ mA	25°C	-3.5	-4.1		-3.5	-4.1			
		Full range	-3.3			-3.3				
	$I_O = 20$ mA	25°C	-1.5	-2.4		-1.5	-2.4			
		Full range	-1.4			-1.4				
$A_{VD}$ Large-signal differential voltage amplification	$V_O = \pm 2.3$ V	$R_L = 600\Omega$	25°C	80	91		80	91	dB	
			Full range	78			78			
		$R_L = 2$ k $\Omega$	25°C	90	100		90	100		
			Full range	88			88			
		$R_L = 10$ k $\Omega$	25°C	95	106		95	106		
			Full range	93			93			
$r_i$ Input resistance	$V_{IC} = 0$	25°C	$10^{12}$			$10^{12}$			$\Omega$	
$c_i$ Input capacitance	$V_{IC} = 0,$ See Figure 5	Common mode	25°C	11			11			pF
		Differential	25°C	2.5			2.5			
$z_o$ Open-loop output impedance	$f = 1$ MHz	25°C	80			80			$\Omega$	
CMRR Common-mode rejection ratio	$V_{IC} = V_{ICRmin},$ $V_O = 0,$ $R_S = 50\Omega$	25°C	70	89		70	89	dB		
		Full range	68			68				
$k_{SVR}$ Supply-voltage rejection ratio ( $\Delta V_{CC\pm}/\Delta V_{IO}$ )	$V_{CC\pm} = \pm 5$ V to $\pm 15$ V, $V_O = 0,$ $R_S = 50\Omega$	25°C	82	99		82	99	dB		
		Full range	80			80				

\*On products compliant with MIL-PRF-38535, Class B, this parameter is not production tested.

† Full range is  $-55^\circ C$  to  $125^\circ C$ .



**TLE208x, TLE208xA, TLE208xY**  
**EXCALIBUR HIGH-SPEED JFET-INPUT**  
**OPERATIONAL AMPLIFIERS**

SLOS182B – FEBRUARY 1997 – REVISED JUNE 2001

**TLE2081M electrical characteristics at specified free-air temperature,  $V_{CC\pm} = \pm 5\text{ V}$  (unless otherwise noted) (continued)**

PARAMETER	TEST CONDITIONS	$T_A$ †	TLE2081M			TLE2081AM			UNIT
			MIN	TYP	MAX	MIN	TYP	MAX	
$I_{CC}$ Supply current	$V_O = 0$ , No load	25°C	1.35	1.6	2.2	1.35	1.6	2.2	mA
		Full range	2.2			2.2			
$I_{OS}$ Short-circuit output current	$V_O = 0$	$V_{ID} = 1\text{ V}$	-35			-35			mA
		$V_{ID} = -1\text{ V}$	45			45			

† Full range is  $-55^\circ\text{C}$  to  $125^\circ\text{C}$ .

**TLE2081M operating characteristics at specified free-air temperature,  $V_{CC\pm} = \pm 5\text{ V}$**

PARAMETER	TEST CONDITIONS	$T_A$ †	TLE2081M			TLE2081AM			UNIT	
			MIN	TYP	MAX	MIN	TYP	MAX		
SR+ Positive slew rate	$V_{O(PP)} = \pm 2.3\text{ V}$ , $A_{VD} = -1$ , $R_L = 2\text{ k}\Omega$ , $C_L = 100\text{ pF}$ , See Figure 1	25°C	35			35			V/ $\mu\text{s}$	
		Full range	20*			20*				
SR- Negative slew rate		25°C	38			38			V/ $\mu\text{s}$	
		Full range	20*			20*				
$t_s$ Settling time	$A_{VD} = -1$ , 2-V step, $R_L = 1\text{ k}\Omega$ , $C_L = 100\text{ pF}$	To 10 mV	0.25			0.25			$\mu\text{s}$	
		To 1 mV	0.4			0.4				
$V_n$ Equivalent input noise voltage	$R_S = 20\ \Omega$ , See Figure 3	f = 10 Hz	28			28			nV/ $\sqrt{\text{Hz}}$	
		f = 10 kHz	11.6			11.6				
$V_{N(PP)}$ Peak-to-peak equivalent input noise voltage		f = 10 Hz to 10 kHz	6			6			$\mu\text{V}$	
		f = 0.1 Hz to 10 Hz	0.6			0.6				
$I_n$ Equivalent input noise current	$V_{IC} = 0$ , f = 10 kHz	25°C	2.8			2.8			fA/ $\sqrt{\text{Hz}}$	
THD + N Total harmonic distortion plus noise	$V_{O(PP)} = 5\text{ V}$ , f = 1 kHz, $R_S = 25\ \Omega$	$A_{VD} = 10$ , $R_L = 2\text{ k}\Omega$	25°C	0.013%			0.013%			
$B_1$ Unity-gain bandwidth	$V_I = 10\text{ mV}$ , $C_L = 25\text{ pF}$	$R_L = 2\text{ k}\Omega$ , See Figure 2	25°C	9.4			9.4			MHz
$B_{OM}$ Maximum output-swing bandwidth	$V_{O(PP)} = 4\text{ V}$ , $R_L = 2\text{ k}\Omega$	$A_{VD} = -1$ , $C_L = 25\text{ pF}$	25°C	2.8			2.8			MHz
$\phi_m$ Phase margin at unity gain	$V_I = 10\text{ mV}$ , $C_L = 25\text{ pF}$	$R_L = 2\text{ k}\Omega$ , See Figure 2	25°C	56°			56°			

\*On products compliant with MIL-PRF-38535, Class B, this parameter is not production tested.

† Full range is  $-55^\circ\text{C}$  to  $125^\circ\text{C}$ .



**TLE208x, TLE208xA, TLE208xY**  
**EXCALIBUR HIGH-SPEED JFET-INPUT**  
**OPERATIONAL AMPLIFIERS**

SLOS182B – FEBRUARY 1997 – REVISED JUNE 2001

**TLE2081M electrical characteristics at specified free-air temperature,  $V_{CC\pm} = \pm 15$  V (unless otherwise noted)**

PARAMETER	TEST CONDITIONS	$T_A$ †	TLE2081M			TLE2081AM			UNIT
			MIN	TYP	MAX	MIN	TYP	MAX	
$V_{IO}$ Input offset voltage	$V_{IC} = 0,$ $R_S = 50 \Omega$	$V_O = 0,$	25°C	0.49	6	0.47	3	mV	
			Full range	11.2			8.2		
$\alpha_{VIO}$ Temperature coefficient of input offset voltage			Full range	3.2	29*	3.2	29*	$\mu V/^\circ C$	
$I_{IO}$ Input offset current	$V_{IC} = 0,$ See Figure 4	$V_O = 0,$	25°C	6	100	6	100	pA	
			Full range	20			20		
$I_{IB}$ Input bias current			25°C	20	175	20	175	pA	
			Full range	65			65		
$V_{ICR}$ Common-mode input voltage range	$R_S = 50 \Omega$		25°C	15 to -11	15 to -11.9	15 to -11	15 to -11.9	V	
			Full range	15 to -10.8		15 to -10.8			
$V_{OM+}$ Maximum positive peak output voltage swing	$I_O = -200 \mu A$		25°C	13.8	14.1	13.8	14.1	V	
			Full range	13.6			13.6		
	$I_O = -2$ mA		25°C	13.5	13.9	13.5	13.9		
			Full range	13.3			13.3		
	$I_O = -20$ mA		25°C	11.5	12.3	11.5	12.3		
			Full range	11.4			11.4		
$V_{OM-}$ Maximum negative peak output voltage swing	$I_O = 200 \mu A$		25°C	-13.8	-14.2	-13.8	-14.2	V	
			Full range	-13.6			-13.6		
	$I_O = 2$ mA		25°C	-13.5	-14	-13.5	-14		
			Full range	-13.3			-13.3		
	$I_O = 20$ mA		25°C	-11.5	-12.4	-11.5	-12.4		
			Full range	-11.4			-11.4		
$A_{VD}$ Large-signal differential voltage amplification	$V_O = \pm 10$ V	$R_L = 600 \Omega$	25°C	80	96	80	96	dB	
			Full range	78			78		
		$R_L = 2$ k $\Omega$	25°C	90	109	90	109		
			Full range	88			88		
		$R_L = 10$ k $\Omega$	25°C	95	118	95	118		
			Full range	93			93		
$r_i$ Input resistance	$V_{IC} = 0$		25°C	$10^{12}$			$10^{12}$	$\Omega$	
$c_i$ Input capacitance	$V_{IC} = 0,$ See Figure 5	Common mode	25°C	7.5			7.5	pF	
		Differential	25°C	2.5			2.5		
$z_o$ Open-loop output impedance	$f = 1$ MHz		25°C	80			80	$\Omega$	
CMRR Common-mode rejection ratio	$V_{IC} = V_{ICRmin},$ $V_O = 0,$ $R_S = 50 \Omega$		25°C	80	98	80	98	dB	
			Full range	78			78		
$k_{SVR}$ Supply-voltage rejection ratio ( $\Delta V_{CC\pm} / \Delta V_{IO}$ )	$V_{CC\pm} = \pm 5$ V to $\pm 15$ V, $V_O = 0,$ $R_S = 50 \Omega$		25°C	82	99	82	99	dB	
			Full range	80			80		

\*On products compliant with MIL-PRF-38535, Class B, this parameter is not production tested.

† Full range is  $-55^\circ C$  to  $125^\circ C$ .



# TLE208x, TLE208xA, TLE208xY EXCALIBUR HIGH-SPEED JFET-INPUT OPERATIONAL AMPLIFIERS

SLOS182B – FEBRUARY 1997 – REVISED JUNE 2001

## TLE2081M electrical characteristics at specified free-air temperature, $V_{CC\pm} = \pm 15\text{ V}$ (unless otherwise noted)(continued)

PARAMETER	TEST CONDITIONS	$T_A$ †	TLE2081M			TLE2081AM			UNIT	
			MIN	TYP	MAX	MIN	TYP	MAX		
$I_{CC}$	Supply current	$V_O = 0$ , No load	25°C	1.35	1.7	2.2	1.35	1.7	2.2	mA
			Full range	2.2			2.2			
$I_{OS}$	Short-circuit output current	$V_O = 0$	25°C	$V_{ID} = 1\text{ V}$	-30	-45	-30	-45	mA	
				$V_{ID} = -1\text{ V}$	30	48	30	48		

† Full range is  $-55^\circ\text{C}$  to  $125^\circ\text{C}$ .

## TLE2081M operating characteristics at specified free-air temperature, $V_{CC\pm} = \pm 15\text{ V}$

PARAMETER	TEST CONDITIONS	$T_A$ †	TLE2081M			TLE2081AM			UNIT	
			MIN	TYP	MAX	MIN	TYP	MAX		
SR+	Positive slew rate	$V_{O(PP)} = 10\text{ V}$ , $A_{VD} = -1$ , $C_L = 100\text{ pF}$ , $R_L = 2\text{ k}\Omega$ , See Figure 1	25°C	30	40	30	40	$\text{V}/\mu\text{s}$		
			Full range	22			22			
SR-	Negative slew rate	$V_{O(PP)} = 10\text{ V}$ , $A_{VD} = -1$ , $C_L = 100\text{ pF}$ , $R_L = 2\text{ k}\Omega$ , See Figure 1	25°C	30	45	30	45	$\text{V}/\mu\text{s}$		
			Full range	22			22			
$t_s$	Settling time	$A_{VD} = -1$ , 10-V step, $R_L = 1\text{ k}\Omega$ , $C_L = 100\text{ pF}$	To 10 mV	0.4			0.4			$\mu\text{s}$
			To 1 mV	1.5			1.5			
$V_n$	Equivalent input noise voltage	$R_S = 20\ \Omega$ , See Figure 3	f = 10 Hz	28			28			$\text{nV}/\sqrt{\text{Hz}}$
			f = 10 kHz	11.6			11.6			
$V_{N(PP)}$	Peak-to-peak equivalent input noise voltage	$R_S = 20\ \Omega$ , See Figure 3	f = 10 Hz to 10 kHz	6			6			$\mu\text{V}$
			f = 0.1 Hz to 10 Hz	0.6			0.6			
$I_n$	Equivalent input noise current	$V_{IC} = 0$ , f = 10 kHz	25°C	2.8			2.8			$\text{fA}/\sqrt{\text{Hz}}$
THD + N	Total harmonic distortion plus noise	$V_{O(PP)} = 20\text{ V}$ , f = 1 kHz, $R_S = 25\ \Omega$	25°C	0.008%			0.008%			
$B_1$	Unity-gain bandwidth	$V_I = 10\text{ mV}$ , $C_L = 25\text{ pF}$ , $R_L = 2\text{ k}\Omega$ , See Figure 2	25°C	8*	10	8*	10	MHz		
BOM	Maximum output-swing bandwidth	$V_{O(PP)} = 20\text{ V}$ , $R_L = 2\text{ k}\Omega$ , $C_L = 25\text{ pF}$	25°C	478*	637	478*	637	kHz		
$\phi_m$	Phase margin at unity gain	$V_I = 10\text{ mV}$ , $C_L = 25\text{ pF}$ , $R_L = 2\text{ k}\Omega$ , See Figure 2	25°C	57°			57°			

\*On products compliant with MIL-PRF-38535, Class B, this parameter is not production tested.

† Full range is  $-55^\circ\text{C}$  to  $125^\circ\text{C}$ .



**TLE208x, TLE208xA, TLE208xY**  
**EXCALIBUR HIGH-SPEED JFET-INPUT**  
**OPERATIONAL AMPLIFIERS**

SLOS182B – FEBRUARY 1997 – REVISED JUNE 2001

**TLE2081Y electrical characteristics at  $V_{CC\pm} = \pm 15\text{ V}$ ,  $T_A = 25^\circ\text{C}$**

PARAMETER		TEST CONDITIONS		TLE2081Y			UNIT
				MIN	TYP	MAX	
$V_{IO}$	Input offset voltage	$V_{IC} = 0$ ,	$V_O = 0$ , $R_S = 50\ \Omega$	0.49	6		mV
$I_{IO}$	Input offset current	$V_{IC} = 0$ ,	$V_O = 0$ , See Figure 4	6	100		pA
$I_{IB}$	Input bias current			20	175		
$V_{ICR}$	Common-mode input voltage range	$R_S = 50\ \Omega$		15 to -11	15 to 11.9		V
$V_{OM+}$	Maximum positive peak output voltage swing	$I_O = -200\ \mu\text{A}$		13.8	14.1		V
		$I_O = -2\ \text{mA}$		13.5	13.9		
		$I_O = -20\ \text{mA}$		11.5	12.3		
$V_{OM-}$	Maximum negative peak output voltage swing	$I_O = 200\ \mu\text{A}$		-13.8	-14.2		V
		$I_O = 2\ \text{mA}$		-13.5	-14		
		$I_O = 20\ \text{mA}$		-11.5	-12.4		
$A_{VD}$	Large-signal differential voltage amplification	$V_O = \pm 10\ \text{V}$	$R_L = 600\ \Omega$	80	96		dB
			$R_L = 2\ \text{k}\Omega$	90	109		
			$R_L = 10\ \text{k}\Omega$	95	118		
$r_i$	Input resistance	$V_{IC} = 0$		10 <sup>12</sup>			$\Omega$
$c_i$	Input capacitance	$V_{IC} = 0$ , See Figure 5	Common mode	7.5			pF
			Differential	2.5			
$z_o$	Open-loop output impedance	$f = 1\ \text{MHz}$		80			$\Omega$
CMRR	Common-mode rejection ratio	$V_{IC} = V_{ICR\text{min}}$ ,	$V_O = 0$ , $R_S = 50\ \Omega$	80	98		dB
$k_{SVR}$	Supply-voltage rejection ratio ( $\Delta V_{CC\pm} / \Delta V_{IO}$ )	$V_{CC\pm} = \pm 5\ \text{V}$ to $\pm 15\ \text{V}$ , $V_O = 0$ , $R_S = 50\ \Omega$		82	99		dB
$I_{CC}$	Supply current	$V_O = 0$ ,	No load	1.35	1.7	2.2	mA
$I_{OS}$	Short-circuit output current	$V_O = 0$	$V_{ID} = 1\ \text{V}$	-30	-45		mA
			$V_{ID} = -1\ \text{V}$	30	48		

# TLE208x, TLE208xA, TLE208xY EXCALIBUR HIGH-SPEED JFET-INPUT OPERATIONAL AMPLIFIERS

SLOS182B – FEBRUARY 1997 – REVISED JUNE 2001

**TLE2082C electrical characteristics at specified free-air temperature,  $V_{CC\pm} = \pm 5$  V (unless otherwise noted)**

PARAMETER	TEST CONDITIONS	$T_A$ †	TLE2082C			TLE2082AC			UNIT	
			MIN	TYP	MAX	MIN	TYP	MAX		
$V_{IO}$ Input offset voltage	$V_{IC} = 0, V_O = 0, R_S = 50 \Omega$	25°C	0.9	6		0.65	4	mV		
		Full range			8.1		5.1			
$\alpha_{VIO}$ Temperature coefficient of input offset voltage		Full range	2.3	25		2.3	25	$\mu V/^\circ C$		
$I_{IO}$ Input offset current	$V_{IC} = 0, V_O = 0, \text{See Figure 4}$	25°C	5	100		5	100	pA		
		Full range			1.4		1.4	nA		
$I_{IB}$ Input bias current		25°C	15	175		15	175	pA		
		Full range			5		5	nA		
$V_{ICR}$ Common-mode input voltage range	$R_S = 50 \Omega$	25°C	5 to -1	5 to -1.9		5 to -1	5 to -1.9	V		
		Full range	5 to -0.9			5 to -0.9				
$V_{OM+}$ Maximum positive peak output voltage swing	$I_O = -200 \mu A$	25°C	3.8	4.1		3.8	4.1	V		
		Full range			3.7		3.7			
	$I_O = -2 \text{ mA}$	25°C	3.5	3.9		3.5	3.9			
		Full range			3.4		3.4			
$I_O = -20 \text{ mA}$	25°C	1.5	2.3		1.5	2.3				
	Full range			1.5		1.5				
$V_{OM-}$ Maximum negative peak output voltage swing	$I_O = 200 \mu A$	25°C	-3.8	-4.2		-3.8	-4.2	V		
		Full range			-3.7		-3.7			
	$I_O = 2 \text{ mA}$	25°C	-3.5	-4.1		-3.5	-4.1			
		Full range			-3.4		-3.4			
$I_O = 20 \text{ mA}$	25°C	-1.5	-2.4		-1.5	-2.4				
	Full range			-1.5		-1.5				
$A_{VD}$ Large-signal differential voltage amplification	$V_O = \pm 2.3 \text{ V}$	$R_L = 600 \Omega$	25°C	80	91		80	91	dB	
			Full range			79		79		
		$R_L = 2 \text{ k}\Omega$	25°C	90	100		90	100		
			Full range			89		89		
		$R_L = 10 \text{ k}\Omega$	25°C	95	106		95	106		
			Full range			94		94		
$r_i$ Input resistance	$V_{IC} = 0$	25°C	$10^{12}$			$10^{12}$			$\Omega$	
$c_i$ Input capacitance	Common mode	$V_{IC} = 0, \text{See Figure 5}$	25°C	11			11			pF
	Differential		25°C	2.5			2.5			
$z_o$ Open-loop output impedance	$f = 1 \text{ MHz}$	25°C	80			80			$\Omega$	
CMRR Common-mode rejection ratio	$V_{IC} = V_{ICRmin}, V_O = 0, R_S = 50 \Omega$	25°C	70	89		70	89	dB		
		Full range			68		68			
$k_{SVR}$ Supply-voltage rejection ratio ( $\Delta V_{CC\pm} / \Delta V_{IO}$ )	$V_{CC\pm} = \pm 5 \text{ V to } \pm 15 \text{ V}, V_O = 0, R_S = 50 \Omega$	25°C	82	99		82	99	dB		
		Full range			80		80			
$I_{CC}$ Supply current (both channels)	$V_O = 0, \text{No load}$	25°C	2.7	2.9	3.9	2.7	2.9	3.9	mA	
		Full range			3.9		3.9			

† Full range is 0°C to 70°C.



**TLE208x, TLE208xA, TLE208xY**  
**EXCALIBUR HIGH-SPEED JFET-INPUT**  
**OPERATIONAL AMPLIFIERS**

SLOS182B – FEBRUARY 1997 – REVISED JUNE 2001

**TLE2082C electrical characteristics at specified free-air temperature,  $V_{CC\pm} = \pm 5$  V (unless otherwise noted) (continued)**

PARAMETER	TEST CONDITIONS	$T_A$	TLE2082C			TLE2082AC			UNIT
			MIN	TYP	MAX	MIN	TYP	MAX	
Crosstalk attenuation	$V_{IC} = 0$ , $R_L = 2$ k $\Omega$	25°C	120			120			dB
$I_{OS}$ Short-circuit output current	$V_O = 0$	25°C	$V_{ID} = 1$ V			-35			mA
			$V_{ID} = -1$ V			45			

**TLE2082C operating characteristics at specified free-air temperature,  $V_{CC\pm} = \pm 5$  V**

PARAMETER	TEST CONDITIONS	$T_A$ †	TLE2082C			TLE2082AC			UNIT
			MIN	TYP	MAX	MIN	TYP	MAX	
SR+ Positive slew rate	$V_{O(PP)} = \pm 2.3$ V, $A_{VD} = -1$ , $C_L = 100$ pF, $R_L = 2$ k $\Omega$ , See Figure 1	25°C	35			35			V/ $\mu$ s
		Full range	22			22			
SR- Negative slew rate		25°C	38			38			V/ $\mu$ s
		Full range	22			22			
$t_s$ Settling time	$A_{VD} = -1$ , 2-V step, $R_L = 1$ k $\Omega$ , $C_L = 100$ pF	25°C	To 10 mV	0.25		0.25		$\mu$ s	
			To 1 mV	0.4		0.4			
$V_n$ Equivalent input noise voltage	$R_S = 20$ $\Omega$ , See Figure 3	25°C	f = 10 Hz	28		28		nV/ $\sqrt{Hz}$	
			f = 10 kHz	11.6		11.6			
$V_{N(PP)}$ Peak-to-peak equivalent input noise voltage		f = 10 Hz to 10 kHz	25°C	6		6		$\mu$ V	
				f = 0.1 Hz to 10 Hz	0.6		0.6		
$I_n$ Equivalent input noise current	$V_{IC} = 0$ , f = 10 kHz	25°C	2.8		2.8		fA/ $\sqrt{Hz}$		
THD + N Total harmonic distortion plus noise	$V_{O(PP)} = 5$ V, f = 1 kHz, $R_S = 25$ $\Omega$	$A_{VD} = 10$ , $R_L = 2$ k $\Omega$ ,	25°C	0.013%		0.013%			
$B_1$ Unity-gain bandwidth	$V_I = 10$ mV, $C_L = 25$ pF,	$R_L = 2$ k $\Omega$ , See Figure 2	25°C	9.4		9.4		MHz	
$B_{OM}$ Maximum output-swing bandwidth	$V_{O(PP)} = 4$ V, $R_L = 2$ k $\Omega$ ,	$A_{VD} = -1$ , $C_L = 25$ pF	25°C	2.8		2.8		MHz	
$\phi_m$ Phase margin at unity gain	$V_I = 10$ mV, $C_L = 25$ pF,	$R_L = 2$ k $\Omega$ , See Figure 2	25°C	56°		56°			

† Full range is 0°C to 70°C.

# TLE208x, TLE208xA, TLE208xY EXCALIBUR HIGH-SPEED JFET-INPUT OPERATIONAL AMPLIFIERS

SLOS182B – FEBRUARY 1997 – REVISED JUNE 2001

**TLE2082C electrical characteristics at specified free-air temperature,  $V_{CC\pm} = \pm 15\text{ V}$  (unless otherwise noted)**

PARAMETER	TEST CONDITIONS	$T_A$ †	TLE2082C			TLE2082AC			UNIT	
			MIN	TYP	MAX	MIN	TYP	MAX		
$V_{IO}$ Input offset voltage	$V_{IC} = 0,$ $R_S = 50\ \Omega$ $V_O = 0,$	25°C	1.1	7		0.7	4	mV		
		Full range			8.1		5.1			
$\alpha_{VIO}$ Temperature coefficient of input offset voltage		Full range	2.4	25		2.4	25	$\mu\text{V}/^\circ\text{C}$		
$I_{IO}$ Input offset current	$V_{IC} = 0,$ $V_O = 0,$ See Figure 4	25°C	6	100		6	100	pA		
		Full range			1.4		1.4	nA		
$I_{IB}$ Input bias current		25°C	20	175		20	175	pA		
		Full range			5		5	nA		
$V_{ICR}$ Common-mode input voltage range	$R_S = 50\ \Omega$	25°C	15 to -11	15 to -11.9		15 to -11	15 to -11.9	V		
		Full range	15 to -10.9			15 to -10.9				
$V_{OM+}$ Maximum positive peak output voltage swing	$I_O = -200\ \mu\text{A}$	25°C	13.8	14.1		13.8	14.1	V		
		Full range	13.6			13.6				
	$I_O = -2\ \text{mA}$	25°C	13.5	13.9		13.5	13.9			
		Full range	13.4			13.4				
	$I_O = -20\ \text{mA}$	25°C	11.5	12.3		11.5	12.3			
		Full range	11.5			11.5				
$V_{OM-}$ Maximum negative peak output voltage swing	$I_O = 200\ \mu\text{A}$	25°C	-13.8	-14.2		-13.8	-14.2	V		
		Full range	-13.7			-13.7				
	$I_O = 2\ \text{mA}$	25°C	-13.5	-14		-13.5	-14			
		Full range	-13.4			-13.4				
	$I_O = 20\ \text{mA}$	25°C	-11.5	-12.4		-11.5	-12.4			
		Full range	-11.5			-11.5				
$A_{VD}$ Large-signal differential voltage amplification	$V_O = \pm 10\ \text{V}$	$R_L = 600\ \Omega$	25°C	80	96		80	96	dB	
			Full range	79			79			
		$R_L = 2\ \text{k}\Omega$	25°C	90	109		90	109		
			Full range	89			89			
		$R_L = 10\ \text{k}\Omega$	25°C	95	118		95	118		
			Full range	94			94			
$r_i$ Input resistance	$V_{IC} = 0$	25°C	$10^{12}$			$10^{12}$			$\Omega$	
$c_i$ Input capacitance	Common mode	$V_{IC} = 0,$ See Figure 5	25°C	7.5			7.5			pF
	Differential		25°C	2.5			2.5			
$z_o$ Open-loop output impedance	$f = 1\ \text{MHz}$	25°C	80			80			$\Omega$	
CMRR Common-mode rejection ratio	$V_{IC} = V_{ICRmin},$ $V_O = 0,$ $R_S = 50\ \Omega$	25°C	80	98		80	98	dB		
		Full range	79			79				
$k_{SVR}$ Supply-voltage rejection ratio ( $\Delta V_{CC\pm}/\Delta V_{IO}$ )	$V_{CC\pm} = \pm 5\ \text{V}$ to $\pm 15\ \text{V},$ $V_O = 0,$ $R_S = 50\ \Omega$	25°C	82	99		82	99	dB		
		Full range	81			81				

† Full range is 0°C to 70°C.





**TLE208x, TLE208xA, TLE208xY**  
**EXCALIBUR HIGH-SPEED JFET-INPUT**  
**OPERATIONAL AMPLIFIERS**

SLOS182B – FEBRUARY 1997 – REVISED JUNE 2001

**TLE2082C electrical characteristics at specified free-air temperature,  $V_{CC\pm} = \pm 15$  V (unless otherwise noted) (continued)**

PARAMETER	TEST CONDITIONS	$T_A$	TLE2082C			TLE2082AC			UNIT
			MIN	TYP	MAX	MIN	TYP	MAX	
$I_{CC}$ Supply current (both channels)	$V_O = 0$ , No load	25°C	2.7	3.1	3.9	2.7	3.1	3.9	mA
		Full range	3.9			3.9			
Crosstalk attenuation	$V_{IC} = 0$ , $R_L = 2$ k $\Omega$	25°C	120			120			dB
$I_{OS}$ Short-circuit output current	$V_O = 0$	$V_{ID} = 1$ V	25°C	-30	-45	-30	-45	mA	
		$V_{ID} = -1$ V	30	48	30	48			

**TLE2082C operating characteristics at specified free-air temperature,  $V_{CC\pm} = \pm 15$  V**

PARAMETER	TEST CONDITIONS	$T_A$ †	TLE2082C			TLE2082AC			UNIT
			MIN	TYP	MAX	MIN	TYP	MAX	
SR+ Positive slew rate	$V_{O(PP)} = 10$ V, $A_{VD} = -1$ , $R_L = 2$ k $\Omega$ , $C_L = 100$ pF, See Figure 1	25°C	28	40		28	40	V/ $\mu$ s	
		Full range	25			25			
SR- Negative slew rate		25°C	30	45		30	45	V/ $\mu$ s	
		Full range	25			25			
$t_s$ Settling time	$A_{VD} = -1$ , 10-V step, $R_L = 1$ k $\Omega$ , $C_L = 100$ pF	To 10 mV	0.4			0.4			$\mu$ s
		To 1 mV	1.5			1.5			
$V_n$ Equivalent input noise voltage	$R_S = 20$ $\Omega$ , See Figure 3	f = 10 Hz	28			28			nV/ $\sqrt{Hz}$
		f = 10 kHz	11.6			11.6			
$V_{N(PP)}$ Peak-to-peak equivalent input noise voltage		f = 10 Hz to 10 kHz	6			6			$\mu$ V
		f = 0.1 Hz to 10 Hz	0.6			0.6			
$I_n$ Equivalent input noise current	$V_{IC} = 0$ , f = 10 kHz	25°C	2.8			2.8			fA/ $\sqrt{Hz}$
THD + N Total harmonic distortion plus noise	$V_{O(PP)} = 20$ V, $A_{VD} = 10$ , f = 1 kHz, $R_S = 25$ $\Omega$	25°C	0.008%			0.008%			
$B_1$ Unity-gain bandwidth	$V_I = 10$ mV, $R_L = 2$ k $\Omega$ , $C_L = 25$ pF, See Figure 2	25°C	8	10		8	10	MHz	
$B_{OM}$ Maximum output-swing bandwidth	$V_{O(PP)} = 20$ V, $A_{VD} = -1$ , $R_L = 2$ k $\Omega$ , $C_L = 25$ pF	25°C	478	637		478	637	kHz	
$\phi_m$ Phase margin at unity gain	$V_I = 10$ mV, $R_L = 2$ k $\Omega$ , $C_L = 25$ pF, See Figure 2	25°C	57°			57°			

† Full range is 0°C to 70°C.

# TLE208x, TLE208xA, TLE208xY EXCALIBUR HIGH-SPEED JFET-INPUT OPERATIONAL AMPLIFIERS

SLOS182B – FEBRUARY 1997 – REVISED JUNE 2001

**TLE2082I electrical characteristics at specified free-air temperature,  $V_{CC\pm} = \pm 5\text{ V}$  (unless otherwise noted)**

PARAMETER	TEST CONDITIONS	$T_A$ †	TLE2082I			TLE2082AI			UNIT	
			MIN	TYP	MAX	MIN	TYP	MAX		
$V_{IO}$ Input offset voltage	$V_{IC} = 0, V_O = 0, R_S = 50\ \Omega$	25°C	0.9	7		0.65	4	mV		
		Full range			8.5		5.5			
$\alpha_{VIO}$ Temperature coefficient of input offset voltage		Full range	2.4	25		2.4	25	$\mu\text{V}/^\circ\text{C}$		
$I_{IO}$ Input offset current	$V_{IC} = 0, V_O = 0, \text{See Figure 4}$	25°C	5	100		5	100	pA		
		Full range			5		5	nA		
$I_{IB}$ Input bias current		25°C	15	175		15	175	pA		
		Full range			10		10	nA		
$V_{ICR}$ Common-mode input voltage range	$R_S = 50\ \Omega$	25°C	5 to -1	5 to -1.9		5 to -1	5 to -1.9	V		
		Full range	5 to -0.8			5 to -0.8				
$V_{OM+}$ Maximum positive peak output voltage swing	$I_O = -200\ \mu\text{A}$	25°C	3.8	4.1		3.8	4.1	V		
		Full range	3.7			3.7				
	$I_O = -2\ \text{mA}$	25°C	3.5	3.9		3.5	3.9			
		Full range	3.4			3.4				
	$I_O = -20\ \text{mA}$	25°C	1.5	2.3		1.5	2.3			
		Full range	1.5			1.5				
$V_{OM-}$ Maximum negative peak output voltage swing	$I_O = 200\ \mu\text{A}$	25°C	-3.8	-4.2		-3.8	-4.2	V		
		Full range	-3.7			-3.7				
	$I_O = 2\ \text{mA}$	25°C	-3.5	-4.1		-3.5	-4.1			
		Full range	-3.4			-3.4				
	$I_O = 20\ \text{mA}$	25°C	-1.5	-2.4		-1.5	-2.4			
		Full range	-1.5			-1.5				
$A_{VD}$ Large-signal differential voltage amplification	$V_O = \pm 2.3\ \text{V}$	$R_L = 600\ \Omega$	25°C	80	91		80	91	dB	
			Full range	79			79			
		$R_L = 2\ \text{k}\Omega$	25°C	90	100		90	100		
			Full range	89			89			
		$R_L = 10\ \text{k}\Omega$	25°C	95	106		95	106		
			Full range	94			94			
$r_i$ Input resistance	$V_{IC} = 0$	25°C	$10^{12}$			$10^{12}$			$\Omega$	
$c_i$ Input capacitance	Common mode	$V_{IC} = 0$	25°C	11			11			pF
	Differential	See Figure 5	25°C	2.5			2.5			
$z_o$ Open-loop output impedance	$f = 1\ \text{MHz}$	25°C	80			80			$\Omega$	
CMRR Common-mode rejection ratio	$V_{IC} = V_{ICRmin}, V_O = 0, R_S = 50\ \Omega$	25°C	70	89		70	89	dB		
		Full range	68			68				
$k_{SVR}$ Supply-voltage rejection ratio ( $\Delta V_{CC\pm}/\Delta V_{IO}$ )	$V_{CC\pm} = \pm 5\ \text{V to } \pm 15\ \text{V}, V_O = 0, R_S = 50\ \Omega$	25°C	82	99		82	99	dB		
		Full range	80			80				
$I_{CC}$ Supply current (both channels)	$V_O = 0, \text{No load}$	25°C	2.7	2.9	3.9	2.7	2.9	3.9	mA	
		Full range			3.9			3.9		

† Full range is  $-40^\circ\text{C}$  to  $85^\circ\text{C}$ .



**TLE208x, TLE208xA, TLE208xY**  
**EXCALIBUR HIGH-SPEED JFET-INPUT**  
**OPERATIONAL AMPLIFIERS**

SLOS182B – FEBRUARY 1997 – REVISED JUNE 2001

**TLE2082I electrical characteristics at specified free-air temperature,  $V_{CC\pm} = \pm 5\text{ V}$  (unless otherwise noted) (continued)**

PARAMETER	TEST CONDITIONS	$T_A$	TLE2082I			TLE2082AI			UNIT
			MIN	TYP	MAX	MIN	TYP	MAX	
Crosstalk attenuation	$V_{IC} = 0$ , $R_L = 2\text{ k}\Omega$	25°C	120			120			dB
$I_{OS}$ Short-circuit output current	$V_O = 0$	25°C	$V_{ID} = 1\text{ V}$			-35			mA
			$V_{ID} = -1\text{ V}$			45			

**TLE2082I operating characteristics at specified free-air temperature,  $V_{CC\pm} = \pm 5\text{ V}$**

PARAMETER	TEST CONDITIONS	$T_A$ †	TLE2082I			TLE2082AI			UNIT	
			MIN	TYP	MAX	MIN	TYP	MAX		
SR+ Positive slew rate	$V_{O(PP)} = \pm 2.3\text{ V}$ , $A_{VD} = -1$ , $R_L = 2\text{ k}\Omega$ , $C_L = 100\text{ pF}$ , See Figure 1	25°C	35			35			V/ $\mu\text{s}$	
		Full range	20			20				
SR- Negative slew rate		25°C	38			38			V/ $\mu\text{s}$	
		Full range	20			20				
$t_s$ Settling time	$A_{VD} = -1$ , 2-V step, $R_L = 1\text{ k}\Omega$ , $C_L = 100\text{ pF}$	25°C	To 10 mV			0.25			$\mu\text{s}$	
			To 1 mV			0.4				
$V_n$ Equivalent input noise voltage		25°C	f = 10 Hz			28			nV/ $\sqrt{\text{Hz}}$	
			f = 10 kHz			11.6				
$V_{N(PP)}$ Peak-to-peak equivalent input noise voltage	$R_S = 20\ \Omega$ , See Figure 3	25°C	f = 10 Hz to 10 kHz			6			$\mu\text{V}$	
			f = 0.1 Hz to 10 Hz			0.6				
$I_n$ Equivalent input noise current	$V_{IC} = 0$ , f = 10 kHz	25°C	2.8			2.8			fA/ $\sqrt{\text{Hz}}$	
THD + N Total harmonic distortion plus noise	$V_{O(PP)} = 5\text{ V}$ , f = 1 kHz, $R_S = 25\ \Omega$	$A_{VD} = 10$ , $R_L = 2\text{ k}\Omega$ ,	25°C	0.013%			0.013%			
$B_1$ Unity-gain bandwidth	$V_I = 10\text{ mV}$ , $C_L = 25\text{ pF}$ ,	$R_L = 2\text{ k}\Omega$ , See Figure 2	25°C	9.4			9.4			MHz
$B_{OM}$ Maximum output-swing bandwidth	$V_{O(PP)} = 4\text{ V}$ , $R_L = 2\text{ k}\Omega$ ,	$A_{VD} = -1$ , $C_L = 25\text{ pF}$	25°C	2.8			2.8			MHz
$\phi_m$ Phase margin at unity gain	$V_I = 10\text{ mV}$ , $C_L = 25\text{ pF}$ ,	$R_L = 2\text{ k}\Omega$ , See Figure 2	25°C	56°			56°			

† Full range is 40°C to 85°C.

# TLE208x, TLE208xA, TLE208xY EXCALIBUR HIGH-SPEED JFET-INPUT OPERATIONAL AMPLIFIERS

SLOS182B – FEBRUARY 1997 – REVISED JUNE 2001

**TLE2082I electrical characteristics at specified free-air temperature,  $V_{CC\pm} = \pm 15\text{ V}$  (unless otherwise noted)**

PARAMETER	TEST CONDITIONS	$T_A$ †	TLE2082I			TLE2082AI			UNIT	
			MIN	TYP	MAX	MIN	TYP	MAX		
$V_{IO}$ Input offset voltage	$V_{IC} = 0,$ $R_S = 50\ \Omega$ $V_O = 0,$	25°C	1.1	7		0.7	4	mV		
		Full range			8.5		5.5			
$\alpha_{VIO}$ Temperature coefficient of input offset voltage		Full range	2.4	25		2.4	25	$\mu\text{V}/^\circ\text{C}$		
$I_{IO}$ Input offset current	$V_{IC} = 0,$ $V_O = 0,$ See Figure 4	25°C	6	100		6	100	pA		
		Full range			5		5	nA		
$I_{IB}$ Input bias current		25°C	20	175		20	175	pA		
		Full range			10		10	nA		
$V_{ICR}$ Common-mode input voltage range	$R_S = 50\ \Omega$	25°C	15 to -11	15 to -11.9		15 to -11	15 to -11.9	V		
		Full range	15 to -10.8			15 to -10.8				
$V_{OM+}$ Maximum positive peak output voltage swing	$I_O = -200\ \mu\text{A}$	25°C	13.8	14.1		13.8	14.1	V		
		Full range	13.7			13.7				
	$I_O = -2\ \text{mA}$	25°C	13.5	13.9		13.5	13.9			
		Full range	13.4			13.4				
	$I_O = -20\ \text{mA}$	25°C	11.5	12.3		11.5	12.3			
		Full range	11.5			11.5				
$V_{OM-}$ Maximum negative peak output voltage swing	$I_O = 200\ \mu\text{A}$	25°C	-13.8	-14.2		-13.8	-14.2	V		
		Full range	-13.7			-13.7				
	$I_O = 2\ \text{mA}$	25°C	-13.5	-14		-13.5	-14			
		Full range	-13.4			-13.4				
	$I_O = 20\ \text{mA}$	25°C	-11.5	-12.4		-11.5	-12.4			
		Full range	-11.5			-11.5				
$A_{VD}$ Large-signal differential voltage amplification	$V_O = \pm 10\ \text{V}$	$R_L = 600\ \Omega$	25°C	80	96		80	96	dB	
			Full range	79			79			
		$R_L = 2\ \text{k}\Omega$	25°C	90	109		90	109		
			Full range	89			89			
		$R_L = 10\ \text{k}\Omega$	25°C	95	118		95	118		
			Full range	94			94			
$r_i$ Input resistance	$V_{IC} = 0$	25°C	$10^{12}$			$10^{12}$			$\Omega$	
$c_i$ Input capacitance	Common mode	$V_{IC} = 0,$ See Figure 5	25°C	7.5			7.5			pF
	Differential		25°C	2.5			2.5			
$z_o$ Open-loop output impedance	$f = 1\ \text{MHz}$	25°C	80			80			$\Omega$	
CMRR Common-mode rejection ratio	$V_{IC} = V_{ICRmin},$ $V_O = 0,$ $R_S = 50\ \Omega$	25°C	80	98		80	98	dB		
		Full range	79			79				
$k_{SVR}$ Supply-voltage rejection ratio ( $\Delta V_{CC\pm} / \Delta V_{IO}$ )	$V_{CC\pm} = \pm 5\ \text{V to } \pm 15\ \text{V},$ $V_O = 0,$ $R_S = 50\ \Omega$	25°C	82	99		82	99	dB		
		Full range	80			80				

† Full range is  $-40^\circ\text{C}$  to  $85^\circ\text{C}$ .



**TLE208x, TLE208xA, TLE208xY**  
**EXCALIBUR HIGH-SPEED JFET-INPUT**  
**OPERATIONAL AMPLIFIERS**

SLOS182B – FEBRUARY 1997 – REVISED JUNE 2001

**TLE2082I electrical characteristics at specified free-air temperature,  $V_{CC\pm} = \pm 15$  V (unless otherwise noted) (continued)**

PARAMETER	TEST CONDITIONS	$T_A$	TLE2082I			TLE2082AI			UNIT
			MIN	TYP	MAX	MIN	TYP	MAX	
$I_{CC}$ Supply current (both channels)	$V_O = 0$ , No load	25°C	2.7	3.1	3.9	2.7	3.1	3.9	mA
		Full range	3.9			3.9			
Crosstalk attenuation	$V_{IC} = 0$ , $R_L = 2$ k $\Omega$	25°C	120			120			dB
$I_{OS}$ Short-circuit output current	$V_O = 0$	25°C	$V_{ID} = 1$ V	-30	-45	-30	-45	mA	
			$V_{ID} = -1$ V	30	48	30	48		

**TLE2082I operating characteristics at specified free-air temperature,  $V_{CC\pm} = \pm 15$  V**

PARAMETER	TEST CONDITIONS	$T_A$ †	TLE2082I			TLE2082AI			UNIT
			MIN	TYP	MAX	MIN	TYP	MAX	
SR+ Positive slew rate	$V_{O(PP)} = 10$ V, $A_{VD} = -1$ , $R_L = 2$ k $\Omega$ , $C_L = 100$ pF, See Figure 1	25°C	28	40		28	40	V/ $\mu$ s	
		Full range	22			22			
SR- Negative slew rate		25°C	30	45		30	45	V/ $\mu$ s	
		Full range	22			22			
$t_s$ Settling time	$A_{VD} = -1$ , 10-V step, $R_L = 1$ k $\Omega$ , $C_L = 100$ pF	25°C	To 10 mV	0.4		0.4		$\mu$ s	
			To 1 mV	1.5		1.5			
$V_n$ Equivalent input noise voltage	$R_S = 20$ $\Omega$ , See Figure 3	25°C	f = 10 Hz	28		28		nV/ $\sqrt{\text{Hz}}$	
			f = 10 kHz	11.6		11.6			
$V_{N(PP)}$ Peak-to-peak equivalent input noise voltage		25°C	f = 10 Hz to 10 kHz	6		6		$\mu$ V	
			f = 0.1 Hz to 10 Hz	0.6		0.6			
$I_n$ Equivalent input noise current	$V_{IC} = 0$ , f = 10 kHz	25°C	2.8		2.8		fA/ $\sqrt{\text{Hz}}$		
THD + N Total harmonic distortion plus noise	$V_{O(PP)} = 20$ V, $A_{VD} = 10$ , f = 1 kHz, $R_L = 2$ k $\Omega$ , $R_S = 25$ $\Omega$	25°C	0.008%		0.008%				
$B_1$ Unity-gain bandwidth	$V_I = 10$ mV, $R_L = 2$ k $\Omega$ , $C_L = 25$ pF, See Figure 2	25°C	8	10	8	10	MHz		
$B_{OM}$ Maximum output-swing bandwidth	$V_{O(PP)} = 20$ V, $A_{VD} = -1$ , $R_L = 2$ k $\Omega$ , $C_L = 25$ pF	25°C	478	637	478	637	kHz		
$\phi_m$ Phase margin at unity gain	$V_I = 10$ mV, $R_L = 2$ k $\Omega$ , $C_L = 25$ pF, See Figure 2	25°C	57°		57°				

† Full range is -40°C to 85°C.

# TLE208x, TLE208xA, TLE208xY EXCALIBUR HIGH-SPEED JFET-INPUT OPERATIONAL AMPLIFIERS

SLOS182B – FEBRUARY 1997 – REVISED JUNE 2001

**TLE2082M electrical characteristics at specified free-air temperature,  $V_{CC\pm} = \pm 5\text{ V}$  (unless otherwise noted)**

PARAMETER	TEST CONDITIONS	$T_A$ †	TLE2082M			TLE2082AM			UNIT	
			MIN	TYP	MAX	MIN	TYP	MAX		
$V_{IO}$ Input offset voltage	$V_{IC} = 0, V_O = 0, R_S = 50\ \Omega$	25°C	0.9	7		0.65	4	mV		
		Full range			9.5		6.5			
$\alpha_{VIO}$ Temperature coefficient of input offset voltage		Full range	2.3	25*		2.3	25*	$\mu\text{V}/^\circ\text{C}$		
$I_{IO}$ Input offset current	$V_{IC} = 0, V_O = 0, \text{See Figure 4}$	25°C	5	100		5	100	pA		
		Full range			20		20	nA		
$I_{IB}$ Input bias current		25°C	15	175		15	175	pA		
		Full range			60		60	nA		
$V_{ICR}$ Common-mode input voltage range	$R_S = 50\ \Omega$	25°C	5 to -1	5 to -1.9		5 to -1	5 to -1.9	V		
		Full range	5 to -0.8			5 to -0.8				
$V_{OM+}$ Maximum positive peak output voltage swing	$I_O = -200\ \mu\text{A}$	25°C	3.8	4.1		3.8	4.1	V		
		Full range	3.6			3.6				
	$I_O = -2\ \text{mA}$	25°C	3.5	3.9		3.5	3.9			
		Full range	3.3			3.3				
$I_O = -20\ \text{mA}$	25°C	1.5	2.3		1.5	2.3				
	Full range	1.4			1.4					
$V_{OM-}$ Maximum negative peak output voltage swing	$I_O = 200\ \mu\text{A}$	25°C	-3.8	-4.2		-3.8	-4.2	V		
		Full range	-3.6			-3.6				
	$I_O = 2\ \text{mA}$	25°C	-3.5	-4.1		-3.5	-4.1			
		Full range	-3.3			-3.3				
$I_O = 20\ \text{mA}$	25°C	-1.5	-2.4		-1.5	-2.4				
	Full range	-1.4			-1.4					
$A_{VD}$ Large-signal differential voltage amplification	$V_O = \pm 2.3\ \text{V}$	$R_L = 600\ \Omega$	25°C	80	91		80	91	dB	
			Full range	78			78			
		$R_L = 2\ \text{k}\Omega$	25°C	90	100		90	100		
			Full range	88			88			
		$R_L = 10\ \text{k}\Omega$	25°C	95	106		95	106		
			Full range	93			93			
$r_i$ Input resistance	$V_{IC} = 0$	25°C	$10^{12}$			$10^{12}$			$\Omega$	
$c_i$ Input capacitance	Common mode	$V_{IC} = 0, \text{See Figure 5}$	25°C	11			11			pF
	Differential		25°C	2.5			2.5			
$z_o$ Open-loop output impedance	$f = 1\ \text{MHz}$	25°C	80			80			$\Omega$	
CMRR Common-mode rejection ratio	$V_{IC} = V_{ICR\text{min}}, V_O = 0, R_S = 50\ \Omega$	25°C	70	89		70	89	dB		
		Full range	68			68				
$k_{SVR}$ Supply-voltage rejection ratio ( $\Delta V_{CC\pm} / \Delta V_{IO}$ )	$V_{CC\pm} = \pm 5\ \text{V to } \pm 15\ \text{V}, V_O = 0, R_S = 50\ \Omega$	25°C	82	99		82	99	dB		
		Full range	80			80				

\*On products compliant with MIL-PRF-38535, Class B, this parameter is not production tested.

† Full range is  $-55^\circ\text{C}$  to  $125^\circ\text{C}$ .



**TLE208x, TLE208xA, TLE208xY**  
**EXCALIBUR HIGH-SPEED JFET-INPUT**  
**OPERATIONAL AMPLIFIERS**

SLOS182B – FEBRUARY 1997 – REVISED JUNE 2001

**TLE2082M electrical characteristics at specified free-air temperature,  $V_{CC\pm} = \pm 5$  V (unless otherwise noted) (continued)**

PARAMETER	TEST CONDITIONS	$T_A$ †	TLE2082M			TLE2082AM			UNIT
			MIN	TYP	MAX	MIN	TYP	MAX	
$I_{CC}$ Supply current (both channels)	$V_O = 0$ , No load	25°C	2.7	2.9	3.6	2.7	2.9	3.6	mA
		Full range	3.6			3.6			
Crosstalk attenuation	$V_{IC} = 0$ , $R_L = 2$ k $\Omega$	25°C	120			120			dB
$I_{OS}$ Short-circuit output current	$V_O = 0$	25°C	$V_{ID} = 1$ V			–35			mA
			$V_{ID} = -1$ V			45			

† Full range is –55°C to 125°C.

**TLE2082M operating characteristics at specified free-air temperature,  $V_{CC\pm} = \pm 5$  V**

PARAMETER	TEST CONDITIONS	$T_A$ †	TLE2082M			TLE2082AM			UNIT	
			MIN	TYP	MAX	MIN	TYP	MAX		
SR+ Positive slew rate	$V_{O(PP)} = \pm 2.3$ V, $A_{VD} = -1$ , $R_L = 2$ k $\Omega$ , $C_L = 100$ pF, See Figure 1	25°C	35			35			V/ $\mu$ s	
		Full range	18*			18*				
SR– Negative slew rate	$V_{O(PP)} = \pm 2.3$ V, $A_{VD} = -1$ , $R_L = 2$ k $\Omega$ , $C_L = 100$ pF, See Figure 1	25°C	38			38			V/ $\mu$ s	
		Full range	18*			18*				
$t_s$ Settling time	$A_{VD} = -1$ , 2-V step, $R_L = 1$ k $\Omega$ , $C_L = 100$ pF	25°C	To 10 mV	0.25			0.25			$\mu$ s
			To 1 mV	0.4			0.4			
$V_n$ Equivalent input noise voltage	$R_S = 20$ $\Omega$ , See Figure 3	25°C	f = 10 Hz	28			28			nV/ $\sqrt{Hz}$
			f = 10 kHz	11.6			11.6			
$V_{N(PP)}$ Peak-to-peak equivalent input noise voltage	$R_S = 20$ $\Omega$ , See Figure 3	25°C	f = 10 Hz to 10 kHz	6			6			$\mu$ V
			f = 0.1 Hz to 10 Hz	0.6			0.6			
$I_n$ Equivalent input noise current	$V_{IC} = 0$ , f = 10 kHz	25°C	2.8			2.8			fA/ $\sqrt{Hz}$	
THD + N Total harmonic distortion plus noise	$V_{O(PP)} = 5$ V, $A_{VD} = 10$ , f = 1 kHz, $R_L = 2$ k $\Omega$ , $R_S = 25$ $\Omega$	25°C	0.013%			0.013%				
$B_1$ Unity-gain bandwidth	$V_I = 10$ mV, $R_L = 2$ k $\Omega$ , $C_L = 25$ pF, See Figure 2	25°C	9.4			9.4			MHz	
$B_{OM}$ Maximum output-swing bandwidth	$V_{O(PP)} = 4$ V, $A_{VD} = -1$ , $R_L = 2$ k $\Omega$ , $C_L = 25$ pF	25°C	2.8			2.8			MHz	
$\phi_m$ Phase margin at unity gain	$V_I = 10$ mV, $R_L = 2$ k $\Omega$ , $C_L = 25$ pF, See Figure 2	25°C	56°			56°				

\*On products compliant with MIL-PRF-38535, Class B, this parameter is not production tested.

† Full range is –55°C to 125°C.

# TLE208x, TLE208xA, TLE208xY EXCALIBUR HIGH-SPEED JFET-INPUT OPERATIONAL AMPLIFIERS

SLOS182B – FEBRUARY 1997 – REVISED JUNE 2001

**TLE2082M electrical characteristics at specified free-air temperature,  $V_{CC\pm} = \pm 15$  V (unless otherwise noted)**

PARAMETER	TEST CONDITIONS	$T_A$ †	TLE2082M			TLE2082AM			UNIT	
			MIN	TYP	MAX	MIN	TYP	MAX		
$V_{IO}$ Input offset voltage	$V_{IC} = 0, V_O = 0, R_S = 50 \Omega$	25°C	1.1	7		0.7	4	mV		
		Full range			9.5		6.5			
$\alpha_{VIO}$ Temperature coefficient of input offset voltage		Full range	2.4	25*		2.4	25*	$\mu V/^\circ C$		
$I_{IO}$ Input offset current	$V_{IC} = 0, V_O = 0, \text{See Figure 4}$	25°C	6	100		6	100	pA		
		Full range			20		20	nA		
$I_{IB}$ Input bias current		25°C	20	175		20	175	pA		
		Full range			65		65	nA		
$V_{ICR}$ Common-mode input voltage range	$R_S = 50 \Omega$	25°C	15 to -11	15 to -11.9		15 to -11	15 to -11.9	V		
		Full range	15 to -10.8			15 to -10.8				
$V_{OM+}$ Maximum positive peak output voltage swing	$I_O = -200 \mu A$	25°C	13.8	14.1		13.8	14.1	V		
		Full range	13.6			13.6				
	$I_O = -2 \text{ mA}$	25°C	13.5	13.9		13.5	13.9			
		Full range	13.3			13.3				
	$I_O = -20 \text{ mA}$	25°C	11.5	12.3		11.5	12.3			
		Full range	11.4			11.4				
$V_{OM-}$ Maximum negative peak output voltage swing	$I_O = 200 \mu A$	25°C	-13.8	-14.2		-13.8	-14.2	V		
		Full range	-13.6			-13.6				
	$I_O = 2 \text{ mA}$	25°C	-13.5	-14		-13.5	-14			
		Full range	-13.3			-13.3				
	$I_O = 20 \text{ mA}$	25°C	-11.5	-12.4		-11.5	-12.4			
		Full range	-11.4			-11.4				
$A_{VD}$ Large-signal differential voltage amplification	$V_O = \pm 10 \text{ V}$	$R_L = 600 \Omega$	25°C	80	96		80	96	dB	
			Full range	78			78			
		$R_L = 2 \text{ k}\Omega$	25°C	90	109		90	109		
			Full range	88			88			
		$R_L = 10 \text{ k}\Omega$	25°C	95	118		95	118		
			Full range	93			93			
$r_i$ Input resistance	$V_{IC} = 0$	25°C	$10^{12}$			$10^{12}$			$\Omega$	
$c_i$ Input capacitance	Common mode	$V_{IC} = 0, \text{See Figure 5}$	25°C	7.5			7.5			pF
	Differential		25°C	2.5			2.5			
$z_o$ Open-loop output impedance	$f = 1 \text{ MHz}$	25°C	80			80			$\Omega$	
CMRR Common-mode rejection ratio	$V_{IC} = V_{ICRmin}, V_O = 0, R_S = 50 \Omega$	25°C	80	98		80	98	dB		
		Full range	78			78				
$k_{SVR}$ Supply-voltage rejection ratio ( $\Delta V_{CC\pm}/\Delta V_{IO}$ )	$V_{CC\pm} = \pm 5 \text{ V to } \pm 15 \text{ V}, V_O = 0, R_S = 50 \Omega$	25°C	82	99		82	99	dB		
		Full range	80			80				

\*On products compliant with MIL-PRF-38535, Class B, this parameter is not production tested.

† Full range is  $-55^\circ C$  to  $125^\circ C$ .





**TLE208x, TLE208xA, TLE208xY**  
**EXCALIBUR HIGH-SPEED JFET-INPUT**  
**OPERATIONAL AMPLIFIERS**

SLOS182B – FEBRUARY 1997 – REVISED JUNE 2001

**TLE2082M electrical characteristics at specified free-air temperature,  $V_{CC\pm} = \pm 15$  V (unless otherwise noted) (continued)**

PARAMETER	TEST CONDITIONS	$T_A$ †	TLE2082M			TLE2082AM			UNIT	
			MIN	TYP	MAX	MIN	TYP	MAX		
$I_{CC}$	Supply current (both channels)	$V_O = 0$ , No load	25°C	2.7	3.1	3.6	2.7	3.1	3.6	mA
			Full range	3.6			3.6			
	Crosstalk attenuation	$V_{IC} = 0$ , $R_L = 2$ k $\Omega$	25°C	120			120			dB
$I_{OS}$	Short-circuit output current	$V_O = 0$	$V_{ID} = 1$ V	25°C	-30	-45	-30	-45	mA	
			$V_{ID} = -1$ V		30	48	30	48		

† Full range is  $-55^\circ\text{C}$  to  $125^\circ\text{C}$ .

**TLE2082M operating characteristics at specified free-air temperature,  $V_{CC\pm} = \pm 15$  V**

PARAMETER	TEST CONDITIONS	$T_A$ †	TLE2082M			TLE2082AM			UNIT
			MIN	TYP	MAX	MIN	TYP	MAX	
SR+	Positive slew rate	$V_{O(PP)} = 10$ V, $A_{VD} = -1$ , $R_L = 2$ k $\Omega$ , $C_L = 100$ pF, See Figure 1	25°C	28	40	28	40	V/ $\mu$ s	
			Full range	20			20		
SR-	Negative slew rate	$V_{O(PP)} = 10$ V, $A_{VD} = -1$ , $R_L = 2$ k $\Omega$ , $C_L = 100$ pF, See Figure 1	25°C	30	45	30	45	V/ $\mu$ s	
			Full range	20			20		
$t_s$	Settling time	$A_{VD} = -1$ , 10-V step, $R_L = 1$ k $\Omega$ , $C_L = 100$ pF	To 10 mV	25°C	0.4			$\mu$ s	
			To 1 mV		1.5				
$V_n$	Equivalent input noise voltage	$R_S = 20$ $\Omega$ , See Figure 3	f = 10 Hz	25°C	28			nV/ $\sqrt{\text{Hz}}$	
			f = 10 kHz		11.6				
$V_{N(PP)}$	Peak-to-peak equivalent input noise voltage	$R_S = 20$ $\Omega$ , See Figure 3	f = 10 Hz to 10 kHz	25°C	6			$\mu$ V	
			f = 0.1 Hz to 10 Hz		0.6				
$I_n$	Equivalent input noise current	$V_{IC} = 0$ , f = 10 kHz	25°C	2.8			fA/ $\sqrt{\text{Hz}}$		
THD + N	Total harmonic distortion plus noise	$V_{O(PP)} = 20$ V, $A_{VD} = 10$ , f = 1 kHz, $R_L = 2$ k $\Omega$ , $R_S = 25$ $\Omega$	25°C	0.008%			0.008%		
$B_1$	Unity-gain bandwidth	$V_I = 10$ mV, $R_L = 2$ k $\Omega$ , $C_L = 25$ pF, See Figure 2	25°C	8*	10	8*	10	MHz	
BOM	Maximum output-swing bandwidth	$V_{O(PP)} = 20$ V, $A_{VD} = -1$ , $R_L = 2$ k $\Omega$ , $C_L = 25$ pF	25°C	478*	637	478*	637	kHz	
$\phi_m$	Phase margin at unity gain	$V_I = 10$ mV, $R_L = 2$ k $\Omega$ , $C_L = 25$ pF, See Figure 2	25°C	57°			57°		

\*On products compliant with MIL-PRF-38535, Class B, this parameter is not production tested.

† Full range is  $-55^\circ\text{C}$  to  $125^\circ\text{C}$ .



**TLE208x, TLE208xA, TLE208xY**  
**EXCALIBUR HIGH-SPEED JFET-INPUT**  
**OPERATIONAL AMPLIFIERS**

SLOS182B – FEBRUARY 1997 – REVISED JUNE 2001

**TLE2082Y electrical characteristics at  $V_{CC\pm} = \pm 15\text{ V}$ ,  $T_A = 25^\circ\text{C}$**

PARAMETER		TEST CONDITIONS			TLE2082Y			UNIT	
					MIN	TYP	MAX		
$V_{IO}$	Input offset voltage	$V_{IC} = 0$ ,	$V_O = 0$ ,	$R_S = 50\ \Omega$	1.1	6		mV	
$I_{IO}$	Input offset current	$V_{IC} = 0$ ,	$V_O = 0$ ,	See Figure 4	6	100		pA	
$I_{IB}$	Input bias current				20	175		pA	
$V_{ICR}$	Common-mode input voltage range	$R_S = 50\ \Omega$			15 to -11	15 to 11.9		V	
$V_{OM+}$	Maximum positive peak output voltage swing	$I_O = -200\ \mu\text{A}$			13.8	14.1		V	
		$I_O = -2\ \text{mA}$			13.5	13.9			
		$I_O = -20\ \text{mA}$			11.5	12.3			
$V_{OM-}$	Maximum negative peak output voltage swing	$I_O = 200\ \mu\text{A}$			-13.8	-14.2		V	
		$I_O = 2\ \text{mA}$			-13.5	-14			
		$I_O = 20\ \text{mA}$			-11.5	-12.4			
$A_{VD}$	Large-signal differential voltage amplification	$V_O = \pm 10\ \text{V}$	$R_L = 600\ \Omega$		80	96		dB	
			$R_L = 2\ \text{k}\Omega$		90	109			
			$R_L = 10\ \text{k}\Omega$		95	118			
$r_i$	Input resistance	$V_{IC} = 0$			10 <sup>12</sup>			$\Omega$	
$c_i$	Input capacitance	Common mode	$V_O = 0$ , See Figure 5			7.5		pF	
		Differential				2.5			
$z_o$	Open-loop output impedance	$f = 1\ \text{MHz}$			80			$\Omega$	
CMRR	Common-mode rejection ratio	$V_{IC} = V_{ICRmin}$ , $V_O = 0$ , $R_S = 50\ \Omega$			80	98		dB	
$k_{SVR}$	Supply-voltage rejection ratio ( $\Delta V_{CC\pm} / \Delta V_{IO}$ )	$V_{CC\pm} = \pm 5\ \text{V to } \pm 15\ \text{V}$ , $V_O = 0$ , $R_S = 50\ \Omega$			82	99		dB	
$I_{CC}$	Supply current (both channels)	$V_O = 0$ , No load			2.7	3.1	3.9	mA	
$I_{OS}$	Short-circuit output current	$V_O = 0$			$V_{ID} = 1\ \text{V}$		-30	-45	mA
					$V_{ID} = -1\ \text{V}$		30	48	



**TLE208x, TLE208xA, TLE208xY**  
**EXCALIBUR HIGH-SPEED JFET-INPUT**  
**OPERATIONAL AMPLIFIERS**

SLOS182B – FEBRUARY 1997 – REVISED JUNE 2001

**TLE2084C electrical characteristics at specified free-air temperature,  $V_{CC\pm} = \pm 5\text{ V}$  (unless otherwise noted)**

PARAMETER	TEST CONDITIONS	$T_A$ †	TLE2084C			TLE2084AC			UNIT	
			MIN	TYP	MAX	MIN	TYP	MAX		
$V_{IO}$ Input offset voltage	$V_{IC} = 0, V_O = 0, R_S = 50\ \Omega$	25°C	-1.6	7		-0.5	4	mV		
		Full range			9.1		6.1			
$\alpha_{VIO}$ Temperature coefficient of input offset voltage		Full range	10.1	30		10.1	30	$\mu\text{V}/^\circ\text{C}$		
$I_{IO}$ Input offset current	$V_{IC} = 0, V_O = 0, \text{See Figure 4}$	25°C	15	100		15	100	pA		
		Full range			1.4		1.4	nA		
$I_{IB}$ Input bias current		25°C	20	175		20	175	pA		
		Full range			5		5	nA		
$V_{ICR}$ Common-mode input voltage range	$R_S = 50\ \Omega$	25°C	5 to -1	5 to -1.9		5 to -1	5 to -1.9	V		
		Full range	5 to -0.9			5 to -0.9				
$V_{OM+}$ Maximum positive peak output voltage swing	$I_O = -200\ \mu\text{A}$	25°C	3.8	4.1		3.8	4.1	V		
		Full range	3.7			3.7				
	$I_O = -2\ \text{mA}$	25°C	3.5	3.9		3.5	3.9			
		Full range	3.4			3.4				
	$I_O = -20\ \text{mA}$	25°C	1.5	2.3		1.5	2.3			
		Full range	1.5			1.5				
$V_{OM-}$ Maximum negative peak output voltage swing	$I_O = 200\ \mu\text{A}$	25°C	-3.8	-4.2		-3.8	-4.2	V		
		Full range	-3.7			-3.7				
	$I_O = 2\ \text{mA}$	25°C	-3.5	-4.1		-3.5	-4.1			
		Full range	-3.4			-3.4				
	$I_O = 20\ \text{mA}$	25°C	-1.5	-2.4		-1.5	-2.4			
		Full range	-1.5			-1.5				
$A_{VD}$ Large-signal differential voltage amplification	$V_O = \pm 2.3\ \text{V}$	$R_L = 600\ \Omega$	25°C	80	91		80	91	dB	
			Full range	79			79			
		$R_L = 2\ \text{k}\Omega$	25°C	90	100		90	100		
			Full range	89			89			
		$R_L = 10\ \text{k}\Omega$	25°C	95	106		95	106		
			Full range	94			94			
$r_i$ Input resistance	$V_{IC} = 0$	25°C	$10^{12}$			$10^{12}$			$\Omega$	
$c_i$ Input capacitance	$V_{IC} = 0, \text{See Figure 5}$	Common mode	25°C	11			11			pF
		Differential	25°C	2.5			2.5			
$z_o$ Open-loop output impedance	$f = 1\ \text{MHz}$	25°C	80			80			$\Omega$	
CMRR Common-mode rejection ratio	$V_{IC} = V_{ICRmin}, V_O = 0, R_S = 50\ \Omega$	25°C	70	89		70	89	dB		
		Full range	68			68				
$k_{SVR}$ Supply-voltage rejection ratio ( $\Delta V_{CC\pm} / \Delta V_{IO}$ )	$V_{CC\pm} = \pm 5\ \text{V to } \pm 15\ \text{V}, V_O = 0, R_S = 50\ \Omega$	25°C	82	99		82	99	dB		
		Full range	80			80				
$I_{CC}$ Supply current (four amplifiers)	$V_O = 0, \text{No load}$	25°C	5.2	6.3	7.5	5.2	6.3	7.5	mA	
		Full range			7.5			7.5		
$a_x$ Crosstalk attenuation	$V_{IC} = 0, R_L = 2\ \text{k}\Omega$	25°C	120			120			dB	

† Full range is 0°C to 70°C.



**TLE208x, TLE208xA, TLE208xY**  
**EXCALIBUR HIGH-SPEED JFET-INPUT**  
**OPERATIONAL AMPLIFIERS**

SLOS182B – FEBRUARY 1997 – REVISED JUNE 2001

**TLE2084C electrical characteristics at specified free-air temperature,  $V_{CC\pm} = \pm 5\text{ V}$  (unless otherwise noted) (continued)**

PARAMETER	TEST CONDITIONS	$T_A$ †	TLE2084C			TLE2084AC			UNIT
			MIN	TYP	MAX	MIN	TYP	MAX	
$I_{OS}$	Short-circuit output current $V_O = 0$	25°C	$V_{ID} = 1\text{ V}$			-35			mA
			$V_{ID} = -1\text{ V}$			45			

† Full range is 0°C to 70°C.

**TLE2084C operating characteristics at specified free-air temperature,  $V_{CC\pm} = \pm 5\text{ V}$**

PARAMETER	TEST CONDITIONS	$T_A$ †	TLE2084C			TLE2084AC			UNIT	
			MIN	TYP	MAX	MIN	TYP	MAX		
SR+	Positive slew rate $V_{O(PP)} = \pm 2.3\text{ V}$ , $A_{VD} = -1$ , $R_L = 2\text{ k}\Omega$ , $C_L = 100\text{ pF}$ , See Figure 1	25°C	35			35			$\text{V}/\mu\text{s}$	
		Full range	22			22				
SR-	Negative slew rate	25°C	38			38			$\text{V}/\mu\text{s}$	
		Full range	22			22				
$t_s$	Settling time $A_{VD} = -1$ , 2-V step, $R_L = 1\text{ k}\Omega$ , $C_L = 100\text{ pF}$	25°C	To 10 mV	0.25			0.25			$\mu\text{s}$
			To 1 mV	0.4			0.4			
$V_n$	Equivalent input noise voltage $R_S = 20\ \Omega$ , See Figure 3	25°C	f = 10 Hz	28			28			$\text{nV}/\sqrt{\text{Hz}}$
			f = 10 kHz	11.6			11.6			
$V_{N(PP)}$	Peak-to-peak equivalent input noise voltage	25°C	f = 10 Hz to 10 kHz	6			6			$\mu\text{V}$
			f = 0.1 Hz to 10 Hz	0.6			0.6			
$I_n$	Equivalent input noise current $V_{IC} = 0$ , f = 10 kHz	25°C	2.8			2.8			$\text{fA}/\sqrt{\text{Hz}}$	
THD + N	Total harmonic distortion plus noise $V_{O(PP)} = 5\text{ V}$ , f = 1 kHz, $R_S = 25\ \Omega$ , $A_{VD} = 10$ , $R_L = 2\text{ k}\Omega$	25°C	0.013%			0.013%				
$B_1$	Unity-gain bandwidth $V_I = 10\text{ mV}$ , $C_L = 25\text{ pF}$ , $R_L = 2\text{ k}\Omega$ , See Figure 2	25°C	9.4			9.4			MHz	
BOM	Maximum output-swing bandwidth $V_{O(PP)} = 4\text{ V}$ , $R_L = 2\text{ k}\Omega$ , $A_{VD} = -1$ , $C_L = 25\text{ pF}$	25°C	2.8			2.8			MHz	
$\phi_m$	Phase margin at unity gain $V_I = 10\text{ mV}$ , $C_L = 25\text{ pF}$ , $R_L = 2\text{ k}\Omega$ , See Figure 2	25°C	56°			56°				

† Full range is 0°C to 70°C.



**TLE208x, TLE208xA, TLE208xY**  
**EXCALIBUR HIGH-SPEED JFET-INPUT**  
**OPERATIONAL AMPLIFIERS**

SLOS182B – FEBRUARY 1997 – REVISED JUNE 2001

**TLE2084C electrical characteristics at specified free-air temperature,  $V_{CC\pm} = \pm 15$  V (unless otherwise noted)**

PARAMETER	TEST CONDITIONS	$T_A$ †	TLE2084C			TLE2084AC			UNIT	
			MIN	TYP	MAX	MIN	TYP	MAX		
$V_{IO}$ Input offset voltage	$V_{IC} = 0, V_O = 0, R_S = 50 \Omega$	25°C	-1.6	7		-0.5	4	mV		
		Full range			9.1		6.1			
$\alpha_{VIO}$ Temperature coefficient of input offset voltage		Full range	10.1	30		10.1	30	$\mu V/^\circ C$		
$I_{IO}$ Input offset current	$V_{IC} = 0, V_O = 0, \text{See Figure 4}$	25°C	15	100		15	100	pA		
		Full range			1.4		1.4	nA		
$I_{IB}$ Input bias current		25°C	25	175		25	175	pA		
		Full range			5		5	nA		
$V_{ICR}$ Common-mode input voltage range	$R_S = 50 \Omega$	25°C	15 to -11	15 to -11.9		15 to -11	15 to -11.9	V		
		Full range	15 to -10.9			15 to -10.9				
$V_{OM+}$ Maximum positive peak output voltage swing	$I_O = -200 \mu A$	25°C	13.8	14.1		13.8	14.1	V		
		Full range	13.7			13.7				
	$I_O = -2 \text{ mA}$	25°C	13.5	13.9		13.5	13.9			
		Full range	13.4			13.4				
	$I_O = -20 \text{ mA}$	25°C	11.5	12.3		11.5	12.3			
		Full range	11.5			11.5				
$V_{OM-}$ Maximum negative peak output voltage swing	$I_O = 200 \mu A$	25°C	-13.8	-14.2		-13.8	-14.2	V		
		Full range	-13.7			-13.7				
	$I_O = 2 \text{ mA}$	25°C	-13.7	-14		-13.7	-14			
		Full range	-13.6			-13.6				
	$I_O = 20 \text{ mA}$	25°C	-11.5	-12.4		-11.5	-12.4			
		Full range	-11.5			-11.5				
$A_{VD}$ Large-signal differential voltage amplification	$V_O = \pm 10 \text{ V}$	$R_L = 600 \Omega$	25°C	80	96		80	96	dB	
			Full range	79			79			
		$R_L = 2 \text{ k}\Omega$	25°C	90	109		90	109		
			Full range	89			89			
		$R_L = 10 \text{ k}\Omega$	25°C	95	118		95	118		
			Full range	94			94			
$r_i$ Input resistance	$V_{IC} = 0$	25°C	$10^{12}$			$10^{12}$			$\Omega$	
$c_i$ Input capacitance	$V_{IC} = 0, \text{See Figure 5}$	Common mode	25°C	7.5			7.5			pF
		Differential	25°C	2.5			2.5			
$z_o$ Open-loop output impedance	$f = 1 \text{ MHz}$	25°C	80			80			$\Omega$	
CMRR Common-mode rejection ratio	$V_{IC} = V_{ICRmin}, V_O = 0, R_S = 50 \Omega$	25°C	80	98		80	98	dB		
		Full range	79			79				
$k_{SVR}$ Supply-voltage rejection ratio ( $\Delta V_{CC\pm}/\Delta V_{IO}$ )	$V_{CC\pm} = \pm 5 \text{ V to } \pm 15 \text{ V}, V_O = 0, R_S = 50 \Omega$	25°C	82	99		82	99	dB		
		Full range	81			81				
$I_{CC}$ Supply current (four amplifiers)	$V_O = 0, \text{No load}$	25°C	5.2	6.5	7.5	5.2	6.5	7.5	mA	
		Full range			7.5			7.5		
$a_x$ Crosstalk attenuation	$V_{IC} = 0, R_L = 2 \text{ k}\Omega$	25°C	120			120			dB	

† Full range is 0°C to 70°C.



# TLE208x, TLE208xA, TLE208xY EXCALIBUR HIGH-SPEED JFET-INPUT OPERATIONAL AMPLIFIERS

SLOS182B – FEBRUARY 1997 – REVISED JUNE 2001

**TLE2084C electrical characteristics at specified free-air temperature,  $V_{CC\pm} = \pm 15\text{ V}$  (unless otherwise noted) (continued)**

PARAMETER	TEST CONDITIONS	$T_A$ †	TLE2084C			TLE2084AC			UNIT
			MIN	TYP	MAX	MIN	TYP	MAX	
$I_{OS}$	Short-circuit output current $V_O = 0$	25°C	$V_{ID} = 1\text{ V}$			$V_{ID} = -1\text{ V}$			mA
			-30	-45		-30	-45		
			30	48		30	48		

† Full range is 0°C to 70°C.

**TLE2084C operating characteristics at specified free-air temperature,  $V_{CC\pm} = \pm 15\text{ V}$**

PARAMETER	TEST CONDITIONS	$T_A$ †	TLE2084C			TLE2084AC			UNIT
			MIN	TYP	MAX	MIN	TYP	MAX	
SR+	Positive slew rate	25°C	25			40			V/μs
			Full range			22			
SR-	Negative slew rate	25°C	30			45			V/μs
			Full range			25			
$t_s$	Settling time	25°C	To 10 mV			0.4			μs
			To 1 mV			1.5			
$V_n$	Equivalent input noise voltage	25°C	f = 10 Hz			28			nV/√Hz
			f = 10 kHz			11.6			
$V_{N(PP)}$	Peak-to-peak equivalent input noise voltage	25°C	f = 10 Hz to 10 kHz			6			μV
			f = 0.1 Hz to 10 Hz			0.6			
$I_n$	Equivalent input noise current	25°C	f = 10 kHz			2.8			fA/√Hz
THD + N	Total harmonic distortion plus noise	25°C	0.008%			0.008%			
$B_1$	Unity-gain bandwidth	25°C	8			10			MHz
$B_{OM}$	Maximum output-swing bandwidth	25°C	478			637			kHz
$\phi_m$	Phase margin at unity gain	25°C	57°			57°			

† Full range is 0°C to 70°C.



**TLE208x, TLE208xA, TLE208xY**  
**EXCALIBUR HIGH-SPEED JFET-INPUT**  
**OPERATIONAL AMPLIFIERS**

SLOS182B – FEBRUARY 1997 – REVISED JUNE 2001

**TLE2084M electrical characteristics at specified free-air temperature,  $V_{CC\pm} = \pm 5\text{ V}$  (unless otherwise noted)**

PARAMETER	TEST CONDITIONS	$T_A$ †	TLE2084M			TLE2084AM			UNIT	
			MIN	TYP	MAX	MIN	TYP	MAX		
$V_{IO}$ Input offset voltage	$V_{IC} = 0, V_O = 0, R_S = 50\ \Omega$	25°C	-1.6	7		-0.5	4	mV		
		Full range			12.5		9.5			
$\alpha_{VIO}$ Temperature coefficient of input offset voltage		Full range	10.1	30*		10.1	30*	$\mu\text{V}/^\circ\text{C}$		
$I_{IO}$ Input offset current	$V_{IC} = 0, V_O = 0, \text{See Figure 4}$	25°C	15	100		15	100	pA		
		Full range			20		20	nA		
$I_{IB}$ Input bias current		25°C	20	175		20	175	pA		
		Full range			65		65	nA		
$V_{ICR}$ Common-mode input voltage range	$R_S = 50\ \Omega$	25°C	5 to -1	5 to -1.9		5 to -1	5 to -1.9	V		
		Full range	5 to -0.8			5 to -0.8				
$V_{OM+}$ Maximum positive peak output voltage swing	$I_O = -200\ \mu\text{A}$	25°C	3.8	4.1		3.8	4.1	V		
		Full range	3.6			3.6				
	$I_O = -2\ \text{mA}$	25°C	3.5	3.9		3.5	3.9			
		Full range	3.3			3.3				
	$I_O = -20\ \text{mA}$	25°C	1.5	2.3		1.5	2.3			
		Full range	1.4			1.4				
$V_{OM-}$ Maximum negative peak output voltage swing	$I_O = 200\ \mu\text{A}$	25°C	-3.8	-4.2		-3.8	-4.2	V		
		Full range	-3.6			-3.6				
	$I_O = 2\ \text{mA}$	25°C	-3.5	-4.1		-3.5	-4.1			
		Full range	-3.3			-3.3				
	$I_O = 20\ \text{mA}$	25°C	-1.5	-2.4		-1.5	-2.4			
		Full range	-1.4			-1.4				
$A_{VD}$ Large-signal differential voltage amplification	$V_O = \pm 2.3\ \text{V}$	$R_L = 600\ \Omega$	25°C	80	91		80	91	dB	
			Full range	78			78			
		$R_L = 2\ \text{k}\Omega$	25°C	90	100		90	100		
			Full range	88			88			
		$R_L = 10\ \text{k}\Omega$	25°C	95	106		95	106		
			Full range	93			93			
$r_i$ Input resistance	$V_{IC} = 0$	25°C	$10^{12}$			$10^{12}$			$\Omega$	
$c_i$ Input capacitance	$V_{IC} = 0, \text{See Figure 5}$	Common mode	25°C	11			11			pF
		Differential	25°C	2.5			2.5			
$z_o$ Open-loop output impedance	$f = 1\ \text{MHz}$	25°C	80			80			$\Omega$	
CMRR Common-mode rejection ratio	$V_{IC} = V_{ICR\text{min}}, V_O = 0, R_S = 50\ \Omega$	25°C	70	89		70	89	dB		
		Full range	68			68				
$k_{SVR}$ Supply-voltage rejection ratio ( $\Delta V_{CC\pm} / \Delta V_{IO}$ )	$V_{CC\pm} = \pm 5\ \text{V to } \pm 15\ \text{V}, V_O = 0, R_S = 50\ \Omega$	25°C	82	99		82	99	dB		
		Full range	80			80				
$I_{CC}$ Supply current (four amplifiers)	$V_O = 0, \text{No load}$	25°C	5.2	6.3	7.5	5.2	6.3	7.5	mA	
		Full range			7.5			7.5		
$a_x$ Crosstalk attenuation	$V_{IC} = 0, R_L = 2\ \text{k}\Omega$	25°C	120			120			dB	

\*On products compliant with MIL-PRF-38535, Class B, this parameter is not production tested.

† Full range is  $-55^\circ\text{C}$  to  $125^\circ\text{C}$ .



**TLE208x, TLE208xA, TLE208xY**  
**EXCALIBUR HIGH-SPEED JFET-INPUT**  
**OPERATIONAL AMPLIFIERS**

SLOS182B – FEBRUARY 1997 – REVISED JUNE 2001

**TLE2084M electrical characteristics at specified free-air temperature,  $V_{CC\pm} = \pm 5\text{ V}$  (unless otherwise noted) (continued)**

PARAMETER	TEST CONDITIONS	$T_A$	TLE2084M			TLE2084AM			UNIT	
			MIN	TYP	MAX	MIN	TYP	MAX		
$I_{OS}$	Short-circuit output current	$V_O = 0$	$V_{ID} = 1\text{ V}$	–35			–35			mA
			$V_{ID} = -1\text{ V}$	45			45			

**TLE2084M operating characteristics at specified free-air temperature,  $V_{CC\pm} = \pm 5\text{ V}$**

PARAMETER	TEST CONDITIONS	$T_A$ †	TLE2084M			TLE2084AM			UNIT	
			MIN	TYP	MAX	MIN	TYP	MAX		
SR+	Positive slew rate	$V_{O(PP)} = \pm 2.3\text{ V}$ , $A_{VD} = -1$ , $R_L = 2\text{ k}\Omega$ , $C_L = 100\text{ pF}$ , See Figure 1	25°C	35			35			V/ $\mu$ s
			Full range	18*			18*			
SR–	Negative slew rate	$V_{O(PP)} = \pm 2.3\text{ V}$ , $A_{VD} = -1$ , $R_L = 2\text{ k}\Omega$ , $C_L = 100\text{ pF}$ , See Figure 1	25°C	38			38			V/ $\mu$ s
			Full range	18*			18*			
$t_s$	Settling time	$A_{VD} = -1$ , 2-V step, $R_L = 1\text{ k}\Omega$ , $C_L = 100\text{ pF}$	To 10 mV	0.25			0.25			$\mu$ s
			To 1 mV	0.4			0.4			
$V_n$	Equivalent input noise voltage	$R_S = 20\ \Omega$ , See Figure 3	f = 10 Hz	28			28			nV/ $\sqrt{\text{Hz}}$
			f = 10 kHz	11.6			11.6			
$V_{N(PP)}$	Peak-to-peak equivalent input noise voltage	$R_S = 20\ \Omega$ , See Figure 3	f = 10 Hz to 10 kHz	6			6			$\mu$ V
			f = 0.1 Hz to 10 Hz	0.6			0.6			
$I_n$	Equivalent input noise current	$V_{IC} = 0$ , f = 10 kHz	25°C	2.8			2.8			fA/ $\sqrt{\text{Hz}}$
THD + N	Total harmonic distortion plus noise	$V_{O(PP)} = 5\text{ V}$ , $A_{VD} = 10$ , f = 1 kHz, $R_L = 2\text{ k}\Omega$ , $R_S = 25\ \Omega$	25°C	0.013%			0.013%			
$B_1$	Unity-gain bandwidth	$V_I = 10\text{ mV}$ , $R_L = 2\text{ k}\Omega$ , $C_L = 25\text{ pF}$ , See Figure 2	25°C	9.4			9.4			MHz
BOM	Maximum output-swing bandwidth	$V_{O(PP)} = 4\text{ V}$ , $A_{VD} = -1$ , $R_L = 2\text{ k}\Omega$ , $C_L = 25\text{ pF}$	25°C	2.8			2.8			MHz
$\phi_m$	Phase margin at unity gain	$V_I = 10\text{ mV}$ , $R_L = 2\text{ k}\Omega$ , $C_L = 25\text{ pF}$ , See Figure 2	25°C	56°			56°			

\*On products compliant with MIL-PRF-38535, Class B, this parameter is not production tested.

† Full range is –55°C to 125°C.





**TLE208x, TLE208xA, TLE208xY**  
**EXCALIBUR HIGH-SPEED JFET-INPUT**  
**OPERATIONAL AMPLIFIERS**

SLOS182B – FEBRUARY 1997 – REVISED JUNE 2001

**TLE2084M electrical characteristics at specified free-air temperature,  $V_{CC\pm} = \pm 15$  V (unless otherwise noted)**

PARAMETER	TEST CONDITIONS	$T_A$ †	TLE2084M			TLE2084AM			UNIT
			MIN	TYP	MAX	MIN	TYP	MAX	
$V_{IO}$ Input offset voltage	$V_{IC} = 0, V_O = 0, R_S = 50 \Omega$	25°C	-1.6	7		-0.5	4	mV	
		Full range			12.5		7.5		
$\alpha_{VIO}$ Temperature coefficient of input offset voltage		Full range	10.1	30*		10.1	30*	$\mu V/^\circ C$	
$I_{IO}$ Input offset current	$V_{IC} = 0, V_O = 0, \text{See Figure 4}$	25°C	15	100		15	100	pA	
		Full range			20		20	nA	
$I_{IB}$ Input bias current		25°C	25	175		25	175	pA	
		Full range			65		65	nA	
$V_{ICR}$ Common-mode input voltage range	$R_S = 50 \Omega$	25°C	15 to -11	15 to -11.9		15 to -11	15 to -11.9	V	
		Full range	15 to -10.8			15 to -10.8			
$V_{OM+}$ Maximum positive peak output voltage swing	$I_O = -200 \mu A$	25°C	13.8	14.1		13.8	14.1	V	
		Full range	13.6			13.6			
	$I_O = -2 \text{ mA}$	25°C	13.5	13.9		13.5	13.9		
		Full range	13.3			13.3			
	$I_O = -20 \text{ mA}$	25°C	11.5	12.3		11.5	12.3		
		Full range	11.4			11.4			
$V_{OM-}$ Maximum negative peak output voltage swing	$I_O = 200 \mu A$	25°C	-13.8	-14.2		-13.8	-14.2	V	
		Full range	-13.6			-13.6			
	$I_O = 2 \text{ mA}$	25°C	-13.5	-14		-13.5	-14		
		Full range	-13.3			-13.3			
	$I_O = 20 \text{ mA}$	25°C	-11.5	-12.4		-11.5	-12.4		
		Full range	-11.4			-11.4			
$A_{VD}$ Large-signal differential voltage amplification	$V_O = \pm 10 \text{ V}$	$R_L = 600 \Omega$	25°C	80	96		80	96	dB
			Full range	78			78		
		$R_L = 2 \text{ k}\Omega$	25°C	90	109		90	109	
			Full range	88			88		
		$R_L = 10 \text{ k}\Omega$	25°C	95	118		95	118	
			Full range	93			93		
$r_i$ Input resistance	$V_{IC} = 0$	25°C		$10^{12}$		$10^{12}$	$\Omega$		
$c_i$ Input capacitance	$V_{IC} = 0, \text{See Figure 5}$	Common mode	25°C	7.5		7.5	pF		
		Differential	25°C	2.5		2.5			
$z_o$ Open-loop output impedance	$f = 1 \text{ MHz}$	25°C		80		80	$\Omega$		
CMRR Common-mode rejection ratio	$V_{IC} = V_{ICRmin}, V_O = 0, R_S = 50 \Omega$	25°C	80	98		80	98	dB	
		Full range	78			78			
$k_{SVR}$ Supply-voltage rejection ratio ( $\Delta V_{CC\pm}/\Delta V_{IO}$ )	$V_{CC\pm} = \pm 5 \text{ V to } \pm 15 \text{ V}, V_O = 0, R_S = 50 \Omega$	25°C	82	99		82	99	dB	
		Full range	80			80			
$I_{CC}$ Supply current (four amplifiers)	$V_O = 0, \text{No load}$	25°C	5.2	6.5	7.5	5.2	6.5	7.5	mA
		Full range			7.5			7.5	
$a_x$ Crosstalk attenuation	$V_{IC} = 0, R_L = 2 \text{ k}\Omega$	25°C		120		120	dB		

\*On products compliant with MIL-PRF-38535, Class B, this parameter is not production tested.

† Full range is  $-55^\circ C$  to  $125^\circ C$ .



**TLE208x, TLE208xA, TLE208xY**  
**EXCALIBUR HIGH-SPEED JFET-INPUT**  
**OPERATIONAL AMPLIFIERS**

SLOS182B – FEBRUARY 1997 – REVISED JUNE 2001

**TLE2084M electrical characteristics at specified free-air temperature,  $V_{CC\pm} = \pm 15\text{ V}$  (unless otherwise noted) (continued)**

PARAMETER	TEST CONDITIONS	$T_A$	TLE2084M			TLE2084AM			UNIT
			MIN	TYP	MAX	MIN	TYP	MAX	
$I_{OS}$	Short-circuit output current $V_O = 0$	25°C	$V_{ID} = 1\text{ V}$			$V_{ID} = -1\text{ V}$			mA
			-30	-45		-30	-45		
			30	48		30	48		

**TLE2084M operating characteristics at specified free-air temperature,  $V_{CC\pm} = \pm 15\text{ V}$**

PARAMETER	TEST CONDITIONS	$T_A$ †	TLE2084M			TLE2084AM			UNIT
			MIN	TYP	MAX	MIN	TYP	MAX	
SR+	Positive slew rate	25°C	Full range			Full range			$V/\mu\text{s}$
			25	40		25	40		
SR-	Negative slew rate	25°C	Full range			Full range			$V/\mu\text{s}$
			30	45		30	45		
$t_s$	Settling time	25°C	To 10 mV			To 10 mV			$\mu\text{s}$
			To 1 mV			To 1 mV			
$V_n$	Equivalent input noise voltage	25°C	f = 10 Hz			f = 10 Hz			$\text{nV}/\sqrt{\text{Hz}}$
			f = 10 kHz			f = 10 kHz			
$V_{N(PP)}$	Peak-to-peak equivalent input noise voltage	25°C	f = 10 Hz to 10 kHz			f = 10 Hz to 10 kHz			$\mu\text{V}$
			f = 0.1 Hz to 10 Hz			f = 0.1 Hz to 10 Hz			
$I_n$	Equivalent input noise current	25°C	f = 10 kHz			f = 10 kHz			$\text{fA}/\sqrt{\text{Hz}}$
THD + N	Total harmonic distortion plus noise	25°C	0.008%			0.008%			
$B_1$	Unity-gain bandwidth	25°C	8*	10		8*	10	MHz	
$B_{OM}$	Maximum output-swing bandwidth	25°C	478*	637		478*	637	kHz	
$\phi_m$	Phase margin at unity gain	25°C	57°			57°			

\*On products compliant with MIL-PRF-38535, Class B, this parameter is not production tested.

† Full range is -55°C to 125°C.



**TLE208x, TLE208xA, TLE208xY**  
**EXCALIBUR HIGH-SPEED JFET-INPUT**  
**OPERATIONAL AMPLIFIERS**

SLOS182B – FEBRUARY 1997 – REVISED JUNE 2001

**TLE2084Y electrical characteristics at  $V_{CC\pm} = \pm 15\text{ V}$ ,  $T_A = 25^\circ\text{C}$  (unless otherwise noted)**

PARAMETER		TEST CONDITIONS		TLE2084Y			UNIT
				MIN	TYP	MAX	
$V_{IO}$	Input offset voltage	$V_{IC} = 0$ , $R_S = 50\ \Omega$	$V_O = 0$ ,			7	mV
$I_{IO}$	Input offset current	$V_{IC} = 0$ ,	$V_O = 0$ ,		15	100	pA
$I_{IB}$	Input bias current	See Figure 4			25	175	pA
$V_{ICR}$	Common-mode input voltage range	$R_S = 50\ \Omega$		15 to -11	15 to 11.9		V
$V_{OM+}$	Maximum positive peak output voltage swing	$I_O = -200\ \mu\text{A}$		13.8	14.1		V
		$I_O = -2\ \text{mA}$		13.5	13.9		
		$I_O = -20\ \text{mA}$		11.5	12.3		
$V_{OM-}$	Maximum negative peak output voltage swing	$I_O = 200\ \mu\text{A}$		-13.8	-14.2		V
		$I_O = 2\ \text{mA}$		-13.5	-14		
		$I_O = 20\ \text{mA}$		-11.5	-12.4		
$A_{VD}$	Large-signal differential voltage amplification	$V_O = \pm 10\ \text{V}$	$R_L = 600\ \Omega$	80	96		dB
			$R_L = 2\ \text{k}\Omega$	90	109		
			$R_L = 10\ \text{k}\Omega$	95	118		
$r_i$	Input resistance	$V_{IC} = 0$		10 <sup>12</sup>			$\Omega$
$c_i$	Input capacitance	$V_{IC} = 0$ , See Figure 5	Common mode	7.5			pF
			Differential	2.5			
$z_o$	Open-loop output impedance	$f = 1\ \text{MHz}$		80			$\Omega$
CMRR	Common-mode rejection ratio	$V_{IC} = V_{ICRmin}$ , $R_S = 50\ \Omega$	$V_O = 0$ ,	80	98		dB
$k_{SVR}$	Supply-voltage rejection ratio ( $\Delta V_{CC\pm} / \Delta V_{IO}$ )	$V_{CC\pm} = \pm 5\ \text{V}$ to $\pm 15\ \text{V}$ , $V_O = 0$ , $R_S = 50\ \Omega$		82	99		dB
$I_{CC}$	Supply current (four amplifiers)	$V_O = 0$ ,	No load	5.2	6.5	7.5	mA
$I_{OS}$	Short-circuit output current	$V_O = 0$	$V_{ID} = 1\ \text{V}$	-30	-45		mA
			$V_{ID} = -1\ \text{V}$	30	48		

# TLE208x, TLE208xA, TLE208xY EXCALIBUR HIGH-SPEED JFET-INPUT OPERATIONAL AMPLIFIERS

SLOS182B – FEBRUARY 1997 – REVISED JUNE 2001

## PARAMETER MEASUREMENT INFORMATION

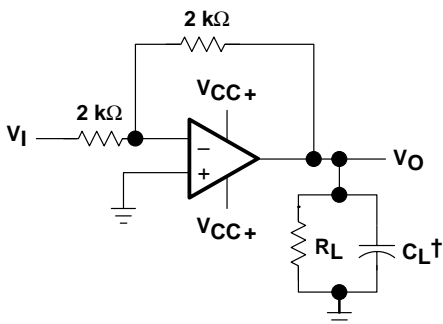

† Includes fixture capacitance

**Figure 1. Slew-Rate Test Circuit**



† Includes fixture capacitance

**Figure 2. Unity-Gain Bandwidth and Phase-Margin Test Circuit**

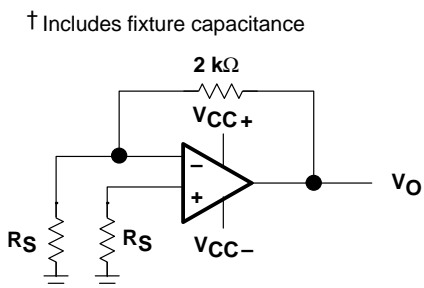

† Includes fixture capacitance

**Figure 3. Noise-Voltage Test Circuit**

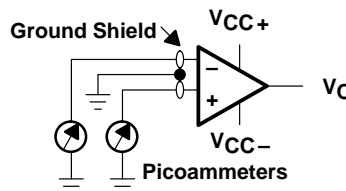

**Figure 4. Input-Bias and Offset-Current Test Circuit**

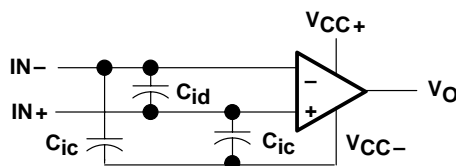

**Figure 5. Internal Input Capacitance**

### typical values

Typical values presented in this data sheet represent the median (50% point) of device parametric performance.

### input bias and offset current

At the picoampere bias-current level typical of the TLE208x and TLE208xA, accurate measurement of the bias becomes difficult. Not only does this measurement require a picoammeter, but test socket leakages can easily exceed the actual device bias currents. To accurately measure these small currents, Texas Instruments uses a two-step process. The socket leakage is measured using picoammeters with bias voltages applied but with no device in the socket. The device is then inserted in the socket and a second test is performed that measures both the socket leakage and the device input bias current. The two measurements are then subtracted algebraically to determine the bias current of the device.

## TYPICAL CHARACTERISTICS

**Table of Graphs**

			FIGURE
$V_{IO}$	Input offset voltage	Distribution	6, 7, 8
$\alpha_{VIO}$	Input offset voltage temperature coefficient	Distribution	9, 10, 11
$I_{IO}$	Input offset current	vs Free-air temperature	12 – 15
$I_{IB}$	Input bias current	vs Free-air temperature vs Supply voltage	12 – 15 16
$V_{ICR}$	Common-mode input voltage range	vs Free-air temperature	17
$V_{ID}$	Differential input voltage	vs Output voltage	18, 19
$V_{OM+}$	Maximum positive peak output voltage	vs Output current vs Free-air temperature vs Supply voltage	20, 21 24, 25 26
$V_{OM-}$	Maximum negative peak output voltage	vs Output current vs Free-air temperature vs Supply voltage	22, 23 24, 25 26
$V_{O(PP)}$	Maximum peak-to-peak output voltage	vs Frequency	27
$V_O$	Output voltage	vs Settling time	28
$A_{VD}$	Large-signal differential voltage amplification	vs Load resistance vs Free-air temperature	29 30, 31
$A_{VD}$	Small-signal differential voltage amplification	vs Frequency	32, 33
$CMRR$	Common-mode rejection ratio	vs Frequency vs Free-air temperature	34 35
$k_{SVR}$	Supply-voltage rejection ratio	vs Frequency vs Free-air temperature	36 37
$I_{CC}$	Supply current	vs Supply voltage vs Free-air temperature vs Differential input voltage	38, 39, 40 41, 42, 43 44 – 49
$I_{OS}$	Short-circuit output current	vs Supply voltage vs Elapsed time vs Free-air temperature	50 51 52
$SR$	Slew rate	vs Free-air temperature vs Load resistance vs Differential input voltage	53, 54 55 56
$V_n$	Equivalent input noise voltage	vs Frequency	57
$V_n$	Input-referred noise voltage	vs Noise bandwidth frequency Over a 10-second time interval	58 59
	Third-octave spectral noise density	vs Frequency bands	60
$THD + N$	Total harmonic distortion plus noise	vs Frequency	61, 62
$B_1$	Unity-gain bandwidth	vs Load capacitance	63
	Gain-bandwidth product	vs Free-air temperature vs Supply voltage	64 65
	Gain margin	vs Load capacitance	66
$\phi_m$	Phase margin	vs Free-air temperature vs Supply voltage vs Load capacitance	67 68 69
	Phase shift	vs Frequency	32, 33

**TLE208x, TLE208xA, TLE208xY**  
**EXCALIBUR HIGH-SPEED JFET-INPUT**  
**OPERATIONAL AMPLIFIERS**

SLOS182B – FEBRUARY 1997 – REVISED JUNE 2001

**TYPICAL CHARACTERISTICS**

**Table of Graphs (Continued)**

		FIGURE
Noninverting large-signal pulse response	vs Time	70
Small-signal pulse response	vs Time	71
$z_o$	Closed-loop output impedance vs Frequency	72
$a_x$	Crosstalk attenuation vs Frequency	73

**DISTRIBUTION OF TLE2081  
INPUT OFFSET VOLTAGE**

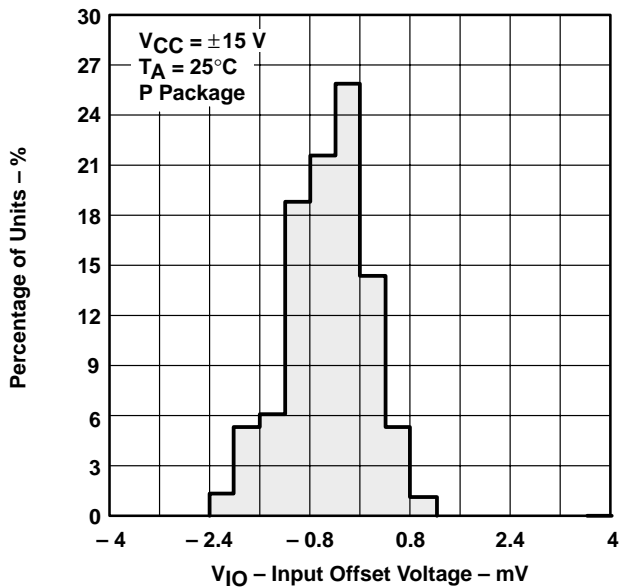

**Figure 6**

**DISTRIBUTION OF TLE2082  
INPUT OFFSET VOLTAGE**

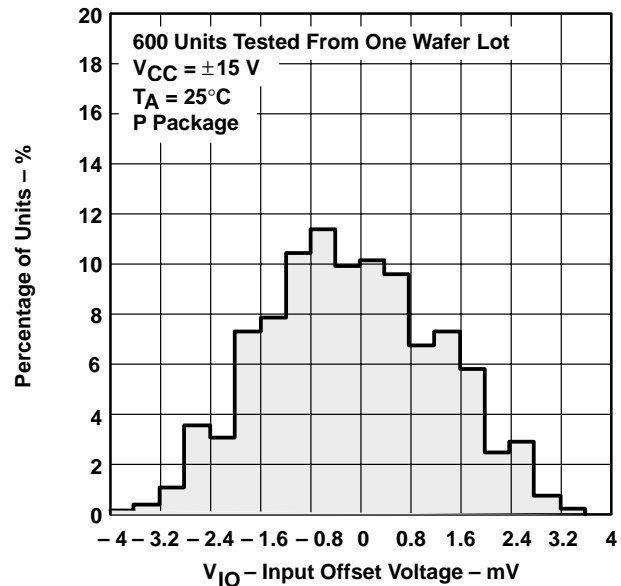

**Figure 7**

TYPICAL CHARACTERISTICS

DISTRIBUTION OF TLE2084  
INPUT OFFSET VOLTAGE



Figure 8

DISTRIBUTION OF TLE2081 INPUT OFFSET  
VOLTAGE TEMPERATURE COEFFICIENT



Figure 9

DISTRIBUTION OF TLE2082 INPUT OFFSET  
VOLTAGE TEMPERATURE COEFFICIENT

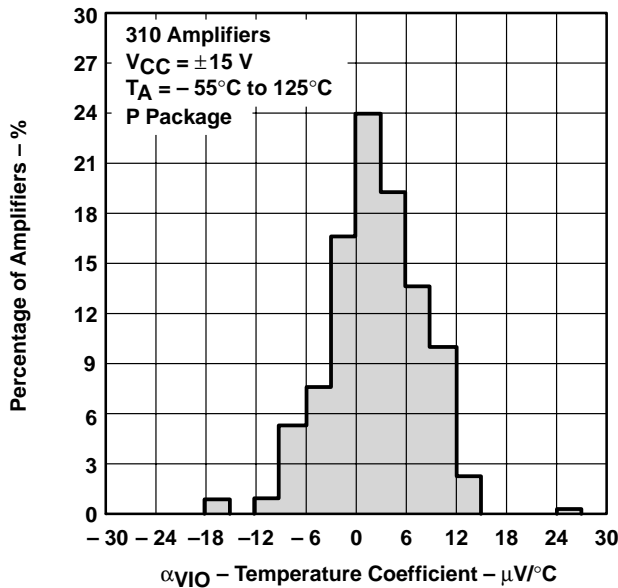

Figure 10

DISTRIBUTION OF TLE2084 INPUT OFFSET  
VOLTAGE TEMPERATURE COEFFICIENT



Figure 11

# TLE208x, TLE208xA, TLE208xY EXCALIBUR HIGH-SPEED JFET-INPUT OPERATIONAL AMPLIFIERS

SLOS182B – FEBRUARY 1997 – REVISED JUNE 2001

## TYPICAL CHARACTERISTICS†

**TLE2081 AND TLE2082**  
INPUT BIAS CURRENT AND INPUT OFFSET CURRENT  
vs  
FREE-AIR TEMPERATURE

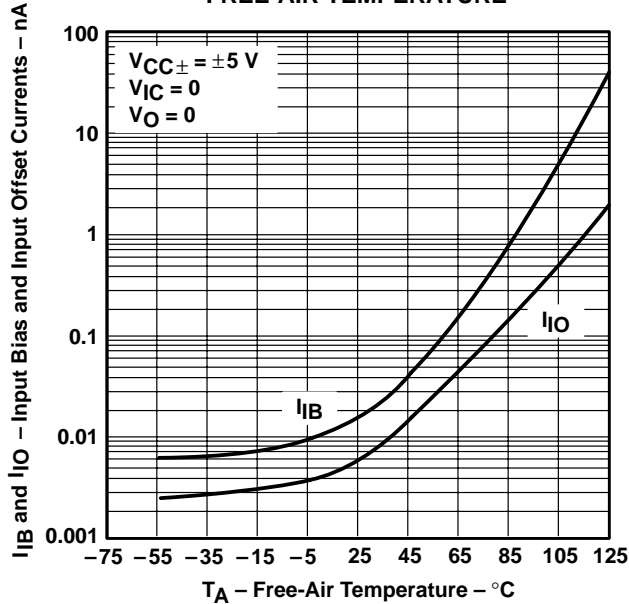

Figure 12

**TLE2084**  
INPUT BIAS CURRENT AND INPUT OFFSET CURRENT  
vs  
FREE-AIR TEMPERATURE

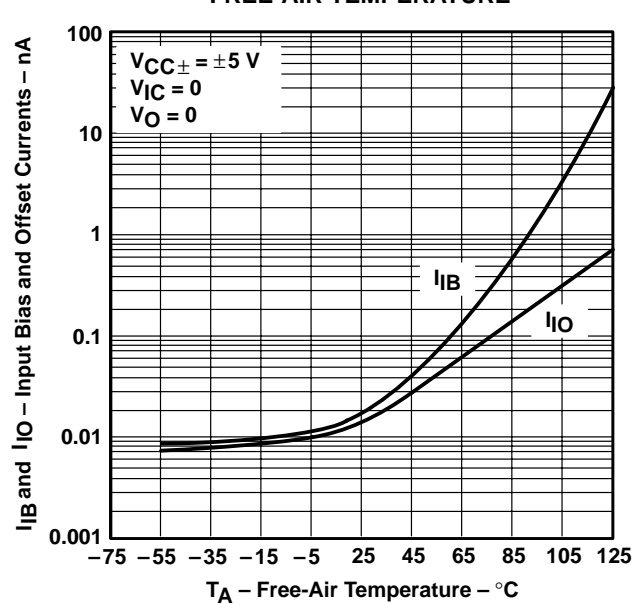

Figure 13

**TLE2081 AND TLE2082**  
INPUT BIAS CURRENT AND INPUT OFFSET CURRENT  
vs  
FREE-AIR TEMPERATURE

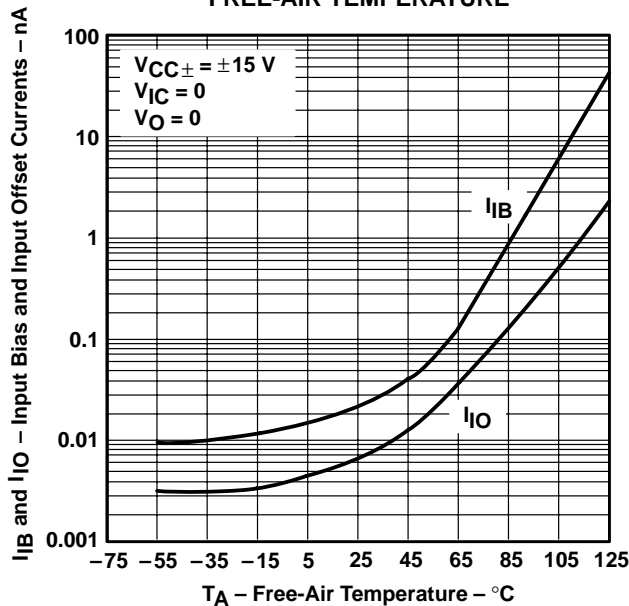

Figure 14

**TLE2084**  
INPUT BIAS CURRENT AND INPUT OFFSET CURRENT  
vs  
FREE-AIR TEMPERATURE

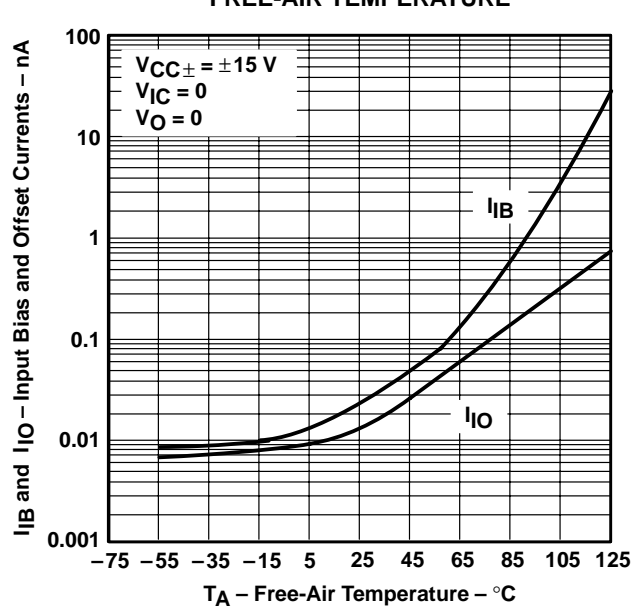
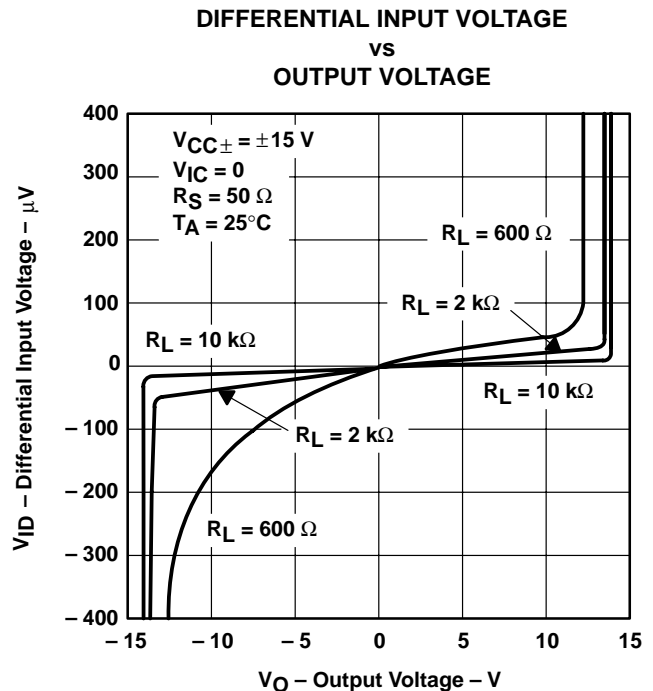
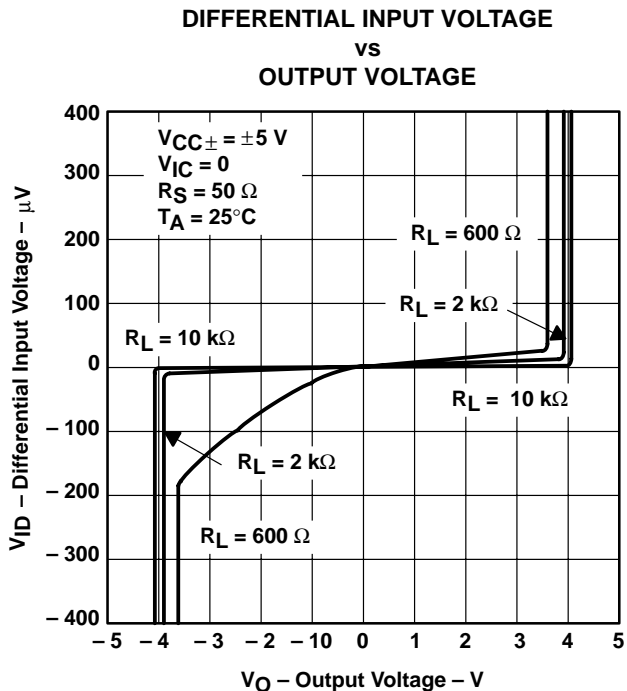
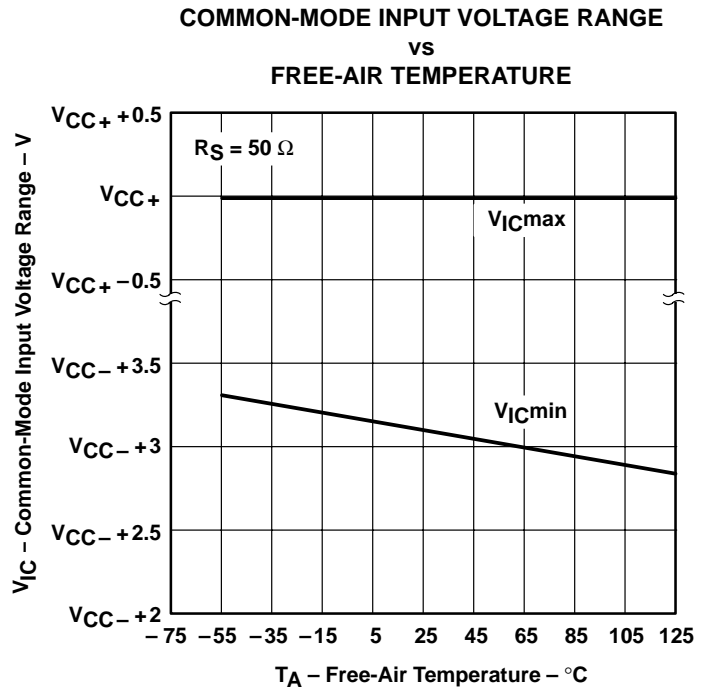
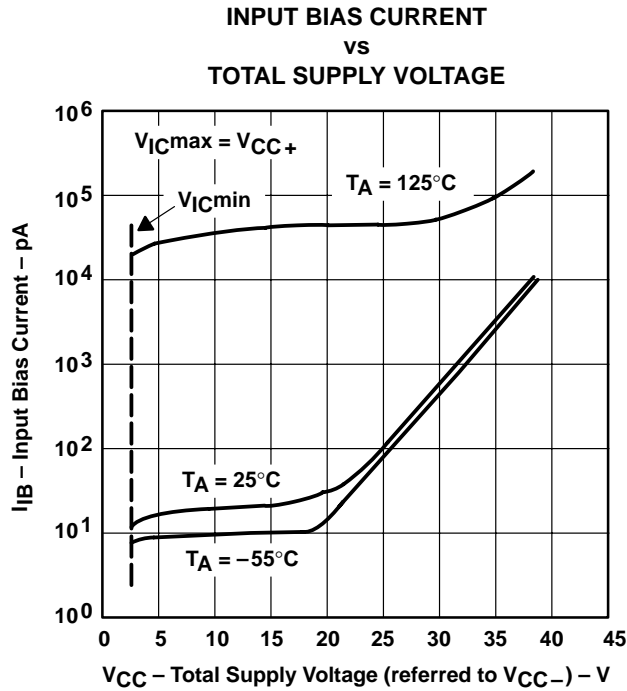

Figure 15

† Data at high and low temperatures are applicable only within the rated operating free-air temperature ranges of the various devices.



TYPICAL CHARACTERISTICS†



† Data at high and low temperatures are applicable only within the rated operating free-air temperature ranges of the various devices.

# TLE208x, TLE208xA, TLE208xY EXCALIBUR HIGH-SPEED JFET-INPUT OPERATIONAL AMPLIFIERS

SLOS182B – FEBRUARY 1997 – REVISED JUNE 2001

## TYPICAL CHARACTERISTICS†

**TLE2081 AND TLE2082  
MAXIMUM POSITIVE PEAK OUTPUT VOLTAGE  
vs  
OUTPUT CURRENT**

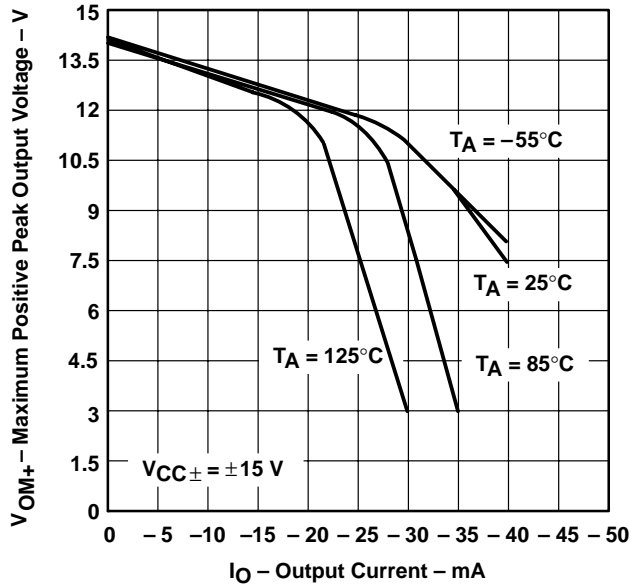

**Figure 20**

**TLE2084  
MAXIMUM POSITIVE PEAK OUTPUT VOLTAGE  
vs  
OUTPUT CURRENT**

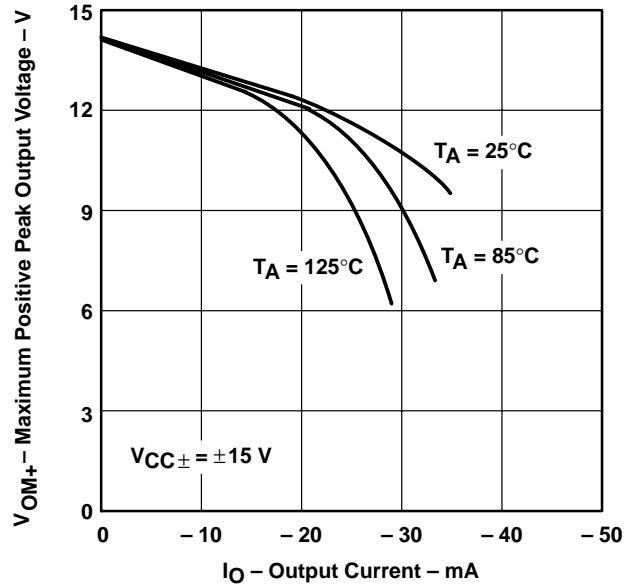

**Figure 21**

**TLE2081 AND TLE2082  
MAXIMUM NEGATIVE PEAK OUTPUT VOLTAGE  
vs  
OUTPUT CURRENT**

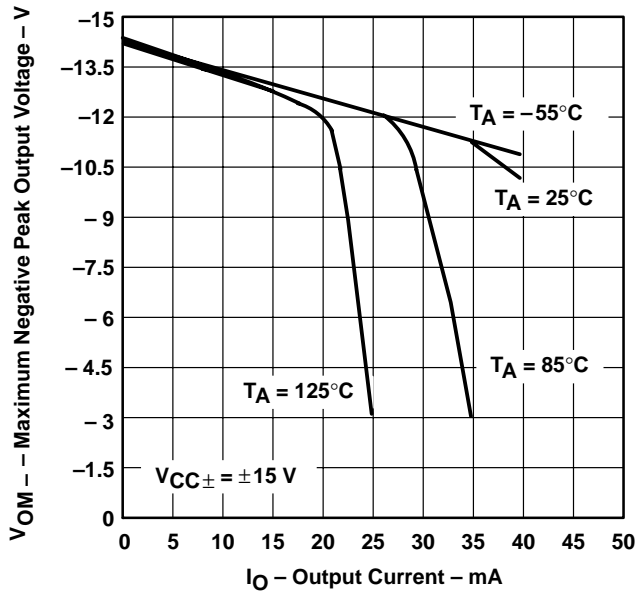

**Figure 22**

**TLE2084  
MAXIMUM NEGATIVE PEAK OUTPUT VOLTAGE  
vs  
OUTPUT CURRENT**

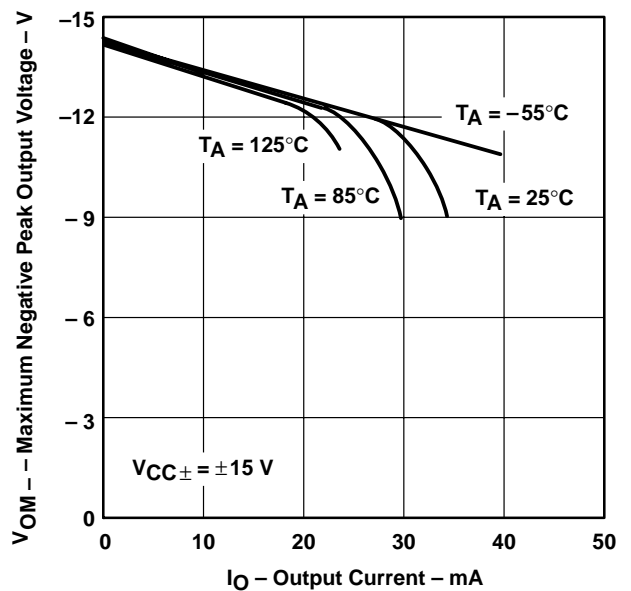

**Figure 23**

† Data at high and low temperatures are applicable only within the rated operating free-air temperature ranges of the various devices.

TYPICAL CHARACTERISTICS†

MAXIMUM PEAK OUTPUT VOLTAGE  
vs  
FREE-AIR TEMPERATURE

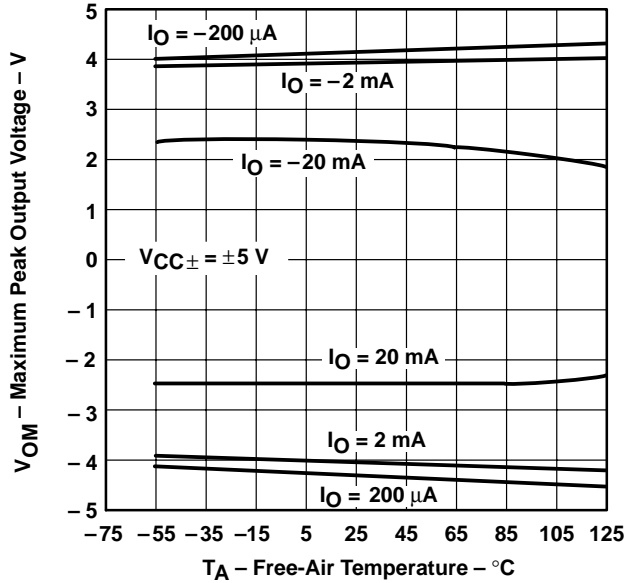

Figure 24

MAXIMUM PEAK OUTPUT VOLTAGE  
vs  
FREE-AIR TEMPERATURE

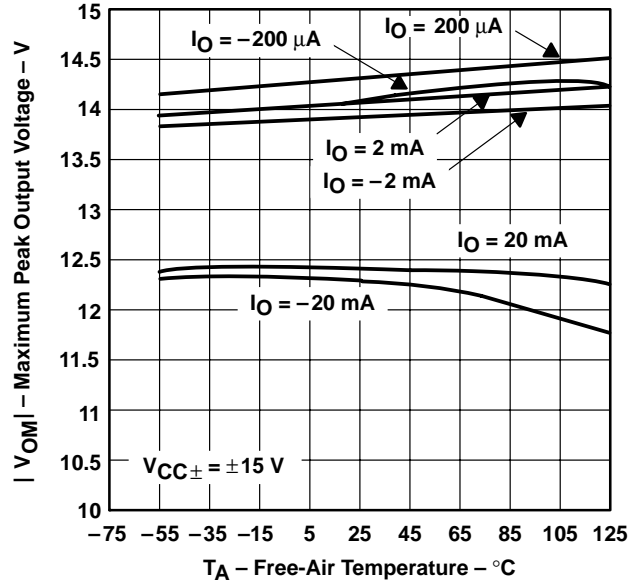

Figure 25

MAXIMUM PEAK OUTPUT VOLTAGE  
vs  
SUPPLY VOLTAGE



Figure 26

MAXIMUM PEAK-TO-PEAK OUTPUT VOLTAGE  
vs  
FREQUENCY

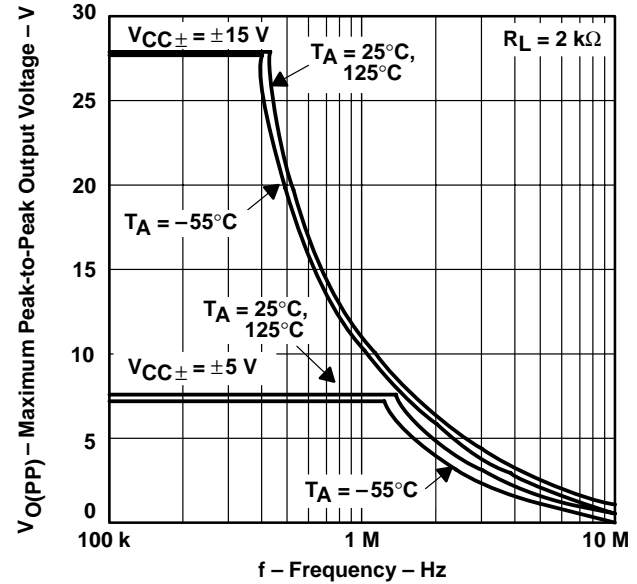

Figure 27

† Data at high and low temperatures are applicable only within the rated operating free-air temperature ranges of the various devices.

# TLE208x, TLE208xA, TLE208xY EXCALIBUR HIGH-SPEED JFET-INPUT OPERATIONAL AMPLIFIERS

SLOS182B – FEBRUARY 1997 – REVISED JUNE 2001

## TYPICAL CHARACTERISTICS†

OUTPUT VOLTAGE  
vs  
SETTLING TIME

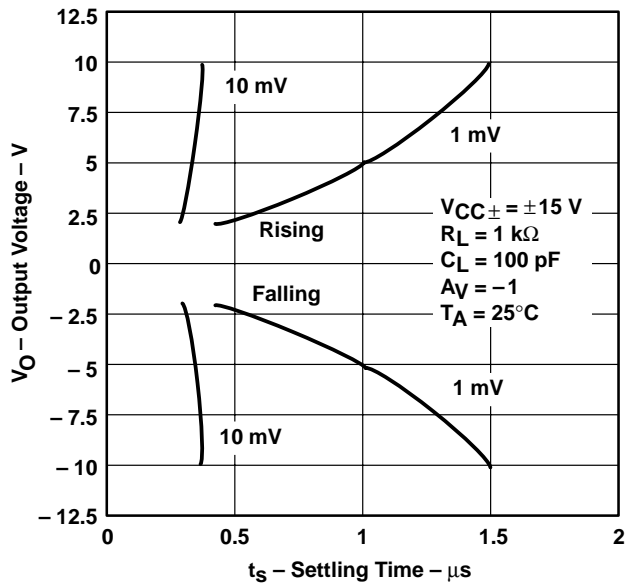

Figure 28

LARGE-SIGNAL DIFFERENTIAL  
VOLTAGE AMPLIFICATION  
vs  
LOAD RESISTANCE

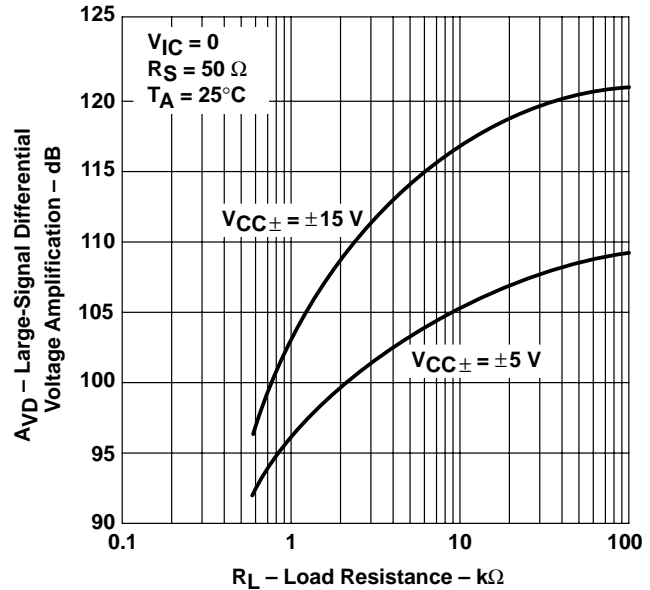

Figure 29

LARGE-SIGNAL DIFFERENTIAL  
VOLTAGE AMPLIFICATION  
vs  
FREE-AIR TEMPERATURE

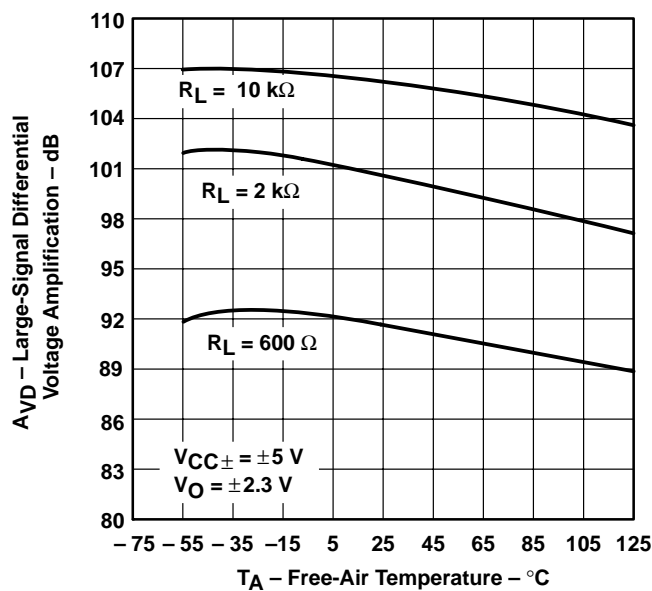

Figure 30

LARGE-SIGNAL DIFFERENTIAL  
VOLTAGE AMPLIFICATION  
vs  
FREE-AIR TEMPERATURE

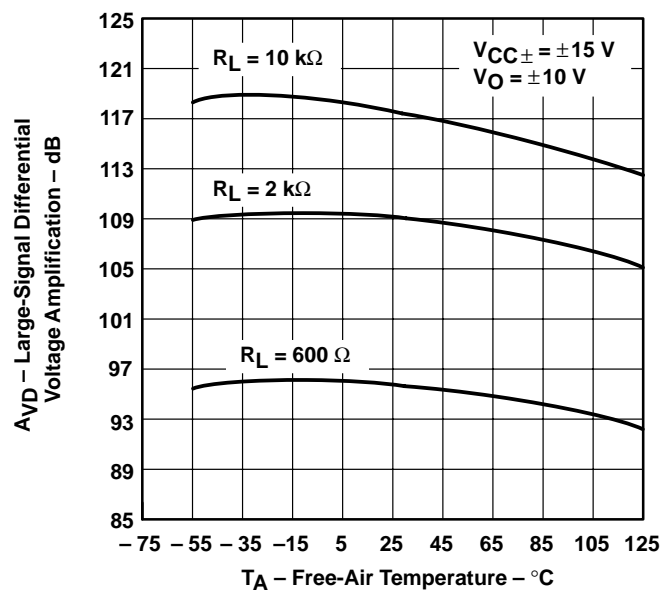

Figure 31

† Data at high and low temperatures are applicable only within the rated operating free-air temperature ranges of the various devices.

TYPICAL CHARACTERISTICS

SMALL-SIGNAL DIFFERENTIAL VOLTAGE  
 AMPLIFICATION AND PHASE SHIFT  
 vs  
 FREQUENCY

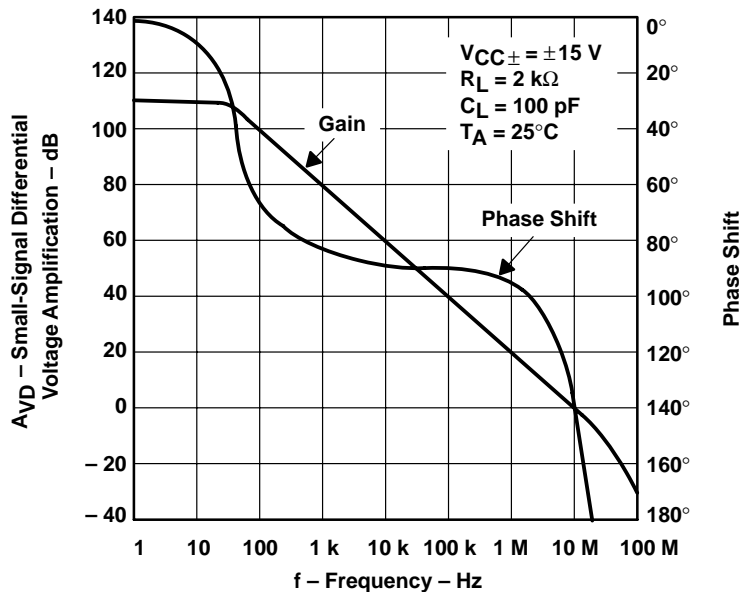

Figure 32

SMALL-SIGNAL DIFFERENTIAL VOLTAGE  
 AMPLIFICATION AND PHASE SHIFT  
 vs  
 FREQUENCY

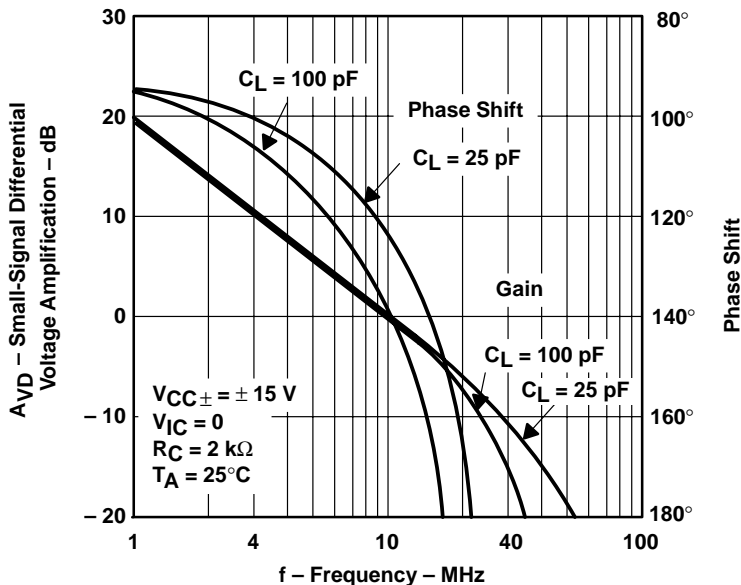

Figure 33

# TLE208x, TLE208xA, TLE208xY EXCALIBUR HIGH-SPEED JFET-INPUT OPERATIONAL AMPLIFIERS

SLOS182B – FEBRUARY 1997 – REVISED JUNE 2001

## TYPICAL CHARACTERISTICS†



Figure 34



Figure 35



Figure 36



Figure 37

† Data at high and low temperatures are applicable only within the rated operating free-air temperature ranges of the various devices.

TYPICAL CHARACTERISTICS†



† Data at high and low temperatures are applicable only within the rated operating free-air temperature ranges of the various devices.

# TLE208x, TLE208xA, TLE208xY EXCALIBUR HIGH-SPEED JFET-INPUT OPERATIONAL AMPLIFIERS

SLOS182B – FEBRUARY 1997 – REVISED JUNE 2001

## TYPICAL CHARACTERISTICS†

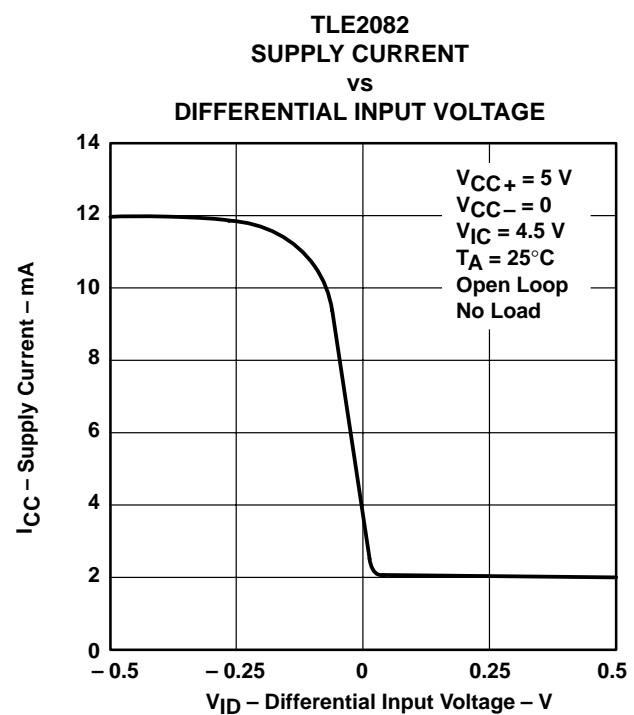
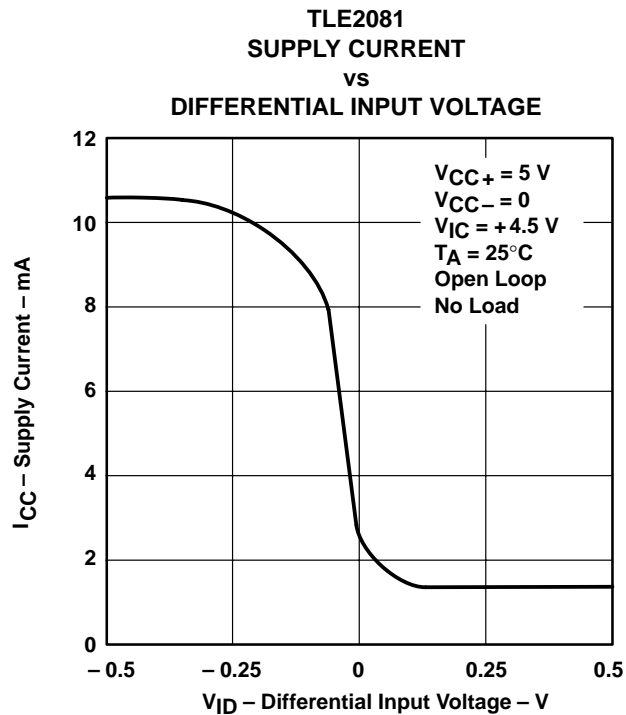
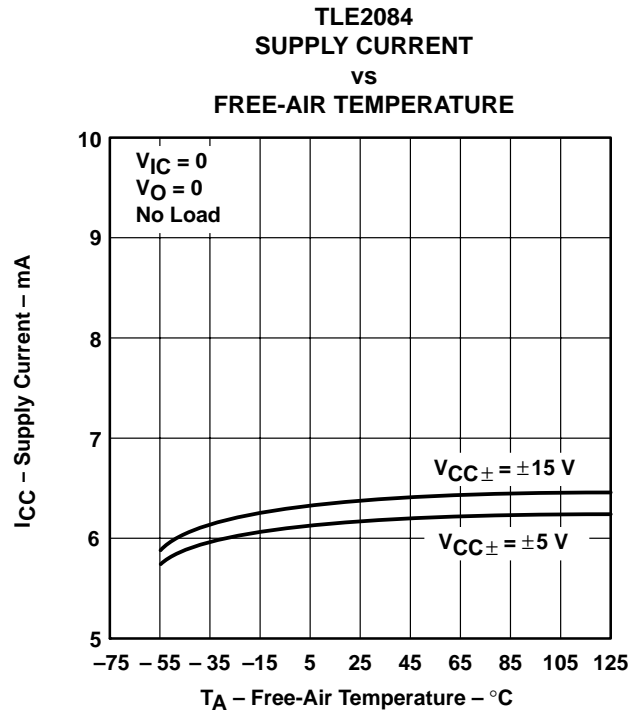

† Data at high and low temperatures are applicable only within the rated operating free-air temperature ranges of the various devices.



TYPICAL CHARACTERISTICS

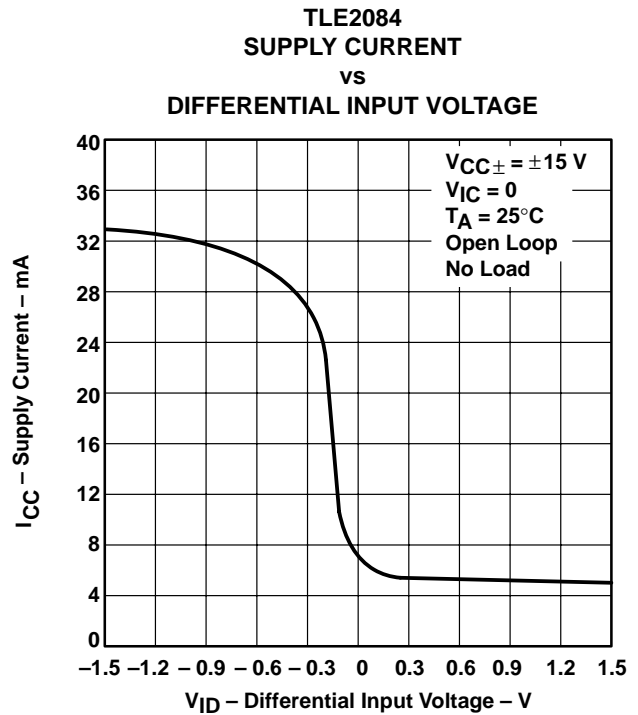
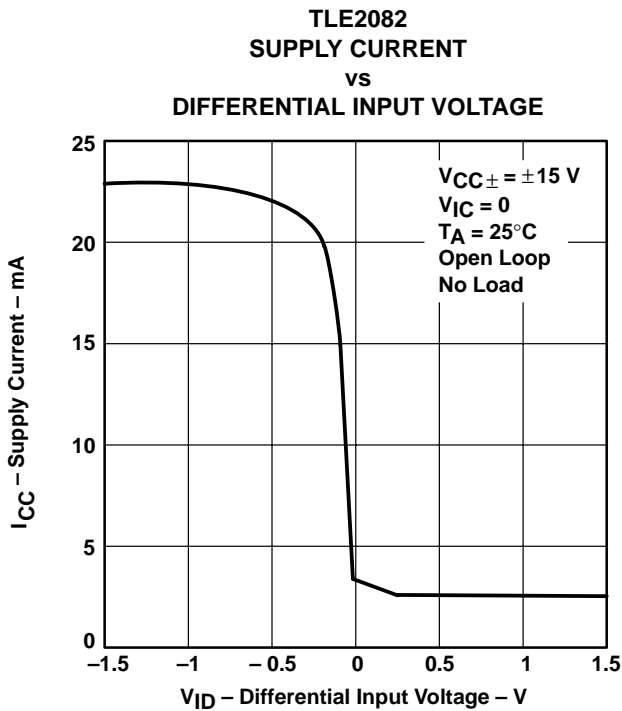
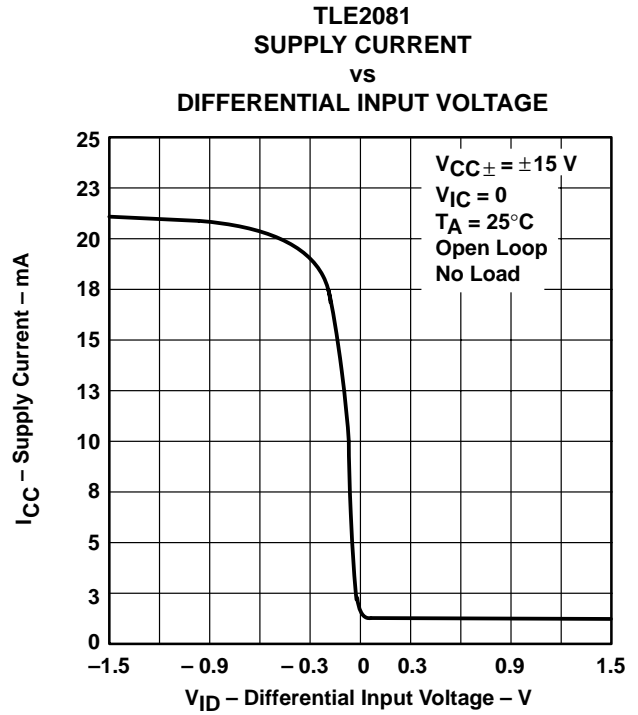

# TLE208x, TLE208xA, TLE208xY EXCALIBUR HIGH-SPEED JFET-INPUT OPERATIONAL AMPLIFIERS

SLOS182B – FEBRUARY 1997 – REVISED JUNE 2001

## TYPICAL CHARACTERISTICS†

SHORT-CIRCUIT OUTPUT CURRENT  
vs  
SUPPLY VOLTAGE

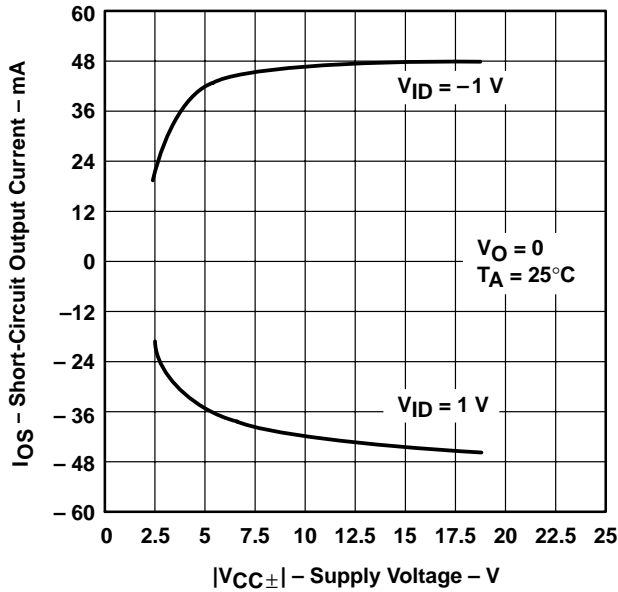

Figure 50

SHORT-CIRCUIT OUTPUT CURRENT  
vs  
ELAPSED TIME

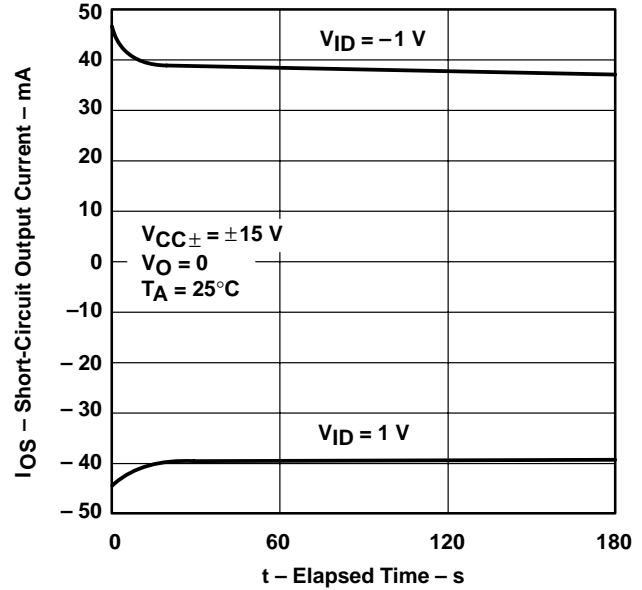

Figure 51

SHORT-CIRCUIT OUTPUT CURRENT  
vs  
FREE-AIR TEMPERATURE

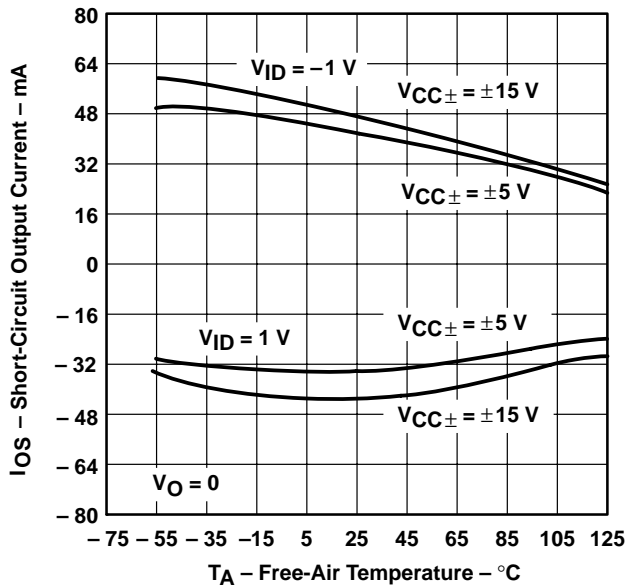

Figure 52

SLEW RATE  
vs  
FREE-AIR TEMPERATURE

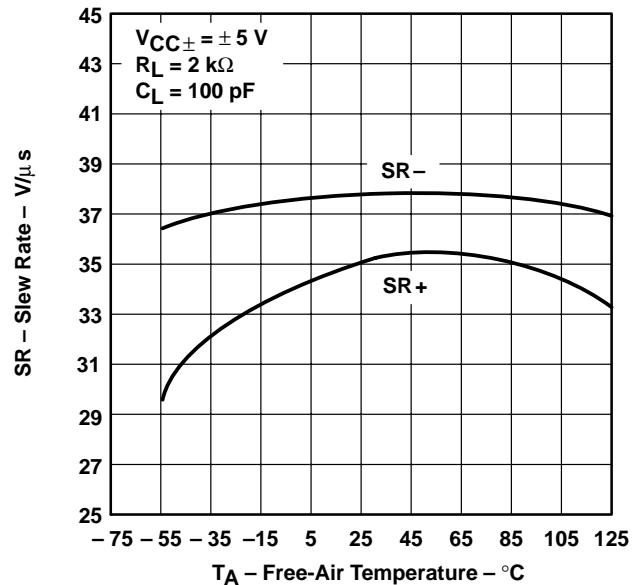

Figure 53

† Data at high and low temperatures are applicable only within the rated operating free-air temperature ranges of the various devices.

TYPICAL CHARACTERISTICS†

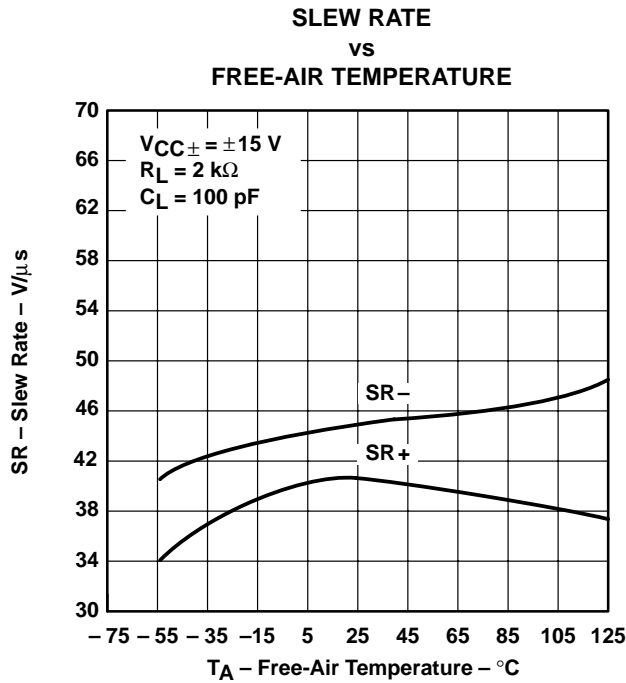

Figure 54

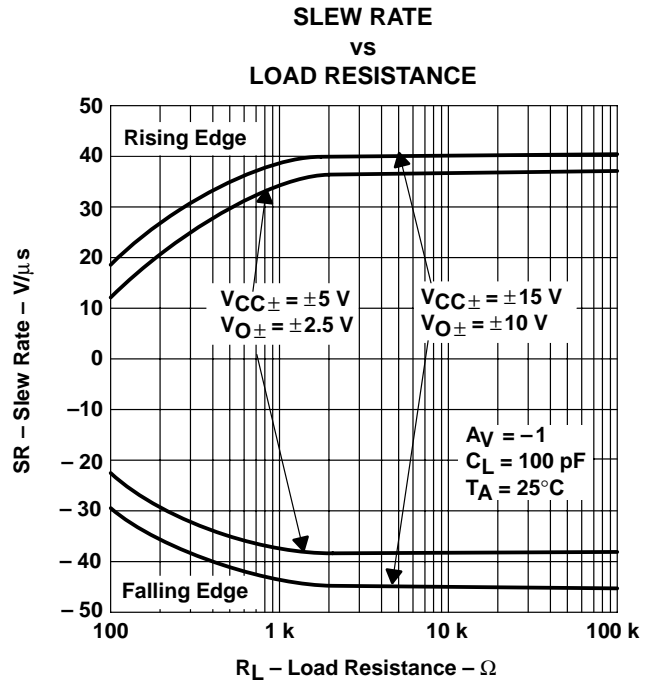

Figure 55

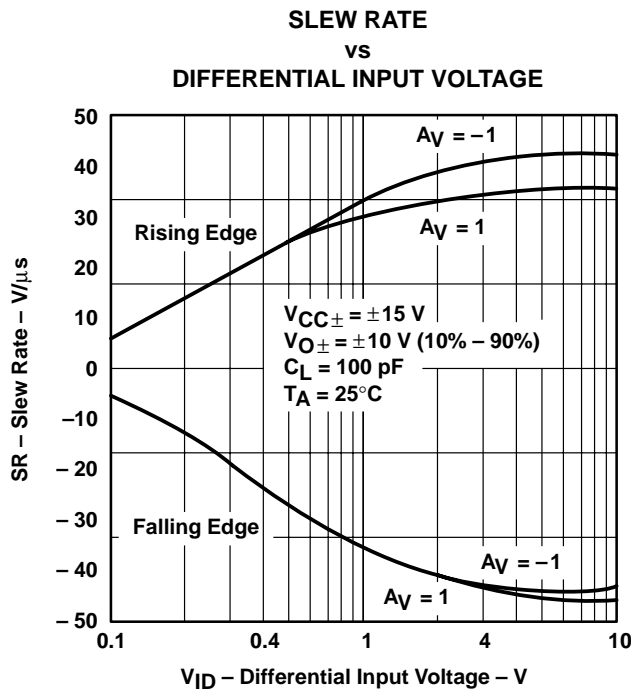

Figure 56

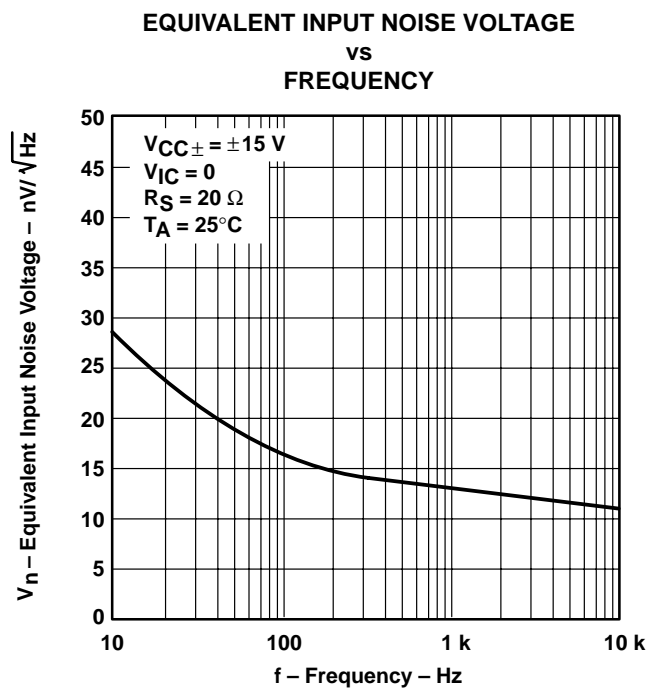

Figure 57

† Data at high and low temperatures are applicable only within the rated operating free-air temperature ranges of the various devices.

**TLE208x, TLE208xA, TLE208xY**  
**EXCALIBUR HIGH-SPEED JFET-INPUT**  
**OPERATIONAL AMPLIFIERS**

SLOS182B – FEBRUARY 1997 – REVISED JUNE 2001

**TYPICAL CHARACTERISTICS**

**INPUT-REFERRED NOISE VOLTAGE**  
**vs**  
**NOISE BANDWIDTH FREQUENCY**

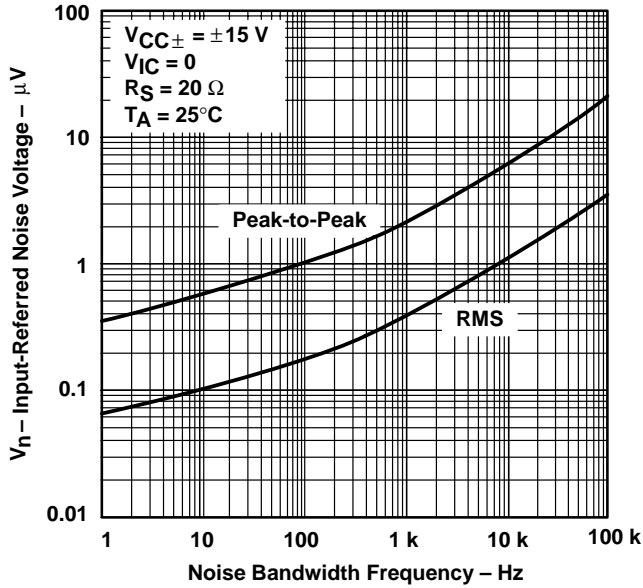

**Figure 58**

**INPUT-REFERRED NOISE VOLTAGE**  
**OVER A 10-SECOND TIME INTERVAL**

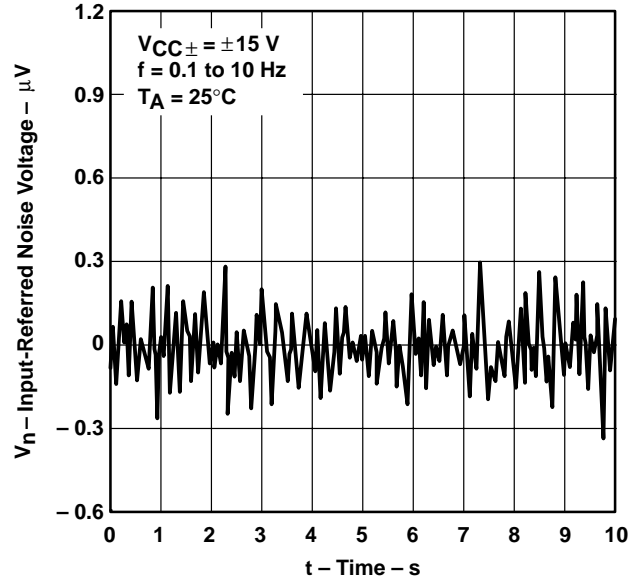

**Figure 59**

**THIRD-OCTAVE SPECTRAL NOISE DENSITY**  
**vs**  
**FREQUENCY BANDS**

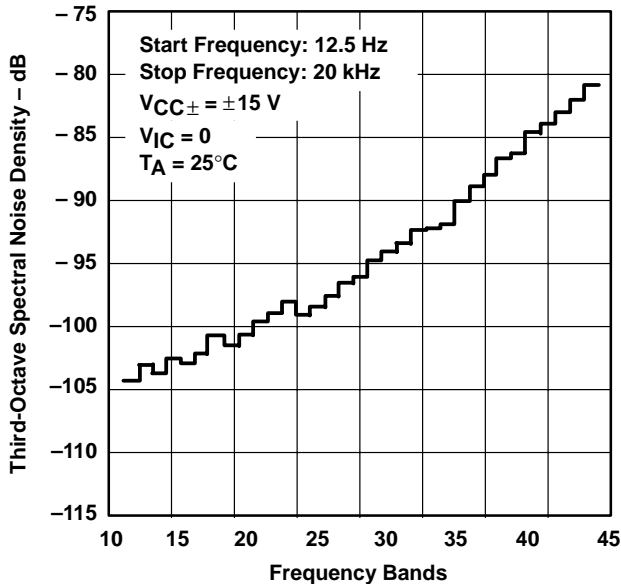

**Figure 60**

**TOTAL HARMONIC DISTORTION PLUS NOISE**  
**vs**  
**FREQUENCY**

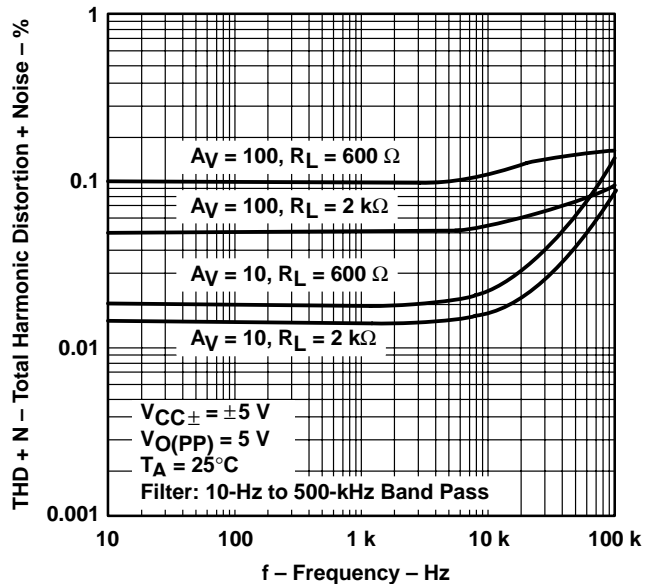

**Figure 61**



TYPICAL CHARACTERISTICS†

TOTAL HARMONIC DISTORTION PLUS NOISE  
vs  
FREQUENCY

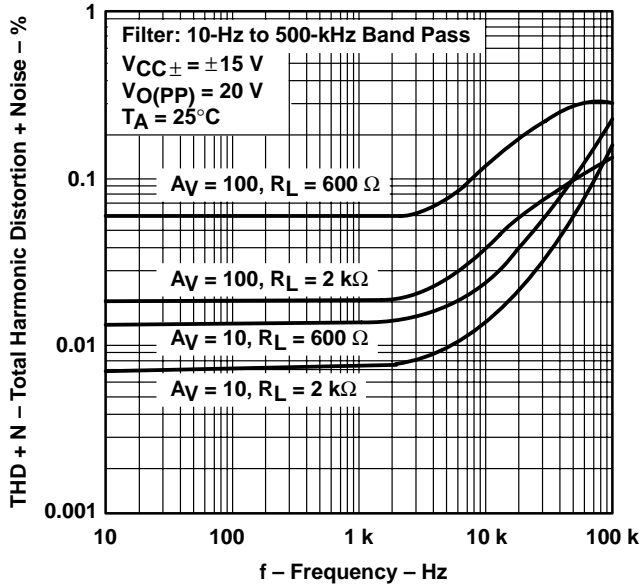

Figure 62

UNITY-GAIN BANDWIDTH  
vs  
LOAD CAPACITANCE

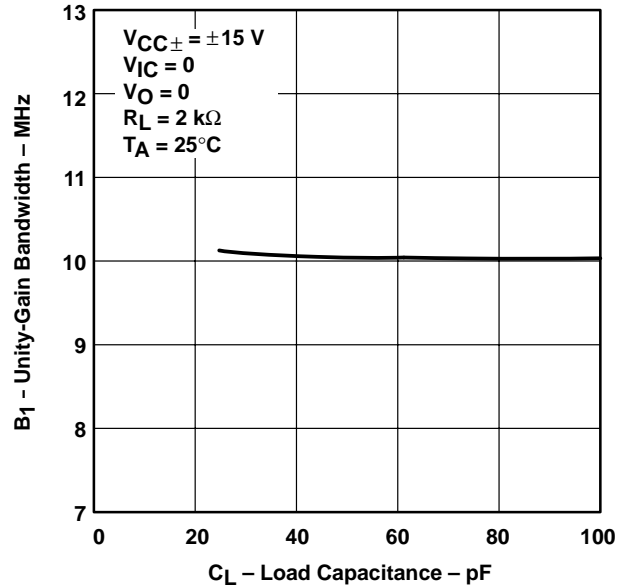

Figure 63

GAIN-BANDWIDTH PRODUCT  
vs  
FREE-AIR TEMPERATURE

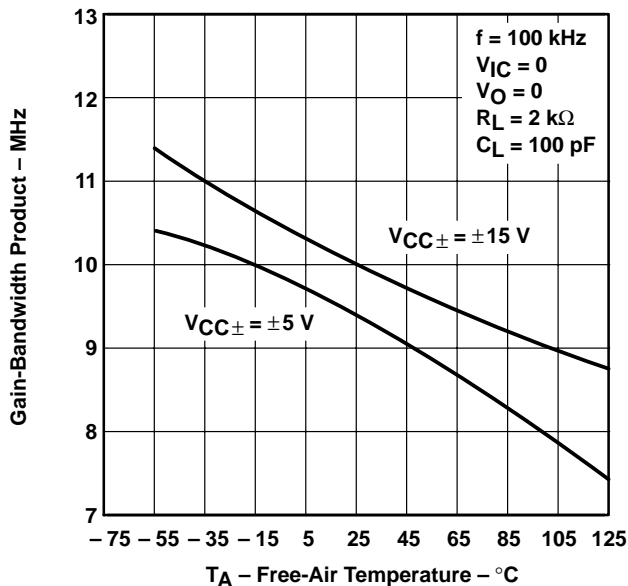

Figure 64

GAIN-BANDWIDTH PRODUCT  
vs  
SUPPLY VOLTAGE

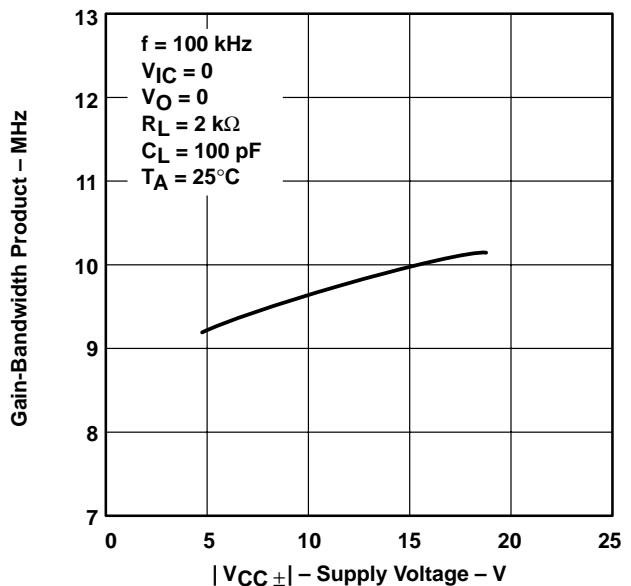

Figure 65

† Data at high and low temperatures are applicable only within the rated operating free-air temperature ranges of the various devices.

# TLE208x, TLE208xA, TLE208xY EXCALIBUR HIGH-SPEED JFET-INPUT OPERATIONAL AMPLIFIERS

SLOS182B – FEBRUARY 1997 – REVISED JUNE 2001

## TYPICAL CHARACTERISTICS†

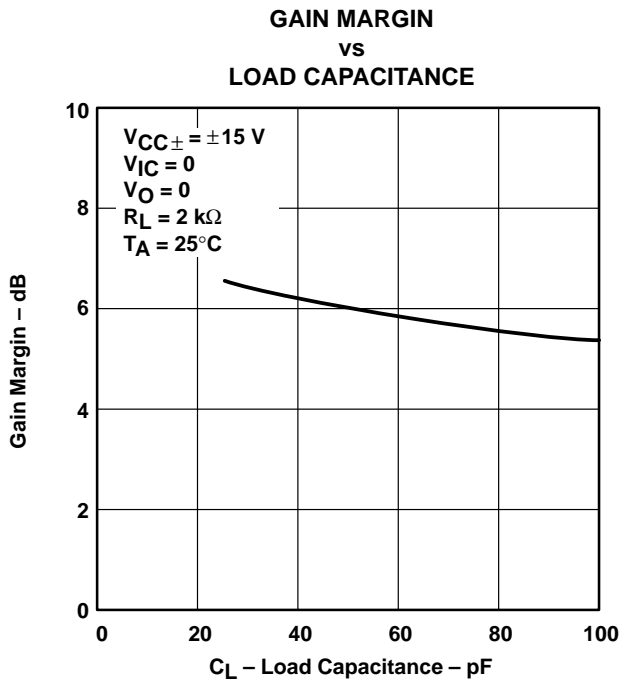

Figure 66

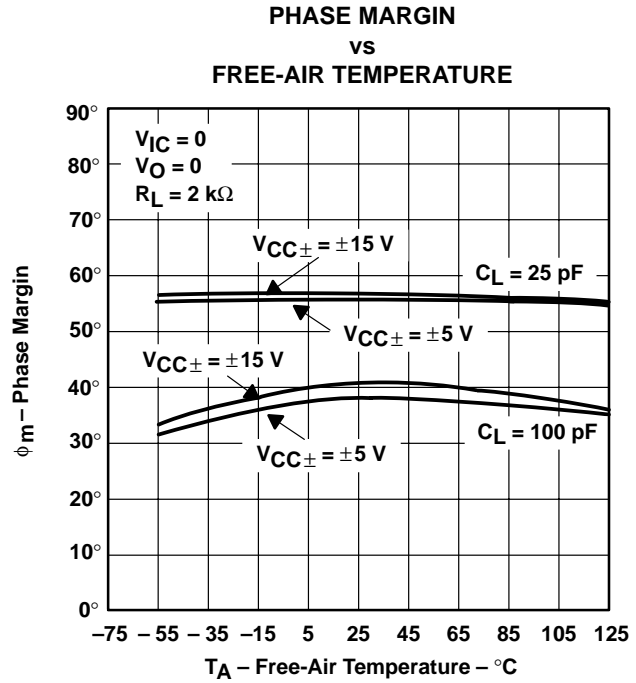

Figure 67

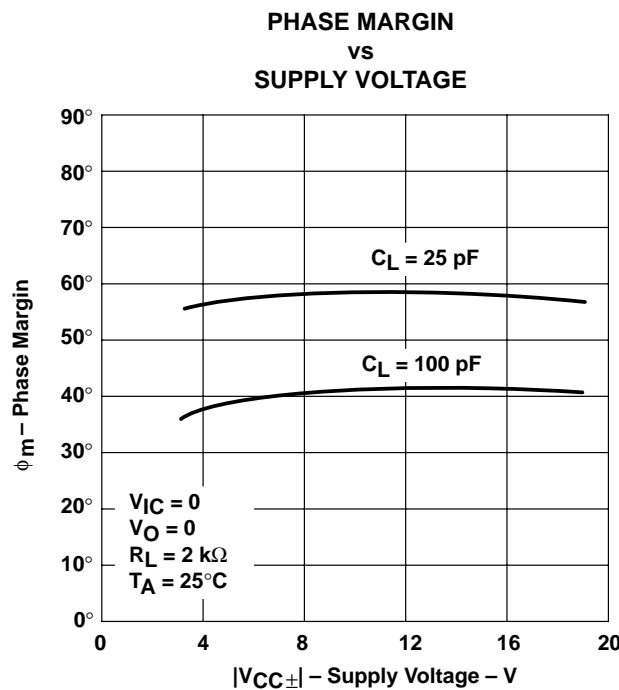

Figure 68

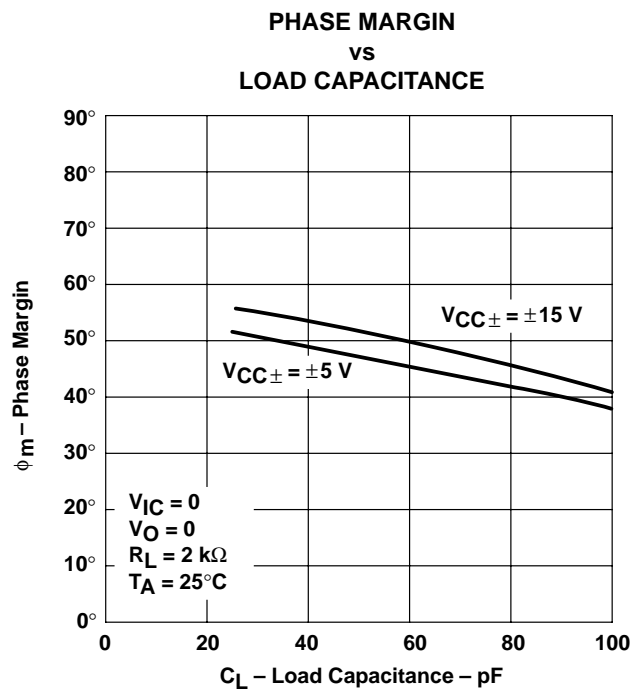

Figure 69

† Data at high and low temperatures are applicable only within the rated operating free-air temperature ranges of the various devices.

TYPICAL CHARACTERISTICS†

NONINVERTING LARGE-SIGNAL  
PULSE RESPONSE

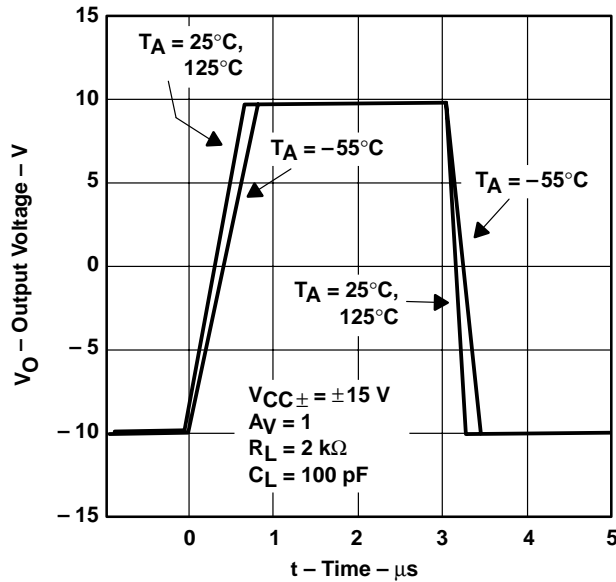

Figure 70

SMALL-SIGNAL PULSE RESPONSE



Figure 71

CLOSED-LOOP OUTPUT IMPEDANCE  
vs  
FREQUENCY

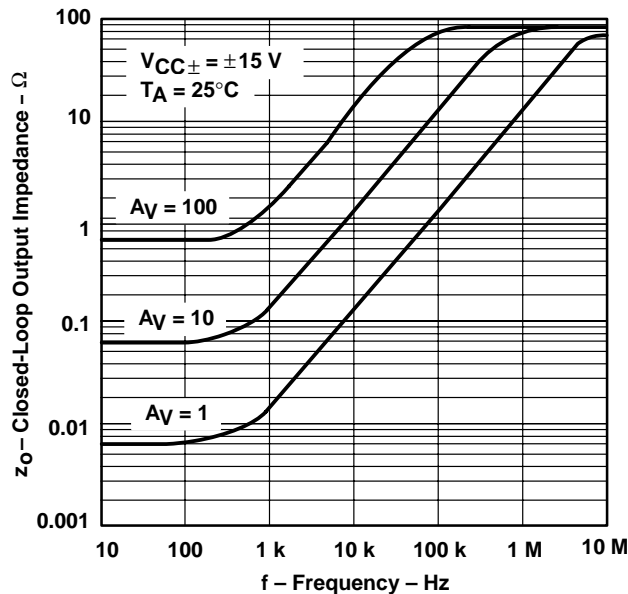

Figure 72

TLE2082 AND TLE2084  
CROSSTALK ATTENUATION  
vs  
FREQUENCY



Figure 73

† Data at high and low temperatures are applicable only within the rated operating free-air temperature ranges of the various devices.

# TLE208x, TLE208xA, TLE208xY EXCALIBUR HIGH-SPEED JFET-INPUT OPERATIONAL AMPLIFIERS

SLOS182B – FEBRUARY 1997 – REVISED JUNE 2001

## APPLICATION INFORMATION

### input characteristics

The TLE208x, TLE208xA, and TLE208xB are specified with a minimum and a maximum input voltage that if exceeded at either input could cause the device to malfunction. Because of the extremely high input impedance and resulting low bias current requirements, the TLE208x, TLE208xA, and TLE208xB are well suited for low-level signal processing; however, leakage currents on printed-circuit boards and sockets can easily exceed bias current requirements and cause degradation in system performance. It is good practice to include guard rings around inputs (see Figure 74). These guards should be driven from a low-impedance source at the same voltage level as the common-mode input.

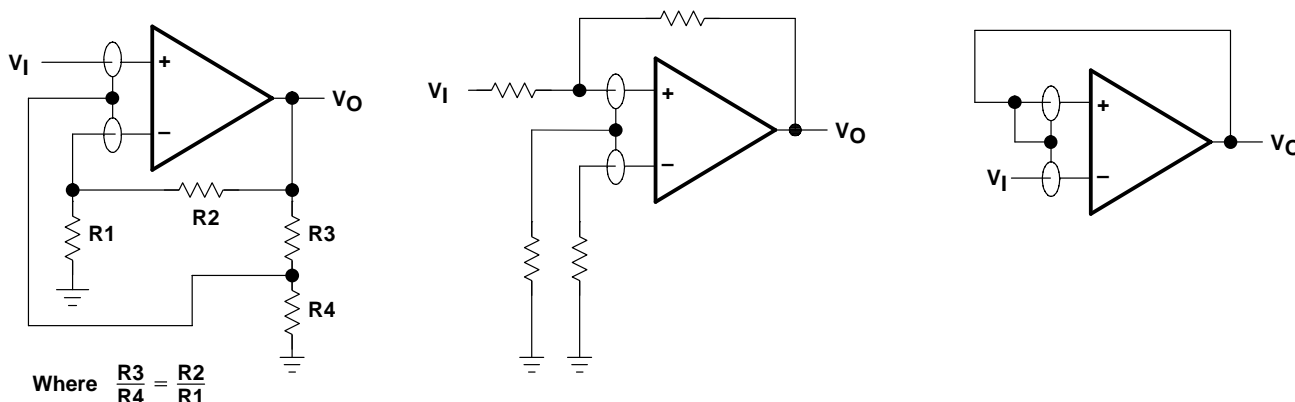

Figure 74. Use of Guard Rings

### TLE2081 input offset voltage nulling

The TLE2061 series offers external null pins that can be used to further reduce the input offset voltage. The circuit of Figure 75 can be connected as shown if the feature is desired. When external nulling is not needed, the null pins may be left unconnected.

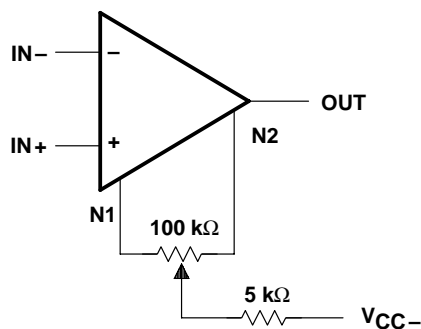

Figure 75. Input Offset Voltage Nulling



APPLICATION INFORMATION

macromodel information

Macromodel information provided was derived using PSpice™ Parts™ model generation software. The Boyle macromodel (see Note 4) and subcircuit in Figure 58 were generated using the TLE208x typical electrical and operating characteristics at T<sub>A</sub> = 25°C. Using this information, output simulations of the following key parameters can be generated to a tolerance of 20% (in most cases):

- Maximum positive output voltage swing
- Maximum negative output voltage swing
- Slew rate
- Quiescent power dissipation
- Input bias current
- Open-loop voltage amplification
- Unity-gain frequency
- Common-mode rejection ratio
- Phase margin
- DC output resistance
- AC output resistance
- Short-circuit output current limit

NOTE 4: G.R. Boyle, B.M. Cohn, D. O. Pederson, and J. E. Solomon, "Macromodeling of Integrated Circuit Operational Amplifiers", *IEEE Journal of Solid-State Circuits*, SC-9, 353 (1974).

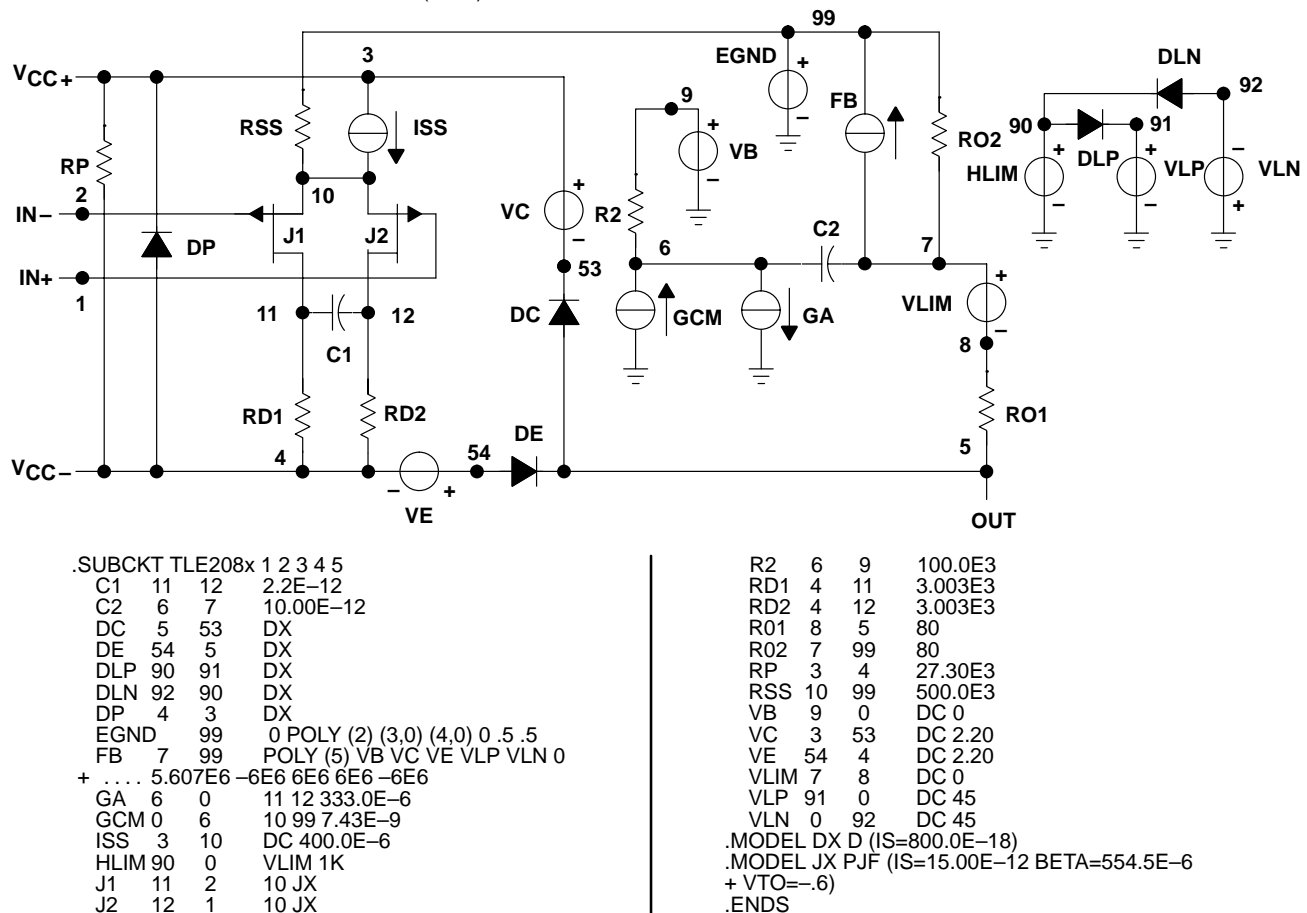

Figure 76. Boyle Macromodel and Subcircuit

PSpice and Parts are trademarks of MicroSim Corporation.

**PACKAGING INFORMATION**

Orderable Device	Status (1)	Package Type	Package Drawing	Pins	Package Qty	Eco Plan (2)	Lead/Ball Finish (6)	MSL Peak Temp (3)	Op Temp (°C)	Device Marking (4/5)	Samples
TLE2081ACD	ACTIVE	SOIC	D	8	75	Green (RoHS & no Sb/Br)	CU NIPDAU	Level-1-260C-UNLIM	0 to 70	2081AC	<a href="#">Samples</a>
TLE2081ACDG4	ACTIVE	SOIC	D	8	75	Green (RoHS & no Sb/Br)	CU NIPDAU	Level-1-260C-UNLIM	0 to 70	2081AC	<a href="#">Samples</a>
TLE2081ACDR	ACTIVE	SOIC	D	8	2500	Green (RoHS & no Sb/Br)	CU NIPDAU	Level-1-260C-UNLIM	0 to 70	2081AC	<a href="#">Samples</a>
TLE2081ACDRG4	ACTIVE	SOIC	D	8	2500	Green (RoHS & no Sb/Br)	CU NIPDAU	Level-1-260C-UNLIM	0 to 70	2081AC	<a href="#">Samples</a>
TLE2081ACP	ACTIVE	PDIP	P	8	50	Pb-Free (RoHS)	CU NIPDAU	N / A for Pkg Type	-40 to 85	TLE2081AC	<a href="#">Samples</a>
TLE2081AID	ACTIVE	SOIC	D	8	75	Green (RoHS & no Sb/Br)	CU NIPDAU	Level-1-260C-UNLIM	-40 to 85	2081AI	<a href="#">Samples</a>
TLE2081AIP	ACTIVE	PDIP	P	8	50	Pb-Free (RoHS)	CU NIPDAU	N / A for Pkg Type	-40 to 85	TLE2081AI	<a href="#">Samples</a>
TLE2081CD	ACTIVE	SOIC	D	8	75	Green (RoHS & no Sb/Br)	CU NIPDAU	Level-1-260C-UNLIM	0 to 70	2081C	<a href="#">Samples</a>
TLE2081CDG4	ACTIVE	SOIC	D	8	75	Green (RoHS & no Sb/Br)	CU NIPDAU	Level-1-260C-UNLIM	0 to 70	2081C	<a href="#">Samples</a>
TLE2081CDR	ACTIVE	SOIC	D	8	2500	Green (RoHS & no Sb/Br)	CU NIPDAU	Level-1-260C-UNLIM	0 to 70	2081C	<a href="#">Samples</a>
TLE2081CP	ACTIVE	PDIP	P	8	50	Pb-Free (RoHS)	CU NIPDAU	N / A for Pkg Type	0 to 70	TLE2081CP	<a href="#">Samples</a>
TLE2081CPE4	ACTIVE	PDIP	P	8	50	Pb-Free (RoHS)	CU NIPDAU	N / A for Pkg Type	0 to 70	TLE2081CP	<a href="#">Samples</a>
TLE2081ID	ACTIVE	SOIC	D	8	75	Green (RoHS & no Sb/Br)	CU NIPDAU	Level-1-260C-UNLIM	-40 to 85	2081I	<a href="#">Samples</a>
TLE2081IDG4	ACTIVE	SOIC	D	8	75	Green (RoHS & no Sb/Br)	CU NIPDAU	Level-1-260C-UNLIM	-40 to 85	2081I	<a href="#">Samples</a>
TLE2081IDR	ACTIVE	SOIC	D	8	2500	Green (RoHS & no Sb/Br)	CU NIPDAU	Level-1-260C-UNLIM		2081I	<a href="#">Samples</a>
TLE2081IP	ACTIVE	PDIP	P	8	50	Pb-Free (RoHS)	CU NIPDAU	N / A for Pkg Type		TLE2081IP	<a href="#">Samples</a>
TLE2082ACD	ACTIVE	SOIC	D	8	75	Green (RoHS & no Sb/Br)	CU NIPDAU	Level-1-260C-UNLIM	0 to 70	2082AC	<a href="#">Samples</a>

Orderable Device	Status (1)	Package Type	Package Drawing	Pins	Package Qty	Eco Plan (2)	Lead/Ball Finish (6)	MSL Peak Temp (3)	Op Temp (°C)	Device Marking (4/5)	Samples
TLE2082ACDG4	ACTIVE	SOIC	D	8	75	Green (RoHS & no Sb/Br)	CU NIPDAU	Level-1-260C-UNLIM	0 to 70	2082AC	<a href="#">Samples</a>
TLE2082ACDR	ACTIVE	SOIC	D	8	2500	Green (RoHS & no Sb/Br)	CU NIPDAU	Level-1-260C-UNLIM		2082AC	<a href="#">Samples</a>
TLE2082ACDRG4	ACTIVE	SOIC	D	8	2500	Green (RoHS & no Sb/Br)	CU NIPDAU	Level-1-260C-UNLIM		2082AC	<a href="#">Samples</a>
TLE2082ACP	ACTIVE	PDIP	P	8	50	Pb-Free (RoHS)	CU NIPDAU	N / A for Pkg Type		TLE2082AC	<a href="#">Samples</a>
TLE2082ACPE4	ACTIVE	PDIP	P	8	50	Pb-Free (RoHS)	CU NIPDAU	N / A for Pkg Type		TLE2082AC	<a href="#">Samples</a>
TLE2082AID	ACTIVE	SOIC	D	8	75	Green (RoHS & no Sb/Br)	CU NIPDAU	Level-1-260C-UNLIM	-40 to 85	2082AI	<a href="#">Samples</a>
TLE2082AIDG4	ACTIVE	SOIC	D	8	75	Green (RoHS & no Sb/Br)	CU NIPDAU	Level-1-260C-UNLIM	-40 to 85	2082AI	<a href="#">Samples</a>
TLE2082AIDR	ACTIVE	SOIC	D	8	2500	Green (RoHS & no Sb/Br)	CU NIPDAU	Level-1-260C-UNLIM		2082AI	<a href="#">Samples</a>
TLE2082AIDRG4	ACTIVE	SOIC	D	8	2500	Green (RoHS & no Sb/Br)	CU NIPDAU	Level-1-260C-UNLIM		2082AI	<a href="#">Samples</a>
TLE2082AIP	ACTIVE	PDIP	P	8	50	Pb-Free (RoHS)	CU NIPDAU	N / A for Pkg Type		TLE2082AI	<a href="#">Samples</a>
TLE2082AIPE4	ACTIVE	PDIP	P	8	50	Pb-Free (RoHS)	CU NIPDAU	N / A for Pkg Type		TLE2082AI	<a href="#">Samples</a>
TLE2082CD	ACTIVE	SOIC	D	8	75	Green (RoHS & no Sb/Br)	CU NIPDAU	Level-1-260C-UNLIM	0 to 70	2082C	<a href="#">Samples</a>
TLE2082CDG4	ACTIVE	SOIC	D	8	75	Green (RoHS & no Sb/Br)	CU NIPDAU	Level-1-260C-UNLIM	0 to 70	2082C	<a href="#">Samples</a>
TLE2082CDR	ACTIVE	SOIC	D	8	2500	Green (RoHS & no Sb/Br)	CU NIPDAU	Level-1-260C-UNLIM		2082C	<a href="#">Samples</a>
TLE2082CDRG4	ACTIVE	SOIC	D	8	2500	Green (RoHS & no Sb/Br)	CU NIPDAU	Level-1-260C-UNLIM		2082C	<a href="#">Samples</a>
TLE2082CP	ACTIVE	PDIP	P	8	50	Pb-Free (RoHS)	CU NIPDAU	N / A for Pkg Type		TLE2082CP	<a href="#">Samples</a>
TLE2082CPE4	ACTIVE	PDIP	P	8	50	Pb-Free (RoHS)	CU NIPDAU	N / A for Pkg Type		TLE2082CP	<a href="#">Samples</a>
TLE2082ID	ACTIVE	SOIC	D	8	75	Green (RoHS & no Sb/Br)	CU NIPDAU	Level-1-260C-UNLIM	-40 to 85	2082I	<a href="#">Samples</a>

Orderable Device	Status (1)	Package Type	Package Drawing	Pins	Package Qty	Eco Plan (2)	Lead/Ball Finish (6)	MSL Peak Temp (3)	Op Temp (°C)	Device Marking (4/5)	Samples
TLE2082IDG4	ACTIVE	SOIC	D	8	75	Green (RoHS & no Sb/Br)	CU NIPDAU	Level-1-260C-UNLIM	-40 to 85	2082I	<a href="#">Samples</a>
TLE2082IDR	ACTIVE	SOIC	D	8	2500	Green (RoHS & no Sb/Br)	CU NIPDAU	Level-1-260C-UNLIM		2082I	<a href="#">Samples</a>
TLE2082IDRG4	ACTIVE	SOIC	D	8	2500	Green (RoHS & no Sb/Br)	CU NIPDAU	Level-1-260C-UNLIM		2082I	<a href="#">Samples</a>
TLE2082IP	ACTIVE	PDIP	P	8	50	Pb-Free (RoHS)	CU NIPDAU	N / A for Pkg Type		TLE2082IP	<a href="#">Samples</a>
TLE2082IPE4	ACTIVE	PDIP	P	8	50	Pb-Free (RoHS)	CU NIPDAU	N / A for Pkg Type		TLE2082IP	<a href="#">Samples</a>
TLE2084ACDW	ACTIVE	SOIC	DW	16	40	Green (RoHS & no Sb/Br)	CU NIPDAU	Level-1-260C-UNLIM	0 to 70	TLE2084AC	<a href="#">Samples</a>
TLE2084ACDWG4	ACTIVE	SOIC	DW	16	40	Green (RoHS & no Sb/Br)	CU NIPDAU	Level-1-260C-UNLIM	0 to 70	TLE2084AC	<a href="#">Samples</a>
TLE2084ACN	ACTIVE	PDIP	N	14	25	Pb-Free (RoHS)	CU NIPDAU	N / A for Pkg Type	0 to 70	TLE2084ACN	<a href="#">Samples</a>
TLE2084CDW	ACTIVE	SOIC	DW	16	40	Green (RoHS & no Sb/Br)	CU NIPDAU	Level-1-260C-UNLIM	0 to 70	TLE2084C	<a href="#">Samples</a>
TLE2084CDWG4	ACTIVE	SOIC	DW	16	40	Green (RoHS & no Sb/Br)	CU NIPDAU	Level-1-260C-UNLIM	0 to 70	TLE2084C	<a href="#">Samples</a>
TLE2084CDWR	ACTIVE	SOIC	DW	16	2000	Green (RoHS & no Sb/Br)	CU NIPDAU	Level-1-260C-UNLIM		TLE2084C	<a href="#">Samples</a>
TLE2084CN	ACTIVE	PDIP	N	14	25	Pb-Free (RoHS)	CU NIPDAU	N / A for Pkg Type		TLE2084CN	<a href="#">Samples</a>
TLE2084CNE4	ACTIVE	PDIP	N	14	25	Pb-Free (RoHS)	CU NIPDAU	N / A for Pkg Type		TLE2084CN	<a href="#">Samples</a>
TLE2084IDW	ACTIVE	SOIC	DW	16	40	Green (RoHS & no Sb/Br)	CU NIPDAU	Level-1-260C-UNLIM	-40 to 85	TLE2084I	<a href="#">Samples</a>
TLE2084IDWG4	ACTIVE	SOIC	DW	16	40	Green (RoHS & no Sb/Br)	CU NIPDAU	Level-1-260C-UNLIM	-40 to 85	TLE2084I	<a href="#">Samples</a>

(1) The marketing status values are defined as follows:

**ACTIVE:** Product device recommended for new designs.

**LIFEBUY:** TI has announced that the device will be discontinued, and a lifetime-buy period is in effect.

**NRND:** Not recommended for new designs. Device is in production to support existing customers, but TI does not recommend using this part in a new design.

**PREVIEW:** Device has been announced but is not in production. Samples may or may not be available.

**OBSOLETE:** TI has discontinued the production of the device.

<sup>(2)</sup> Eco Plan - The planned eco-friendly classification: Pb-Free (RoHS), Pb-Free (RoHS Exempt), or Green (RoHS & no Sb/Br) - please check <http://www.ti.com/productcontent> for the latest availability information and additional product content details.

**TBD:** The Pb-Free/Green conversion plan has not been defined.

**Pb-Free (RoHS):** TI's terms "Lead-Free" or "Pb-Free" mean semiconductor products that are compatible with the current RoHS requirements for all 6 substances, including the requirement that lead not exceed 0.1% by weight in homogeneous materials. Where designed to be soldered at high temperatures, TI Pb-Free products are suitable for use in specified lead-free processes.

**Pb-Free (RoHS Exempt):** This component has a RoHS exemption for either 1) lead-based flip-chip solder bumps used between the die and package, or 2) lead-based die adhesive used between the die and leadframe. The component is otherwise considered Pb-Free (RoHS compatible) as defined above.

**Green (RoHS & no Sb/Br):** TI defines "Green" to mean Pb-Free (RoHS compatible), and free of Bromine (Br) and Antimony (Sb) based flame retardants (Br or Sb do not exceed 0.1% by weight in homogeneous material)

<sup>(3)</sup> MSL, Peak Temp. - The Moisture Sensitivity Level rating according to the JEDEC industry standard classifications, and peak solder temperature.

<sup>(4)</sup> There may be additional marking, which relates to the logo, the lot trace code information, or the environmental category on the device.

<sup>(5)</sup> Multiple Device Markings will be inside parentheses. Only one Device Marking contained in parentheses and separated by a "~" will appear on a device. If a line is indented then it is a continuation of the previous line and the two combined represent the entire Device Marking for that device.

<sup>(6)</sup> Lead/Ball Finish - Orderable Devices may have multiple material finish options. Finish options are separated by a vertical ruled line. Lead/Ball Finish values may wrap to two lines if the finish value exceeds the maximum column width.

**Important Information and Disclaimer:** The information provided on this page represents TI's knowledge and belief as of the date that it is provided. TI bases its knowledge and belief on information provided by third parties, and makes no representation or warranty as to the accuracy of such information. Efforts are underway to better integrate information from third parties. TI has taken and continues to take reasonable steps to provide representative and accurate information but may not have conducted destructive testing or chemical analysis on incoming materials and chemicals. TI and TI suppliers consider certain information to be proprietary, and thus CAS numbers and other limited information may not be available for release.

In no event shall TI's liability arising out of such information exceed the total purchase price of the TI part(s) at issue in this document sold by TI to Customer on an annual basis.

**TAPE AND REEL INFORMATION**

**QUADRANT ASSIGNMENTS FOR PIN 1 ORIENTATION IN TAPE**

\*All dimensions are nominal

Device	Package Type	Package Drawing	Pins	SPQ	Reel Diameter (mm)	Reel Width W1 (mm)	A0 (mm)	B0 (mm)	K0 (mm)	P1 (mm)	W (mm)	Pin1 Quadrant
TLE2081ACDR	SOIC	D	8	2500	330.0	12.4	6.4	5.2	2.1	8.0	12.0	Q1
TLE2081CDR	SOIC	D	8	2500	330.0	12.4	6.4	5.2	2.1	8.0	12.0	Q1
TLE2081IDR	SOIC	D	8	2500	330.0	12.4	6.4	5.2	2.1	8.0	12.0	Q1
TLE2081IDR	SOIC	D	8	2500	330.0	12.4	6.4	5.2	2.1	8.0	12.0	Q1
TLE2082ACDR	SOIC	D	8	2500	330.0	12.4	6.4	5.2	2.1	8.0	12.0	Q1
TLE2082AIDR	SOIC	D	8	2500	330.0	12.4	6.4	5.2	2.1	8.0	12.0	Q1
TLE2082AIDR	SOIC	D	8	2500	330.0	12.4	6.4	5.2	2.1	8.0	12.0	Q1
TLE2082CDR	SOIC	D	8	2500	330.0	12.4	6.4	5.2	2.1	8.0	12.0	Q1
TLE2082IDR	SOIC	D	8	2500	330.0	12.4	6.4	5.2	2.1	8.0	12.0	Q1
TLE2084CDWR	SOIC	DW	16	2000	330.0	16.4	10.75	10.7	2.7	12.0	16.0	Q1

**TAPE AND REEL BOX DIMENSIONS**

\*All dimensions are nominal

Device	Package Type	Package Drawing	Pins	SPQ	Length (mm)	Width (mm)	Height (mm)
TLE2081ACDR	SOIC	D	8	2500	340.5	338.1	20.6
TLE2081CDR	SOIC	D	8	2500	340.5	338.1	20.6
TLE2081IDR	SOIC	D	8	2500	340.5	338.1	20.6
TLE2081IDR	SOIC	D	8	2500	367.0	367.0	38.0
TLE2082ACDR	SOIC	D	8	2500	340.5	338.1	20.6
TLE2082AIDR	SOIC	D	8	2500	367.0	367.0	38.0
TLE2082AIDR	SOIC	D	8	2500	340.5	338.1	20.6
TLE2082CDR	SOIC	D	8	2500	340.5	338.1	20.6
TLE2082IDR	SOIC	D	8	2500	340.5	338.1	20.6
TLE2084CDWR	SOIC	DW	16	2000	367.0	367.0	38.0

DW (R-PDSO-G16)

PLASTIC SMALL OUTLINE



- NOTES:
- All linear dimensions are in inches (millimeters). Dimensioning and tolerancing per ASME Y14.5M-1994.
  - This drawing is subject to change without notice.
  - Body dimensions do not include mold flash or protrusion not to exceed 0.006 (0,15).
  - Falls within JEDEC MS-013 variation AA.



D (R-PDSO-G8)

PLASTIC SMALL OUTLINE



NOTES: A. All linear dimensions are in inches (millimeters).  
 B. This drawing is subject to change without notice.  
 C. Body length does not include mold flash, protrusions, or gate burrs. Mold flash, protrusions, or gate burrs shall not exceed 0.006 (0,15) each side.  
 D. Body width does not include interlead flash. Interlead flash shall not exceed 0.017 (0,43) each side.  
 E. Reference JEDEC MS-012 variation AA.

D (R-PDSO-G8)

PLASTIC SMALL OUTLINE



- NOTES:
- All linear dimensions are in millimeters.
  - This drawing is subject to change without notice.
  - Publication IPC-7351 is recommended for alternate designs.
  - Laser cutting apertures with trapezoidal walls and also rounding corners will offer better paste release. Customers should contact their board assembly site for stencil design recommendations. Refer to IPC-7525 for other stencil recommendations.
  - Customers should contact their board fabrication site for solder mask tolerances between and around signal pads.

P (R-PDIP-T8)

PLASTIC DUAL-IN-LINE PACKAGE



- NOTES:
- A. All linear dimensions are in inches (millimeters).
  - B. This drawing is subject to change without notice.
  - C. Falls within JEDEC MS-001 variation BA.

N (R-PDIP-T\*\*)

PLASTIC DUAL-IN-LINE PACKAGE

16 PINS SHOWN



- NOTES:
- A. All linear dimensions are in inches (millimeters).
  - B. This drawing is subject to change without notice.
  - $\triangle C$  Falls within JEDEC MS-001, except 18 and 20 pin minimum body length (Dim A).
  - $\triangle D$  The 20 pin end lead shoulder width is a vendor option, either half or full width.

4040049/E 12/2002

## IMPORTANT NOTICE FOR TI DESIGN INFORMATION AND RESOURCES

Texas Instruments Incorporated ("TI") technical, application or other design advice, services or information, including, but not limited to, reference designs and materials relating to evaluation modules, (collectively, "TI Resources") are intended to assist designers who are developing applications that incorporate TI products; by downloading, accessing or using any particular TI Resource in any way, you (individually or, if you are acting on behalf of a company, your company) agree to use it solely for this purpose and subject to the terms of this Notice.

TI's provision of TI Resources does not expand or otherwise alter TI's applicable published warranties or warranty disclaimers for TI products, and no additional obligations or liabilities arise from TI providing such TI Resources. TI reserves the right to make corrections, enhancements, improvements and other changes to its TI Resources.

You understand and agree that you remain responsible for using your independent analysis, evaluation and judgment in designing your applications and that you have full and exclusive responsibility to assure the safety of your applications and compliance of your applications (and of all TI products used in or for your applications) with all applicable regulations, laws and other applicable requirements. You represent that, with respect to your applications, you have all the necessary expertise to create and implement safeguards that (1) anticipate dangerous consequences of failures, (2) monitor failures and their consequences, and (3) lessen the likelihood of failures that might cause harm and take appropriate actions. You agree that prior to using or distributing any applications that include TI products, you will thoroughly test such applications and the functionality of such TI products as used in such applications. TI has not conducted any testing other than that specifically described in the published documentation for a particular TI Resource.

You are authorized to use, copy and modify any individual TI Resource only in connection with the development of applications that include the TI product(s) identified in such TI Resource. NO OTHER LICENSE, EXPRESS OR IMPLIED, BY ESTOPPEL OR OTHERWISE TO ANY OTHER TI INTELLECTUAL PROPERTY RIGHT, AND NO LICENSE TO ANY TECHNOLOGY OR INTELLECTUAL PROPERTY RIGHT OF TI OR ANY THIRD PARTY IS GRANTED HEREIN, including but not limited to any patent right, copyright, mask work right, or other intellectual property right relating to any combination, machine, or process in which TI products or services are used. Information regarding or referencing third-party products or services does not constitute a license to use such products or services, or a warranty or endorsement thereof. Use of TI Resources may require a license from a third party under the patents or other intellectual property of the third party, or a license from TI under the patents or other intellectual property of TI.

TI RESOURCES ARE PROVIDED "AS IS" AND WITH ALL FAULTS. TI DISCLAIMS ALL OTHER WARRANTIES OR REPRESENTATIONS, EXPRESS OR IMPLIED, REGARDING TI RESOURCES OR USE THEREOF, INCLUDING BUT NOT LIMITED TO ACCURACY OR COMPLETENESS, TITLE, ANY EPIDEMIC FAILURE WARRANTY AND ANY IMPLIED WARRANTIES OF MERCHANTABILITY, FITNESS FOR A PARTICULAR PURPOSE, AND NON-INFRINGEMENT OF ANY THIRD PARTY INTELLECTUAL PROPERTY RIGHTS.

TI SHALL NOT BE LIABLE FOR AND SHALL NOT DEFEND OR INDEMNIFY YOU AGAINST ANY CLAIM, INCLUDING BUT NOT LIMITED TO ANY INFRINGEMENT CLAIM THAT RELATES TO OR IS BASED ON ANY COMBINATION OF PRODUCTS EVEN IF DESCRIBED IN TI RESOURCES OR OTHERWISE. IN NO EVENT SHALL TI BE LIABLE FOR ANY ACTUAL, DIRECT, SPECIAL, COLLATERAL, INDIRECT, PUNITIVE, INCIDENTAL, CONSEQUENTIAL OR EXEMPLARY DAMAGES IN CONNECTION WITH OR ARISING OUT OF TI RESOURCES OR USE THEREOF, AND REGARDLESS OF WHETHER TI HAS BEEN ADVISED OF THE POSSIBILITY OF SUCH DAMAGES.

You agree to fully indemnify TI and its representatives against any damages, costs, losses, and/or liabilities arising out of your non-compliance with the terms and provisions of this Notice.

This Notice applies to TI Resources. Additional terms apply to the use and purchase of certain types of materials, TI products and services. These include; without limitation, TI's standard terms for semiconductor products (<http://www.ti.com/sc/docs/stdterms.htm>), [evaluation modules](#), and [samples](http://www.ti.com/sc/docs/sampterm.htm) (<http://www.ti.com/sc/docs/sampterm.htm>).

Mailing Address: Texas Instruments, Post Office Box 655303, Dallas, Texas 75265  
Copyright © 2017, Texas Instruments Incorporated