

TLV62568 1-A High Efficiency Synchronous Buck Converter in SOT Package

1 Features

- Up to 95% Efficiency
- Low $R_{DS(ON)}$ Switches 150 m Ω / 100 m Ω
- 2.5-V to 5.5-V Input Voltage Range
- Adjustable Output Voltage from 0.6 V to V_{IN}
- Power Save Mode for Light Load Efficiency
- 100% Duty Cycle for Lowest Dropout
- 35- μ A Operating Quiescent Current
- 1.5-MHz Switching Frequency
- Power Good Output
- Over Current Protection
- Internal Soft Startup
- Thermal Shutdown Protection
- Available in SOT Package
- Pin-to-Pin Compatible with [TLV62569](#)

2 Applications

- General Purpose POL Supply
- Network Video Camera
- Set Top Box
- Wireless Router

3 Description

The TLV62568 device is a synchronous step-down buck DC-DC converter optimized for high efficiency and compact solution size. The device integrates switches capable of delivering an output current up to 1 A.

At medium to heavy loads, the device operates in pulse width modulation (PWM) mode with 1.5-MHz switching frequency. At light load, the device automatically enters Power Save Mode (PSM) to maintain high efficiency over the entire load current range. In shutdown, the current consumption is reduced to less than 2 μ A.

The TLV62568 provides an adjustable output voltage via an external resistor divider. An internal soft start circuit limits the inrush current during startup. Other features like over current protection, thermal shutdown protection and power good are built-in. The device is available in a SOT23 and SOT563 package.

Device Information⁽¹⁾

PART NUMBER	PACKAGE	BODY SIZE (NOM)
TLV62568	SOT-23 (5)	2.90 mm x 2.80 mm
TLV62568P	SOT-23 (6)	
TLV62568	SOT563 (6)	1.60 mm x 1.60 mm
TLV62568P	SOT563 (6)	

(1) For all available packages, see [Mechanical, Packaging, and Orderable Information](#) at the end of the datasheet.

Simplified Schematic

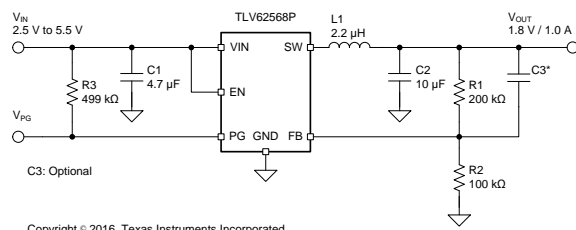

Efficiency at 5-V Input Voltage

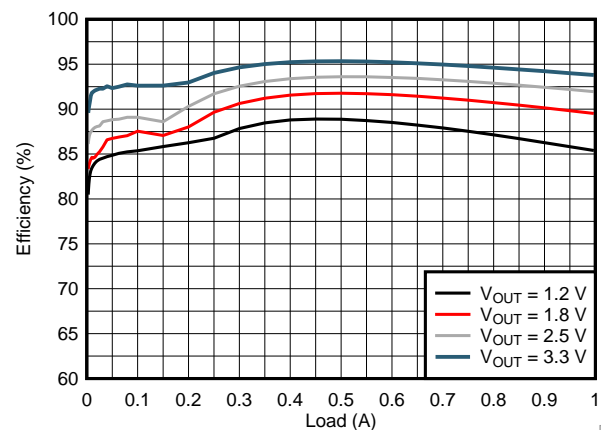

D008



Table of Contents

1	Features	1	9	Application and Implementation	9
2	Applications	1	9.1	Application Information.....	9
3	Description	1	9.2	Typical Application	9
4	Revision History	2	10	Power Supply Recommendations	13
5	Device Options	3	11	Layout	13
6	Pin Configuration and Functions	3	11.1	Layout Guidelines	13
7	Specifications	4	11.2	Layout Example	14
7.1	Absolute Maximum Ratings	4	11.3	Thermal Considerations	14
7.2	ESD Ratings.....	4	12	Device and Documentation Support	15
7.3	Recommended Operating Conditions	4	12.1	Device Support	15
7.4	Thermal Information	4	12.2	Documentation Support	15
7.5	Electrical Characteristics.....	5	12.3	Receiving Notification of Documentation Updates	15
7.6	Typical Characteristics	6	12.4	Community Resources.....	15
8	Detailed Description	7	12.5	Trademarks	15
8.1	Overview	7	12.6	Electrostatic Discharge Caution.....	15
8.2	Functional Block Diagram	7	12.7	Glossary	15
8.3	Feature Description.....	7	13	Mechanical, Packaging, and Orderable Information	16
8.4	Device Functional Modes.....	8			

4 Revision History

DATE	REVISION	NOTES
November 2016	*	Initial release.

5 Device Options

PART NUMBER ⁽¹⁾	FUNCTION	PACKAGE MARKING	PACKAGE
TLV62568DBV	-	14VF	SOT23-5
TLV62568PDDC ⁽²⁾	Power Good		SOT23-6
TLV62568DRL ⁽²⁾	-		SOT563-6
TLV62568PDRL ⁽²⁾	Power Good		SOT563-6

- (1) For detailed ordering information, please check [Mechanical, Packaging, and Orderable Information](#) at the end of this datasheet.
 (2) Product preview

6 Pin Configuration and Functions

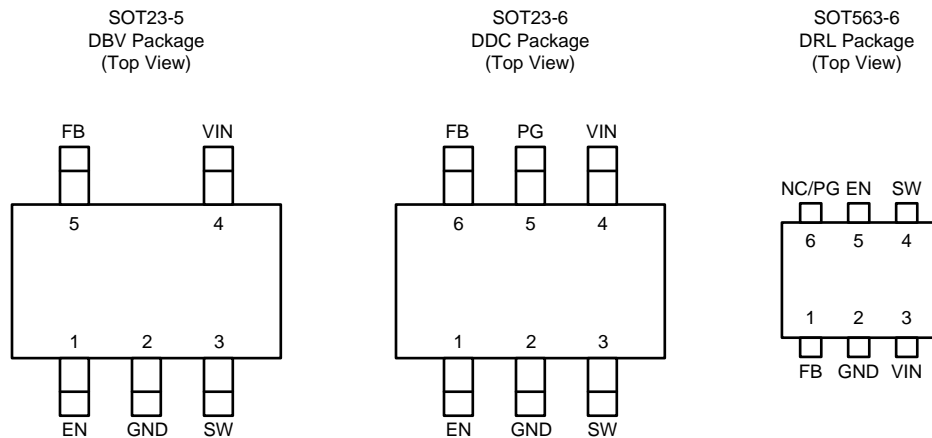

Pin Functions

NAME	PIN NUMBER			I/O/PWR	DESCRIPTION
	SOT23-5	SOT23-6	SOT563-6		
EN	1	1	5	I	Device enable logic input. Logic high enables the device, logic low disables the device and turns it into shutdown. Do not leave floating.
GND	2	2	2	PWR	Ground pin.
SW	3	3	4	PWR	Switch pin connected to the internal FET switches and inductor terminal. Connect the inductor of the output filter to this pin.
VIN	4	4	3	PWR	Power supply voltage input.
PG	-	5	6	O	Power good open drain output pin for TLV62568P. The pull-up resistor should not be connected to any voltage higher than 5.5V. If it's not used, leave the pin floating.
FB	5	6	1	I	Feedback pin for the internal control loop. Connect this pin to an external feedback divider.
NC	-	-	6	O	No connection pin for TLV62568DRL. The pin can be connected to the output. Or leave it floating.

7 Specifications

7.1 Absolute Maximum Ratings

Over operating temperature range (unless otherwise noted)⁽¹⁾

		MIN	MAX	UNIT
Voltage ⁽²⁾	VIN, EN, PG	-0.3	6	V
	SW (DC)	-0.3	VIN+0.3	V
	SW (AC, less than 10 ns) ⁽³⁾	-3.0	9	V
	FB	-0.3	5.5	V
Operating junction temperature, T _J		-40	150	°C
Storage temperature, T _{stg}		-65	150	°C

- (1) Stresses beyond those listed under *absolute maximum ratings* may cause permanent damage to the device. These are stress ratings only and the device is not switching. Functional operation of the device at these or any other conditions beyond those indicated under *recommended operating conditions* is not implied. Exposure to absolute–maximum–rated conditions for extended periods may affect device reliability.
- (2) All voltage values are with respect to network ground terminal.
- (3) Normal switching operation

7.2 ESD Ratings

			VALUE	UNIT
V _(ESD)	Electrostatic discharge	Human-body model (HBM), per ANSI/ESDA/JEDEC JS-001 ⁽¹⁾	±2000	V
		Charged-device model (CDM), per JEDEC specification JESD22-C101 ⁽²⁾	±500	V

- (1) JEDEC document JEP155 states that 500-V HBM allows safe manufacturing with a standard ESD control process.
- (2) JEDEC document JEP157 states that 250-V CDM allows safe manufacturing with a standard ESD control process.

7.3 Recommended Operating Conditions⁽¹⁾

		MIN	TYP	MAX	UNIT
V _{IN}	Input voltage	2.5		5.5	V
V _{OUT}	Output voltage	0.6		V _{IN}	V
I _{OUT}	Output current			1	A
T _J	Operating junction temperature	-40		125	°C
I _{SINK_PG}	Sink current at PG pin			1	mA

- (1) Refer to the [Application and Implementation](#) section for further information.

7.4 Thermal Information

THERMAL METRIC ⁽¹⁾		TLV62568	UNIT
		DBV (5 Pins)	
R _{θJA}	Junction-to-ambient thermal resistance	191.6	°C/W
R _{θJC(top)}	Junction-to-case (top) thermal resistance	141.4	°C/W
R _{θJB}	Junction-to-board thermal resistance	44.5	°C/W
ψ _{JT}	Junction-to-top characterization parameter	34.5	°C/W
ψ _{JB}	Junction-to-board characterization parameter	43.9	°C/W
R _{θJC(bot)}	Junction-to-case (bottom) thermal resistance	N/A	°C/W

- (1) For more information about traditional and new thermal metrics, see the *IC Package Thermal Metrics* application report, [SPRA953](#).

7.5 Electrical Characteristics

 $V_{IN} = 5.0\text{ V}$, $T_J = 25^\circ\text{C}$, unless otherwise noted

PARAMETER		TEST CONDITIONS	MIN	TYP	MAX	UNIT
SUPPLY						
I_Q	Quiescent current into VIN pin	Not switching		35		μA
I_{SD}	Shutdown current into VIN pin	EN = 0 V		0.1	2	μA
V_{UVLO}	Under voltage lock out	V_{IN} falling		2.3	2.45	V
	Under voltage lock out hysteresis			100		mV
T_{JSD}	Thermal shutdown threshold	Junction temperature rising		150		$^\circ\text{C}$
		Junction temperature falling		130		
LOGIC INTERFACE						
V_{IH}	High-level input voltage at EN pin	$2.5\text{ V} \leq V_{IN} \leq 5.5\text{ V}$	1.2	0.95		V
V_{IL}	Low-level input voltage at EN pin	$2.5\text{ V} \leq V_{IN} \leq 5.5\text{ V}$		0.85	0.4	V
t_{SS}	Soft startup time			700		μs
V_{PG}	Power good threshold, TLV62568P	V_{FB} rising, referenced to V_{FB} nominal		95%		
		V_{FB} falling, referenced to V_{FB} nominal		90%		
$V_{PG,OL}$	Power good low-level output voltage	$I_{SINK} = 1\text{ mA}$			0.4	V
$I_{PG,LKG}$	Input leakage current into PG pin	$V_{PG} = 5.0\text{ V}$		0.01		μA
$t_{PG,DLY}$	Power good delay time	V_{FB} falling		40		μs
OUTPUT						
V_{FB}	Feedback regulation voltage		0.588	0.6	0.612	V
$R_{DS(on)}$	High-side FET on resistance			150		m Ω
	Low-side FET on resistance			100		
I_{LIM}	High-side FET current limit		1.5			A
f_{SW}	Switching frequency	$V_{OUT} = 1.8\text{ V}$		1.5		MHz

7.6 Typical Characteristics

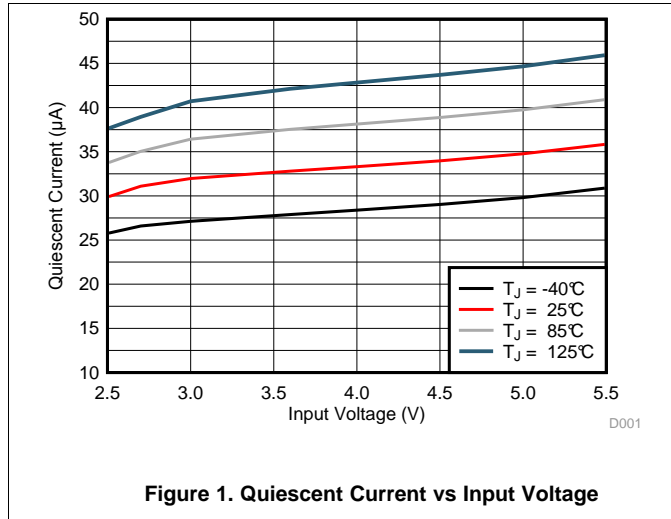

Figure 1. Quiescent Current vs Input Voltage

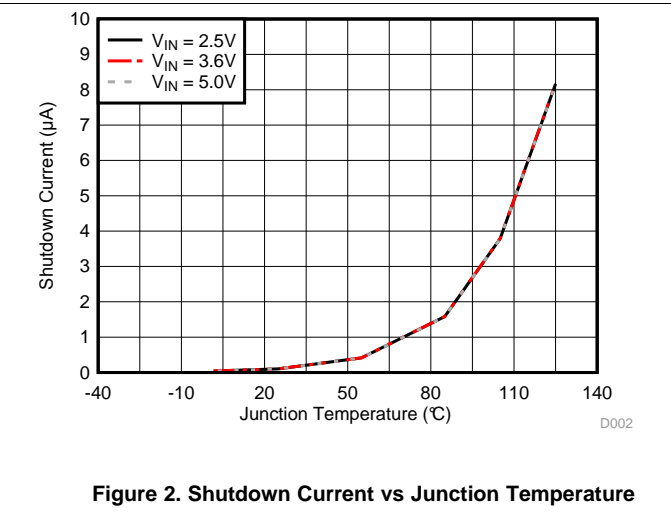

Figure 2. Shutdown Current vs Junction Temperature

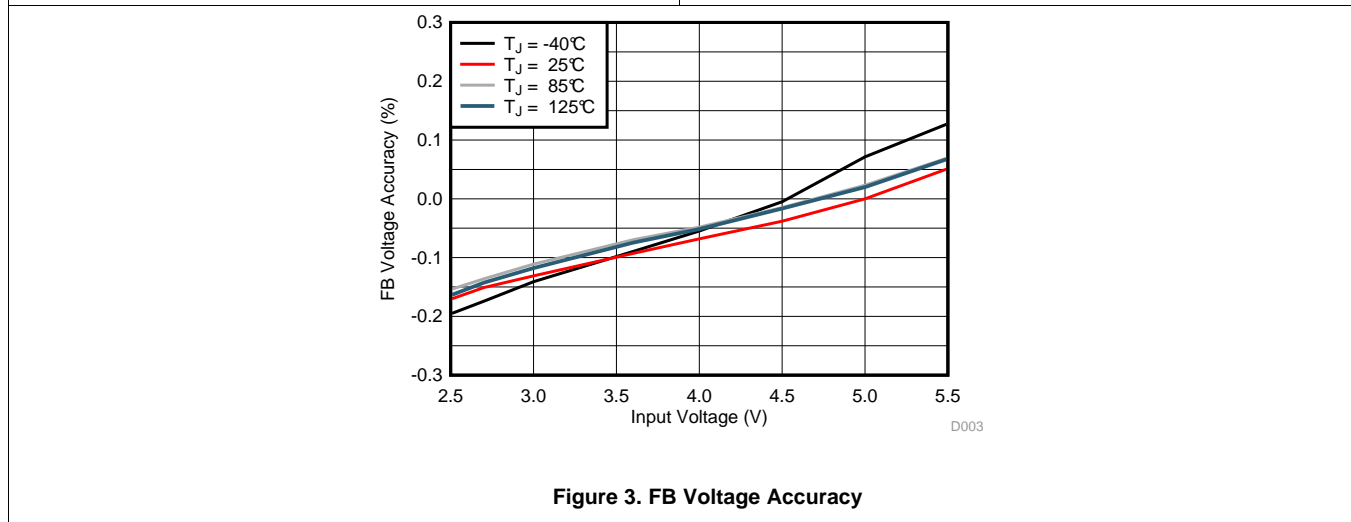

Figure 3. FB Voltage Accuracy

Feature Description (continued)

The TLV62568 is able to start into a pre-biased output capacitor. The converter starts with the applied bias voltage and ramps the output voltage to its nominal value.

8.3.4 Switch Current Limit

The switch current limit prevents the device from high inductor current and drawing excessive current from a battery or input voltage rail. Excessive current might occur with a heavy load or shorted output circuit condition. The TLV62568 adopts the peak current control by sensing the current of the high-side switch. Once the high-side switch current limit is reached, the high-side switch is turned off and low-side switch is turned on to ramp down the inductor current with an adaptive off-time.

8.3.5 Under Voltage Lockout

To avoid mis-operation of the device at low input voltages, under voltage lockout is implemented that shuts down the device at voltages lower than V_{UVLO} with V_{HYS_UVLO} hysteresis.

8.3.6 Thermal Shutdown

The device enters thermal shutdown once the junction temperature exceeds the thermal shutdown rising threshold, T_{JSD} . Once the junction temperature falls below the falling threshold, the device returns to normal operation automatically.

8.4 Device Functional Modes

8.4.1 Enabling/Disabling the Device

The device is enabled by setting the EN input to a logic High. Accordingly, a logic Low disables the device. If the device is enabled, the internal power stage starts switching and regulates the output voltage to the set point voltage. The EN input must be terminated and should not be left floating.

8.4.2 Power Good

The TLV62568P has a power good output. The PG pin goes high impedance once the output is above 95% of the nominal voltage, and is driven low once the output voltage falls below typically 90% of the nominal voltage. The PG pin is an open-drain output and is specified to sink up to 1 mA. The power good output requires a pull-up resistor connecting to any voltage rail less than 5.5 V. The PG signal can be used for sequencing of multiple rails by connecting it to the EN pin of other converters. Leave the PG pin unconnected when not used.

Table 1. PG Pin Logic

DEVICE CONDITIONS		LOGIC STATUS	
		HIGH Z	LOW
Enable	EN = High, $V_{FB} \geq V_{PG}$	√	
	EN = High, $V_{FB} \leq V_{PG}$		√
Shutdown	EN = Low		√
Thermal Shutdown	$T_J > T_{JSD}$		√
UVLO	$1.4\text{ V} < V_{IN} < V_{UVLO}$		√
Power Supply Removal	$V_{IN} \leq 1.4\text{ V}$	√	

9 Application and Implementation

NOTE

Information in the following applications sections is not part of the TI component specification, and TI does not warrant its accuracy or completeness. TI's customers are responsible for determining suitability of components for their purposes. Customers should validate and test their design implementation to confirm system functionality.

9.1 Application Information

The following section discusses the design of the external components to complete the power supply design for several input and output voltage options by using typical applications as a reference.

9.2 Typical Application

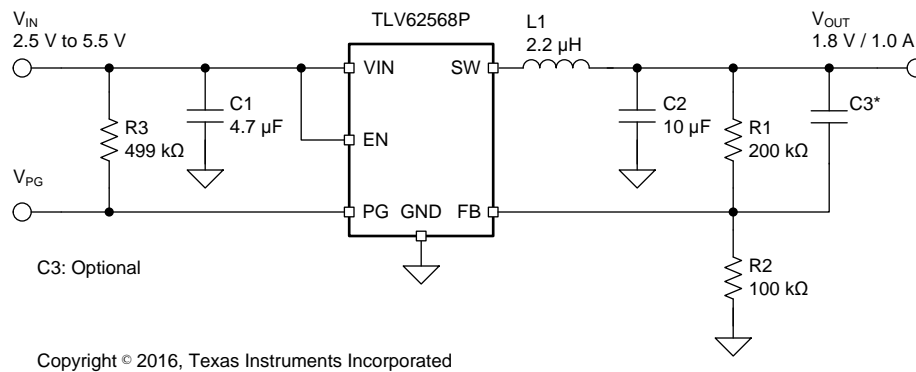

Figure 5. TLV62568 1.8-V Output Application

9.2.1 Design Requirements

For this design example, use the parameters listed in [Table 2](#) as the input parameters.

Table 2. Design Parameters

DESIGN PARAMETER	EXAMPLE VALUE
Input voltage	2.5 V to 5.5 V
Output voltage	1.8 V
Maximum output current	1.0 A

[Table 3](#) lists the components used for the example.

Table 3. List of Components

REFERENCE	DESCRIPTION	MANUFACTURER ⁽¹⁾
C1	4.7 μF, Ceramic Capacitor, 10 V, X7R, size 0805, GRM21BR71A475KA73L	Murata
C2	10 μF, Ceramic Capacitor, 10 V, X7R, size 0805, GRM21BR71A106KE51L	Murata
L1	2.2 μH, Power Inductor, SDER041H-2R2MS	Cyntec
R1,R2,R3	Chip resistor, 1%, size 0603	Std.
C3	Optional, 6.8 pF if it is needed	Std.

(1) See [Third-party Products Disclaimer](#)

9.2.2 Detailed Design Procedure

9.2.2.1 Setting the Output Voltage

An external resistor divider is used to set output voltage according to [Equation 2](#).

When sizing R2, in order to achieve low current consumption and acceptable noise sensitivity, use a maximum of 200 kΩ for R2. Larger currents through R2 improve noise sensitivity and output voltage accuracy but increase current consumption.

$$V_{OUT} = V_{FB} \times \left(1 + \frac{R1}{R2}\right) = 0.6V \times \left(1 + \frac{R1}{R2}\right) \quad (2)$$

A feed forward capacitor, C3 improves the loop bandwidth to make a fast transient response (shown in [Figure 19](#)). 6.8-pF capacitance is recommended for R2 of 100-kΩ resistance. A more detailed discussion on the optimization for stability vs. transient response can be found in [SLVA289](#).

9.2.2.2 Output Filter Design

The inductor and output capacitor together provide a low-pass filter. To simplify this process, [Table 4](#) outlines possible inductor and capacitor value combinations. Checked cells represent combinations that are proven for stability by simulation and lab test. Further combinations should be checked for each individual application.

Table 4. Matrix of Output Capacitor and Inductor Combinations

V _{OUT} [V]	L [μH] ⁽¹⁾	C _{OUT} [μF] ⁽²⁾				
		4.7	10	22	2x 22	100
0.6 ≤ V _{OUT} < 1.2	1				+	
	2.2				++ ⁽³⁾	
1.2 ≤ V _{OUT} < 1.8	1			+	+	
	2.2			++ ⁽³⁾	+	
1.8 ≤ V _{OUT}	1		+	+	+	
	2.2		++ ⁽³⁾	+	+	

(1) Inductor tolerance and current de-rating is anticipated. The effective inductance can vary by +20% and -30%.

(2) Capacitor tolerance and bias voltage de-rating is anticipated. The effective capacitance can vary by +20% and -50%.

(3) This LC combination is the standard value and recommended for most applications.

9.2.2.3 Inductor Selection

The main parameters for inductor selection is inductor value and then saturation current of the inductor. To calculate the maximum inductor current under static load conditions, [Equation 3](#) is given:

$$I_{L,MAX} = I_{OUT,MAX} + \frac{\Delta I_L}{2}$$

$$\Delta I_L = V_{OUT} \times \frac{1 - \frac{V_{OUT}}{V_{IN}}}{L \times f_{SW}}$$

where:

- I_{OUT,MAX} is the maximum output current
- ΔI_L is the inductor current ripple
- f_{SW} is the switching frequency
- L is the inductor value

(3)

It is recommended to choose a saturation current for the inductor that is approximately 20% to 30% higher than I_{L,MAX}. In addition, DC resistance and size should also be taken into account when selecting an appropriate inductor.

9.2.2.4 Input and Output Capacitor Selection

The architecture of the TLV62568 allows use of tiny ceramic-type output capacitors with low equivalent series resistance (ESR). These capacitors provide low output voltage ripple and are thus recommended. To keep its resistance up to high frequencies and to achieve narrow capacitance variation with temperature, it is recommended to use X7R or X5R dielectric.

The input capacitor is the low impedance energy source for the converter that helps provide stable operation. A low ESR multilayer ceramic capacitor is recommended for best filtering. For most applications, 4.7- μ F input capacitance is sufficient; a larger value reduces input voltage ripple.

The TLV62568 is designed to operate with an output capacitor of 10 μ F to 47 μ F, as outlined in [Table 4](#).

9.2.3 Application Performance Curves

$V_{IN} = 5\text{ V}$, $V_{OUT} = 1.8\text{ V}$, $L = 2.2\ \mu\text{H}$, $T_A = 25\text{ }^\circ\text{C}$, unless otherwise noted.

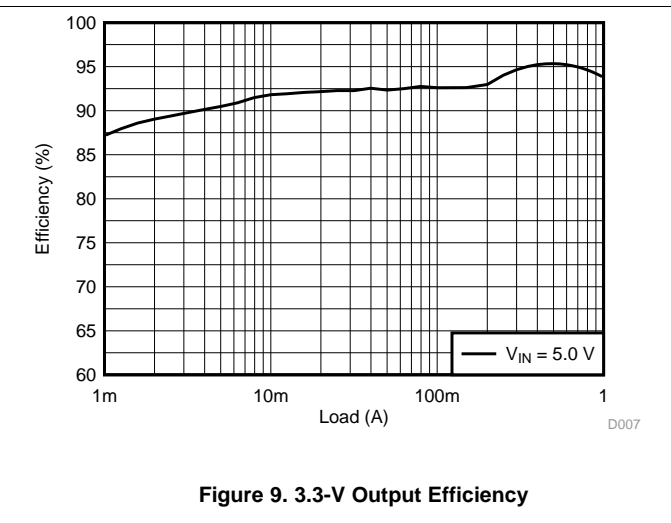
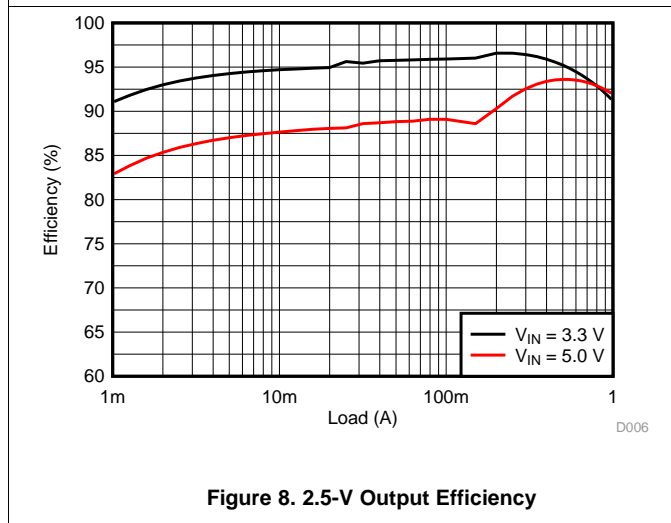
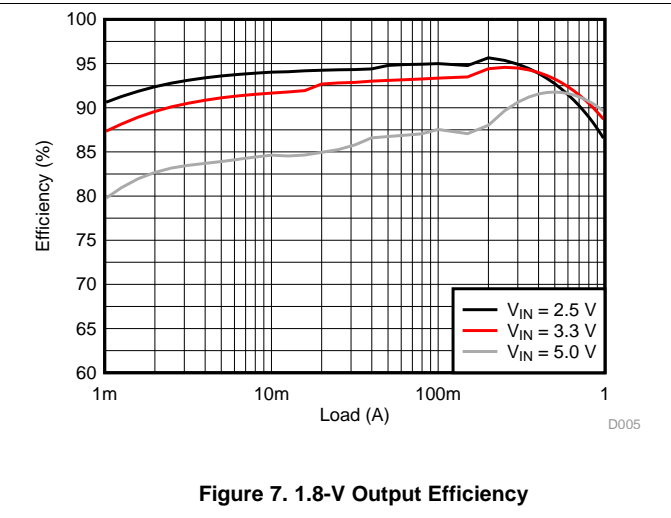
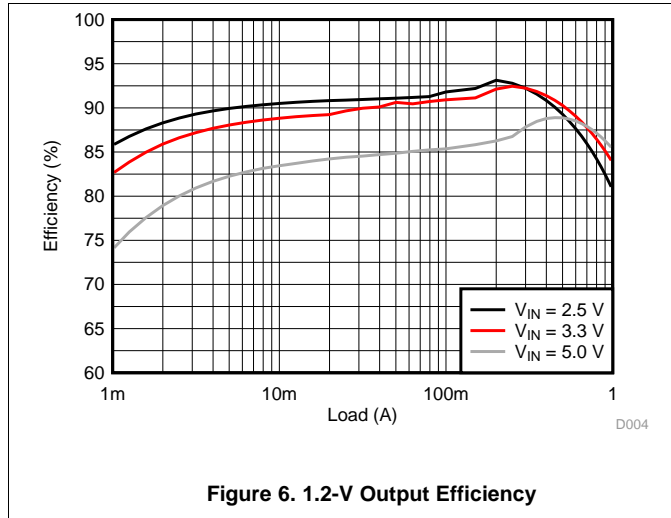

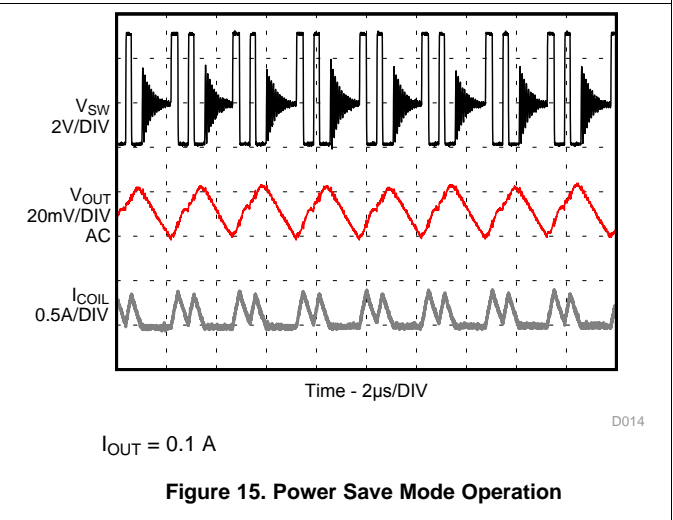
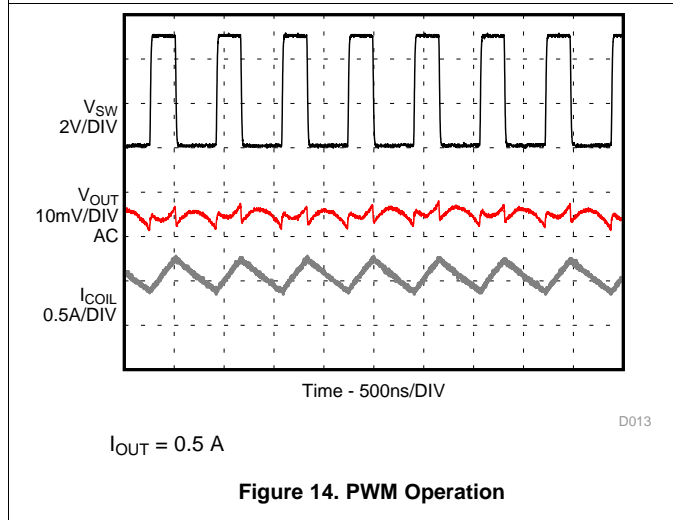
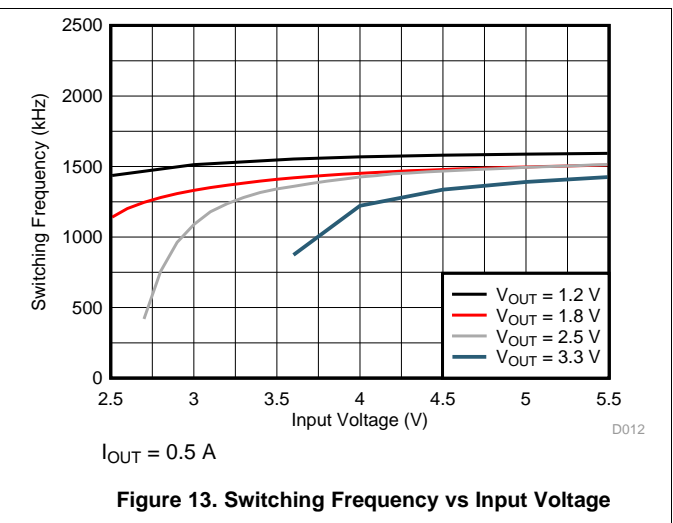
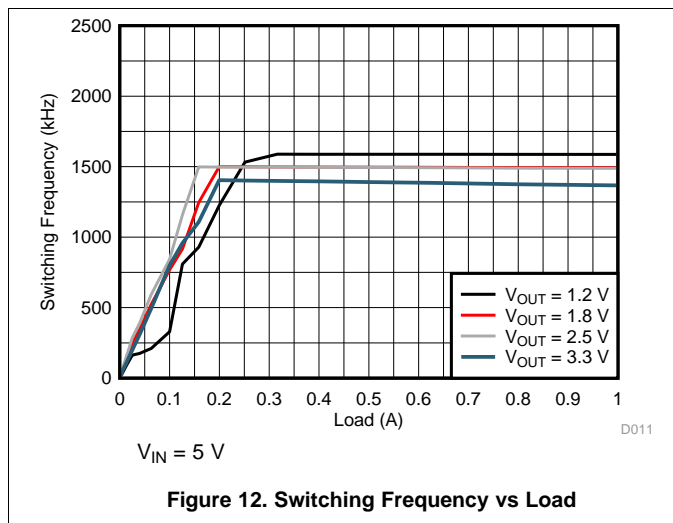
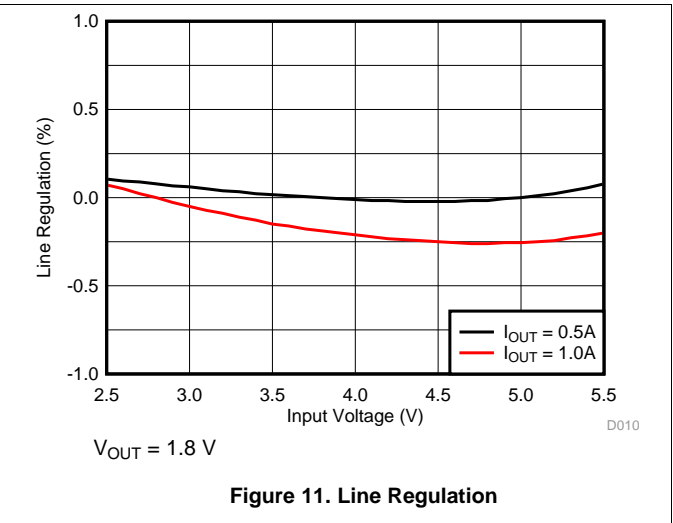
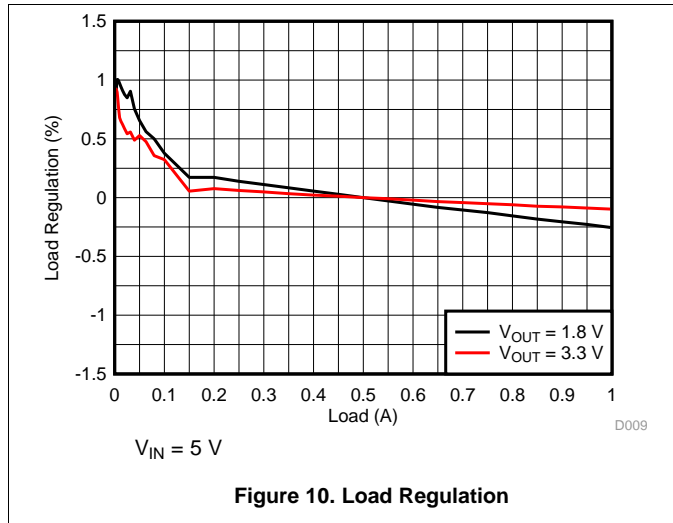

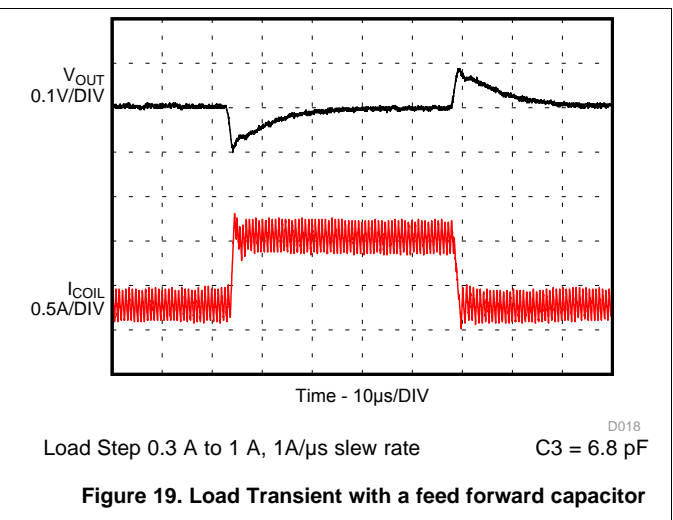
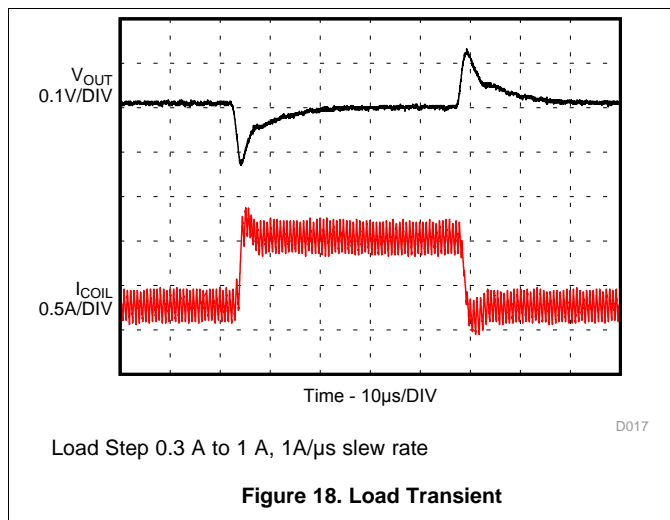
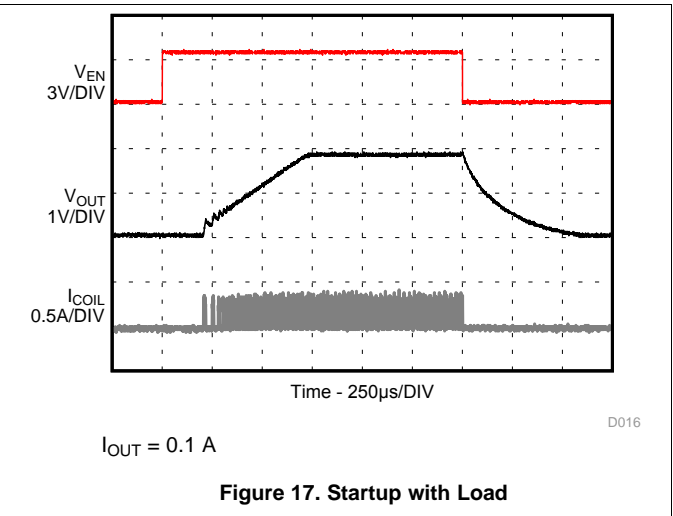
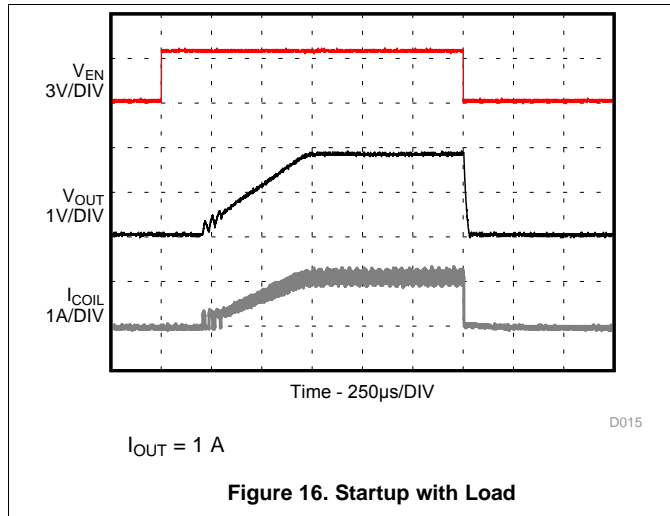

10 Power Supply Recommendations

The power supply to the TLV62568 must have a current rating according to the supply voltage, output voltage and output current.

11 Layout

11.1 Layout Guidelines

The PCB layout is an important step to maintain the high performance of the TLV62568 device.

- The input/output capacitors and the inductor should be placed as close as possible to the IC. This keeps the power traces short. Routing these power traces direct and wide results in low trace resistance and low parasitic inductance.
- The low side of the input and output capacitors must be connected properly to the power GND to avoid a GND potential shift.
- The sense traces connected to FB are signal traces. Special care should be taken to avoid noise being induced. Keep these traces away from SW nodes.
- GND layers might be used for shielding.

11.2 Layout Example

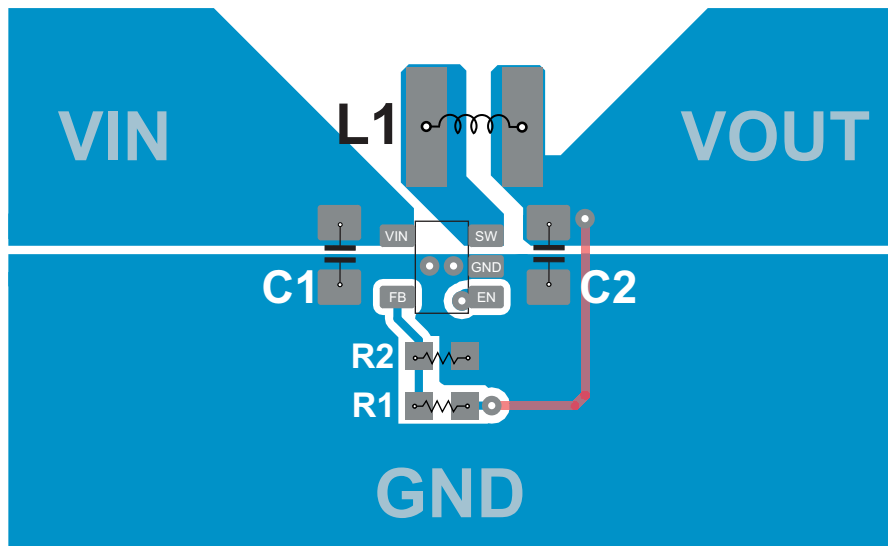

Figure 20. TLV62568 Layout

11.3 Thermal Considerations

Implementation of integrated circuits in low-profile and fine-pitch surface-mount packages typically requires special attention to power dissipation. Many system-dependent issues such as thermal coupling, airflow, convection surfaces, and the presence of other heat-generating components affect the power dissipation limits of a given component.

Two basic approaches for enhancing thermal performance are listed below:

- Improving the power dissipation capability of the PCB design
- Introducing airflow in the system

For more details on how to use the thermal parameters, see the application notes: Thermal Characteristics Application Notes [SZZA017](#) and [SPRA953](#).

12 Device and Documentation Support

12.1 Device Support

12.1.1 Third-Party Products Disclaimer

TI'S PUBLICATION OF INFORMATION REGARDING THIRD-PARTY PRODUCTS OR SERVICES DOES NOT CONSTITUTE AN ENDORSEMENT REGARDING THE SUITABILITY OF SUCH PRODUCTS OR SERVICES OR A WARRANTY, REPRESENTATION OR ENDORSEMENT OF SUCH PRODUCTS OR SERVICES, EITHER ALONE OR IN COMBINATION WITH ANY TI PRODUCT OR SERVICE.

12.2 Documentation Support

12.2.1 Related Documentation

Semiconductor and IC Package Thermal Metrics Application Report ([SPRA953](#))

Thermal Characteristics of Linear and Logic Packages Using JEDEC PCB Designs Application Report ([SZZA017](#))

12.3 Receiving Notification of Documentation Updates

To receive notification of documentation updates, navigate to the device product folder on ti.com. In the upper right corner, click on *Alert me* to register and receive a weekly digest of any product information that has changed. For change details, review the revision history included in any revised document.

12.4 Community Resources

The following links connect to TI community resources. Linked contents are provided "AS IS" by the respective contributors. They do not constitute TI specifications and do not necessarily reflect TI's views; see TI's [Terms of Use](#).

TI E2E™ Online Community *TI's Engineer-to-Engineer (E2E) Community*. Created to foster collaboration among engineers. At e2e.ti.com, you can ask questions, share knowledge, explore ideas and help solve problems with fellow engineers.

Design Support *TI's Design Support* Quickly find helpful E2E forums along with design support tools and contact information for technical support.

12.5 Trademarks

E2E is a trademark of Texas Instruments.
All other trademarks are the property of their respective owners.

12.6 Electrostatic Discharge Caution



These devices have limited built-in ESD protection. The leads should be shorted together or the device placed in conductive foam during storage or handling to prevent electrostatic damage to the MOS gates.

12.7 Glossary

[SLYZ022](#) — *TI Glossary*.

This glossary lists and explains terms, acronyms, and definitions.

13 Mechanical, Packaging, and Orderable Information

The following pages include mechanical, packaging, and orderable information. This information is the most current data available for the designated devices. This data is subject to change without notice and revision of this document. For browser-based versions of this data sheet, refer to the left-hand navigation.

PACKAGING INFORMATION

Orderable Device	Status (1)	Package Type	Package Drawing	Pins	Package Qty	Eco Plan (2)	Lead/Ball Finish (6)	MSL Peak Temp (3)	Op Temp (°C)	Device Marking (4/5)	Samples
TLV62568DBVR	ACTIVE	SOT-23	DBV	5	3000	Green (RoHS & no Sb/Br)	CU NIPDAU	Level-1-260C-UNLIM	-40 to 125	14VF	Samples
TLV62568DBVT	ACTIVE	SOT-23	DBV	5	250	Green (RoHS & no Sb/Br)	CU NIPDAU	Level-1-260C-UNLIM	-40 to 125	14VF	Samples
TLV62568DRLR	PREVIEW	SOT-OTHER	DRL	6	3000	TBD	Call TI	Call TI	-40 to 125		
TLV62568DRLT	PREVIEW	SOT-OTHER	DRL	6	250	TBD	Call TI	Call TI	-40 to 125		
TLV62568PDRLR	PREVIEW	SOT-OTHER	DRL	6	3000	TBD	Call TI	Call TI	-40 to 125		
TLV62568PDRLT	PREVIEW	SOT-OTHER	DRL	6	250	TBD	Call TI	Call TI	-40 to 125		

(1) The marketing status values are defined as follows:

ACTIVE: Product device recommended for new designs.

LIFEBUY: TI has announced that the device will be discontinued, and a lifetime-buy period is in effect.

NRND: Not recommended for new designs. Device is in production to support existing customers, but TI does not recommend using this part in a new design.

PREVIEW: Device has been announced but is not in production. Samples may or may not be available.

OBSOLETE: TI has discontinued the production of the device.

(2) Eco Plan - The planned eco-friendly classification: Pb-Free (RoHS), Pb-Free (RoHS Exempt), or Green (RoHS & no Sb/Br) - please check <http://www.ti.com/productcontent> for the latest availability information and additional product content details.

TBD: The Pb-Free/Green conversion plan has not been defined.

Pb-Free (RoHS): TI's terms "Lead-Free" or "Pb-Free" mean semiconductor products that are compatible with the current RoHS requirements for all 6 substances, including the requirement that lead not exceed 0.1% by weight in homogeneous materials. Where designed to be soldered at high temperatures, TI Pb-Free products are suitable for use in specified lead-free processes.

Pb-Free (RoHS Exempt): This component has a RoHS exemption for either 1) lead-based flip-chip solder bumps used between the die and package, or 2) lead-based die adhesive used between the die and leadframe. The component is otherwise considered Pb-Free (RoHS compatible) as defined above.

Green (RoHS & no Sb/Br): TI defines "Green" to mean Pb-Free (RoHS compatible), and free of Bromine (Br) and Antimony (Sb) based flame retardants (Br or Sb do not exceed 0.1% by weight in homogeneous material)

(3) MSL, Peak Temp. - The Moisture Sensitivity Level rating according to the JEDEC industry standard classifications, and peak solder temperature.

(4) There may be additional marking, which relates to the logo, the lot trace code information, or the environmental category on the device.

(5) Multiple Device Markings will be inside parentheses. Only one Device Marking contained in parentheses and separated by a "-" will appear on a device. If a line is indented then it is a continuation of the previous line and the two combined represent the entire Device Marking for that device.

(6) Lead/Ball Finish - Orderable Devices may have multiple material finish options. Finish options are separated by a vertical ruled line. Lead/Ball Finish values may wrap to two lines if the finish value exceeds the maximum column width.

Important Information and Disclaimer: The information provided on this page represents TI's knowledge and belief as of the date that it is provided. TI bases its knowledge and belief on information provided by third parties, and makes no representation or warranty as to the accuracy of such information. Efforts are underway to better integrate information from third parties. TI has taken and continues to take reasonable steps to provide representative and accurate information but may not have conducted destructive testing or chemical analysis on incoming materials and chemicals. TI and TI suppliers consider certain information to be proprietary, and thus CAS numbers and other limited information may not be available for release.

In no event shall TI's liability arising out of such information exceed the total purchase price of the TI part(s) at issue in this document sold by TI to Customer on an annual basis.

TAPE AND REEL INFORMATION

QUADRANT ASSIGNMENTS FOR PIN 1 ORIENTATION IN TAPE

*All dimensions are nominal

Device	Package Type	Package Drawing	Pins	SPQ	Reel Diameter (mm)	Reel Width W1 (mm)	A0 (mm)	B0 (mm)	K0 (mm)	P1 (mm)	W (mm)	Pin1 Quadrant
TLV62568DBVR	SOT-23	DBV	5	3000	180.0	8.4	3.2	3.2	1.4	4.0	8.0	Q3
TLV62568DBVT	SOT-23	DBV	5	250	180.0	8.4	3.2	3.2	1.4	4.0	8.0	Q3

TAPE AND REEL BOX DIMENSIONS

*All dimensions are nominal

Device	Package Type	Package Drawing	Pins	SPQ	Length (mm)	Width (mm)	Height (mm)
TLV62568DBVR	SOT-23	DBV	5	3000	210.0	185.0	35.0
TLV62568DBVT	SOT-23	DBV	5	250	210.0	185.0	35.0

DBV (R-PDSO-G5)

PLASTIC SMALL-OUTLINE PACKAGE



- NOTES:
- All linear dimensions are in millimeters.
 - This drawing is subject to change without notice.
 - Body dimensions do not include mold flash or protrusion. Mold flash and protrusion shall not exceed 0.15 per side.
 - Falls within JEDEC MO-178 Variation AA.

DRL (R-PDSO-N6)

PLASTIC SMALL OUTLINE

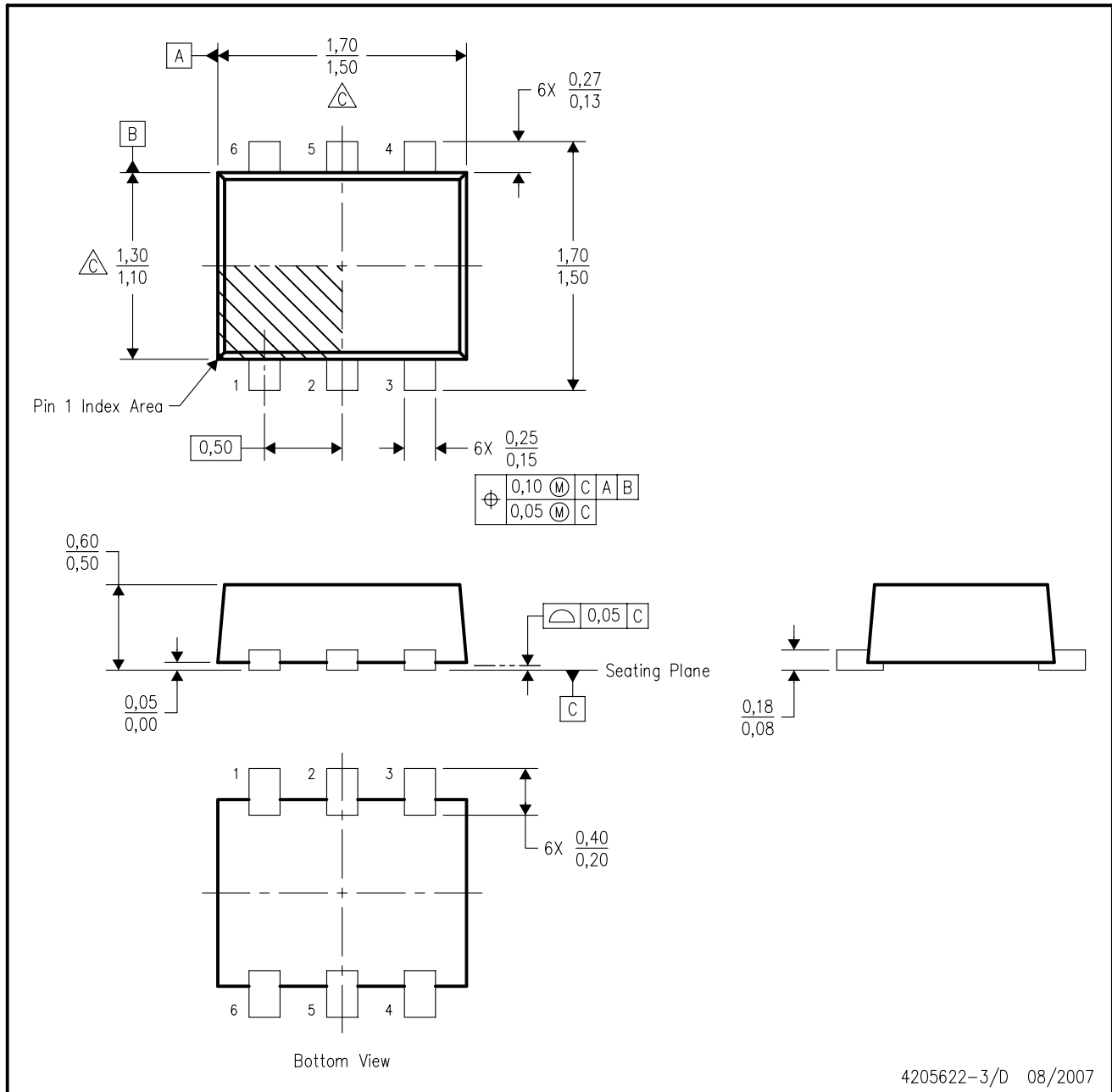

4205622-3/D 08/2007

- NOTES:
- A. All linear dimensions are in millimeters. Dimensioning and tolerancing per ASME Y14.5M-1994.
 - B. This drawing is subject to change without notice.
 - C. Body dimensions do not include mold flash, interlead flash, protrusions, or gate burrs. Mold flash, interlead flash, protrusions, or gate burrs shall not exceed 0,15 per end or side.
 - D. JEDEC package registration is pending.

IMPORTANT NOTICE FOR TI DESIGN INFORMATION AND RESOURCES

Texas Instruments Incorporated ("TI") technical, application or other design advice, services or information, including, but not limited to, reference designs and materials relating to evaluation modules, (collectively, "TI Resources") are intended to assist designers who are developing applications that incorporate TI products; by downloading, accessing or using any particular TI Resource in any way, you (individually or, if you are acting on behalf of a company, your company) agree to use it solely for this purpose and subject to the terms of this Notice.

TI's provision of TI Resources does not expand or otherwise alter TI's applicable published warranties or warranty disclaimers for TI products, and no additional obligations or liabilities arise from TI providing such TI Resources. TI reserves the right to make corrections, enhancements, improvements and other changes to its TI Resources.

You understand and agree that you remain responsible for using your independent analysis, evaluation and judgment in designing your applications and that you have full and exclusive responsibility to assure the safety of your applications and compliance of your applications (and of all TI products used in or for your applications) with all applicable regulations, laws and other applicable requirements. You represent that, with respect to your applications, you have all the necessary expertise to create and implement safeguards that (1) anticipate dangerous consequences of failures, (2) monitor failures and their consequences, and (3) lessen the likelihood of failures that might cause harm and take appropriate actions. You agree that prior to using or distributing any applications that include TI products, you will thoroughly test such applications and the functionality of such TI products as used in such applications. TI has not conducted any testing other than that specifically described in the published documentation for a particular TI Resource.

You are authorized to use, copy and modify any individual TI Resource only in connection with the development of applications that include the TI product(s) identified in such TI Resource. NO OTHER LICENSE, EXPRESS OR IMPLIED, BY ESTOPPEL OR OTHERWISE TO ANY OTHER TI INTELLECTUAL PROPERTY RIGHT, AND NO LICENSE TO ANY TECHNOLOGY OR INTELLECTUAL PROPERTY RIGHT OF TI OR ANY THIRD PARTY IS GRANTED HEREIN, including but not limited to any patent right, copyright, mask work right, or other intellectual property right relating to any combination, machine, or process in which TI products or services are used. Information regarding or referencing third-party products or services does not constitute a license to use such products or services, or a warranty or endorsement thereof. Use of TI Resources may require a license from a third party under the patents or other intellectual property of the third party, or a license from TI under the patents or other intellectual property of TI.

TI RESOURCES ARE PROVIDED "AS IS" AND WITH ALL FAULTS. TI DISCLAIMS ALL OTHER WARRANTIES OR REPRESENTATIONS, EXPRESS OR IMPLIED, REGARDING TI RESOURCES OR USE THEREOF, INCLUDING BUT NOT LIMITED TO ACCURACY OR COMPLETENESS, TITLE, ANY EPIDEMIC FAILURE WARRANTY AND ANY IMPLIED WARRANTIES OF MERCHANTABILITY, FITNESS FOR A PARTICULAR PURPOSE, AND NON-INFRINGEMENT OF ANY THIRD PARTY INTELLECTUAL PROPERTY RIGHTS.

TI SHALL NOT BE LIABLE FOR AND SHALL NOT DEFEND OR INDEMNIFY YOU AGAINST ANY CLAIM, INCLUDING BUT NOT LIMITED TO ANY INFRINGEMENT CLAIM THAT RELATES TO OR IS BASED ON ANY COMBINATION OF PRODUCTS EVEN IF DESCRIBED IN TI RESOURCES OR OTHERWISE. IN NO EVENT SHALL TI BE LIABLE FOR ANY ACTUAL, DIRECT, SPECIAL, COLLATERAL, INDIRECT, PUNITIVE, INCIDENTAL, CONSEQUENTIAL OR EXEMPLARY DAMAGES IN CONNECTION WITH OR ARISING OUT OF TI RESOURCES OR USE THEREOF, AND REGARDLESS OF WHETHER TI HAS BEEN ADVISED OF THE POSSIBILITY OF SUCH DAMAGES.

You agree to fully indemnify TI and its representatives against any damages, costs, losses, and/or liabilities arising out of your non-compliance with the terms and provisions of this Notice.

This Notice applies to TI Resources. Additional terms apply to the use and purchase of certain types of materials, TI products and services. These include; without limitation, TI's standard terms for semiconductor products (<http://www.ti.com/sc/docs/stdterms.htm>), [evaluation modules](#), and [samples](http://www.ti.com/sc/docs/sampterm.htm) (<http://www.ti.com/sc/docs/sampterm.htm>).

Mailing Address: Texas Instruments, Post Office Box 655303, Dallas, Texas 75265
Copyright © 2017, Texas Instruments Incorporated