

TPS22969 5.5-V, 6-A, 4.4-mΩ On-Resistance Load Switch

1 Features

- Integrated Single Channel Load Switch
- VBIAS Voltage Range: 2.5 V to 5.5 V
- VIN Voltage Range: 0.8 V to 5.5 V
- Ultra Low R_{ON} Resistance
 - R_{ON} = 4.4 mΩ at V_{IN} = 1.05 V (V_{BIAS} = 5 V)
- 6 A Maximum Continuous Switch Current
- Low Quiescent Current
 - (20 μA (Typ) for V_{BIAS} = 5 V)
- Low Shutdown Current
 - (1 μA (Typ) for V_{BIAS} = 5 V)
- Low Control Input Threshold Enables Use of 1.2 V or Higher GPIO
- Controlled and Fixed Slew Rate Across V_{BIAS} and V_{IN}
 - t_R = 599 μs at V_{IN} = 1.05 V (V_{BIAS} = 5 V)
- Quick Output Discharge (QOD)
- SON 8-Pin Package with Thermal Pad
- ESD Performance Tested per JESD 22
 - 2-kV Human-Body Model (HBM)
 - 1-kV Charged-Device Model (CDM)

2 Applications

- Ultrabook™/Notebooks
- Desktop PC
- Industrial PC
- Chromebook
- Servers
- Set-top Boxes
- Telecom Systems
- Tablet PC

Driving High Current Core Rails For a Processor

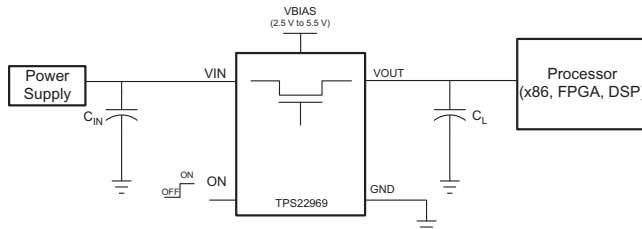

3 Description

The TPS22969 is a small, ultra-low R_{ON}, single channel load switch with controlled turn on. The device contains an N-channel MOSFET that can operate over an input voltage range of 0.8 V to 5.5 V and can support a maximum continuous current of 6 A.

The combination of ultra-low R_{ON} and high current capability of the device makes it ideal for driving processor rails with very tight voltage dropout tolerances. The controlled rise time of the device greatly reduces inrush current caused by large bulk load capacitances, thereby reducing or eliminating voltage droop on the power supply. The switch can be independently controlled via the ON pin, which is capable of interfacing directly with low-voltage control signals originating from microcontrollers or low voltage discrete logic. The device further reduces the total solution size by integrating a 224-Ω pull-down resistor for quick output discharge (QOD) when the switch is turned off.

The TPS22969 is available in a small 3.00 mm x 3.00 mm SON-8 package (DNY). The DNY package integrates a thermal pad which allows for high power dissipation in high current and high temperature applications. The device is characterized for operation over the free-air temperature range of –40°C to 105°C.

Device Information⁽¹⁾

ORDER NUMBER	PACKAGE	BODY SIZE (NOM)
TPS22969	WSON (8)	3.00 mm x 3.00 mm

(1) For all available packages, see the orderable addendum at the end of the datasheet.

R_{ON} vs V_{IN} (V_{BIAS} = 5 V, I_{OUT} = –200 mA)

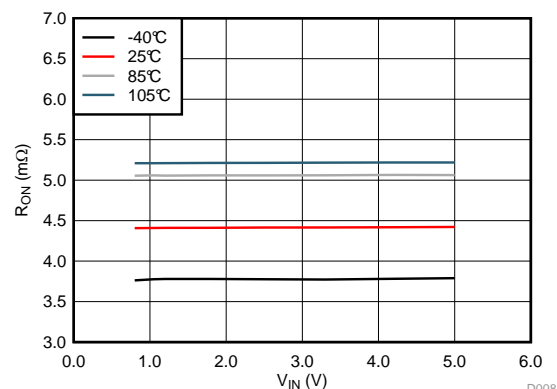

D008



Table of Contents

1 Features	1	7.2 Functional Block Diagram	14
2 Applications	1	7.3 Feature Description	15
3 Description	1	8 Applications and Implementation	16
4 Revision History	2	8.1 Application Information	16
5 Pin Configuration and Functions	3	8.2 Typical Application	16
6 Specifications	3	9 Power Supply Recommendations	19
6.1 Absolute Maximum Ratings	3	10 Layout	19
6.2 ESD Ratings	4	10.1 Layout Guidelines	19
6.3 Recommended Operating Conditions	4	10.2 Layout Example	20
6.4 Thermal Information	4	11 Device and Documentation Support	21
6.5 Electrical Characteristics, $V_{BIAS} = 5.0\text{ V}$	5	11.1 Community Resources	21
6.6 Electrical Characteristics, $V_{BIAS} = 2.5\text{ V}$	6	11.2 Trademarks	21
6.7 Switching Characteristics	7	11.3 Electrostatic Discharge Caution	21
6.8 Typical Characteristics	9	11.4 Glossary	21
7 Detailed Description	14	12 Mechanical, Packaging, and Orderable Information	21
7.1 Overview	14		

4 Revision History

NOTE: Page numbers for previous revisions may differ from page numbers in the current version.

Changes from Revision A (February 2014) to Revision B Page

- Updated T_A ratings in datasheet from 85°C to 105°C. **1**

Changes from Original (February 2014) to Revision A Page

- Initial release of full version. **1**

5 Pin Configuration and Functions

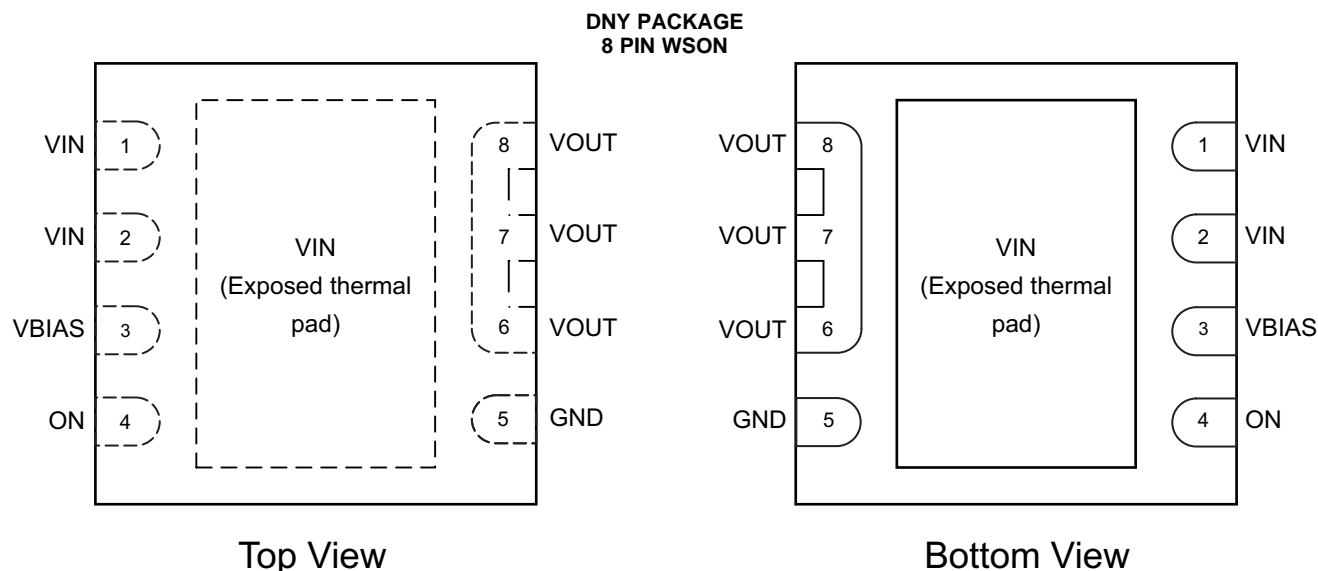

Pin Functions

Pin		I/O	DESCRIPTION
NAME	NO.		
VIN	1, 2	I	Switch input. Place ceramic bypass capacitor(s) between this pin and GND. See the Detailed Description section for more information.
VIN	Exposed thermal Pad	I	Switch input. Place ceramic bypass capacitor(s) between this pin and GND. See the Detailed Description section for more information.
VBIAS	3	I	Bias voltage. Power supply to the device.
ON	4	I	Active high switch control input. Do not leave floating.
GND	5	–	Ground.
VOUT	6, 7, 8	O	Switch output. Place ceramic bypass capacitor(s) between this pin and GND. See the Detailed Description section for more information.

6 Specifications

6.1 Absolute Maximum Ratings

Over operating free-air temperature range (unless otherwise noted) ⁽¹⁾

		MIN	MAX	UNIT
V_{IN}	Input voltage range	–0.3	6	V
V_{BIAS}	Bias voltage range	–0.3	6	V
V_{OUT}	Output voltage range	–0.3	6	V
V_{ON}	ON pin voltage range	–0.3	6	V
I_{MAX}	Maximum Continuous Switch Current		6	A
I_{PLS}	Maximum Pulsed Switch Current, pulse < 300- μ s, 2% duty cycle		8	A
T_A	Operating free-air temperature range	–40	105	°C
T_J	Maximum junction temperature		125	°C
T_{STG}	Storage temperature range	–65	150	°C

- (1) Stresses beyond those listed under *Absolute Maximum Ratings* may cause permanent damage to the device. These are stress ratings only, which do not imply functional operation of the device at these or any other conditions beyond those indicated under [Recommended Operating Conditions](#). Exposure to absolute-maximum-rated conditions for extended periods may affect device reliability.

6.2 ESD Ratings

		VALUE	UNIT
$V_{(ESD)}$ Electrostatic discharge	Human-body model (HBM), per ANSI/ESDA/JEDEC JS-001 ⁽¹⁾	±2000	V
	Charged-device model (CDM), per JEDEC specification JESD22-C101 ⁽²⁾	±1000	

- (1) JEDEC document JEP155 states that 500-V HBM allows safe manufacturing with a standard ESD control process. Manufacturing with less than 500-V HBM is possible with the necessary precautions.
- (2) JEDEC document JEP157 states that 250-V CDM allows safe manufacturing with a standard ESD control process. Manufacturing with less than 250-V CDM is possible with the necessary precautions.

6.3 Recommended Operating Conditions

Over operating free-air temperature range (unless otherwise noted)

		MIN	MAX	UNIT	
V_{IN}	Input voltage range	0.8	V_{BIAS}	V	
V_{BIAS}	Bias voltage range	2.5	5.5	V	
V_{ON}	ON voltage range	0	5.5	V	
V_{OUT}	Output voltage range		V_{IN}	V	
$V_{IH, ON}$	High-level voltage, ON	$V_{BIAS} = 2.5V$ to $5.5V$	1.2	5.5	V
$V_{IL, ON}$	Low-level voltage, ON	$V_{BIAS} = 2.5V$ to $5.5V$	0	0.5	V
C_{IN}	Input Capacitor	1 ⁽¹⁾		μF	

- (1) Refer to [Detailed Description](#) section.

6.4 Thermal Information

THERMAL METRIC ⁽¹⁾		TPS22969	UNIT
		DNY (WSON)	
		8 PINS	
$R_{\theta JA}$	Junction-to-ambient thermal resistance	44.6	°C/W
$R_{\theta Jctop}$	Junction-to-case (top) thermal resistance	44.4	°C/W
$R_{\theta JB}$	Junction-to-board thermal resistance	17.6	°C/W
ψ_{JT}	Junction-to-top characterization parameter	0.4	°C/W
ψ_{JB}	Junction-to-board characterization parameter	17.4	°C/W
$R_{\theta Jcbot}$	Junction-to-case (bottom) thermal resistance	1.1	°C/W

- (1) For more information about traditional and new thermal metrics, see the *IC Package Thermal Metrics* application report, [SPRA953](#).

6.5 Electrical Characteristics, $V_{BIAS} = 5.0\text{ V}$

Unless otherwise noted, the specification in the following table applies over the operating ambient temperature $-40^{\circ}\text{C} \leq T_A \leq 105^{\circ}\text{C}$. Typical values are for $T_A = 25^{\circ}\text{C}$ (unless otherwise noted).

PARAMETER		TEST CONDITIONS	T_A	MIN	TYP	MAX	UNIT				
CURRENTS AND THRESHOLDS											
$I_{Q, V_{BIAS}}$	V_{BIAS} quiescent current	$I_{OUT} = 0, V_{IN} = V_{BIAS}, V_{ON} = 5.0\text{ V}$	-40°C to 85°C		20.4	26.0	μA				
			-40°C to 105°C			27.0					
$I_{SD, V_{BIAS}}$	V_{BIAS} shutdown current	$V_{ON} = 0\text{ V}, V_{OUT} = 0\text{ V}$	-40°C to 85°C		1.1	1.5	μA				
			-40°C to 105°C			1.6					
$I_{SD, V_{IN}}$	V_{IN} shutdown current	$V_{ON} = 0\text{ V}, V_{OUT} = 0\text{ V}$	$V_{IN} = 5.0\text{ V}$	-40°C to 85°C			0.1	μA			
				-40°C to 105°C			0.5				
			$V_{IN} = 3.3\text{ V}$	-40°C to 85°C			0.1				
				-40°C to 105°C			0.5				
			$V_{IN} = 1.8\text{ V}$	-40°C to 85°C			0.1				
				-40°C to 105°C			0.5				
			$V_{IN} = 1.05\text{ V}$	-40°C to 85°C			0.1				
				-40°C to 105°C			0.5				
$V_{IN} = 0.8\text{ V}$	-40°C to 85°C			0.1							
	-40°C to 105°C			0.5							
I_{ON}	ON pin leakage current	$V_{ON} = 5.5\text{ V}$	-40°C to 105°C			0.1	μA				
$V_{HYS, ON}$	ON pin hysteresis	$V_{BIAS} = V_{IN}$	25°C		113		mV				
RESISTANCE CHARACTERISTICS											
R_{ON}	On-state resistance	$I_{OUT} = -200\text{ mA}, V_{BIAS} = 5.0\text{ V}$	$V_{IN} = 5.0\text{ V}$	25°C		4.4	5.0	m Ω			
				-40°C to 85°C			5.6				
				-40°C to 105°C			5.8				
			$V_{IN} = 3.3\text{ V}$	25°C		4.4	5.0	m Ω			
				-40°C to 85°C			5.6				
				-40°C to 105°C			5.8				
			$V_{IN} = 2.5\text{ V}$	25°C		4.4	5.0	m Ω			
				-40°C to 85°C			5.6				
				-40°C to 105°C			5.8				
			$V_{IN} = 1.8\text{ V}$	25°C		4.4	5.0	m Ω			
				-40°C to 85°C			5.6				
				-40°C to 105°C			5.8				
			$V_{IN} = 1.05\text{ V}$	25°C		4.4	5.0	m Ω			
				-40°C to 85°C			5.6				
				-40°C to 105°C			5.8				
			$V_{IN} = 0.8\text{ V}$	25°C		4.4	5.0	m Ω			
				-40°C to 85°C			5.6				
				-40°C to 105°C			5.8				
					$I_{OUT} = -6\text{ A}, V_{BIAS} = 5.0\text{ V}$	$V_{IN} = 1.05\text{ V}$	-40°C to 85°C		4.6	5.8 ⁽¹⁾	m Ω
							-40°C to 105°C			6.0 ⁽¹⁾	
R_{PD}	Output pulldown resistance	$V_{IN} = 5.0\text{ V}, V_{ON} = 0\text{ V}, V_{OUT} = 1\text{ V}$	-40°C to 105°C		224	233	Ω				

(1) Parameter verified by design and characterization, but not tested in production.

6.6 Electrical Characteristics, $V_{BIAS} = 2.5\text{ V}$

Unless otherwise noted, the specification in the following table applies over the operating ambient temperature $-40^{\circ}\text{C} \leq T_A \leq 105^{\circ}\text{C}$. Typical values are for $T_A = 25^{\circ}\text{C}$ unless otherwise noted.

PARAMETER		TEST CONDITIONS	T_A	MIN	TYP	MAX	UNIT	
CURRENTS AND THRESHOLDS								
$I_{Q, VBIAS}$	V_{BIAS} quiescent current	$I_{OUT} = 0, V_{IN} = V_{BIAS}, V_{ON} = 5.0\text{ V}$	-40°C to 85°C		9.9	12.5	μA	
			-40°C to 105°C			12.7		
$I_{SD, VBIAS}$	V_{BIAS} shutdown current	$V_{ON} = 0\text{ V}, V_{OUT} = 0\text{ V}$	-40°C to 85°C		0.5	0.65	μA	
			-40°C to 105°C			0.7		
$I_{SD, VIN}$	V_{IN} shutdown current	$V_{ON} = 0\text{ V}, V_{OUT} = 0\text{ V}$	$V_{IN} = 2.5\text{ V}$	-40°C to 85°C		0.1	μA	
				-40°C to 105°C		0.5		
			$V_{IN} = 1.8\text{ V}$	-40°C to 85°C		0.1		
				-40°C to 105°C		0.5		
			$V_{IN} = 1.05\text{ V}$	-40°C to 85°C		0.1		
				-40°C to 105°C		0.5		
$V_{IN} = 0.8\text{ V}$	-40°C to 85°C		0.1					
	-40°C to 105°C		0.5					
I_{ON}	ON pin input leakage current	$V_{ON} = 5.5\text{ V}$	-40°C to 105°C			0.1	μA	
$V_{HYS, ON}$	ON pin hysteresis	$V_{BIAS} = V_{IN}$	25°C		83		mV	
RESISTANCE CHARACTERISTICS								
R_{ON}	On-state resistance	$I_{OUT} = -200\text{ mA}, V_{BIAS} = 2.5\text{ V}$	$V_{IN} = 2.5\text{ V}$	25°C		4.7	5.3	m Ω
				-40°C to 85°C			6.0	
				-40°C to 105°C			6.2	
			$V_{IN} = 1.8\text{ V}$	25°C		4.6	5.2	m Ω
				-40°C to 85°C			5.8	
				-40°C to 105°C			6.0	
			$V_{IN} = 1.05\text{ V}$	25°C		4.5	5.1	m Ω
				-40°C to 85°C			5.7	
				-40°C to 105°C			5.9	
			$V_{IN} = 0.8\text{ V}$	25°C		4.5	5.1	m Ω
				-40°C to 85°C			5.7	
				-40°C to 105°C			5.9	
R_{PD}	Output pulldown resistance	$V_{IN} = 2.5\text{ V}, V_{ON} = 0\text{ V}, V_{OUT} = 1\text{ V}$	-40°C to 105°C		224	233	Ω	

6.7 Switching Characteristics

Refer to the timing test circuit in [Figure 1](#) (unless otherwise noted) for references to external components used for the test condition in the switching characteristics table. Switching characteristics shown below are only valid for the power-up sequence where VIN and VBIAS are already in steady state condition before the ON pin is asserted high.

PARAMETER		TEST CONDITION	MIN	TYP	MAX	UNIT
V_{IN} = 5 V, V_{ON} = V_{BIAS} = 5 V, T_A = 25°C (unless otherwise noted)						
t _{ON}	Turn-on time	R _L = 10 Ω, C _L = 0.1 μF		2397		μs
t _{OFF}	Turn-off time			4		
t _R	V _{OUT} rise time			2663		
t _F	V _{OUT} fall time			2		
t _D	Delay time			1009		
V_{IN} = 1.05 V, V_{ON} = V_{BIAS} = 5 V, T_A = 25°C (unless otherwise noted)						
t _{ON}	Turn-on time	R _L = 10 Ω, C _L = 0.1 μF		1064		μs
t _{OFF}	Turn-off time			4		
t _R	V _{OUT} rise time			599		
t _F	V _{OUT} fall time			2		
t _D	Delay time			727		
V_{IN} = 0.8 V, V_{ON} = V_{BIAS} = 5 V, T_A = 25°C (unless otherwise noted)						
t _{ON}	Turn-on time	R _L = 10 Ω, C _L = 0.1 μF		981		μs
t _{OFF}	Turn-off time			4		
t _R	V _{OUT} rise time			500		
t _F	V _{OUT} fall time			2		
t _D	Delay time			714		
V_{IN} = 2.5 V, V_{ON} = 5 V, V_{BIAS} = 2.5 V, T_A = 25°C (unless otherwise noted)						
t _{ON}	Turn-on time	R _L = 10 Ω, C _L = 0.1 μF		1576		μs
t _{OFF}	Turn-off time			8		
t _R	V _{OUT} rise time			1372		
t _F	V _{OUT} fall time			2		
t _D	Delay time			865		
V_{IN} = 1.05 V, V_{ON} = 5V, V_{BIAS} = 2.5 V, T_A = 25°C (unless otherwise noted)						
t _{ON}	Turn-on time	R _L = 10 Ω, C _L = 0.1 μF		1080		μs
t _{OFF}	Turn-off time			8		
t _R	V _{OUT} rise time			604		
t _F	V _{OUT} fall time			2		
t _D	Delay time			738		
V_{IN} = 0.8 V, V_{ON} = 5V, V_{BIAS} = 2.5 V, T_A = 25°C (unless otherwise noted)						
t _{ON}	Turn-on time	R _L = 10 Ω, C _L = 0.1 μF		994		μs
t _{OFF}	Turn-off time			8		
t _R	V _{OUT} rise time			502		
t _F	V _{OUT} fall time			2		
t _D	Delay time			723		

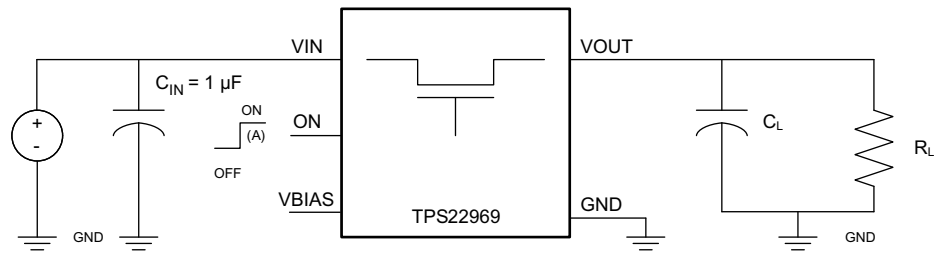

Timing Test Circuit

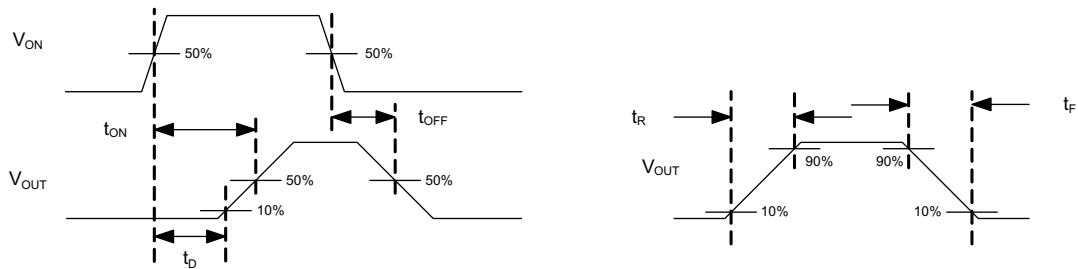

Timing Waveforms

(A) Rise and fall times of the control signal is 100 ns.

Figure 1. Switching Characteristics Measurement Setup and Definitions

6.8 Typical Characteristics

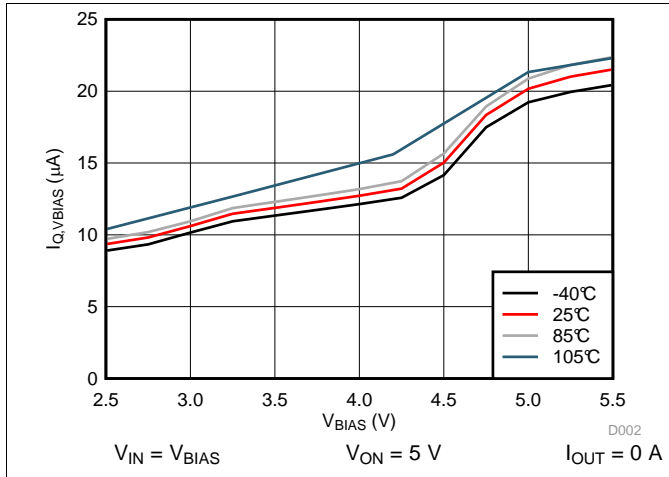

Figure 2. $I_{Q,VBIAS}$ vs V_{BIAS}

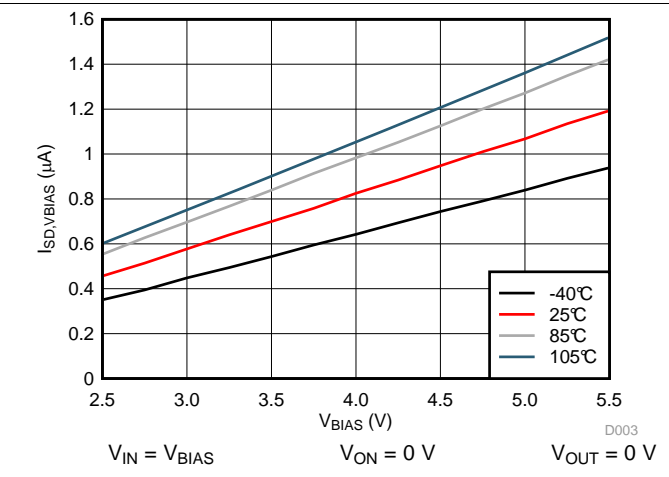

Figure 3. $I_{SD,VBIAS}$ vs V_{BIAS}

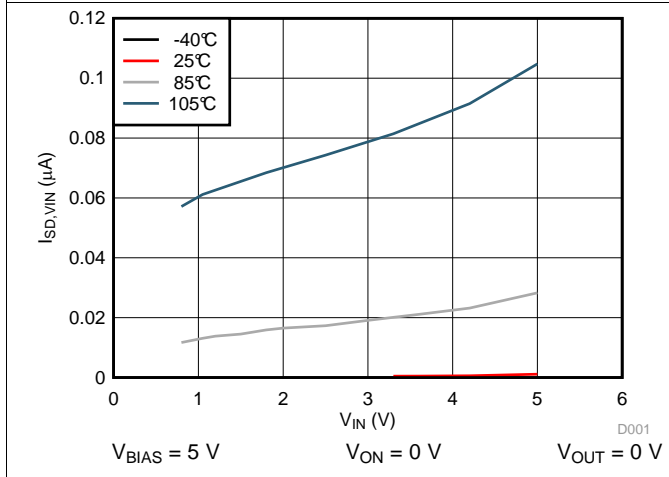

Figure 4. $I_{SD,VIN}$ vs V_{IN}

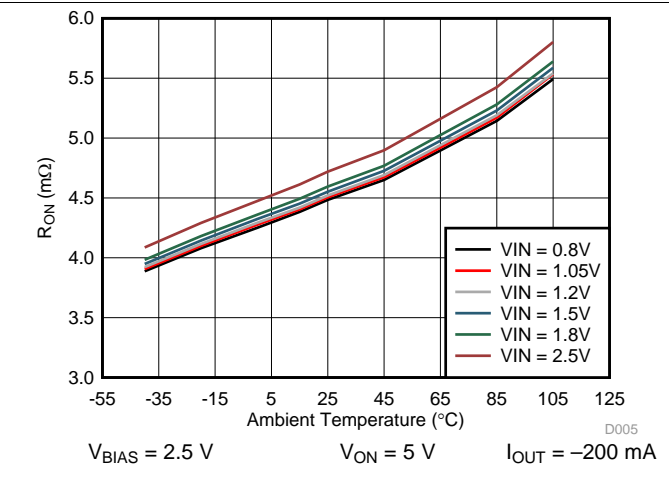

Figure 5. R_{ON} vs Ambient Temperature

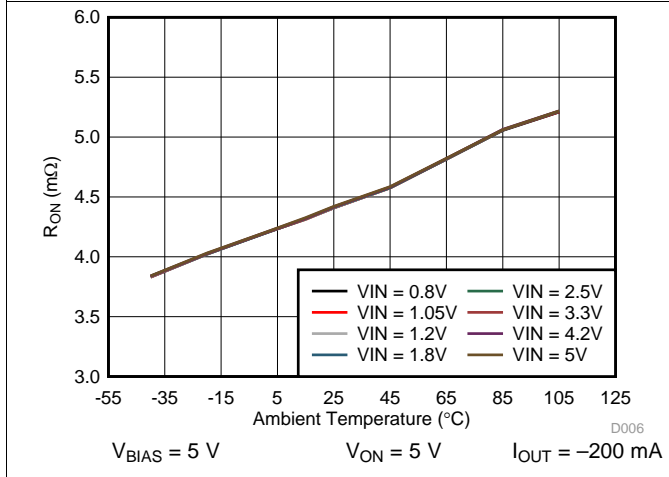

Figure 6. R_{ON} vs Ambient Temperature

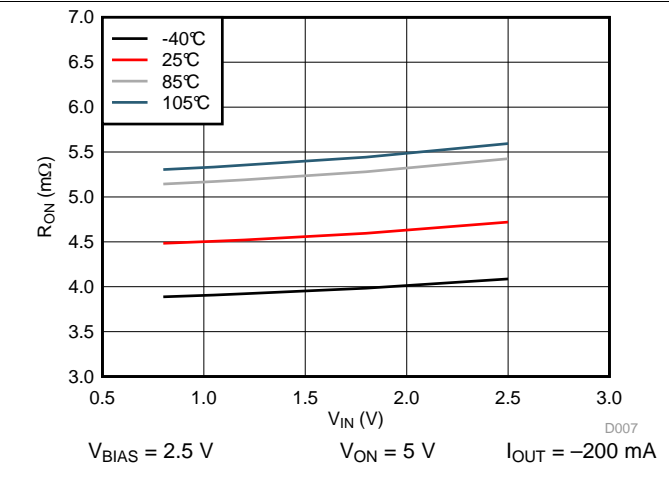
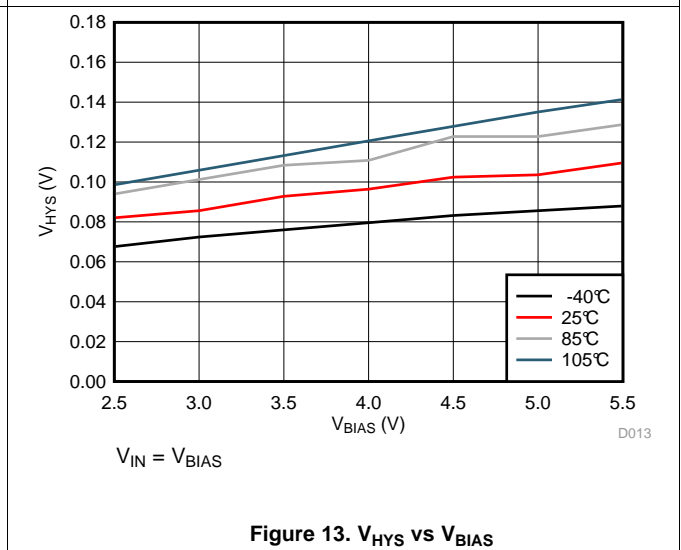
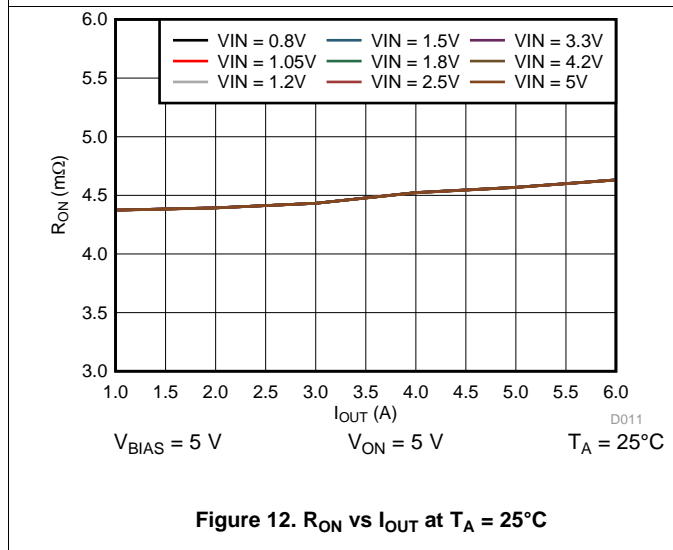
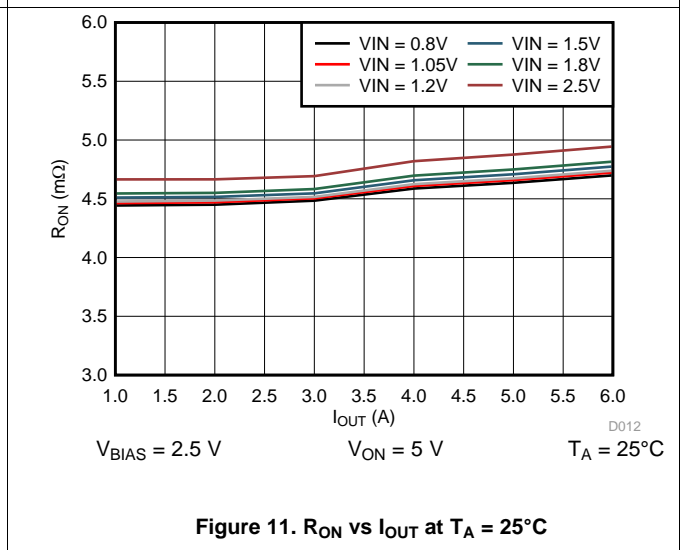
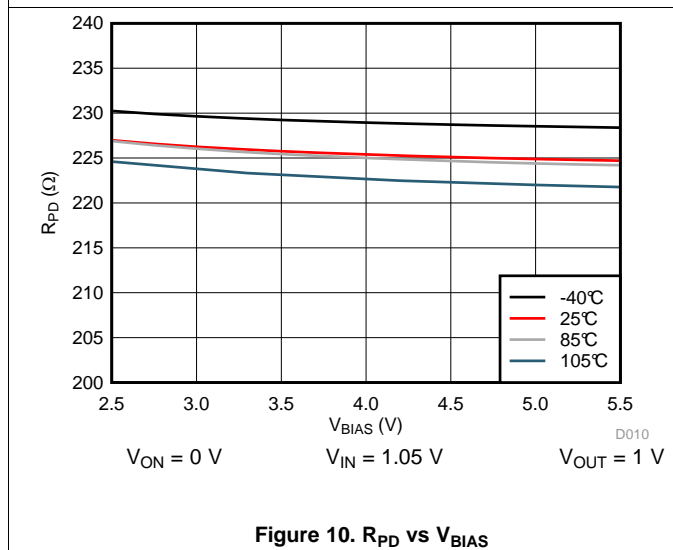
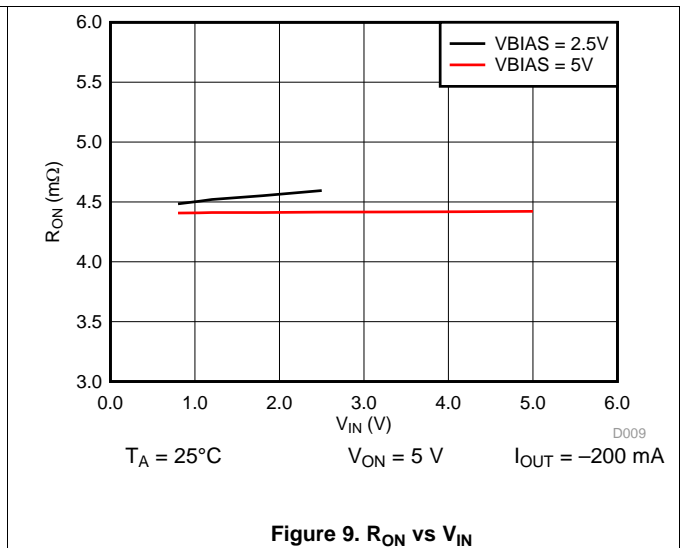
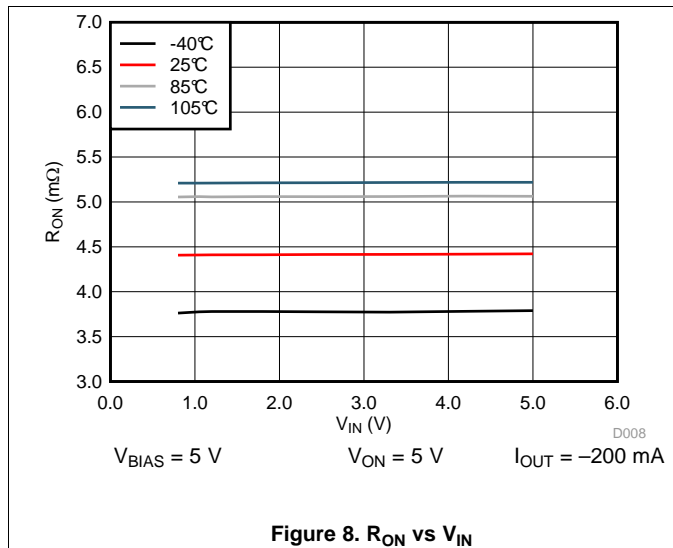
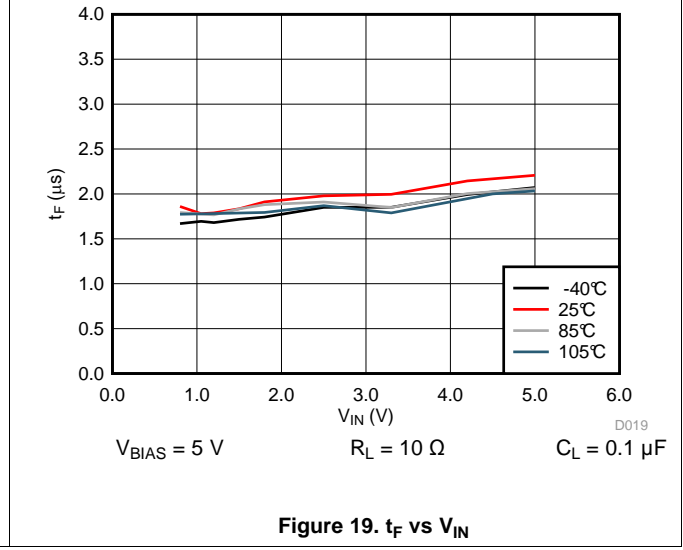
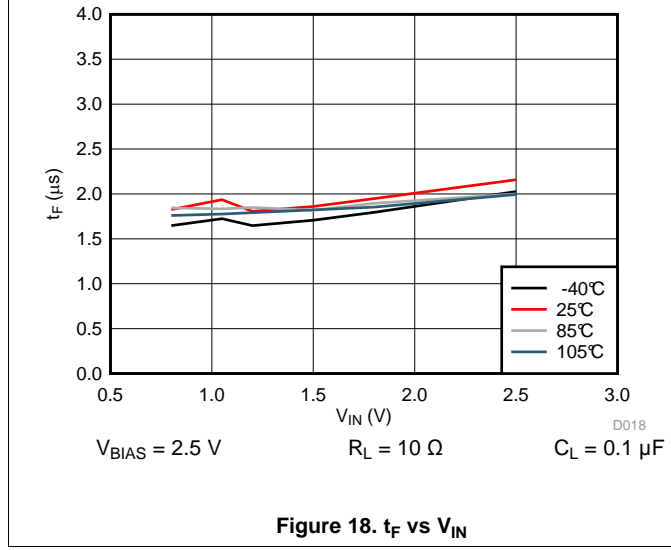
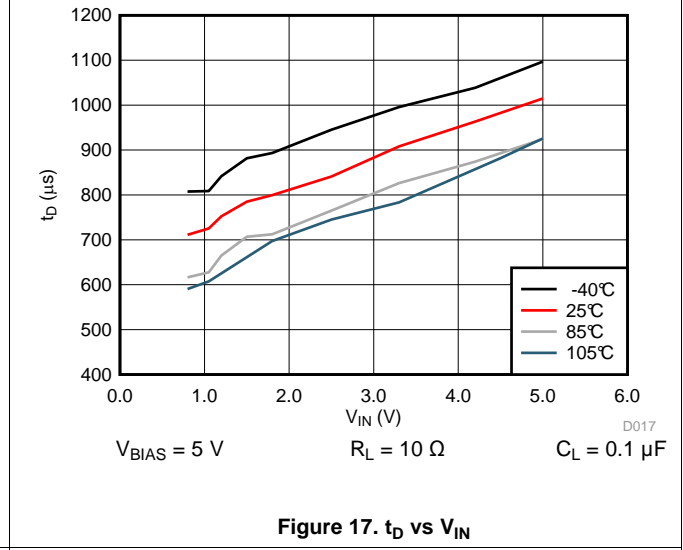
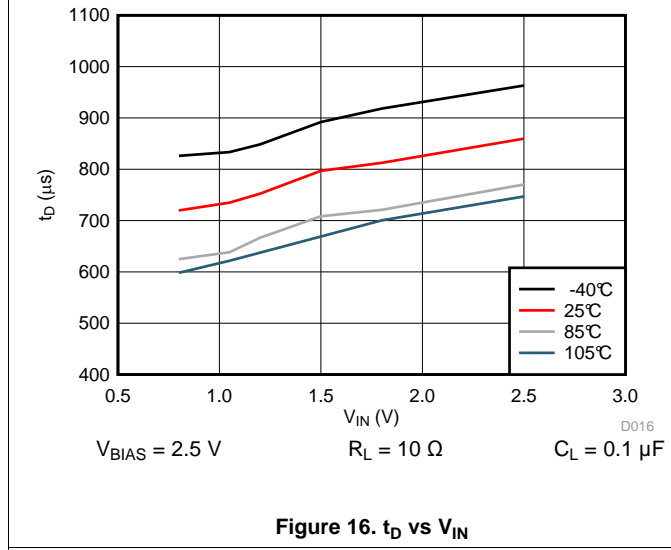
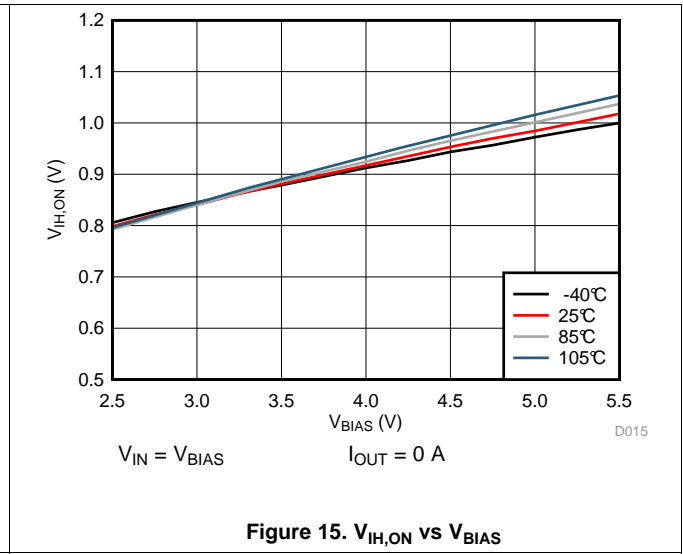
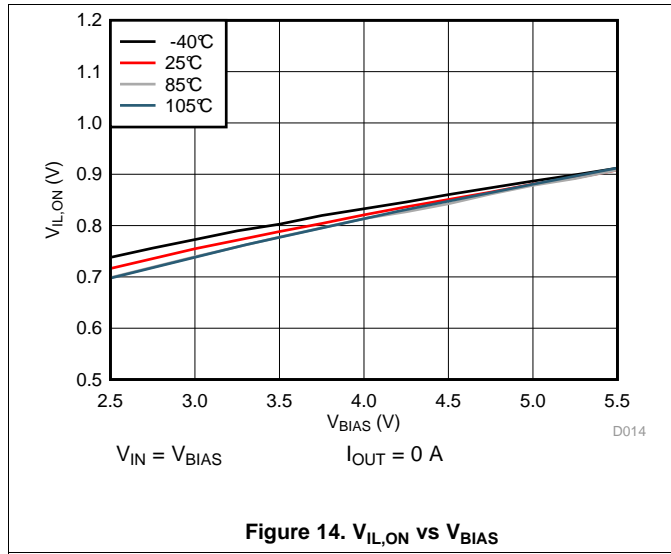

Figure 7. R_{ON} vs V_{IN}

Typical Characteristics (continued)



Typical Characteristics (continued)



Typical Characteristics (continued)

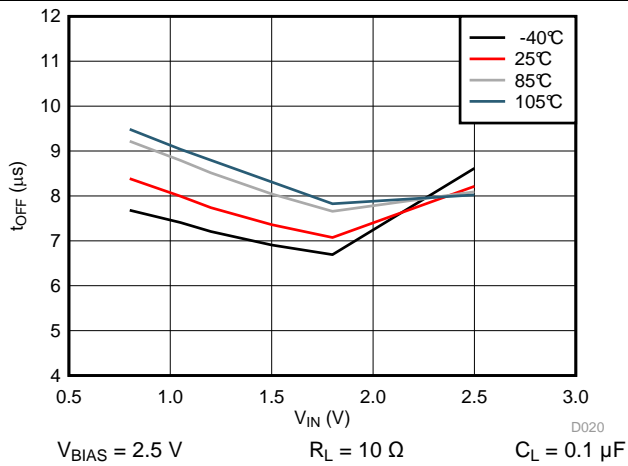

Figure 20. t_{OFF} vs V_{IN}

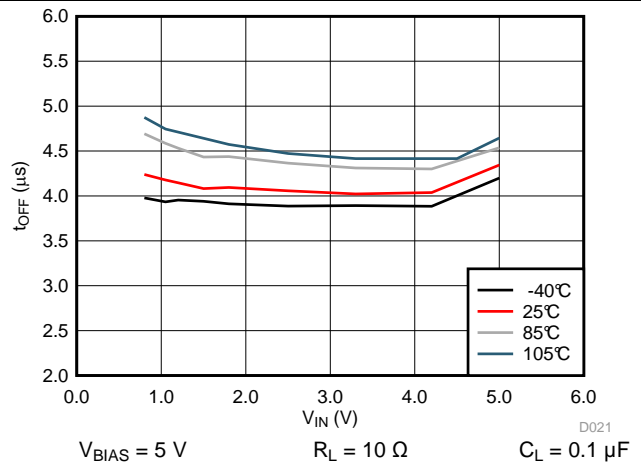

Figure 21. t_{OFF} vs V_{IN}

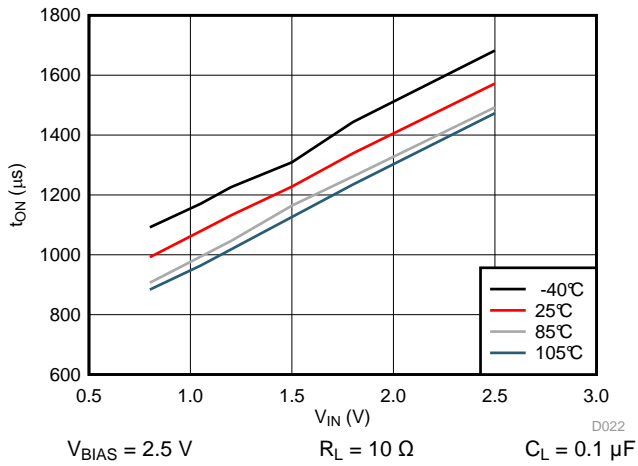

Figure 22. t_{ON} vs V_{IN}

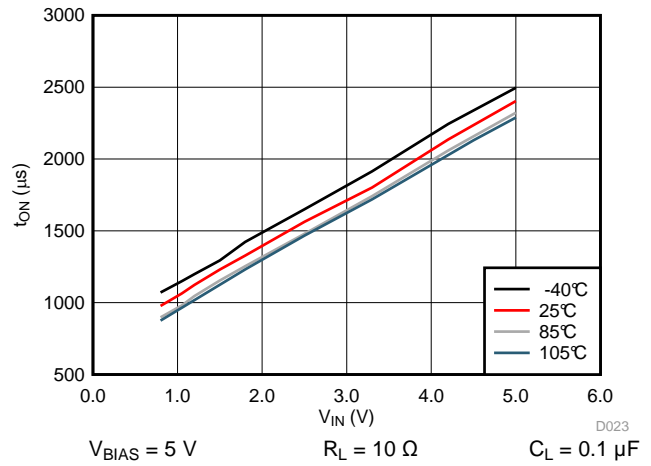

Figure 23. t_{ON} vs V_{IN}

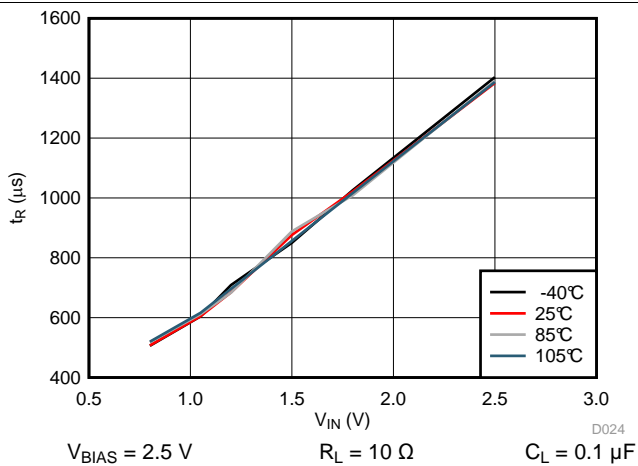

Figure 24. t_R vs V_{IN}

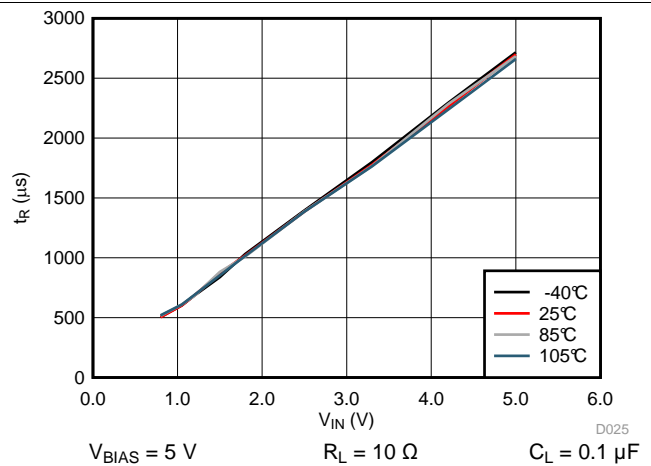
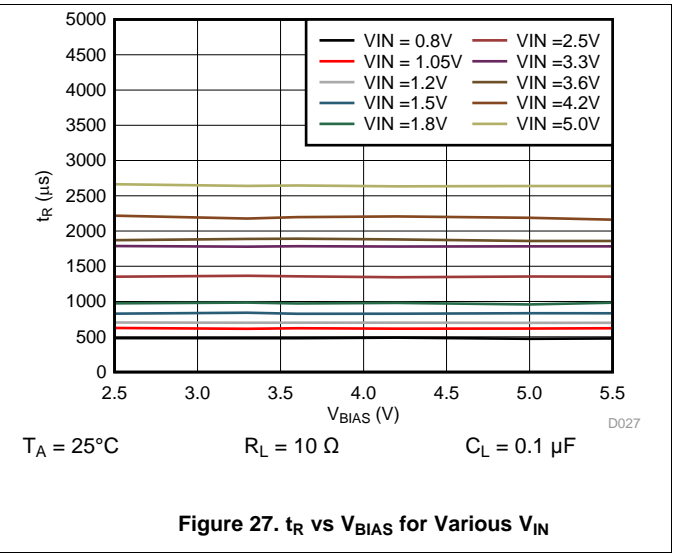
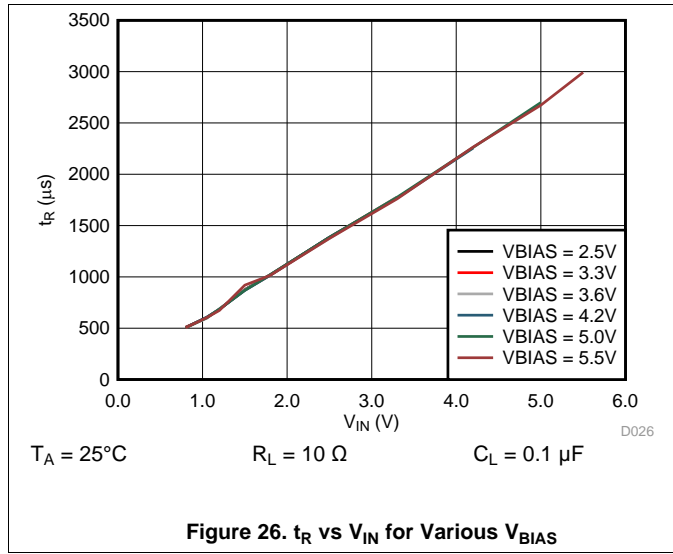

Figure 25. t_R vs V_{IN}

Typical Characteristics (continued)



7 Detailed Description

7.1 Overview

The device is a 5.5 V, 6 A load switch in a 8-pin SON package. To reduce voltage drop for low voltage and high current rails, the device implements an ultra-low resistance N-channel MOSFET which reduces the drop out voltage through the device.

The device has a controlled and fixed slew rate which helps reduce or eliminate power supply droop due to large inrush currents. During shutdown, the device has very low leakage currents, thereby reducing unnecessary leakages for downstream modules during standby. Integrated control logic, driver, charge pump, and output discharge FET eliminates the need for any external components, which reduces solution size and BOM count.

7.2 Functional Block Diagram

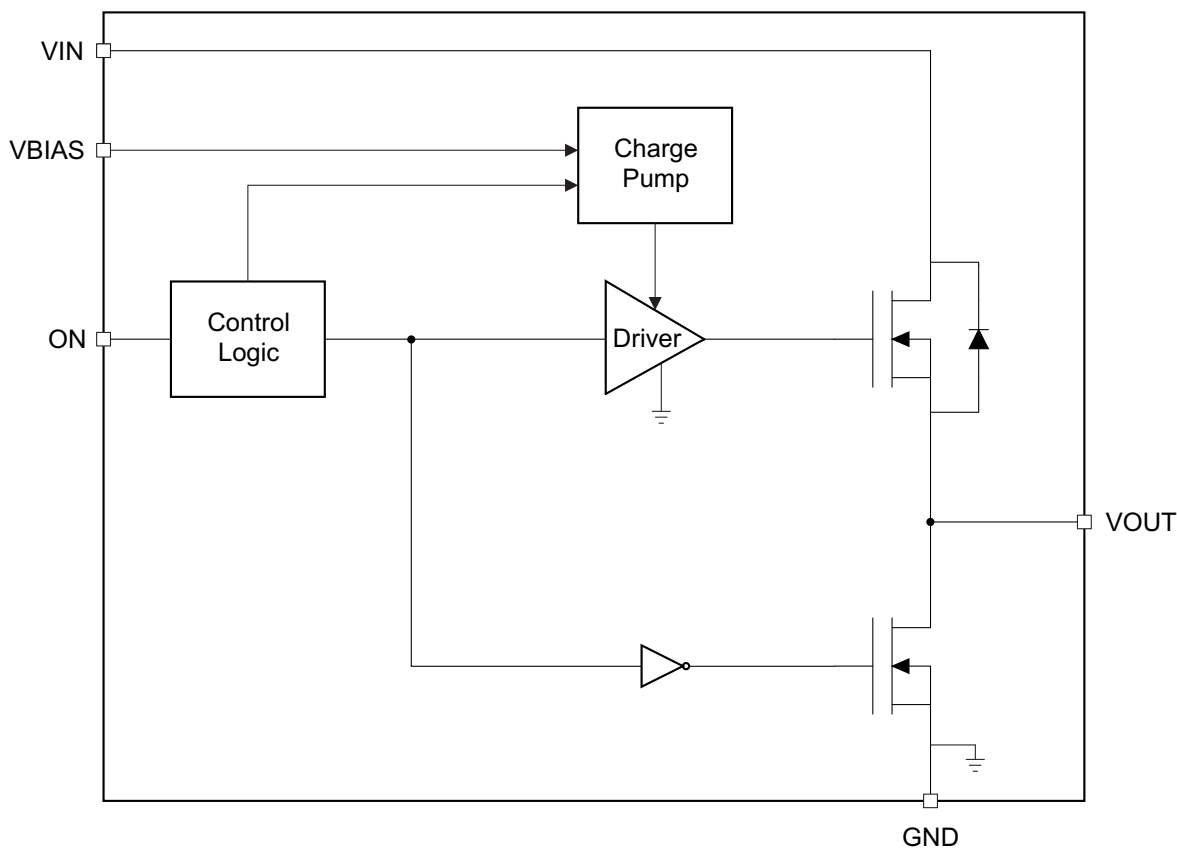

7.3 Feature Description

7.3.1 On/off Control

The ON pin controls the state of the load switch, and asserting the pin high (active high) enables the switch. The ON pin is compatible with standard GPIO logic threshold and can be used with any microcontroller or discrete logic with 1.2-V or higher GPIO voltage. This pin cannot be left floating and must be tied either high or low for proper functionality.

7.3.2 Input Capacitor (C_{IN})

To limit the voltage drop on the input supply caused by transient in-rush currents when the switch turns on into a discharged load capacitor or short-circuit, a capacitor needs to be placed between V_{IN} and GND. A 1- μ F ceramic capacitor, C_{IN} , placed close to the pins, is usually sufficient. Higher values of C_{IN} can be used to further reduce the voltage drop in high-current application. When switching heavy loads, it is recommended to have an input capacitor 10 times higher than the output capacitor to avoid excessive voltage drop; however, a 10 to 1 ratio for capacitance is not required for proper functionality of the device, but a ratio smaller than 10 to 1 (such as 1 to 1) could cause a V_{IN} dip upon turn-on due to inrush currents based on external factor such as board parasitics and output bulk capacitance.

7.3.3 Output Capacitor (C_L)

Due to the integrated body diode in the N-channel MOSFET, a C_{IN} greater than C_L is highly recommended. A C_L greater than C_{IN} can cause V_{OUT} to exceed V_{IN} when the system supply is removed. This could result in current flow through the body diode from V_{OUT} to V_{IN} . A C_{IN} to C_L ratio of 10 to 1 is recommended for minimizing V_{IN} dip caused by inrush currents during startup, however a 10 to 1 ratio for capacitance is not required for proper functionality of the device. A ratio smaller than 10 to 1 (such as 1 to 1) could cause a V_{IN} dip upon turn-on due to inrush currents based on external factor such as board parasitics and output bulk capacitance.

7.3.4 V_{IN} and V_{BIAS} Voltage Range

For optimal R_{ON} performance, make sure $V_{IN} \leq V_{BIAS}$. The device may still be functional if $V_{IN} > V_{BIAS}$ but it will exhibit R_{ON} greater than what is listed in the Electrical Characteristics table. See Figure 28 for an example of a typical device. Notice the increasing R_{ON} as V_{IN} increases. Be sure to never exceed the maximum voltage rating for V_{IN} and V_{BIAS} . Performance of the device is not guaranteed for $V_{IN} > V_{BIAS}$.

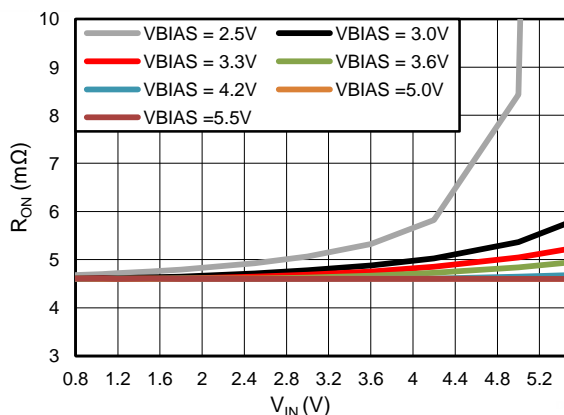

Figure 28. R_{ON} vs V_{IN} ($V_{IN} > V_{BIAS}$)

8 Applications and Implementation

NOTE

Information in the following applications sections is not part of the TI component specification, and TI does not warrant its accuracy or completeness. TI's customers are responsible for determining suitability of components for their purposes. Customers should validate and test their design implementation to confirm system functionality.

8.1 Application Information

This section will highlight some of the design considerations when implementing this device in various applications. A PSPICE model for this device is also available in the product page of this device.

8.2 Typical Application

This application demonstrates how the TPS22969 can be used to power downstream modules with large capacitances. The example below is powering a 100- μ F capacitive output load.

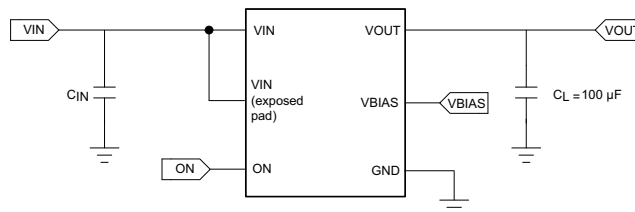

Figure 29. Typical Application Schematic for Powering a Downstream Module

8.2.1 Design Requirements

For this design example, use [Table 1](#) as the input parameters.

Table 1. Design Parameters

DESIGN PARAMETER	EXAMPLE VALUE
V_{IN}	1.05 V
V_{BIAS}	5.0 V
Load current	6 A

8.2.2 Detailed Design Procedure

To begin the design process, the designer needs to know the following:

- V_{IN} voltage
- V_{BIAS} voltage
- Load current

8.2.2.1 V_{IN} to V_{OUT} Voltage Drop

The V_{IN} to V_{OUT} voltage drop in the device is determined by the R_{ON} of the device and the load current. The R_{ON} of the device depends upon the V_{IN} and V_{BIAS} conditions of the device. Refer to the R_{ON} specification of the device in the [Electrical Characteristics](#), $V_{BIAS} = 5.0$ V tables of this datasheet. Once the R_{ON} of the device is determined based upon the V_{IN} and V_{BIAS} conditions, use [Equation 1](#) to calculate the V_{IN} to V_{OUT} voltage drop:

$$\Delta V = I_{LOAD} \times R_{ON} \quad (1)$$

where

- ΔV = voltage drop from V_{IN} to V_{OUT}
- I_{LOAD} = load current
- R_{ON} = on-resistance of the device for a specific V_{IN} and V_{BIAS} combination

An appropriate I_{LOAD} must be chosen such that the I_{MAX} specification of the device is not violated.

8.2.2.2 Inrush Current

To determine how much inrush current will be caused by the C_L capacitor, use Equation 2:

$$I_{\text{INRUSH}} = C_L \times \frac{dV_{\text{OUT}}}{dt} \tag{2}$$

where

- I_{INRUSH} = amount of inrush caused by C_L
- C_L = capacitance on VOUT
- dt = time it takes for change in V_{OUT} during the ramp up of VOUT when the device is enabled
- dV_{OUT} = change in V_{OUT} during the ramp up of VOUT when the device is enabled

An appropriate C_L value should be placed on VOUT such that the I_{MAX} and I_{PLS} specifications of the device are not violated.

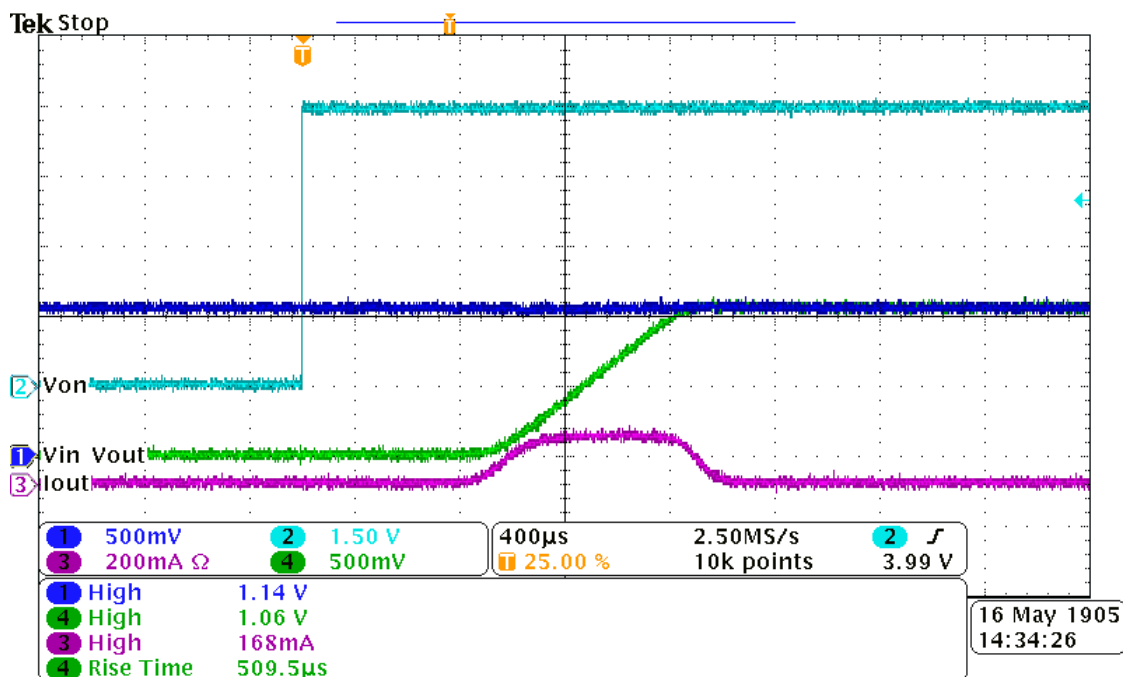

Figure 30. Inrush current ($V_{\text{BIAS}} = 5 \text{ V}$, $V_{\text{IN}} = 1.05 \text{ V}$, $C_L = 100 \mu\text{F}$)

8.2.2.3 Thermal Considerations

The maximum IC junction temperature should be restricted to 125°C under normal operating conditions. To calculate the maximum allowable dissipation, $P_{\text{D(max)}}$ for a given output current and ambient temperature, use Equation 3.

$$P_{\text{D(MAX)}} = \frac{T_{\text{J(MAX)}} - T_{\text{A}}}{R_{\theta\text{JA}}} \tag{3}$$

where

- $P_{\text{D(max)}}$ = maximum allowable power dissipation
- $T_{\text{J(max)}}$ = maximum allowable junction temperature (125°C for the TPS22969)
- T_{A} = ambient temperature of the device
- Θ_{JA} = junction to air thermal impedance. See Thermal Information section. This parameter is highly dependent upon board layout.

8.2.3 Application Curves

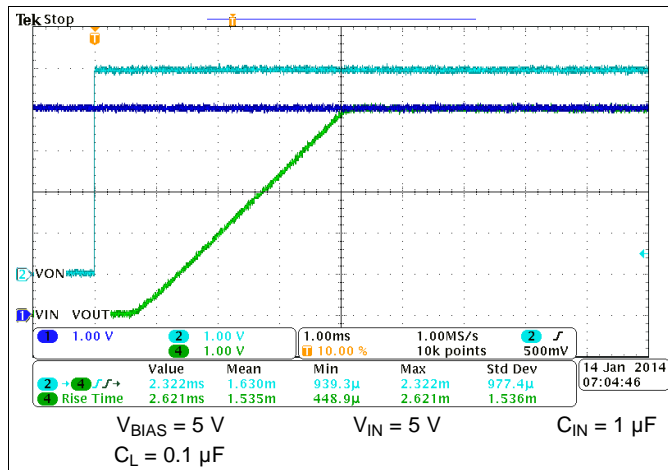

Figure 31. t_R at $V_{BIAS} = 5\text{ V}$

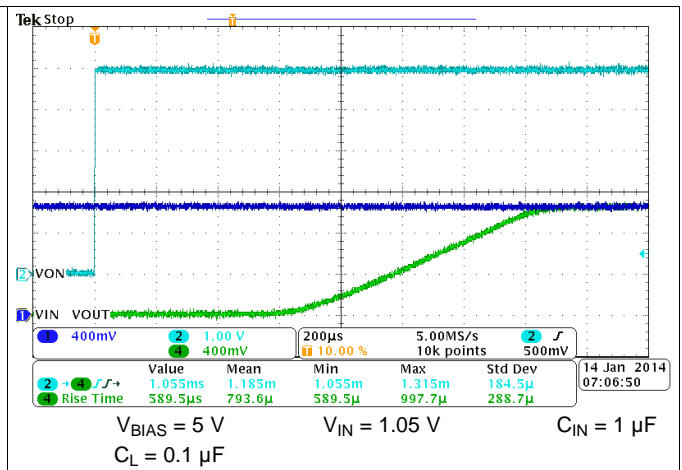

Figure 32. t_R at $V_{BIAS} = 5\text{ V}$

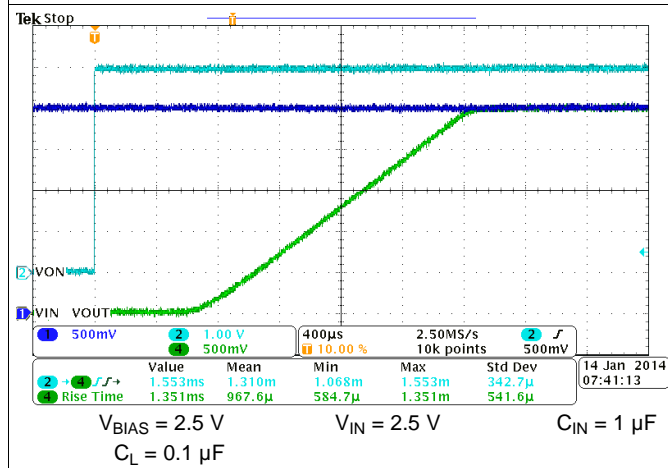

Figure 33. t_R at $V_{BIAS} = 2.5\text{ V}$

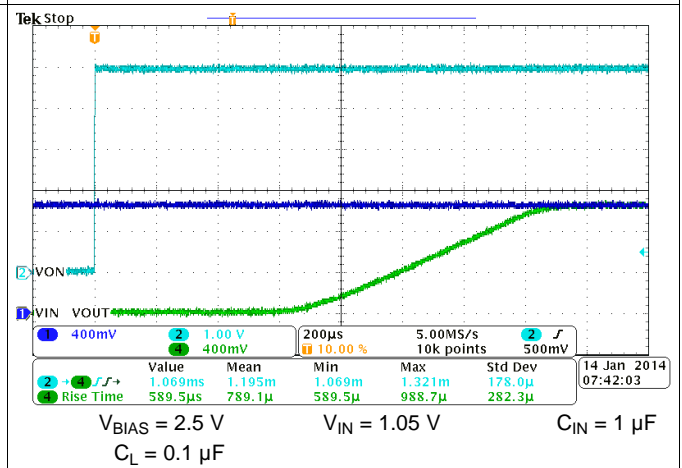

Figure 34. t_R at $V_{BIAS} = 2.5\text{ V}$

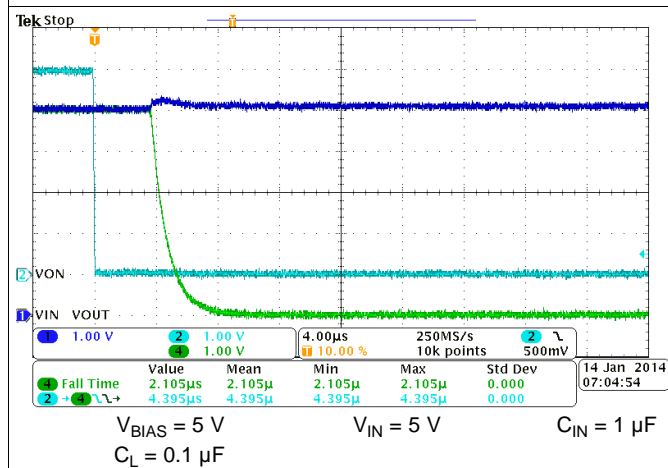

Figure 35. t_F at $V_{BIAS} = 5\text{ V}$

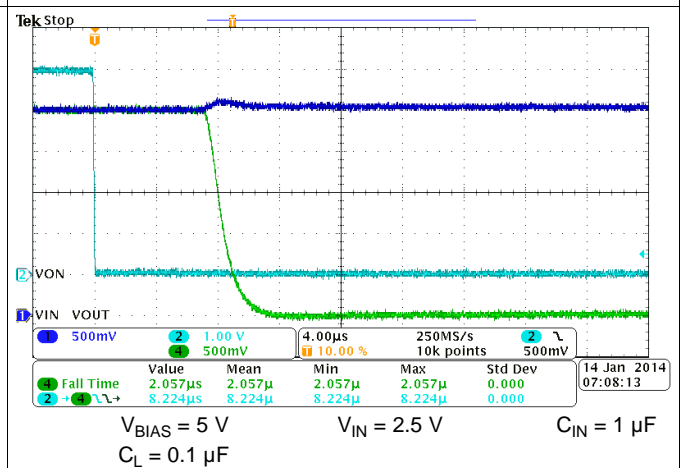
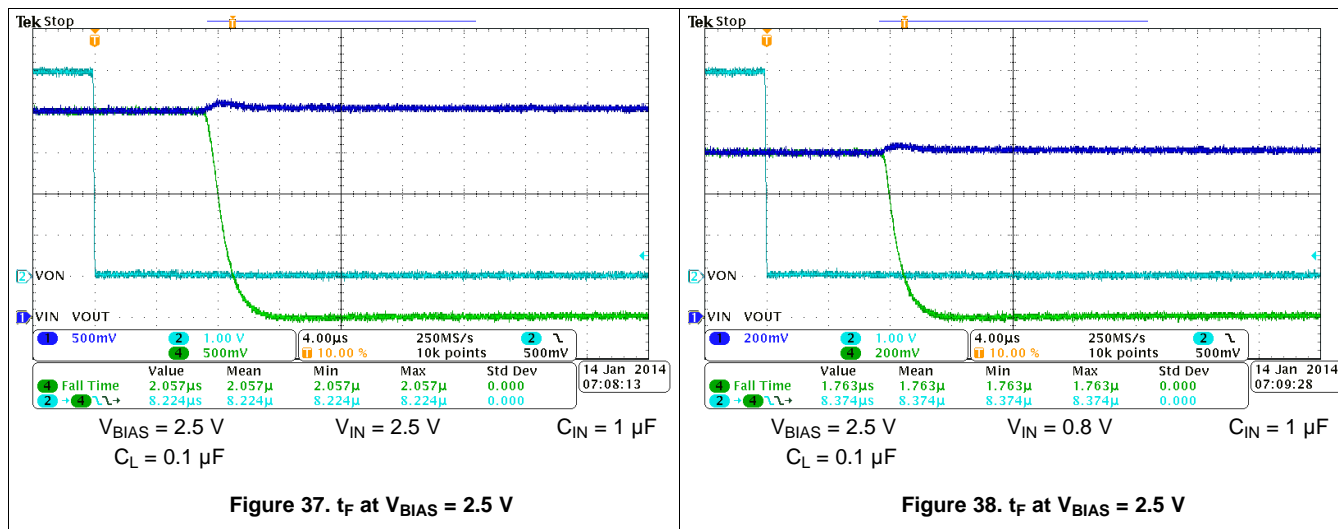

Figure 36. t_F at $V_{BIAS} = 5\text{ V}$



9 Power Supply Recommendations

The device is designed to operate from a V_{BIAS} range of 2.5 V to 5.5 V and V_{IN} range of 0.8 V to 5.5 V. This supply must be well regulated and placed as close to the device pin as possible with the recommended 1- μF bypass capacitor. If the supply is located more than a few inches from the device pins, additional bulk capacitance may be required in addition to the ceramic bypass capacitors. If additional bulk capacitance is required, an electrolytic, tantalum, or ceramic capacitor of 10 μF may be sufficient.

10 Layout

10.1 Layout Guidelines

- V_{IN} and V_{OUT} traces should be as short and wide as possible to accommodate for high current.
- Use vias under the exposed thermal pad for thermal relief for high current operation.
- The V_{IN} pin should be bypassed to ground with low ESR ceramic bypass capacitors. The typical recommended bypass capacitance is 1- μF ceramic with X5R or X7R dielectric. This capacitor should be placed as close to the device pins as possible.
- The V_{OUT} pin should be bypassed to ground with low ESR ceramic bypass capacitors. The typical recommended bypass capacitance is one-tenth of the V_{IN} bypass capacitor of X5R or X7R dielectric rating. This capacitor should be placed as close to the device pins as possible.
- The V_{BIAS} pin should be bypassed to ground with low ESR ceramic bypass capacitors. The typical recommended bypass capacitance is 0.1- μF ceramic with X5R or X7R dielectric.

10.2 Layout Example

○ VIA to Power Ground Plane

⊖ VIA to VIN Plane

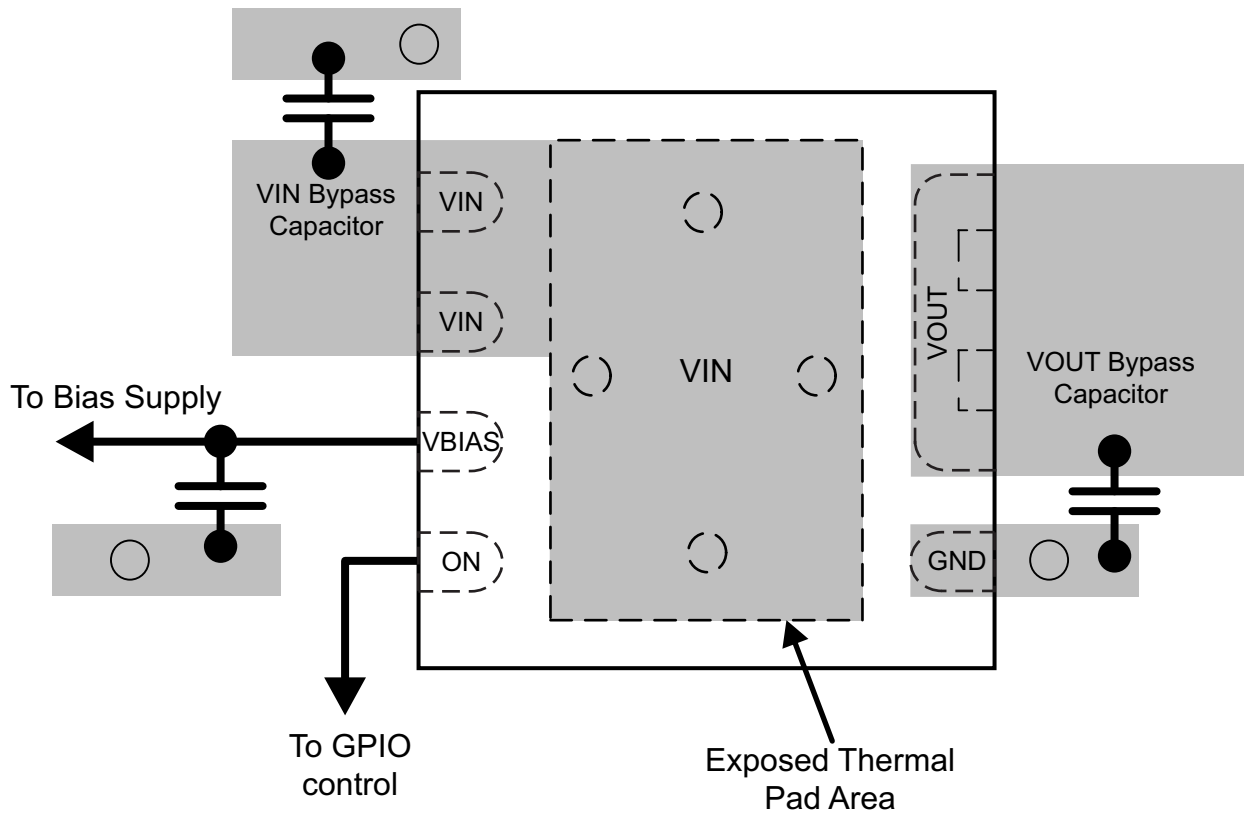

Figure 39. Recommended Board Layout

11 Device and Documentation Support

11.1 Community Resources

The following links connect to TI community resources. Linked contents are provided "AS IS" by the respective contributors. They do not constitute TI specifications and do not necessarily reflect TI's views; see TI's [Terms of Use](#).

TI E2E™ Online Community *TI's Engineer-to-Engineer (E2E) Community*. Created to foster collaboration among engineers. At e2e.ti.com, you can ask questions, share knowledge, explore ideas and help solve problems with fellow engineers.

Design Support *TI's Design Support* Quickly find helpful E2E forums along with design support tools and contact information for technical support.

11.2 Trademarks

E2E is a trademark of Texas Instruments.

Ultrabook is a trademark of Intel.

All other trademarks are the property of their respective owners.

11.3 Electrostatic Discharge Caution



These devices have limited built-in ESD protection. The leads should be shorted together or the device placed in conductive foam during storage or handling to prevent electrostatic damage to the MOS gates.

11.4 Glossary

[SLYZ022](#) — *TI Glossary*.

This glossary lists and explains terms, acronyms, and definitions.

12 Mechanical, Packaging, and Orderable Information

The following pages include mechanical, packaging, and orderable information. This information is the most current data available for the designated devices. This data is subject to change without notice and revision of this document. For browser-based versions of this data sheet, refer to the left-hand navigation.

PACKAGING INFORMATION

Orderable Device	Status (1)	Package Type	Package Drawing	Pins	Package Qty	Eco Plan (2)	Lead/Ball Finish (6)	MSL Peak Temp (3)	Op Temp (°C)	Device Marking (4/5)	Samples
TPS22969DNYR	ACTIVE	WSO	DNY	8	3000	Green (RoHS & no Sb/Br)	CU NIPDAU	Level-2-260C-1 YEAR	-40 to 85	969A0	Samples
TPS22969DNYT	ACTIVE	WSO	DNY	8	250	Green (RoHS & no Sb/Br)	CU NIPDAU	Level-2-260C-1 YEAR	-40 to 85	969A0	Samples

(1) The marketing status values are defined as follows:

ACTIVE: Product device recommended for new designs.

LIFEBUY: TI has announced that the device will be discontinued, and a lifetime-buy period is in effect.

NRND: Not recommended for new designs. Device is in production to support existing customers, but TI does not recommend using this part in a new design.

PREVIEW: Device has been announced but is not in production. Samples may or may not be available.

OBSELETE: TI has discontinued the production of the device.

(2) Eco Plan - The planned eco-friendly classification: Pb-Free (RoHS), Pb-Free (RoHS Exempt), or Green (RoHS & no Sb/Br) - please check <http://www.ti.com/productcontent> for the latest availability information and additional product content details.

TBD: The Pb-Free/Green conversion plan has not been defined.

Pb-Free (RoHS): TI's terms "Lead-Free" or "Pb-Free" mean semiconductor products that are compatible with the current RoHS requirements for all 6 substances, including the requirement that lead not exceed 0.1% by weight in homogeneous materials. Where designed to be soldered at high temperatures, TI Pb-Free products are suitable for use in specified lead-free processes.

Pb-Free (RoHS Exempt): This component has a RoHS exemption for either 1) lead-based flip-chip solder bumps used between the die and package, or 2) lead-based die adhesive used between the die and leadframe. The component is otherwise considered Pb-Free (RoHS compatible) as defined above.

Green (RoHS & no Sb/Br): TI defines "Green" to mean Pb-Free (RoHS compatible), and free of Bromine (Br) and Antimony (Sb) based flame retardants (Br or Sb do not exceed 0.1% by weight in homogeneous material)

(3) MSL, Peak Temp. - The Moisture Sensitivity Level rating according to the JEDEC industry standard classifications, and peak solder temperature.

(4) There may be additional marking, which relates to the logo, the lot trace code information, or the environmental category on the device.

(5) Multiple Device Markings will be inside parentheses. Only one Device Marking contained in parentheses and separated by a "~" will appear on a device. If a line is indented then it is a continuation of the previous line and the two combined represent the entire Device Marking for that device.

(6) Lead/Ball Finish - Orderable Devices may have multiple material finish options. Finish options are separated by a vertical ruled line. Lead/Ball Finish values may wrap to two lines if the finish value exceeds the maximum column width.

Important Information and Disclaimer:The information provided on this page represents TI's knowledge and belief as of the date that it is provided. TI bases its knowledge and belief on information provided by third parties, and makes no representation or warranty as to the accuracy of such information. Efforts are underway to better integrate information from third parties. TI has taken and continues to take reasonable steps to provide representative and accurate information but may not have conducted destructive testing or chemical analysis on incoming materials and chemicals. TI and TI suppliers consider certain information to be proprietary, and thus CAS numbers and other limited information may not be available for release.

In no event shall TI's liability arising out of such information exceed the total purchase price of the TI part(s) at issue in this document sold by TI to Customer on an annual basis.

TAPE AND REEL INFORMATION



QUADRANT ASSIGNMENTS FOR PIN 1 ORIENTATION IN TAPE



*All dimensions are nominal

Device	Package Type	Package Drawing	Pins	SPQ	Reel Diameter (mm)	Reel Width W1 (mm)	A0 (mm)	B0 (mm)	K0 (mm)	P1 (mm)	W (mm)	Pin1 Quadrant
TPS22969DNYR	WSON	DNY	8	3000	330.0	12.4	3.3	3.3	1.0	8.0	12.0	Q2
TPS22969DNYT	WSON	DNY	8	250	180.0	12.4	3.3	3.3	1.0	8.0	12.0	Q2

TAPE AND REEL BOX DIMENSIONS

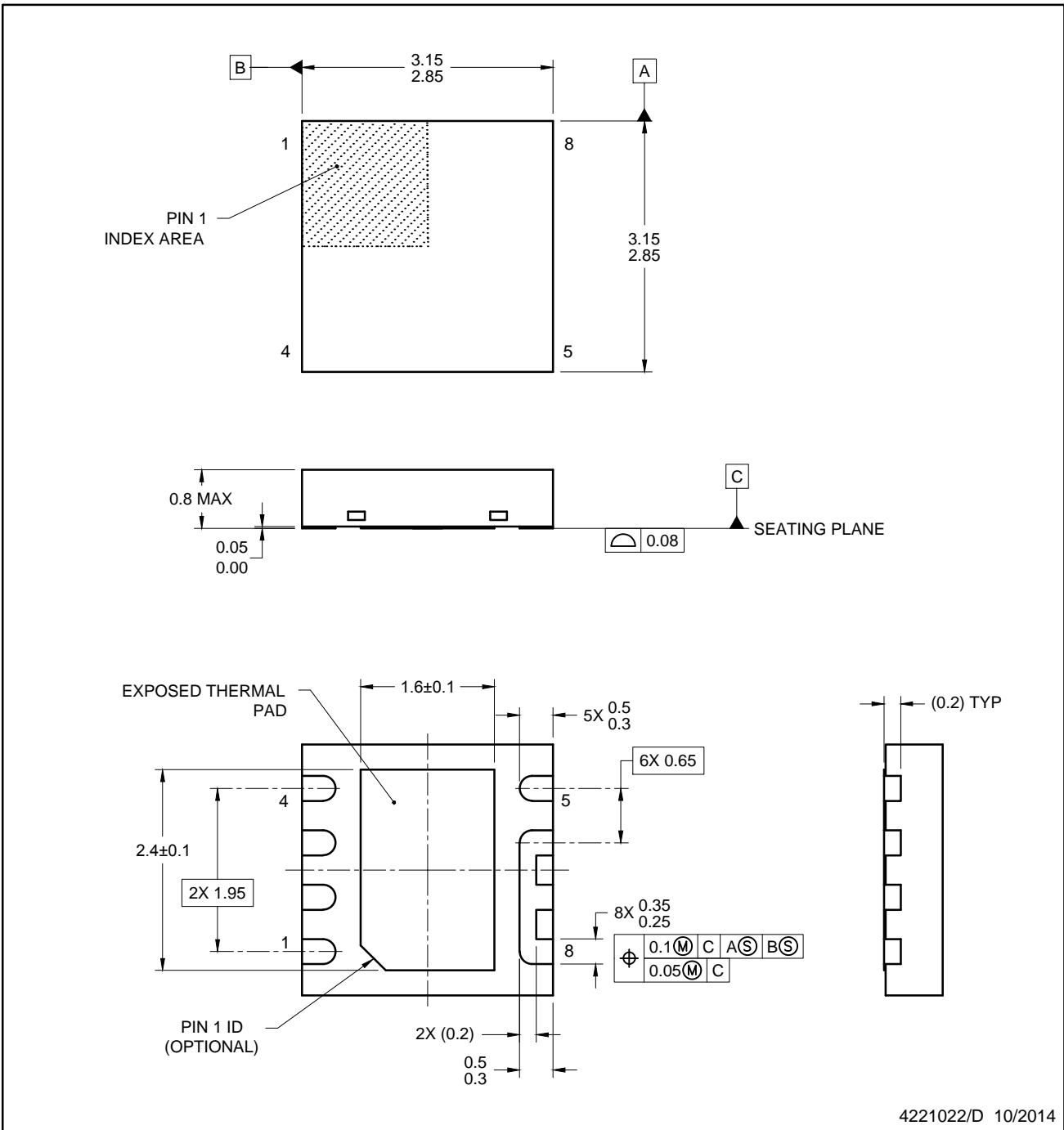

*All dimensions are nominal

Device	Package Type	Package Drawing	Pins	SPQ	Length (mm)	Width (mm)	Height (mm)
TPS22969DNYR	WSON	DNY	8	3000	370.0	355.0	55.0
TPS22969DNYT	WSON	DNY	8	250	195.0	200.0	45.0

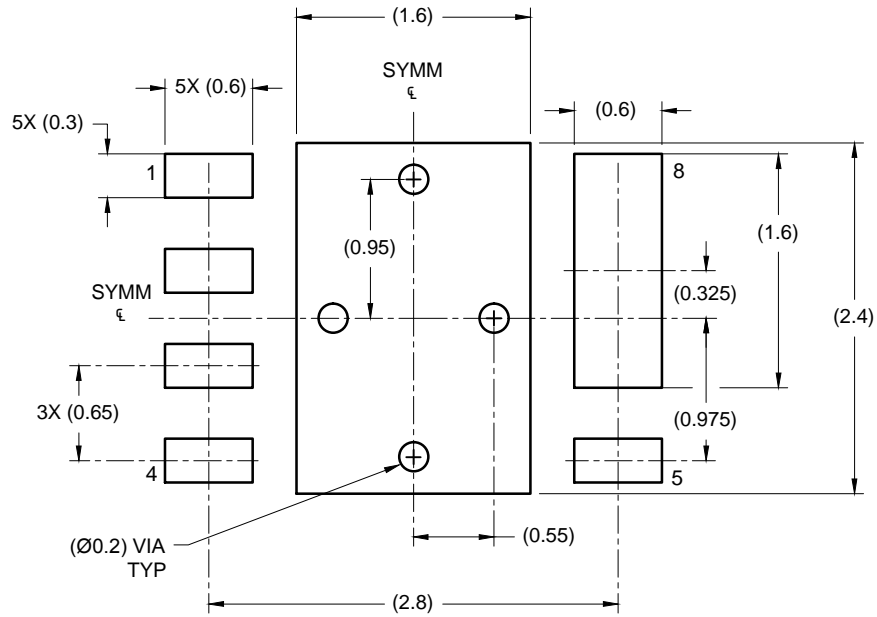

NOTES:

1. All linear dimensions are in millimeters. Any dimensions in parenthesis are for reference only. Dimensioning and tolerancing per ASME Y14.5M.
2. This drawing is subject to change without notice.
3. The package thermal pad must be soldered to the printed circuit board for thermal and mechanical performance.



LAND PATTERN EXAMPLE
SCALE: 20X

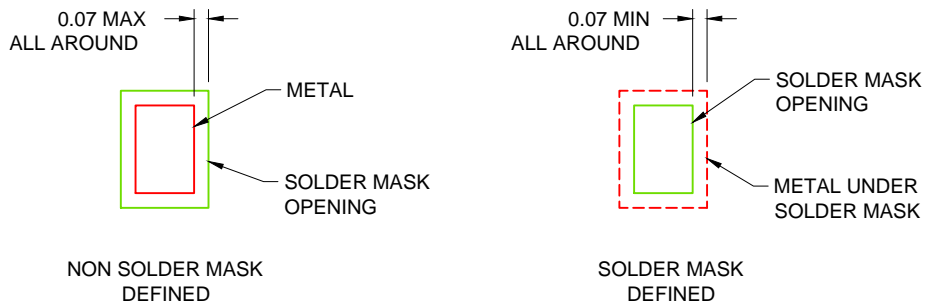

SOLDER MASK DETAILS

4221022/D 10/2014

NOTES: (continued)

4. This package is designed to be soldered to a thermal pad on the board. For more information, see Texas Instruments literature number SLUA271 (www.ti.com/lit/slua271).
5. Solder mask tolerances between and around signal pads can vary based on board fabrication site.

EXAMPLE STENCIL DESIGN

DNY0008A

WSON - 0.8 mm max height

PLASTIC SMALL OUTLINE - NO LEAD

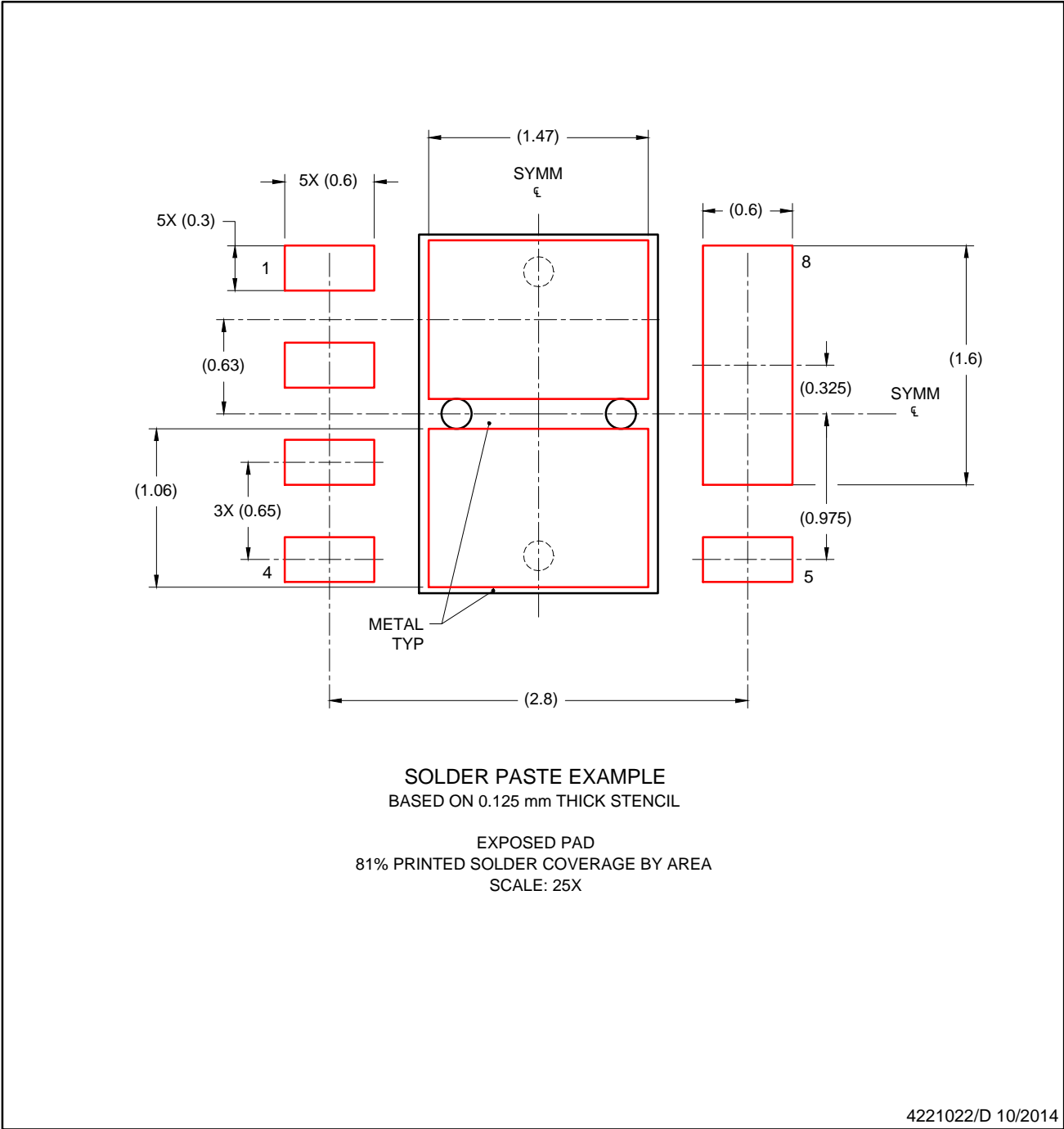

NOTES: (continued)

- 6. Laser cutting apertures with trapezoidal walls and rounded corners may offer better paste release. IPC-7525 may have alternate design recommendations.

IMPORTANT NOTICE

Texas Instruments Incorporated and its subsidiaries (TI) reserve the right to make corrections, enhancements, improvements and other changes to its semiconductor products and services per JESD46, latest issue, and to discontinue any product or service per JESD48, latest issue. Buyers should obtain the latest relevant information before placing orders and should verify that such information is current and complete. All semiconductor products (also referred to herein as "components") are sold subject to TI's terms and conditions of sale supplied at the time of order acknowledgment.

TI warrants performance of its components to the specifications applicable at the time of sale, in accordance with the warranty in TI's terms and conditions of sale of semiconductor products. Testing and other quality control techniques are used to the extent TI deems necessary to support this warranty. Except where mandated by applicable law, testing of all parameters of each component is not necessarily performed.

TI assumes no liability for applications assistance or the design of Buyers' products. Buyers are responsible for their products and applications using TI components. To minimize the risks associated with Buyers' products and applications, Buyers should provide adequate design and operating safeguards.

TI does not warrant or represent that any license, either express or implied, is granted under any patent right, copyright, mask work right, or other intellectual property right relating to any combination, machine, or process in which TI components or services are used. Information published by TI regarding third-party products or services does not constitute a license to use such products or services or a warranty or endorsement thereof. Use of such information may require a license from a third party under the patents or other intellectual property of the third party, or a license from TI under the patents or other intellectual property of TI.

Reproduction of significant portions of TI information in TI data books or data sheets is permissible only if reproduction is without alteration and is accompanied by all associated warranties, conditions, limitations, and notices. TI is not responsible or liable for such altered documentation. Information of third parties may be subject to additional restrictions.

Resale of TI components or services with statements different from or beyond the parameters stated by TI for that component or service voids all express and any implied warranties for the associated TI component or service and is an unfair and deceptive business practice. TI is not responsible or liable for any such statements.

Buyer acknowledges and agrees that it is solely responsible for compliance with all legal, regulatory and safety-related requirements concerning its products, and any use of TI components in its applications, notwithstanding any applications-related information or support that may be provided by TI. Buyer represents and agrees that it has all the necessary expertise to create and implement safeguards which anticipate dangerous consequences of failures, monitor failures and their consequences, lessen the likelihood of failures that might cause harm and take appropriate remedial actions. Buyer will fully indemnify TI and its representatives against any damages arising out of the use of any TI components in safety-critical applications.

In some cases, TI components may be promoted specifically to facilitate safety-related applications. With such components, TI's goal is to help enable customers to design and create their own end-product solutions that meet applicable functional safety standards and requirements. Nonetheless, such components are subject to these terms.

No TI components are authorized for use in FDA Class III (or similar life-critical medical equipment) unless authorized officers of the parties have executed a special agreement specifically governing such use.

Only those TI components which TI has specifically designated as military grade or "enhanced plastic" are designed and intended for use in military/aerospace applications or environments. Buyer acknowledges and agrees that any military or aerospace use of TI components which have **not** been so designated is solely at the Buyer's risk, and that Buyer is solely responsible for compliance with all legal and regulatory requirements in connection with such use.

TI has specifically designated certain components as meeting ISO/TS16949 requirements, mainly for automotive use. In any case of use of non-designated products, TI will not be responsible for any failure to meet ISO/TS16949.

Products

Audio	www.ti.com/audio
Amplifiers	amplifier.ti.com
Data Converters	dataconverter.ti.com
DLP® Products	www.dlp.com
DSP	dsp.ti.com
Clocks and Timers	www.ti.com/clocks
Interface	interface.ti.com
Logic	logic.ti.com
Power Mgmt	power.ti.com
Microcontrollers	microcontroller.ti.com
RFID	www.ti-rfid.com
OMAP Applications Processors	www.ti.com/omap
Wireless Connectivity	www.ti.com/wirelessconnectivity

Applications

Automotive and Transportation	www.ti.com/automotive
Communications and Telecom	www.ti.com/communications
Computers and Peripherals	www.ti.com/computers
Consumer Electronics	www.ti.com/consumer-apps
Energy and Lighting	www.ti.com/energy
Industrial	www.ti.com/industrial
Medical	www.ti.com/medical
Security	www.ti.com/security
Space, Avionics and Defense	www.ti.com/space-avionics-defense
Video and Imaging	www.ti.com/video

TI E2E Community

e2e.ti.com